

Auveco[®]

CONNECTING PARTS & PEOPLE

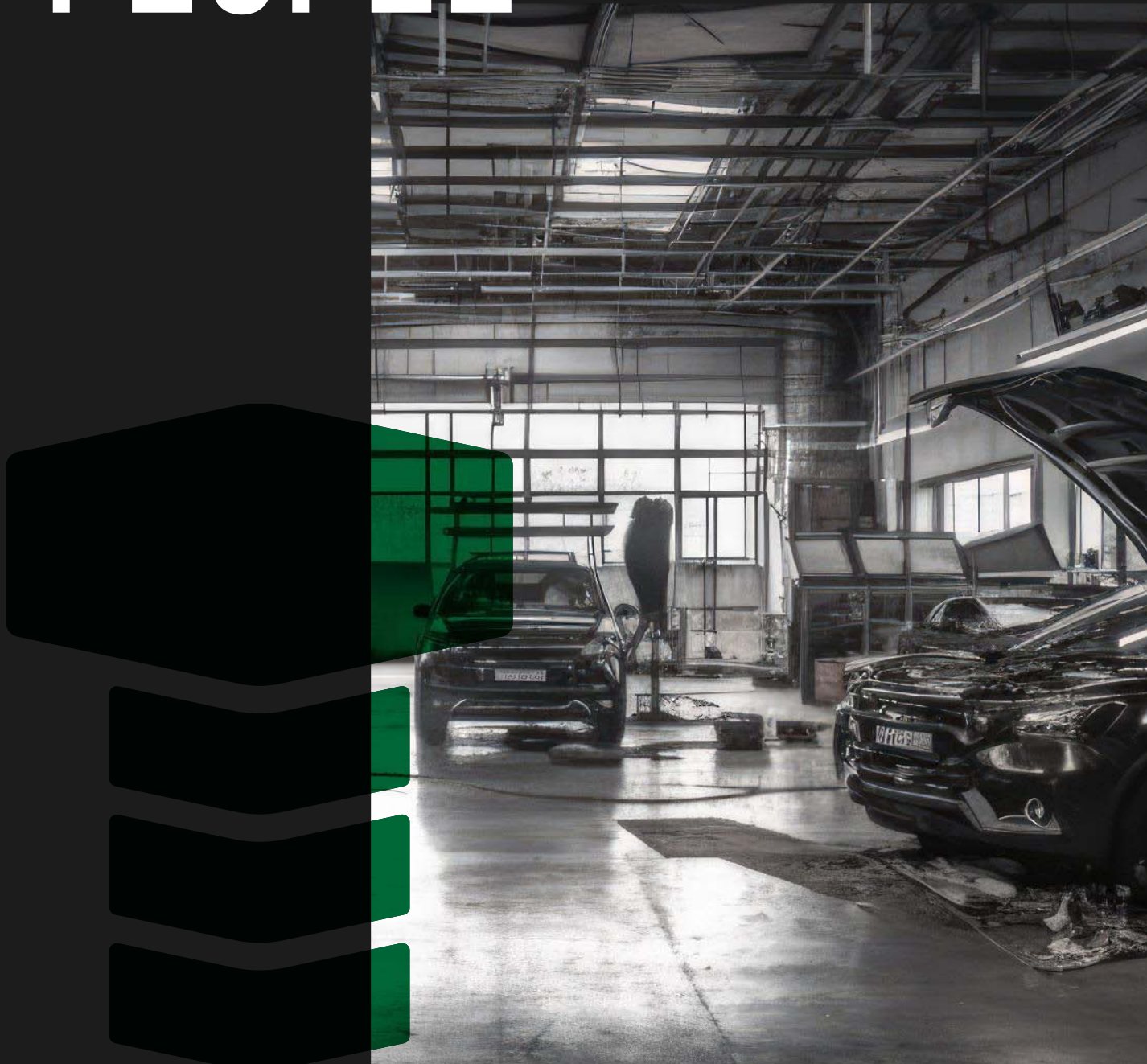

DISCOVER AUVECO



We continually invest in new programs and technology to better serve you.

- E-commerce site auveco.com
- EDI capabilities
- Warehouse fulfillment system for fast and accurate order delivery

We market our products through traditional channels of distribution, selling only to authorized Distributors and O.E. Manufacturers.

Ordering Made Easy



Visit us at
auveco.com
to place an order today.



NAVIGATING THE CATALOG

Quick Index: *A pictorial index*

- Picture examples to help you locate the pages of similar parts
- Section numbers correspond to the section numbers printed in the upper outside corner of each catalog page.

Alphabetical Index

- Allows you to check if we carry a specific product line.
- Popular categories are in bold type.

Numerical Index

- Gives you the capability to look up a part based on the Auveco part number

Helpful Tips

- All parts are displayed as actual size, unless labeled "not actual size" or is a picture accompanying a chart. As actual size you will be able to set a part on top of the picture to positively identify it.
- We have included Specification Charts to assist you in the identification of various types of fasteners. Charts can be found on the following pages:
 - Body Bolts- Pages: 38 & 80-81
 - Special Tapping Screws- Pages: 42-45 & 90-93
 - License Plate Screws- Pages: 63-64
 - Retainers- Pages: 509-523
 - Push-Type Retainers- Pages: 570-580

Charts list the pertinent dimensions, plating and color information, as well as the page number on which the actual size picture and application information is shown for each item.

- At the back of the catalog are two O.E.M. part number to Auveco part number Cross References.
- One of these interchanges is broken down by O.E. manufacturer i.e., General Motors, Ford, etc.
- The other interchange combines all O.E.M. numbers together and is sequenced strictly in alphanumeric order regardless of the manufacturer.

Screws Pages 19-74

Metric Items Pages 75-123

Nuts Pages 124-153

Washers, Shims & Retaining Rings Pages 154-164

Springs, Pins, Clips, Plug Buttons, Caps & Connectors Pages 164-175

Air Line Couplings & Accessories, Tubing and Hose Pages 175-176

Electrical Accessories Pages 177-298

Wire Loom & Clips and Cable & Harness Straps Pages 296-301

Oil & Transmission Drain Plugs & Gaskets and Grease Fittings & Accessories and Brass Fittings Pages 302-340

Rivets & Accessories and Drills & Sets Pages 338-368

Assortments, Cabinets, Bins & Racks Pages 369-420

O-Rings, Grommeting, Tire Valves, Weatherstrip, Rubber Bumpers & Grommets, Caps and Seals & Channels Pages 421-433

Glass Shop Supplies and Horns Pages 434-442

Trimming Sundries & Fasteners and Push-Type Retainers Pages 443-580

Domestic Car Clips & Fasteners Pages 581-667

Import Car Clips & Fasteners Pages 668-863

Universal Type Moulding Fasteners Pages 864-865

Ball Joint Assemblies, Yoke Ends and Clamps & Accessories Pages 866-876

Engine Manifold Repair Kit, Body Sealer and Epoxy Repair Kits Pages 877-878

Miscellaneous Items Pages 879-883

Tools Pages 884-890

QUICK INDEX

Photos not actual size

Section 1 Pages 19-26

Tapping & Wood Screws



Section 5 Pages 63-72

License Plate Screws & Fasteners



Section 2 Pages 27-35

Cap, Machine & Set Screws, Carriage, Frame & Stove Bolts and Stainless Steel Fasteners



Section 6 Pages 73-74

Cylinder Head & Manifold Studs



Section 3 Pages 36-41

Bumper & Body Bolts



Section 7 Pages 75-123

Metric Items



Section 4 Pages 42-62

Special Tapping Screws



Section 8 Pages 124-131

Standard, Special and Thread Cutting Nuts and Wheel Studs, Bolts & Nuts



QUICK INDEX

Photos not actual size

Section 9 Pages 132-153

Thread Repair Inserts, Teenut®, Expansion Nut & Rubber Nut, Tubular, Flat, U, & J-Nuts



Section 12 Pages 177-301

Electrical Accessories, Wire Loom & Clips, Cable Ties and Bulbs



Section 10 Pages 154-170

Washers, Shims, Retaining Rings, Springs, Pins, Yoke Ends, Spring Pins, Plugs and Straight & Woodruff Keys



Section 13 Pages 302-337

Oil Drain Plugs & Gaskets, Grease Fittings & Accessories and Brass Fittings



Section 11 Pages 171-176

Caps, Connectors, Airline Couplings & Accessories and Tubing & Hose

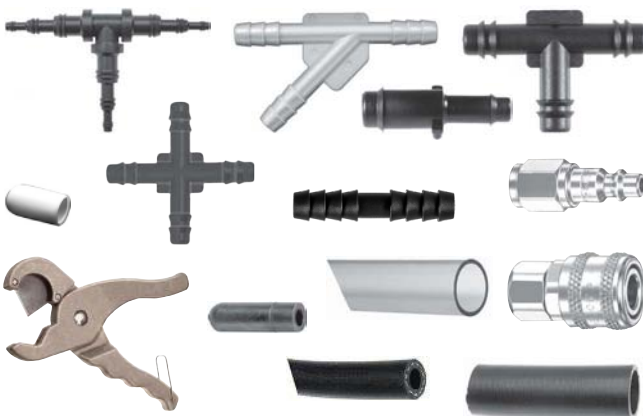

Section 14 Pages 338-368

Rivets & Tools and Drill Bits



QUICK INDEX

Photos not actual size

Section 15 Pages 369-420

AuvecoPaks, Assortments, Cabinets, Drawers and Special Racks



Section 16 Pages 421-433

O-Rings, Grommets, Tire Valves, Weatherstrip, Rubber Bumpers & Caps, Hold Down Straps and Glass Setting Channels



Section 17 Pages 434-440

Glass Shop Supplies



Section 18 Pages 441-442

Window Lift Motor Gears, Air Conditioning Motors and Horns



Section 19 Pages 443-580

Trimming Sundries & Fasteners, Snap & Curtain Fasteners, Push-Type Retainers and Truck Seat Springs



QUICK INDEX

Photos not actual size

Section 20 Pages 581-66 GM, Ford, Chrysler & AMC Clips and Fasteners



Section 22 Pages 864-865 Universal Moulding Fasteners



Section 21 Pages 668-863 Import Clips and Fasteners



Section 23 Pages 866-870 Ball Joint Assemblies

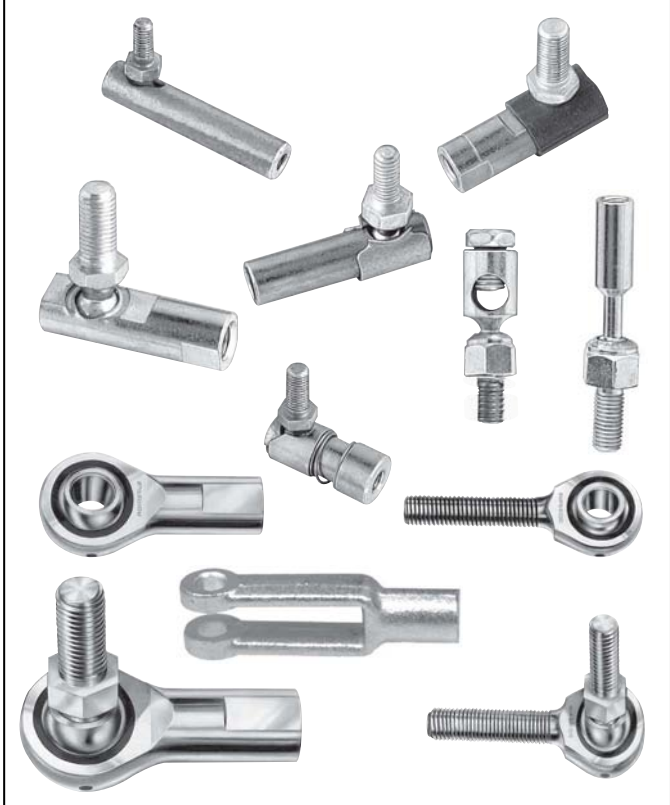

QUICK INDEX

Photos not actual size

Section 24 Pages 871-876

Hose & Tubing Clamps



Section 26 Pages 879-883

Miscellaneous Items



Section 25 Pages 877-878

Body, Seam-n-Joint & Epoxy Sealer and FixitQuik Epoxy Putty



Section 27 Pages 884-890

Tools, Plain White Boxes and Lubrication Items



ALPHABETICAL INDEX

A

Abrasives	365-368
Acorn Nuts	35, 110, 127
Acura Clips & Fasteners	668-678
Adhesive Weatherstrip	426-428
Aerosol Can Caddy	387
Air Conditioning O-Rings	423-424
Air Hose	175
Air Line Couplings & Accs.	175
Alignment Shims	158
Anchor	880
Assortments (Green Pages)	369-420
Audi Clips & Fasteners	849-862
Auto Bulbs	286-293
Auveco Body Sealer	877
Auveco "Fix-Kits"	393-400
AuvecoPak	369-375
Avex® Blind Rivets	343

B

Ball Joint Assemblies	866-870
Barrel Nuts	110, 141
Battery:	
Cable	203
Hold Down Bolts	883
Terminals & Bolts	203-205
Tools	205-206
Belt Weatherstrips	432
Bin Labels	388
Bins	387
Bits:	
Drill	362-363
Torx® (Drivers & Inserts)	26, 94, 887
Blades, Razor	885-886
Blind Rivets	389-339, 341-343
BMW Clips & Fasteners	678-691
Body Bolts:	
Metric	79-89
U.S.	38-41
Body Hardware Master Asst.	376-379
Body Sealer	877
Body Shop Bin Assortments	389
Bolt Retainers:	
Metric	110
U.S.	127
Bolts:	
Battery	205
Battery Hold Down	846
Bed	
Body:	
Metric	79-89
U.S.	38-41
Bumper	36-37
Carriage	29
Grade 5	31
Grade 8	32
Hex Flange Frame	30
License Plate	63-70
Spin Lock	27
Stainless Steel	34
Stove	27

Boxes, Plain White	889
Brackets, Rear View Mirror	440
Brass Fittings	328, 332-337
Brass Grommets	445
Brass Nuts	124
Brushes	
(Acid, Chip, Dope & Scratch)	880
Bulbs, Light	286-293
Bulbs, Miniature	286-287
Bumper Bolts	36-37
Bumpers, Rubber	429-431
Buttons:	
Plug	169-170
Trim	444
Bushings:	
All-Fit Adjustable	881
Door Hinge	623-624, 648
Nylon Spacer (Stand-Offs)	880
Standard Insulating	881

C

Cabinets & Accessories	384-387, 395
Cable:	
Battery	203
Tie Mounts	301
Ties	298-301
Cage Nuts	111, 125, 146
Can Caddy	387
Canvas & Curtain Fasteners	448
Cap Screws:	
Metric	76-78
Socket Head, Metric	78
Stainless Steel	34
U.S. (Gr. 5 & Gr. 8)	31-32
Caps, Rubber & Vinyl Vacuum	171, 433
Carriage Bolts	29
Caulking Gun	888
"Christmas Tree" Retainers	449-523
Chrysler Clips & Fasteners	649-665
Circuit Breakers	206
Circuit Tester	200
Clevis Ends	168, 870
Clevis Pins	167
Clamps:	
Hose	871-875
Tubing	296, 875-876
Clips:	
Acura	668-678
Audi	849-862
BMW	678-691
Chrysler	649-665
Fiat	691
Ford	626-648
General Motors	581-626
Honda	692-717
Hyundai	718-727
Infiniti	728-732
Isuzu	733
Jaguar	734
Kia	734-740
Land Rover	741-743
Lexus	744-759

Clips continued:

Mazda	760-769
Mercedes-Benz	770-780
Mini-Cooper	780-781
Mitsubishi	782-786
Nissan	786-804
Opel	805
Peugeot & Citroen	805-806
Renault & Dacia	807-809
Saab	809
SEAT & Skoda	849-862
Subaru	809-815
Suzuki	816
Tesla	666-667
Toyota	817-849
Volkswagen	849-862
Volvo	862-863
Universal	863
Window Reveal Moulding	435-438
Wire Loom	296-298
Closed-End Connectors & Terminals	178
Compression Battery Terminals	204
Compression Springs	165
Conditioning Disc	366
Connectors:	
Air Line	175
Electrical	177-187, 199, 214-285
Nylon Vacuum	171-174
Trailer	283-285
Copper Washers:	
Metric	118
U.S.	155
Cord, Sponge Rubber	428
Cotter Pins:	
Metric	121
Stainless Steel	34
U.S.	167
Covers & Bases, Screw	20, 446
Crimping Tools (Electrical)	197-198
Curtain Fasteners	448
Cutoff Wheels & Mandrels	364, 890
Cylinder Head Studs:	
Metric	74, 107
U.S.	122

D

Damper Control (Arm)	868
Dampening Pads (Trunk/Vibration/Sound)	879
Disc:	
Mini Grinding	366
Surface Conditioning	366
Strip-Brite	367
Twist-to-lock Holders	366
Door Handle Clips	434-435
Door Hinge:	
Bushings	624-625, 648, 664
Hinge Pins	623-624, 648, 664
Hinge Pin & Bushing Repair Kit	621-622, 664
Door Lock Striker	
Bolt Assemblies	619, 647

ALPHABETICAL INDEX

Double End Threaded Studs:	
Metric	74, 107
U.S.	150
Drain Cocks & Valves	336
Drain Plugs & Gaskets	302-323
Drill Bits	362-363

E

E Type Retaining Rings	119, 160, 163
Electrical Connectors	177-187, 199, 214-285
Electrical Pigtails & Sockets	214-285
Electrical Section (Brown Pages)	177-301
Electrical Tape	206
Electrical Terminals	177-196
Electrical Crimping Tools	197-198
Electronic Fuel Injection Hose	176
Epoxy, Flexible & Rigid	877
Epoxy Putty	878
Expansion Nuts	139
Expansion Plugs:	
Metric	121
U.S.	882
Extension Springs	164
Extruded U-Nuts	116, 148-153

F

Fastener Assortments	390-392
Fasteners, Universal Moulding	864-865
Fender Shims	184
Fiat Clips & Fasteners	691
Fittings:	
Brass	328, 332-337
Grease (Metric)	120, 326
Grease (U.S.)	324-325
"Fix-Kit" Labels	386
"Fix-Kits"	393-400
Flange Bolts	30
Flange Lock Nuts:	
Metric	109
U.S.	30
Flat Nuts	142-143
Flexible Setting Epoxy	877
Foldover Nuts	116, 148-153
Footman Loops	444
Ford Clips & Fasteners	626-648
"FP" Kits	417-420
Frame Bolts	30
Free Spinning Washer Nuts:	
Metric	109
U.S.	127
Fuel Line Clips	643-644
Fuel Line Hose	176
Fuse Tap	180, 212
Fuses, Fuseholders & Accs.	209-213
Fusible Link Wire	202

G

Gaskets, Oil Drain Plug	302-323
Gauges	835
General Motors	
Clips & Fasteners	581-626

Glass Setting Blocks	434
Glass Setting Channel	432
Glass Shop Supplies	434-440
Grease Fittings:	
Metric	120, 326
U.S.	324-325
Grease Guns & Accs.	327
Grinding Disc	366

Grommets:	
Brass	445
Rubber & Vinyl	424, 429-430
Ground Strap, Engine	204

H

Hair Pin Cotter	166-167
Halogen Headlight Bulbs	288, 290-292
Hand Sanding Pads	387
Handles, Window Crank & Door:	
Ford	648
General Motors	625-626
Harness Connectors	214-285
Headlight Adjusting Assy.:	
Chrysler	649
Ford	626-627
General Motors	581-583
Toyota	817

Headlight Adjusting Springs:	
General Motors	583
Headliner Tools	885
Heat Shrink Tubing	207-208
Heater Hose	176
Hex Key Sets	887
Hex Keys:	
Metric	78, 887
Torx*	887
U.S.	887

Hex Lock Nuts (Pal Nuts)	127
Hex Nuts:	
Metric	108
U.S.	124-153

Hinge Bushings (Door)	624-625, 648, 664
Hinge Pins (Door)	623-624, 648, 664
Hog Ring Pliers	887
Hog Rings	444
Hold Down Straps	433
Hole Punch	888
Honda Clips & Fasteners	692-717
Hood Bumpers	429-431
Hood Prop	887
Hook, "S"	433
Horns & Horn Relay	441-442

Hose:	
Air	176
Electronic Fuel Injection	176
Fuel Line	176
Heater	176
Vacuum & Windshield	176
Washer Tubing	176
Hose Clamps	871-875
Hose Clamp Pliers	871, 887
Hyundai Clips & Fasteners	718-727

I

Import Vehicle Section	668-863
Indicator Lamps (Toggle Switch)	270
Infiniti Clips & Fasteners	728-732
Interior Trim Buttons	444
Isuzu Clips & Fasteners	733

J

J Nuts	111-115, 143-146
J Type Cage Nuts	146
Jaguar Clips & Fasteners	734
J.I.S. Cap Screws	77
J.I.S. Flange Bolts	79
J.I.S. Hex Nuts	108

K

Keys:	
Woodruff	170
Kia Clips & Fasteners	734-740
Kits (Green Pages)	369-420

L

Labels, Bin & Lid	388
Land Rover Clips & Fasteners	741-743
Lexus Clips & Fasteners	744-759
License Plate Nuts & Screws	63-72
Light Bulbs	286-293
Locking Hole Plugs	170
Loom, Wire	201
Lubrication Fittings	324-325
Lynch Pins	167

M

Machine Screws:	
Metric	75
Stainless Steel	33
U.S.	27-28
Magnetic Chucks	887
Manifold Studs:	
Metric	107
U.S.	73-74
Maxi-Fuses	235
Mazda Clips & Fasteners	760-769
Mega Fuses	235
Mercedes-Benz	
Clips & Fasteners	770-780
Mechanics Wire	845
Metric Items (Blue Pages)	116-151
Micro Fuses	213
Mini-Cooper Clips & Fasteners	780-781
Mini Fuses	213
Mini Grinding Disc	366
Miniature Bulbs	286-287
Mitsubishi Clips & Fasteners	782-786
Monobolts* & Tools (Rivets)	345
Moulding Clips:	
Acura	668-678
Audi	849-862
BMW	678-691
Chrysler	649-665
Fiat	691
Ford	626-648
General Motors	581-626

ALPHABETICAL INDEX

Honda	692-717
Hyundai	718-727
Infiniti	728-732
Isuzu	733
Jaguar	734
Kia	734-740
Land Rover	741-743
Lexus	744-759
Mazda	760-769
Mercedes-Benz	770-780
Mini-Cooper	780-781
Mitsubishi	782-786
Nissan	786-804
Opel	805
Peugeot & Citroen	805-806
Renault & Dacia	807-809
Saab	809
SEAT & Skoda	849-862
Subaru	809-815
Suzuki	816
Toyota	817-849
Volkswagen	849-862
Volvo	862-863
Universal	863
Window Reveal Moulding	435-438
Moulding Cutting Tool	888
Moulding Tape	879

N

"Nipper" Wire Rope Clips	882
Nissan Clips & Fasteners	786-804

Nuts:

Acorn	35, 110, 127
Brass	124
Cage	111, 125, 146
Collared (Battery)	229
Extruded U	116, 148-153
Flat	142-143
Free Spinning Washer	139, 155
Hex:	
Brass	124
Expansion	139
Flange	140
Flange Lock	80, 139
Frame (Flange Lock)	80
Free Spinning Washer	30, 109
Grade 5 & Grade 8	125
Keys Lock Washer	125
Machine Screw	85, 124
Metric	107
Nylon Insert	35, 107, 124
Prevailing Torque	124
Reversible Lock	124
SAE (Fine)	124-125
Slotted	124
Spin Lock	110, 126
USS (Coarse)	124-125
J Type Nuts	111-115, 143-146
J.I.S.	108
License Plate	68-72
Lock	108, 110, 124-126

Nuts *continued.*

Metric	107-117
Nylon	35, 107, 124
Pal Nuts:	
Metric	109
U.S.	127
Pushnuts, Bolt Retainers:	
Metric	110
U.S.	125
Rubber	140
Self-Threading:	
Metric	107
U.S.	128
Specials	147
Spin Lock:	
Metric	140
U.S.	154
Spring	146-147
Square	125
Stainless Steel	35
Teenuts	132
Thread Cutting:	
Metric	107
U.S.	128
Tubular	110
U-Nuts	111-115, 143-153
Washer Lock Nuts:	
Metric	110
U.S.	126
Wheel	129-130
Wing:	
Metric	110
U.S.	34, 126
Nutserts* & Tool	133-136
Nylon Cable Ties	298-301
Nylon Connectors	171-174
Nylon Insert Lock Nuts:	
Metric	124
U.S.	35, 107

O

O- Ring Assortments	385
O-Rings:	
Air Conditioning	423-424
Metric	322
Rubber (U.S.)	420
O.E.M. Electrical Terminals	188-195
Oil Drain Plugs & Gaskets	302-323
Opel Clips & Fasteners	805

P

PAL Fuses	211
Pal Nuts:	
Metric	109
U.S.	127
Peel-Bak Weatherstrip	391
Peugeot & Citroen	
Clips & Fasteners	805-806
Piano Wire	405
Pigtail Connectors	214-285
Pins:	
Clevis	167

Pins *continued.*

Cotter:	
Hammerlock, U.S.	167
Metric	121
Stainless Steel	34
Hair Pin	166-167
Lynch	167
Retainer	165
Spring/Roll	168
Weld	879
Pipe Fittings	327, 334-335
Plain White Boxes	889
Plastic Plug Buttons	169-170
Plastic Wrap	879
Pliers, Retaining Ring	190, 850
Plug Buttons, Steel,	
Nylon & Plastic	169-170
Plugs:	
Drain	311-323
Expansion:	
Metric	121
U.S.	882
Locking Hole	170
Pipe	327, 334-335
Polyethylene	175
Pop-On Screw Covers & Bases	20, 446
Power Window Lift Motor Gear Kits	440
Power Window Regulator Gears	440
Prep Pen	886
Prevailing Torque Locknuts	124
Primary Wire	201-202
Push-On Retainers:	
Metric	110
U.S.	127
Pushnut Bolt Retainers:	
Metric	110
U.S.	126
Pushnut Fasteners	110, 126-127, 882
Push-Pull Controls	882
Push-Type Retainers	524-569
Specification Chart	570-580

Q

Quik-Select Assortments	407-415
Quik-Select Boxes	407
Quik-Select II Assortments	401-406
Quik-Select II Boxes	401

R

Racks:	
Wire Spool	386
Razor Blades & Scraper	885-886
Rear View Mirror Brackets	440
Renault & Dacia	
Clips & Fasteners	807-809
Retainers:	
Bolt:	
Metric	141
U.S.	154
Pins	191
Push-On:	
Metric	141

ALPHABETICAL INDEX

U.S.	154
Push-Type	524-569
Push-Type	
Specification Chart	570-580
"Xmas Tree"	449-508
"Xmas Tree"	
Specification Chart	509-523
Retaining Rings & Pliers	159-164, 887
Rivet Guns & Nosepieces	340
Rivet Washers	340
Rivets:	
Avex®	343
Blind	389-339, 341-344
Closed-End	346
Klamp-tite	344
Large Secondary Head	344
Monobolt®	345
Multi-Grip	342
Nylon	341-342
Pan'l (Pop®)	389-339, 342
"Peel-Type"	346-347
Self-Piercing	360-361
Solid Aluminum	389
Specialty	348-359
Stavex® Large Flange	343
Tacking	344
Ultragrip	346
Rod End Ball Joints	866-867
Roll/Spring Pins	168
Routing Clips	296-298
Rubber:	
Bumpers	429-431
Caps	171, 433
Connectors	201
Grommets	424, 429-430
Hold Down Straps	433
Nuts	140
O-Rings	322, 420, 423-424
Tape	206
Weatherstrip	426-428, 432

S

"S" Hooks	433
Saab Clips & Fasteners	809
SEAT & Skoda	
Clips & Fasteners	849-862
Screw Anchors	880
Screw Covers & Bases	20, 446
Screws:	
Cap:	
Grade 5	31
Grade 8	32
Metric	76-78
Stainless Steel	34
Drill Point	23
Hex:	
Regular	24
Sems®	22, 25, 38-41
Washer Head:	
Regular	24
Slotted	22-23
Teks®	24

Type F	23
License Plate	63-70
Machine:	
Metric	75
U.S.	27-28, 33
Phillips:	
Flat Head Tapping	20
Flat Head Wood	26
Flat Top Washer Head Tapping	22
Oval Head Machine	27, 75
Oval Head Sems® Tapping	22
Oval Head Sems® Tek®	22
Oval Head Tapping	19, 33
Oval Head Tek® Tapping	19, 22
Pan Head Machine	28, 75
Pan Head Sems® Tapping	22
Pan Head Tapping	21, 33
Pan Head Tek®	24
Round Head Machine	28, 33
Self-Piercing	23
Set	29, 79
Slotted:	
Fillister Head Metric	75
Flat Head Machine	75
Hex Head Self-Piercing	23
Hex Washer Head Tapping	25
Oval Head Tapping	19
Pan Head Machine	75
Pan Head Tapping	21
Pan Head Type F	22
Round Head Machine	28, 33
Socket Head Cap (Metric)	78
Socket Head Set:	
Metric	79
U.S.	29
Specialty	42-62, 90-106
Stainless Steel	33-34
Tapping	19-26, 33, 90-106
Teks®	22, 24, 26, 42-62, 90-106
Torx®:	
Drive Floor	26
Pan Head Tapping	20
Metric	20
U.S.	26
Trim	19-25
Wood, Flat Head	26
Sealer, Automotive	877
Self-Threading Nuts:	
Metric	107
U.S.	128
Seam-N-Joint Sealer	877
Set Screws	29, 79
Sheet Metal Plugs	169
Shims	184
Snaps	158
Sockets, Electrical	214-285
Solderless Terminals	177-187
Sound Dampening Pads	879
Speed Nuts®	111-118, 141-153
Split Flexible Tubing	201
Sponge Rubber	877
Weatherstrip	426-428, 432

Spring Nuts	146-147
Spring Pins	168
Springs:	
Extension & Compression	164
Truck Seat	447
Stainless Steel Fasteners	33-35
Stainless Steel Grease Fittings	324-325
Stand-Offs, Nylon	880
Stove Bolts	27
Straight Keys	170
Strain Relief Cable Connector	297
Strap, Engine Ground	204
Straps, Rubber Tie Down	433
Strip-Brite Disc	367
Studs, Manifold:	
Metric	107
U.S.	73-74
Subaru Clips & Fasteners	809-815
Surface Conditioning Disc	366
Suzuki Clips & Fasteners	816
Switches:	
Horn Button	294
Push-Pull	294
Toggle	294-296

T

Tape:	
Electrical	206
Moulding	879
Rubber	206
Tapping Screws	19-26, 33, 90-106
Teenuts®	132
Test Clips	202
Terminals:	
Battery	203-205
Electrical	177-196
Tesla Clips & Fasteners	666-667
Thread Cutting Nuts:	
Metric	107
U.S.	155
Thread Cutting Screws	73
Threaded Inserts:	
Nutserts®	133-136
Thread Repair	137-138
Throttle Rod Clips	165
Ties, Cable (& Mounts)	298-301
Tire Valves	425
Toggle Bolts	880
Toggle Switches	294-296
Tools:	
Battery Tools	205-206
Caulking Gun	888
Circuit Tester	200
Cut-Off Wheel & Mandrels	364, 890
Door Handle Clip Tool	434-435
Electrical Connector Separator	222
Electrical Crimping Tools	197-198
Expansion Nut Installation Tool	136
Gauges	835
Glass Shop	884-886
Grease Guns	327
Headliner Tools	885

ALPHABETICAL INDEX

Hex Key Sets	887	Vinyl Caps	171, 43	Window Regulator Drive Block	440
Hog Ring Pliers	887	Vinyl Grommets	424, 429-430	Window Reveal Moulding Clips	435-438
Hole Punch	888	Vinyl Tubing	176, 881	Windshield Moulding Clip Tool	884
Hood Prop	887	Volkswagen Clips & Fasteners	849-862	Windshield Washer &	
Hose Clamp Pliers	871, 887	Volvo Clips & Fasteners	862-863	Vacuum Tubing	176
Hose Cutter	888			Wire:	
Magnetic Chucks	887	W		Bending Tool	
Moulding Cutting Tool	888	Washer Cap Type Pushnut Fasteners		(Truck Seat Spring)	447, 888
Nutsert® Installation Tool	136	882		Fusible Link Wire	202
Pick (O-Ring & Seal)	886	Washer Lock Nuts:		Loom	201
Prep Pen	886	Metric	140	Mechanics Wire	845
Razor Blade Scraper	885-886	U.S.	126	Piano Wire	405
Retaining Ring Pliers	164, 887	Washer Type Self-Threading Nuts:		Primary Wire	201-202
Revolving Punch	888	Metric	110	Rope Clips (Nipper)	882
Rivet Guns & Nosepieces	340	U.S.	127	Wire Nuts	199
Seat Spring Wire Bender	447	Washers:		Wire Spool Racks	386
Terminal Extractor Picks	197	Belleville	155	Woodruff Keys	170
Test Clips	202	Bowed Spring	155		
Torx® Bits & Drivers	26, 94, 887	Copper:		X	
Trim Pad Removal Tool	885	Metric	118	X- Washers	157
		U.S.	155	"Xmas Tree" Retainers	449-523
Tools continued:		Countersunk	154, 445		
Truck Seat Spring	447	Countersunk Lock	156	Y	
Bending Tool	447, 888	Fender	156	Yoke Ends	168, 870
Windshield Moulding Tools	884	Flanged	154, 445		
Windshield Wiper Arm Remover	885	Flat:			
Torx® Bits & Drivers	26, 94, 887	Metric	117		
Toyota Clips & Fasteners	817-849	U.S.	35, 154-157		
Trailer Connectors	284	Flush	154, 445		
Trim Clips	443-444	High Strength, U.S.S. & S.A.E.	155		
Trimming Sundries & Fasteners	443-580	Internal & External Combo Lock			
Truck Seat Spring Wire Bender	447, 888		156-157		
Truck Seat Springs	447	Lock	118, 155-157		
Truck Wheel Hardware	129-131	Metric	118		
Tubeless Tire Valves	425	Nylon Finishing	154, 446		
Tubing:		Nylon Flat	157		
Clamps	296, 875-876	Rivet	340		
Clear Vinyl (PVC)	176, 881	S.A.E.	154		
Connectors:		Split Lock, Regular & High Alloy	155		
Brass	292	Spring Wave, Metric	118		
Nylon	171-174	Stainless Steel	35		
Heat Shrink	207-208	Tooth (Internal, External			
Vacuum & Windshield Washer	176	& Countersunk)	156-157		
Tubular Nuts	110	Vibration Proof	156		
Twist-to-lock Holders	366	Wave, Metric	118		
		Wrought (USS)	154		
U		X	157		
U-Nuts	111-115, 143-153	Weather-Seal Wrap	879		
Universal Moulding Clips	863	Weatherpack Terminals	189-190		
Universal Springs	165	Weatherstrip	426-428, 432		
		Weatherstrip for Glass	428, 432		
V		Weld Pins	879		
Vacuum:		Wheel Studs & Nuts	129-131		
Rubber & Vinyl Caps	171, 433	Windlace Cord	428		
Tubing	176	Window Channels	432		
Tubing Connectors	171-174	Window Crank Handle Clips	434-435		
Vacuum & Windshield Washer Tubing	176	Window Crank Handles:			
Valves, Tubeless Tire	425	Ford	648		
Vent Window Seals	432	General Motors	625-626		
Vibration Dampening Pads	879	Window Guides	437-438		
		Window Lift Motor Gear Kit	440		

FASTENER TERMINOLOGY

Bolt: Externally threaded, headed fastener. Difference between a bolt and a screw: a bolt is generally used through a hole with a mating nut. A screw is used in a threaded hole without a nut.

Class of Thread: A system to distinguish thread tolerance differences. Classes 1A, 2A, and 3A apply to external threads. 1B, 2B, and 3B apply to internal threads. Classes 2 and 3 apply to both external and internal threads.

Crest: Outermost tip of male thread from the fastener cylinder, or innermost tip of female thread.

Driving Recess: Recess in the fastener head designed to accept a driving tool.

External Thread: Male thread. Thread outside of the cylinder surface.

Internal Thread: Female thread. Thread on the inside surface of a cylinder or cone.

Left-Hand Thread: Thread that winds counter-clockwise from the starting end of a fastener.

Right-Hand Thread: Thread that winds clockwise from the starting end of a fastener (viewed from starting end).

Major Diameter: Largest diameter of a screw thread on a straight thread. It is the diameter of an imaginary cylinder which would pass through the crest of an external thread or the root of an internal thread.

Minor Diameter: On a straight thread it is the diameter of an imaginary cylinder bounding the root of an external thread or the crest of an internal thread.

Nominal Diameter: Basic diameter that determines the size and dimensional limits of fasteners.

Pitch: Distance from a point of a screw thread to a corresponding point on the next thread measured parallel to the axis.

Screw: Headed fastener which is externally threaded.

Sems[®]: Pre-assembled screw and washer assemblies. Washers are placed on screws before roll threading. Threads of larger diameter than the washer hole thus prevent the washer from slipping off the screw.

Stud: Threaded rod at both ends or for entire length.

Tapping Screw: Hardened thread screw made to cut or form its own mating thread in an untapped hole.













Teks[®]: Screw which drills its own hole and then threads in.

Thread Pitch: Distance from the crest of one thread to the crest of another.









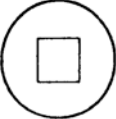

PLATINGS AND FINISHES

Finish	Color	Anti-Corrosion Properties	Characteristics and Uses	
Black Oxide	Black	Good (Interior Only): 8 Hour Salt Spray	Most Metals	Decorative finish. Used only on interior applications.
Black Zinc	Black	Excellent: 48 Hour Salt Spray	All Metals	Rich and lustrous. With or without lacquering.
Cadmium	Bright Silver-Gray Dull or Burnished	Very Good: 24 Hour Salt Spray	Most Metals	Non-porous metallic plating. Rich appearance, good rust resistance, low cost, good electrical conductivity. Bright silver- gray dull gray or black electroplated finish.
Chromium (Chrome)	Bright Blue-White	Excellent: 24 Hour Salt Spray	All Metals	Used when a beautiful finish is desired. Bright blue-white lustrous appearance. Electroplated.
Dichromate Dip	Rainbow	Excellent	All Metals	A yellow, brown, green or iridescent colored coating. Increases rust resistance. Add to Zinc or Cadmium plating.
E-Coat	Black	Excellent: 168 Hour Salt Spray	All Metals	Added protection containing corrosion inhibitors. Excellent for exterior applications.
Iridite	Green, Blue, Olive drab, Red, Bronze or Black	Excellent	All Metals	Coloring dip which adds rust resistance. Usually applied on Zinc or Cadmium.
JS-500	Chrome like luster	Excellent: 500 Hour Salt Spray	All Metals	Outstanding corrosion resistant finish that provides economical corrosion protection without adversely affecting dimensions.
Mechanical Zinc	Gray	Very Good: 48 Hour Salt Spray	All Metals	A chemical process of rust-proofing steel.
Nickel	Silver	Very Good: 24 Hour Salt Spray	All Metals	A hard, stable, dull white or bright burnished finish. Used for appliances and hardware.
Parkerized	Black	Excellent: 72 Hour Salt Spray	Ferrous Metals	Added protection when oiled with non-drying petroleum oil containing corrosion inhibitors. Good lubricity.
Phosphating	Dull, Gray, Black, or Blue	Excellent: 24 Hour Salt Spray	Ferrous Metals	A chemical process of rust-proofing steel.
Passivating		Excellent	Stainless Steels	For stainless steels. A nitric acid dip to remove foreign material and brighten finish.
Zinc Electroalvanized	Gray	Very Good: 24 Hour Salt Spray	All Metals	Good rust resistance, appearance & low cost.
Zinc Electroplated	Blue to Blue-White-Gray	Very Good: 24 Hour Salt Spray	All Metals	Commonly used finish.



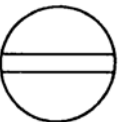











HEAD STYLES

				
Binding: undercut unless otherwise specified. Not rec for phillips recess	Fillister: deep slot used for counter bored holes	Flat Fillister: same as standard fillister without oval top	Flat 82+: used where flush surface is desired	Flat 100+: larger head than 82° used for thin metal soft plastic
				
Flat Trim: same as 82+ except diameter and countersink depth reduced	Flat Undercut: standard 82+ with lower 1/3 countersink removed for short screws	Hexagon: manufactured as trim hex or indented hex	Hex Washer: same as hexagon with washer section	Oval: same as flat head with rounded surface for appearance
				
Oval Undercut: similar to flat undercut with rounded surface	Oval Trim: same as oval, smaller diameter and countersink	Pan: recommended to replace round, truss binder	Round: general purpose (see pan head)	Round Countersunk: bolts only. Similar to flat head with no driving recess
				
Round Washer: same as round head with integral washer for bearing surface.	Square: bolts only. Large bearing surface for wrench tightening	Square Countersunk: for use on plow bolts	Square (Set Screw): recommended for high torque assembly	Truss: similar to round head with larger diameter (see pan head)

HEAD STYLES

Cross-Recessed (Phillips) 	Square Socket 
Pozi Drive 	Slot & Square Socket 
Frearson 	Indent Hex Washer 
Phillips & Slot 	Indent Slotted Hex Washer 
Slot 	Phillips Pyramid 
Cross-Slot 	Clutch 
Torx® 	

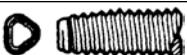
POINT STYLES

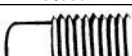
Type AB 
Type I7 
Type BP 
Type A 
Type B 
Type BT(25) 
Type C 
Type T(23) 
Type D(1) 
Type F 
Type G 
Type BF 
Type U 
Type TT 
Type CA 
Dog Point 

TAPPING SCREWS

Diameter, Head Size & Length Identification

Oval Head Tapping Screws

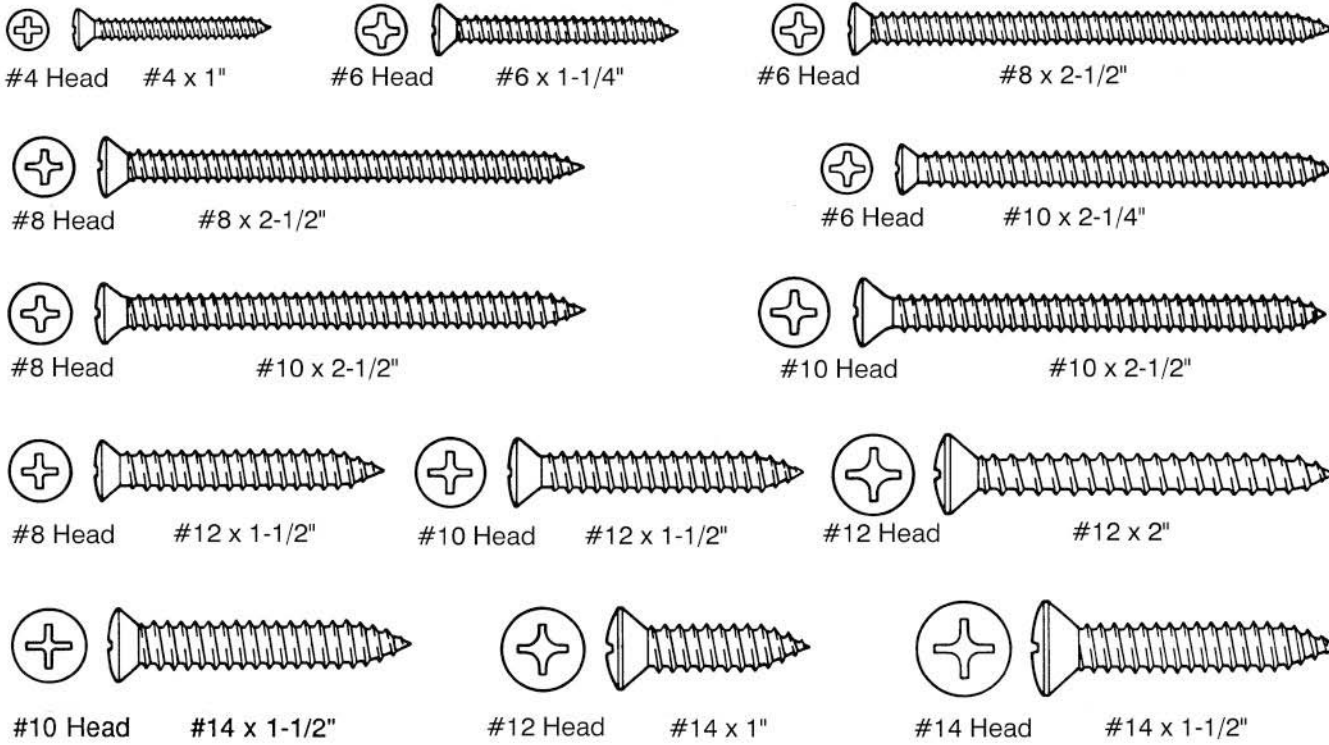

Pan Head Tapping Screws

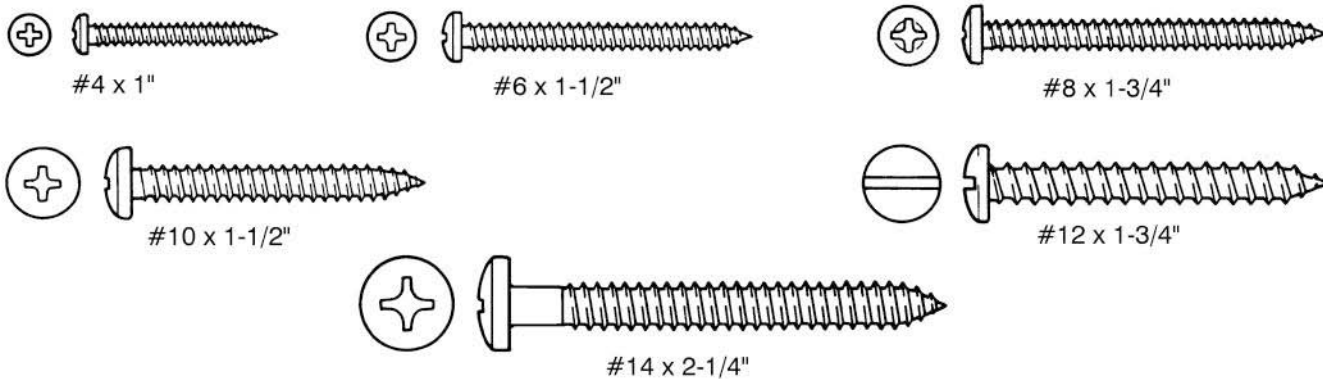

How to Measure Tapping Screws

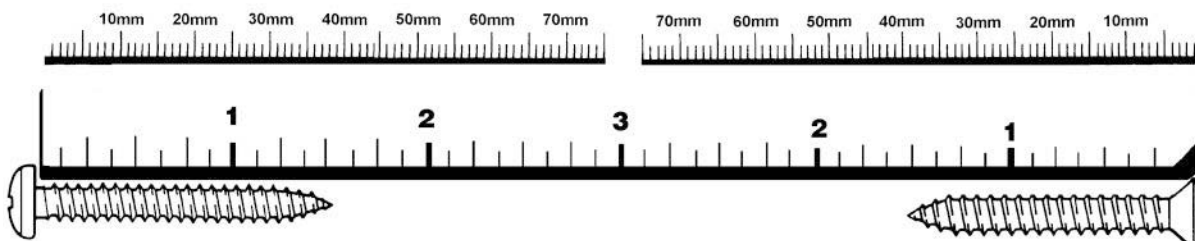

Place Pan Head, Hex Head or Hex Washer Head Screws at this end to measure the length (under the head)

Place Oval Head or Flat Head Screws in the blackened area to measure the length

METRIC ITEM CONVERSION CHART

Inch Fractions and Decimals to Metric Equivalents

Inches			Inches			Inches		
Fractions	Decimals	mm	Fractions	Decimals	mm	Fractions	Decimals	mm
----	.0004	.01	31/64	.48437	12.303	----	1.1417	29
----	.004	.10	----	.492	12.5	1-5/32	1.156	29.369
----	.01	.25	1/2	.500	12.700	----	1.1811	30
1/64	.0156	.397	----	.5118	13	1-3/16	1.1875	30.163
----	.0197	.50	33/64	.5156	13.097	1-7/32	1.219	30.956
----	.0295	.75	17/32	.53125	13.494	----	1.2205	31
1/32	.03125	.794	35/64	.54687	13.891	1-1/4	1.250	31.750
----	.0394	1	----	.5512	14	----	1.2598	32
3/64	.0469	1.191	9/16	.5625	14.288	1-9/32	1.281	32.544
----	.059	1.5	----	.571	14.5	----	1.2992	33
1/16	.0625	1.588	37/64	.57812	14.684	1-5/16	1.312	33.338
5/64	.0781	1.984	----	.5906	15	----	1.3386	34
----	.0787	2	19/32	.59375	15.081	1-11/32	1.344	34.131
3/32	.094	2.381	39/64	.60937	15.478	1-3/8	1.375	34.925
----	.0984	2.5	5/8	.6250	15.875	----	1.3779	35
7/64	.1093	2.776	----	.6299	16	1-13/32	1.406	35.719
----	.1181	3	41/64	.6406	16.272	----	1.4173	36
1/8	.1250	3.175	----	.6496	16.5	1-7/16	1.438	36.513
----	.1378	3.5	21/32	.65625	16.669	----	1.4567	37
9/64	.1406	3.572	----	.6693	17	1-15/32	1.469	37.306
5/32	.15625	3.969	43/64	.67187	17.066	----	1.4961	38
----	.1575	4	11/16	.6875	17.463	1-1/2	1.500	38.100
11/64	.17187	4.366	45/64	.7031	17.859	1-17/32	1.531	38.894
----	.177	4.5	----	.7087	18	----	1.5354	39
3/16	.1875	4.763	23/32	.71875	18.256	1-9/16	1.562	39.688
----	.1969	5	----	.7283	18.5	----	1.5748	40
13/64	.2031	5.159	47/64	.73437	18.653	1-19/32	1.594	40.481
----	.2165	5.5	----	.7480	19	----	1.6142	41
7/32	.21875	5.556	3/4	.7500	19.050	1-5/8	1.625	41.275
15/64	.23437	5.953	49/64	.7656	19.447	----	1.6535	42
----	.2362	6	25/32	.78125	19.844	1-21/32	1.6562	42.069
1/4	.2500	6.350	----	.7874	20	1-11/16	1.6875	42.863
----	.2559	6.5	51/64	.79687	20.241	----	1.6929	43
17/64	.2656	6.747	13/16	.8125	20.638	1-21/32	1.719	43.656
----	.2756	7	----	.8268	21	----	1.7323	44
9/32	.28125	7.144	53/64	.8281	21.034	1-3/4	1.750	44.450
----	.2953	7.5	27/32	.84375	21.431	----	1.7717	45
19/64	.29687	7.541	55/64	.85937	21.828	1-25/32	1.781	45.244
5/16	.3125	7.938	----	.8662	22	----	1.8110	46
----	.3150	8	7/8	.8750	22.225	1-13/16	1.8125	46.038
21/64	.3281	8.334	57/64	.8906	22.622	1-27/32	1.844	46.831
----	.335	8.5	----	.9055	23	----	1.8504	47
11/32	.34375	8.731	29/32	.90625	23.019	1-7/8	1.875	47.625
----	.3543	9	59/64	.92187	23.416	----	1.8898	48
23/64	.35937	9.128	15/16	.9375	23.813	1-29/32	1.9062	48.419
----	.374	9.5	----	.9449	24	----	1.9291	49
3/8	.3750	9.525	61/64	.9531	24.209	1-15/16	1.9375	49.213
25/64	.3906	9.922	31/32	.96875	24.606	----	1.9685	50
----	.3937	10	----	.9843	25	1-31/32	1.969	50.006
13/32	.4062	10.319	1	1.000	25.4	2	2.000	50.800
----	.413	10.5	----	1.0236	26	----	2.0079	51
27/64	.42187	10.716	1-1/32	1.0312	26.194	----	2.0472	52
----	.4331	11	1-1/16	1.062	26.988	2-1/16	2.062	52.388
7/16	.4375	11.113	----	1.063	27	----	2.0866	53
29/64	.4531	11.509	1-3/32	1.094	27.781	2-1/8	2.125	53.975
15/32	.46875	11.906	----	1.1024	28	----	2.126	54
----	.4724	12	1-1/8	1.125	28.575	----	2.165	55

METRIC ITEM CONVERSION CHART

Inch Fractions and Decimals to Metric Equivalents

Inches			Inches			Inches		
Fractions	Decimals	mm	Fractions	Decimals	mm	Fractions	Decimals	mm
2-3/16	2.1875	55.563	----	3.1496	80	4-1/4	4.250	107.950
----	2.2047	56	3-3/16	3.1875	80.963	4-5/16	4.312	109.538
----	2.244	57	----	3.1890	81	----	4.3307	110
2-1/4	2.250	57.150	----	3.2283	82	4-3/8	4.375	111.125
----	2.2835	58	3-1/4	3.250	82.550	4-7/16	4.438	112.713
2/5-16	2.312	58.738	----	3.2677	83	4-1/2	4.500	114.300
----	2.3228	59	----	3.3071	84	----	4.5275	115
----	2.3622	60	3-5/16	3.312	84.1377	4-9/16	4.562	115.888
2-3/8	2.375	60.325	----	3.3464	85	4-5/8	4.625	117.475
----	2.4016	61	3-3/8	3.375	85.725	----	4.7244	120
2-7/16	2.438	61.913	----	3.3858	86	4-3/4	4.750	120.650
----	2.4409	62	----	3.4252	87	4-7/8	4.875	123.825
----	2.4803	63	3-7/16	3.438	87.313	----	4.9212	125
2-1/2	2.500	63.500	----	3.4646	88	5	5.000	127
----	2.5197	64	3-1/2	3.500	88.900	----	5.1181	130
----	2.559	65	----	3.5039	89	5-1/4	5.250	133.350
2-9/16	2.562	65.088	----	3.5433	90	5-1/2	5.500	139.700
----	2.5984	66	3-9/16	3.562	90.4877	----	5.5118	140
2-5/8	2.625	66.675	----	3.5827	91	5-3/4	5.750	146.050
----	2.638	67	----	3.622	92	----	5.9055	150
----	2.6772	68	3-5/8	3.625	92.075	6	6.00	152.400
2-11/16	2.6875	68.263	----	3.6614	93	6-1/4	6.250	158.750
----	2.7165	69	3-11/16	3.6875	93.663	----	6.2992	160
2-3/4	2.750	69.850	----	3.7008	94	6-1/2	6.500	165.100
----	2.7559	70	----	3.7401	95	----	6.6929	170
----	2.7953	71	3-3/4	3.750	95.250	6-3/4	6.750	171.450
2-13/16	2.8125	71.438	----	3.7795	96	7	7.000	177.800
----	2.8346	72	3-13/16	3.8125	96.838	----	7.0866	180
----	2.8740	73	----	3.8189	97	----	7.4803	190
2-7/8	2.875	73.025	----	3.8583	98	7-1/2	7.500	190.500
----	2.9134	74	3-7/8	3.875	98.425	----	7.8740	200
2-15/16	2.9375	74.613	----	3.8976	99	8	8.000	203.200
----	2.9527	75	----	3.9370	100	----	8.2677	210
----	2.9921	76	3-15/16	3.9375	100.013	8-1/2	8.500	215.900
3	3.000	76.200	----	3.9764	101	----	8.6614	220
----	3.0315	77	4	4.000	101.600	9	9.000	228.600
3-1/16	3.062	77.788	4-1/16	4.062	103.188	----	9.0551	230
----	3.0709	78	4-1/8	4.125	104.775	----	9.4488	240
----	3.1102	79	----	4.1338	105	9-1/2	9.500	241.300
3-1/8	3.125	79.375	4-3/16	4.1875	106.363	----	9.8425	250

U.S. STANDARD GAUGE CHART

Gauge	Decimal Size	Gauge	Decimal Size	Gauge	Decimal Size	Gauge	Decimal Size
7	.188"	14	.078"	21	.034"	28	.016"
8	.172"	15	.070"	22	.031"	29	.014"
9	.156"	16	.063"	23	.028"	30	.013"
10	.141"	17	.056"	24	.025"	31	.011"
11	.125"	18	.050"	25	.022"		
12	.109"	19	.044"	26	.019"		
13	.094"	20	.038"	27	.017"		

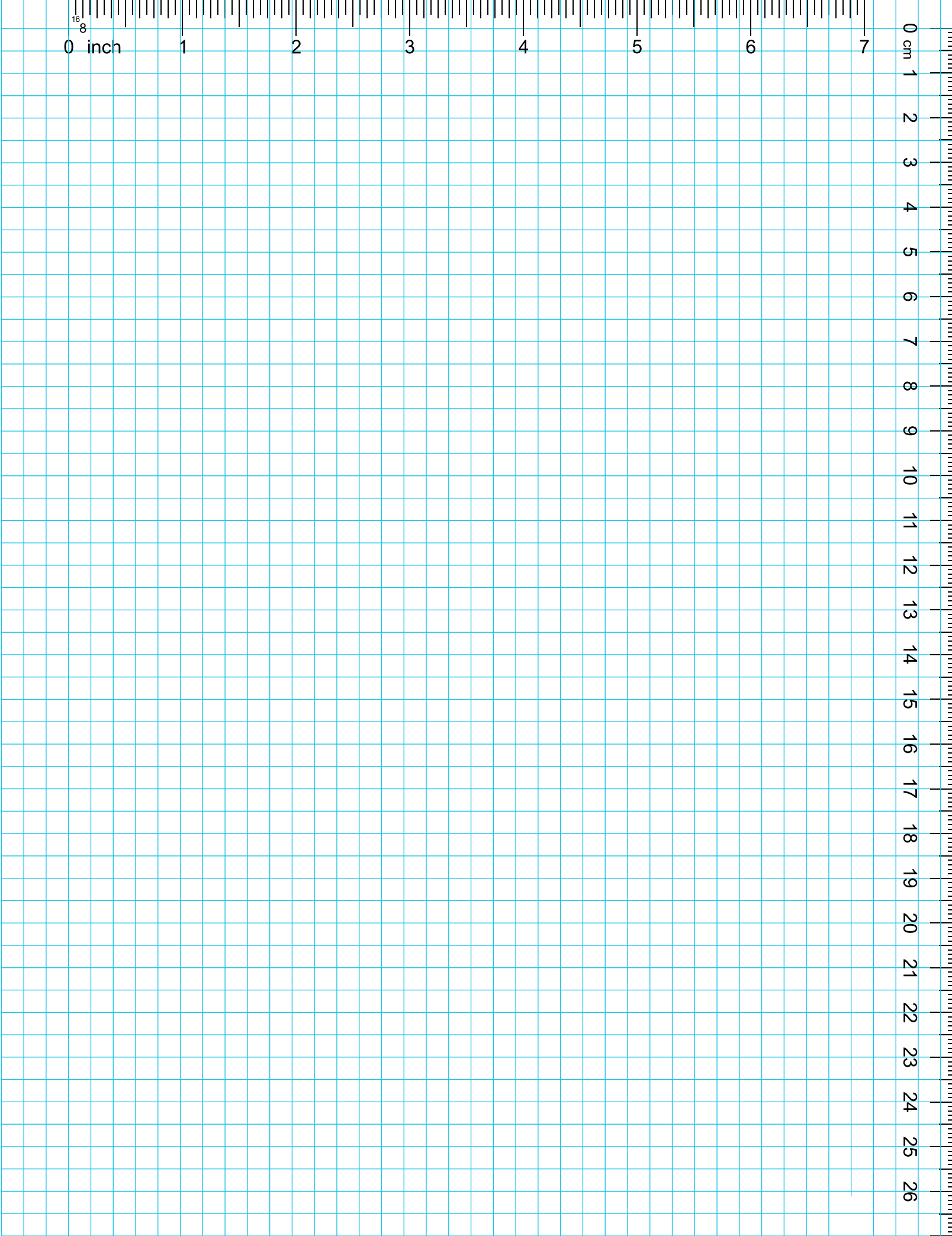
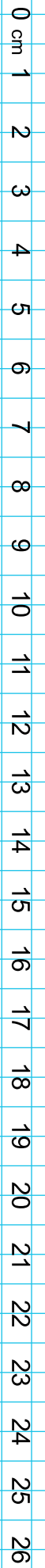
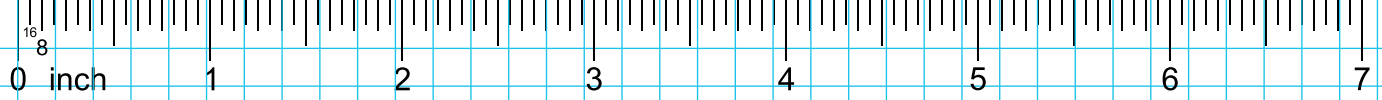

TAPPING SCREWS

Listed According to Size



Phillips Oval Head Tapping Screws



Size	Zinc Part No.	Chrome Part No.	Bk. Oxide Part No.	Unit Pkg.
4 x 3/8"	3062		12893	100
4 x 1/2"	3063	3068	12894	100
4 x 3/4"		3069	12896	100
4 x 1"			12897	100
6 x 3/8" 4 Hd		2802		100
6 x 1/2"	2571	2698	12795	100
6 x 5/8"	2699	1793	23628	100
6 x 3/4"	2700	1794	12796	100
6 x 7/8"	2572			100
6 x 1"	2702	1796	12797	100
6 x 1-1/4"		1797	12798	100
8 x 3/8" 6 Hd		2024		100
8 x 3/8"	3484			100
8 x 1/2" 6 Hd	2706	2027	10162	100
8 x 1/2"	2358	2707	10163	100
8 x 5/8" 6 Hd		1421		100
8 x 5/8"		2709		100
8 x 3/4" 6 Hd	1798	1799	10164	100
8 x 3/4"	2359	2710	10165	100
8 x 3/4" 10 Hd		20373	23806	100
8 x 7/8" 6 Hd	1800	2711		100
8 x 7/8"	2575	2712		100
8 x 1" 6 Hd	1801	1483	10166	100
8 x 1"	2360	2713	10167	100
8 x 1-1/8" 6 Hd		180		100
8 x 1-1/4" 6 Hd	1803	1423	10168	100
8 x 1-1/4"	2361	2716	10169	100
8 x 1-1/2" 6 Hd	2717	1932	10170	100
8 x 1-1/2" 6 Hd		1424		100
(Special Long Shank)				
8 x 1-1/2"	2362	2718	10171	100
8 x 1-3/4" 6 Hd		1933		100
8 x 2" 6 Hd	2632	24033		100

Size	Zinc Part No.	Chrome Part No.	Bk. Oxide Part No.	Unit Pkg.
8 x 2"	2633			100
8 x 2-1/2"	3205			100
10 x 1/2" 6 Hd	2720			100
10 x 1/2" 8 Hd		2657		100
10 x 1/2"	2579	2722	11084	100
10 x 5/8" 8 Hd		2724		100
10 x 5/8"	2580			100
10 x 3/4" 8 Hd	2727	1717	11087	100
10 x 3/4"	2581	2728	11086	100
10 x 1" 6 Hd	2729	1804		100
10 x 1" 8 Hd	2578	2730	11089	100
10 x 1"	2582	2731	11088	100
10 x 1-1/4" 8 Hd	2661	2734		100
10 x 1-1/4"	2583		11090	100
10 x 1-1/2" 8 Hd		20374		100
10 x 1-1/2"	2585		11092	100
10 x 2" 8 Hd			23629	100
10 x 2"	2666			100
12 x 3/4"	8050			100
12 x 1"	8056			100
12 x 2"	8068			100
14 x 1"	8083			100

WARNING: ALL CHROME PARTS IN CHART Reproductive Harm & Cancer - www.P65Warnings.ca.gov



Phillips Oval Head Tek[®] Tapping Screws Phosphate

Auveco Part No.	Size	Unit Pkg.
16736	8 x 1" 6 Hd	50



Slotted Oval Head Tapping Screws Bright Zinc Chromate

Auveco Part No.	Size	Unit Pkg.
1149	8 x 3/4"	100

WARNING: Reproductive Harm & Cancer
www.P65Warnings.ca.gov

TAPPING SCREWS

Listed According to Size



Pop On Polypropylene Screw Covers & Bases

They're simple to use:

1. Place washer over pilot or starting hole for screw, nail or rivet.
2. Install fastener.
3. Place Snap Cap over washer at slight angle.
4. Simply push Snap Cap down firmly.

Covers



Auveco Part No.	Screw Size	Color	O.D.	Unit Pkg.
13831	#4	Black	1/2"	50
13833	#6	Black	1/2"	50
13835	#8	Black	5/8"	50
13836	#8	White	5/8"	50
13837	#10	Black	5/8"	50
13838	#10	White	5/8"	50

Bases



Auveco Part No.	Size	Use with Cover	Unit Pkg.
13840	#6	13833 & 13834	50
13841	#8	13835 & 13836	50
13842	#10	13837 & 13838	50

Phillips Flat Head Tapping Screws

Size	Zinc Part No.	Unit Pkg.	Bk. Oxide Part No.	Unit Pkg.
4 x 1/4"	5646	100		
4 x 3/8"	5647	100	12899	100
4 x 1/2"	5648	100	12900	100
4 x 5/8"	5649	100		
6 x 1/2"	4 Hd 5651	100		
6 x 1/2"	1946	100	12801	100
6 x 5/8"	5653	100		
6 x 3/4"			12802	100
6 x 1"			12803	100
8 x 3/8"	6 Hd 5654	100		
8 x 7/16"	6 Hd 1479	100		
8 x 1/2"	6 Hd 2804	100	10173	100
8 x 1/2"	5655	100	10172	100
8 x 3/4"	6 Hd 1712	100	10174	100
8 x 3/4"	2807	100	10175	100
8 x 1"	6 Hd 5660	100	10176	100
8 x 1"	5661	100	10177	100
8 x 1-1/4"			10179	100
8 x 1-1/2"			12806	50
10 x 1/2"			12807	100
10 x 3/4"	2810	100	12809	100
10 x 1"	5672	100	12811	50



Slotted Pan Head Tapping Screws

Bright Zinc Chromate

Auveco Part No.	Size	Unit Pkg.
3022	4 x 1/2"	100
1263	6 x 3/8"	100
145	6 x 1"	100
1456	8 x 3/8"	100
1146	8 x 1/2"	100
1092	8 x 5/8"	100
1457	8 x 1"	100
3028	8 x 1-1/2"	100
1458	10 x 1/2"	100
1787	10 x 5/8"	100
1459	10 x 1"	100
1344	12 x 3/4"	100
1381	14 x 3/4"	100
1382	14 x 1"	100

WARNING: ALL ITEMS IN CHART Reproductive Harm & Cancer - www.P65Warnings.ca.gov

TAPPING SCREWS

Listed According to Size



Phillips Pan Head Tapping Screws

Size	Zinc Part No.	Unit Pkg.	Bk. Oxide Part No.	Unit Pkg.
4 x 1/4"	3071	100	12902	100
4 x 3/8"	3072	100	12903	100
4 x 1/2"	3073	100	12904	100
4 x 3/4"	3074	100	12905	100
6 x 1/4"	1935	100		
6 x 3/8"	1936	100	16889	100
6 x 1/2"	1937	100	11917	100
6 x 5/8"	5621	100		
6 x 3/4"	2364	100	11918	100
6 x 1"	3076	100	11919	100
6 x 1-1/4"	3077	100	11920	100
6 x 1-1/2"	3078	100		
8 x 3/8"	1939	100		
8 x 1/2"	1940	100	10180	100
8 x 5/8"	5625	100		
8 x 3/4"	2365	100	10181	100
8 x 7/8"	5626	100		
8 x 1"	3079	100	10182	100
8 x 1-1/4"	3080	100	10183	100
8 x 1-1/2"	3081	100	12799	50
10 x 3/8"	1942	100		
10 x 1/2"	1943	100	11921	100
10 x 5/8"	2808	100	24137	100
10 x 3/4"	2366	100	11922	100
10 x 7/8"	5629	100		
10 x 1"	3082	100	11923	50
10 x 1-1/4"	3083	100	11924	50
10 x 1-1/2"	3084	100	12800	50
12 x 1/2"	3085	100		
12 x 5/8"	5630	100		
12 x 3/4"	2367	100		
12 x 1"	3086	100		
12 x 1-1/4"	3087	100		
12 x 1-1/2"	3088	100		
14 x 1/2"	3089	100		
14 x 5/8"	5632	100		
14 x 3/4"	3090	100	24134	100
14 x 7/8"	5633	100		
14 x 1"	3091	100	24135	100
14 x 1-1/4"	3092	100		
14 x 1-1/2"	3093	100		
14 x 1-3/4"	3211	100		
14 x 2"	5634	100		



Teks® Self-Drilling

Size	Black Painted Head Part No.	Tan Painted Head Part No.	White Painted Head Part No.	Unit Pkg.
6 x 1/2"	22660	22661	22662	100
6 x 3/4"	22663	22664	22665	100
6 x 1"	22666	22667	22668	100
8 x 1/2"	22669	22670	22671	100
8 x 3/4"	22672	22673	22674	100
8 x 1"	22675	22676	22677	100
8 x 1-1/4"	22678	22679	22680	100
8 x 1-1/2"	22681	22682	22683	100
10 x 1/2"	22684	22685	22686	100
10 x 3/4"	22687	22688	22689	100
10 x 1"	22690	22691	22692	100
10 x 1-1/4"	22693	22694	22695	100
10 x 1-1/2"	22696	22697	22698	100



Phillips Oval Head Sems® Countersunk Washer Tapping Screws

Size	Chrome Part No.	Unit Pkg.	Bk. Phos. Part No.	Unit Pkg.
6 x 5/8"	3537	100	11784	100
6 x 3/4"	3538	100	11785	100
6 x 1"	3539	100	11786	100
8 x 1/2" 6 Hd			*16930	100
8 x 5/8" 6 Hd	2771	100	11787	100
8 x 3/4" 6 Hd	2751	100	11788	100
8 x 1" 6 Hd	2772	100	11789	100
8 x 1-1/4" 6 Hd	2773	100	11790	100
8 x 1-1/2" 6 Hd	14970	50		
8 x 2"	24166	50		
10 x 1/2" 8 Hd			23805	50
10 x 5/8" 8 Hd	3465	100	14972	100
10 x 3/4" 8 Hd	3466	100	11791	50
10 x 1" 8 Hd	3467	100	11792	50
10 x 1-1/4" 8 Hd	3468	100	14973	50

*Black Oxide Finish



Square Drive Pan Head Tapping Screws

Size	Black Painted Head Part No.	Tan Painted Head Part No.	White Painted Head Part No.	Unit Pkg.
6 x 1/2"	25355	25356	25357	100
6 x 3/4"	25358	25359	25360	100
6 x 1"	25361	25362	25363	100
8 x 1/2"	25364	25365	25366	100
8 x 3/4"	25367	25368	25369	100
8 x 1"	25370	25371	25372	100
8 x 1-1/4"	25373	25374	25375	100
8 x 1-1/2"	25376	25377	25378	100
10 x 1/2"	25379	25380	25381	100
10 x 3/4"	25382	25383	25384	100
10 x 1"	25385	25386	25387	100
10 x 1-1/4"	25388	25389	25390	100
10 x 1-1/2"	25391	25392	25393	100

WARNING: ALL CHROME PARTS IN CHART
Reproductive Harm & Cancer
www.P65Warnings.ca.gov

TAPPING SCREWS

Listed According to Size



Phillips Oval Head Sems® Flush Washer Tapping Screws

Size		Chrome Part No.	Bk. Oxide Part No.	Unit Pkg.
8 x 1/2"	6 Hd		12956	100
8 x 5/8"	6 Hd	2774 ⚠	10652 ⚠	100
8 x 11/16"	6 Hd		10653	100
8 x 7/8"	6 Hd	2775 ⚠		100
8 x 1"	6 Hd		12957	100
8 x 1-1/4"	6 Hd		10654	100

⚠ **WARNING:** Reproductive Harm & Cancer
www.P65Warnings.ca.gov



Countersunk



Flush

Phillips Oval Head Sems® Tek® Finishing Screws with No. 6 Head & No. 2 Drill Point

Size	Washer Type	Chrome Part No.	Phos. Part No.	Unit Pkg.
8 x 5/8"	Flush	11448	11453	100
8 x 5/8"	Ctrsnk	11449		100
8 x 3/4"	Ctrsnk	11450	11455	100
8 x 1"	Ctrsnk	11451	11456	50
8 x 1-1/4"	Ctrsnk		11457	50
8 x 1-1/4"	Flush		18460	50

⚠ **WARNING:** ALL CHROME PARTS IN CHART
Reproductive Harm & Cancer
www.P65Warnings.ca.gov



Phillips Flat Top Washer Head Tapping Screws

Black E-Coat or Zinc

Size	Washer Head O.D.	Zinc Part No.	Black E-Coat Part No.	Unit Pkg.
6 x 1/2"	3/8"		12950	100
6 x 3/4"	3/8"		*12951	100
6 x 1"	3/8"		*12952	100
8 x 1/2"	13/32"	14859	12213	100
8 x 5/8"	13/32"	14860	12214	100
8 x 3/4"	13/32"	14861	12215	100
8 x 1"	13/32"	14862	12216	100
8 x 1-1/4"	13/32"		12217	50
8 x 1-1/4"	13/32"		23302	100
8 x 1-1/2"	13/32"		12218	50
8 x 2"	13/32"		19798	50
10 x 3/4"	15/32"		12953	50
10 x 1"	15/32"		12954	50
10 x 1-1/4"	15/32"		12955	50

*Black Oxide Finish

Round Washer Head Tapping Screws



Black or Zinc

Size	Washer Head	Zinc Part No.	Black Part No.	Unit Pkg.
8 x 1/2"	3/8"	24019		100
8 x 1/2"	1/2"	23775		100
8 x 3/4"	1/2"	23776		100
8 x 1"	13/32"		23631	100
8 x 1"	1/2"	23777		100
8 x 1-1/4"	1/2"	23778	23773	100
10 x 1-1/2"	1/2"		23774	100



Phillips Pan Head Sems® Tapping Screws

Black Phosphate

Auveco Part No.	Size	Washer O.D.	Unit Pkg.
12818	8 x 1/2"	1/2"	50
12820	8 x 3/4"	1/2"	50



Slotted Pan Head Type F Thread Cutting Screws

Bright Zinc Chromate

Auveco Part No.	Size	Unit Pkg.
5290	8-32 x 1/4"	100
5291	8-32 x 3/8"	100
5292	8-32 x 1/2"	100
5301	10-24 x 3/4"	100
5307	1/4"-20 x 5/8"	100

⚠ **WARNING:** ALL ITEMS IN CHART Reproductive Harm & Cancer
www.P65Warnings.ca.gov

TAPPING SCREWS

Listed According to Size



Indented Hex Washer Head Tapping Screws with Phillips Recess

Auveco Part No.	Size	Hex Size	Washer O.D.	Finish	Unit Pkg.
23619	8 x 3/4"	1/4"	3/8"	Zinc	100



Drill Screws

Bright Zinc Chromate

Pinch Point

Slotted Hex Washer Head Tapping Screws

Auveco Part No.	Size	Hex Size	Unit Pkg.
3367	6 x 3/8"	1/4"	100
3374	8 x 1/2"	1/4"	100
3376	8 x 3/4"	1/4"	100



Slotted Hex Washer Head Tapping Screws

Zinc Finish

Auveco Part No.	Size	Hex Size	Unit Pkg.
24139	14 x 1/2"	3/8"	100
24140	14 x 5/8"	3/8"	100
24029	14 x 1"	3/8"	100



Self-Piercing Screws

Zinc

For material thickness up to .060

Use with magnetic chuck 7767

Auveco Part No.	Size	Hex Size	Unit Pkg.
12367	8 x 5/8"	1/4"	100
12368	8 x 3/4"	1/4"	50
12369	10 x 1/2"	1/4"	50
12370	10 x 3/4"	1/4"	50

WARNING: Reproductive Harm & Cancer
www.P65Warnings.ca.gov



Hexagon Washer Head Type F Thread Cutting Screws

Bright Zinc Chromate

Auveco Part No.	Size	Hex Size	Unit Pkg.
5764	6-32 x 1"	1/4"	100
5766	8-32 x 3/8"	1/4"	100
5767	8-32 x 1/2"	1/4"	100
5768	8-32 x 5/8"	1/4"	100
5769	8-32 x 3/4"	1/4"	100
5773	10-24 x 3/8"	5/16"	100
5774	10-24 x 1/2"	5/16"	100
5775	10-24 x 5/8"	5/16"	100
5776	10-24 x 3/4"	5/16"	100
5778	10-24 x 1"	5/16"	100
8437	12-24 x 1/2"	5/16"	100
8438	12-24 x 3/4"	5/16"	100
8439	12-24 x 1"	5/16"	100
5781	1/4"-20 x 3/8"	3/8"	100
5782	1/4"-20 x 1/2"	3/8"	100
5783	1/4"-20 x 5/8"	3/8"	100
5784	1/4"-20 x 3/4"	3/8"	100
5786	1/4"-20 x 1"	3/8"	100
5787	1/4"-20 x 1-1/4"	3/8"	100
8441	5/16"-18 x 1/2"	1/2"	100
8442	5/16"-18 x 3/4"	1/2"	100
8443	5/16"-18 x 1"	1/2"	100
8444	5/16"-18 x 1-1/4"	1/2"	100
15355	5/16"-18 x 1-1/2"	1/2"	50
11294	3/8"-16 x 3/4"	9/16"	50
11295	3/8"-16 x 1"	9/16"	50
11296	3/8"-16 x 1-1/4"	9/16"	25
11297	3/8"-16 x 1-1/2"	9/16"	25
15358	3/8"-16 x 2"	9/16"	25

WARNING: ALL ITEMS IN CHART Reproductive Harm & Cancer
www.P65Warnings.ca.gov

TAPPING SCREWS

Listed According to Size



Teks® Self-Drilling Self-Tapping Screws

Size	Hex Size	Zinc Part No.	Unit Pkg.	Bk. Oxide Part No.	Unit Pkg.
------	----------	---------------	-----------	--------------------	-----------

Phillips Pan Head #2 Teks Point

8 x 7/16"		9604	100		
8 x 1/2"		9605	100	16033	100
8 x 5/8"				23792	100
8 x 3/4"		9606	100	16034	100
8 x 1"		11904	100	16035	50
8 x 1-1/2"				24132	100
10 x 1/2"		9607	100	16036	50
10 x 3/4"		9608	100	16037	50
10 x 1"		9609	100	16038	50
10 x 1-1/4"		24119	50		
12 x 1"		11905	50		

Hex Washer Head

#2 Teks Point

6 x 1/2"	1/4"	24110	100		
6 x 1"	1/4"	24111	100		
8 x 7/16"	1/4"	9610	100		
8 x 1/2"	1/4"	9611	100	16039	100
8 x 3/4"	1/4"	9612	100	16040	100
8 x 1"	1/4"	11906	100	16041	50
8 x 1-1/2"	1/4"	11908	50		
10 x 1/2"	5/16"	9613	100	16042	50
10 x 5/8"	5/16"	9614	100		
10 x 3/4"	5/16"	9615	100	16043	50
10 x 1"	5/16"	9616	100	16044	50

Super Teks® Hex Washer Head

#3 Teks Point

10 x 1-1/4"	5/16"	11909	50		
10 x 1-1/2"	5/16"	11910	50		
12 x 3/4"	5/16"	9617	100		
12 x 1"	5/16"	11911	25		
12 x 1-1/4"	5/16"	11912	25		
12 x 1-1/2"	5/16"	11913	25		
14 x 3/4"	3/8"	9620	100	24130	50
14 x 1"	3/8"	11914	25	24131	50
14 x 1-1/4"	3/8"	11915	25		
14 x 1-1/2"	3/8"	11916	25		
14 x 2"	3/8"	24112	25		

Teks Point Material Thickness

Screw Size	#2 Point	#3 Point
#8	.035" - .100"	.100" - .140"
#10	.035" - .110"	.110" - .175"
#12	.035" - .140"	.110" - .210"
#14	.035" - .175"	.110" - .210"

For an assortment of Teks Tapping Screws, see Fix-Kit No. 6144 in the green pages.



Phillips Oval Head Teks® Tapping Screws

Phosphate

Auveco Part No.	Size	Unit Pkg.
16736	8 x 1" 6 Hd	50



Indented Hex Head Tapping Screws

Bright Zinc Chromate

Auveco Part No.	Size	Hex Size	Unit Pkg.
2485	8 x 3/4"	1/4"	100
2487	10 x 3/4"	5/16"	100
3214	10 x 1-1/4"	5/16"	100
3215	10 x 1-1/2"	5/16"	100
1780	12 x 1/2"	5/16"	100
1781	14 x 3/4"	3/8"	100
2109	14 x 3/4"	7/16"	100
2266	14 x 1"	7/16"	100
2267	14 x 1-1/4"	7/16"	100
3219	14 x 1-1/2"	7/16"	100
2110	5/16" x 3/4"	1/2"	100
2268	5/16" x 1"	1/2"	100
2269	5/16" x 1-1/4"	1/2"	100
3220	5/16" x 1-1/2"	1/2"	100
5329	3/8" x 3/4"	9/16"	50
5330	3/8" x 1"	9/16"	50
5331	3/8" x 1-1/4"	9/16"	50
5332	3/8" x 1-1/2"	9/16"	50

Listed According to Size



Hexagon Washer Head Tapping Screws

Washer attached solid to Head

Size	Hex Size	Zinc Part No.	Unit Pkg.	Bk. Oxide Part No.	Unit Pkg.
10 x 1/2"	5/16"	2369	100	16149	100
10 x 5/8"	5/16"	2809	100		
12 x 5/8"	5/16"	2967	100		
12 x 3/4"	5/16"	2968	100		
12 x 1"	5/16"	2969	100		
14 x 1/2"	3/8"	9825	100		
14 x 5/8"	3/8"	2370	100		
14 x 3/4"	3/8"	2330	100	16152	100
14 x 3/4"	7/16"	2973	100		
14 x 1"	3/8"	2974	100		
14 x 1-1/2"	3/8"	2976	100		
5/16" x 3/4"	7/16"	2978	100		
5/16" x 1"	7/16"	2979	100		
5/16" x 1-1/4"	7/16"	2980	100		
5/16" x 1-1/2"	7/16"	2981	100		

⚠️ WARNING: Reproductive Harm & Cancer
www.P65Warnings.ca.gov



Hexagon Head Sems® Tapping Screws

Bright Zinc Chromate
 Washer loose from Head

Auveco Part No.	Size	Hex Size	Washer O.D.	Unit Pkg.
2604	14 x 3/4"	3/8"	5/8"	100
24433	14 x 3/4"	3/8"	11/16"	50
2988	14 x 3/4"	7/16"	21/32"	100
2605	14 x 1"	3/8"	21/32"	100
2989	14 x 1"	7/16"	21/32"	100
2991	14 x 1-1/2"	7/16"	21/32"	100
2994	5/16" x 1"	7/16"	11/16"	100
2996	5/16" x 1-1/2"	7/16"	11/16"	100

⚠️ WARNING: ALL ITEMS IN CHART Reproductive Harm & Cancer
www.P65Warnings.ca.gov



Slotted Hexagon Washer Head Tapping Screws

Bright Zinc Chromate

Auveco Part No.	Size	Hex Size	Unit Pkg.
3367	6 x 3/8"	1/4"	100
3368	6 x 1/2"	1/4"	100
3369	6 x 5/8"	1/4"	100
3373	8 x 3/8"	1/4"	100
3374	8 x 1/2"	1/4"	100
3375	8 x 5/8"	1/4"	100
3376	8 x 3/4"	1/4"	100
3378	8 x 1"	1/4"	100
3379	8 x 1-1/4"	1/4"	100
3381	10 x 1/2"	5/16"	100
3382	10 x 5/8"	5/16"	100
3383	10 x 3/4"	5/16"	100
3385	10 x 1"	5/16"	100
3387	10 x 1-1/2"	5/16"	100
3388	12 x 1/2"	5/16"	100
3390	12 x 3/4"	5/16"	100
3392	12 x 1"	5/16"	100
3393	12 x 1-1/4"	5/16"	100
3394	12 x 1-1/2"	5/16"	100

⚠️ WARNING: ALL ITEMS IN CHART Reproductive Harm & Cancer
www.P65Warnings.ca.gov

TAPPING SCREWS

Listed According to Size



Phillips Square Combo Drive Teks® Liner Screws
with Locking Wedges under Head
Yellow Zinc

Auveco Part No.	Size	Head Dia.	Unit Pkg.
21731	10 x 3/4"	5/8"	50
21732	10 x 1"	5/8"	50
21733	10 x 1-1/4"	5/8"	50



Torx® Wafer Head Teks® Liner Screws
Zinc

Auveco Part No.	Size	Head Dia.	Drive Size	Unit Pkg.
21735	10 x 1"	15/32"	T-25	50
21736	10 x 1-1/4"	15/32"	T-25	50
21737	10 x 1-1/2"	15/32"	T-25	50



Flat Head Torx® Drive Floor Screws
Type F Thread Cutting Point

Phosphate & Oil

Auveco Part No.	Size	Drive Size	Unit Pkg.	Auveco Part No.	Size	Drive Size	Unit Pkg.
21717	1/4"-20 x 2"	T-30	50	21726	5/16"-18 x 2-1/2"	T-40	25
21718	1/4"-20 x 2-1/2"	T-30	50	21730	5/16"-18 x 5"	T-40	10
21719	1/4"-20 x 3"	T-30	25				

Torx® Insert Bits for Torx Screws

1" Shank



Auveco Part No.	Size	Drive Size	Unit Pkg.	Auveco Part No.	Size	Drive Size	Unit Pkg.
12472	T-10	No. 4	1	14913	T-27	No. 12, 1/4"	1
11949	T-15	No. 6, 8, M4.2	1	12104	T-30	1/4"	1
11950	T-20	No. 8, M4.2	1	12105	T-40	5/16"	1
12103	T-25	No. 10	1				

Torx Tools

Torx Short Arm Key, Power Drive Bits and Hand Drivers are available for installing Torx Screws. Refer to the "Tools" listing in the Alphabetical Index.



Phillips Flat Head Wood Screws

Steel • Zinc Plated

Auveco Part No.	Size	Unit Pkg.	Auveco Part No.	Size	Unit Pkg.
9555	6 x 1/2"	100	9571	10 x 1-1/4"	100
9556	6 x 3/4"	100	9572	10 x 1-1/2"	100
9564	8 x 3/4"	100	9575	12 x 1"	100
9565	8 x 1"	100	9576	12 x 1-1/4"	100
9566	8 x 1-1/4"	100	9577	12 x 1-1/2"	100
9568	8 x 1-3/4"	100	9582	14 x 2"	100
9569	10 x 3/4"	100			
9570	10 x 1"	100			



Hex Washer Head Spin Lock Bolts Grade 2 • Phosphate

Auveco Part No.	Size	Hex	Washer Head O.D.	Unit Pkg.
2753*	1/4"-20 x 5/8"	3/8"	5/8"	100
3615	5/16"-18 x 3/4"	1/2"	13/16"	100
5711	5/16"-18 x 1"	1/2"	13/16"	50
5713	5/16"-18 x 1-1/4"	1/2"	13/16"	50
2688	5/16"-24 x 1"	1/2"	13/16"	50

*Not Dog Point



Phillips Oval Head Machine Screws Steel • Zinc Plated

Size	Chrome Part No.	Zinc Part No.	Unit Pkg.
6-32 x 3/8"		16362	100
6-32 x 1/2"		16363	100
6-32 x 3/4"			100
6-32 x 1-1/4"		16365	100
8-32 x 1/2"		16368	100
8-32 x 3/4"		16369	100
8-32 x 3/4"	6 Hd 1863	▲	100
8-32 x 1"		16370	100
8-32 x 1-1/4"		16371	100
8-32 x 1-1/2"		16372	50
10-24 x 1/2"		1877	▲ 100
10-24 x 3/4"	1934	▲ 16375	100
10-24 x 1"		16376	100
10-32 x 1/2"		16380	100
10-32 x 3/4"		16381	100
10-32 x 1"	8 Hd 1413	▲	100
10-32 x 1"		16382	100
10-32 x 1-1/4"		16383	50
10-32 x 1-1/2"		16384	50
1/4"-20 x 1/2"		16385	50
1/4"-20 x 3/4"		16386	50
1/4"-20 x 1"		16387	50
1/4"-20 x 1-1/2"		16389	50

▲ **WARNING:** Reproductive Harm & Cancer
www.P65Warnings.ca.gov



Slotted Oval Head Machine Screws

Auveco Part No.	Zinc Plated Size	Unit Pkg.
2354	10-24 x 1-1/2"	100

For the most up to date information on all Auveco items, including new items, inventory and online ordering please visit

auveco.com



Round Head Stove Bolts & Hex Nuts Bright Zinc Chromate U.S.S. Coarse Thread

Auveco Part No.	Size	Unit Pkg.
3711	3/16" x 1/2"	100
3712	3/16" x 3/4"	100
3713	3/16" x 1"	100
3715	3/16" x 1-1/2"	100
3717	3/16" x 2"	100
3718	1/4" x 1/2"	100
3720	1/4" x 1"	100
3722	1/4" x 1-1/2"	100
3724	1/4" x 2"	100

▲ **WARNING:** ALL ITEMS IN CHART Reproductive Harm & Cancer
www.P65Warnings.ca.gov



Phillips Pan Head Machine Screws Zinc Plated

Auveco Part No.	Size	Unit Pkg.
15374	6-32 x 3/8"	100
15375	6-32 x 1/2"	100
15376	6-32 x 3/4"	100
15377	6-32 x 1"	100
15378	6-32 x 1-1/4"	100
15379	6-32 x 1-1/2"	100
15380	8-32 x 3/8"	100
15381	8-32 x 1/2"	100
15382	8-32 x 3/4"	100
15383	8-32 x 1"	100
15385	8-32 x 1-1/2"	100
15386	10-24 x 3/8"	100
15387	10-24 x 1/2"	100
15388	10-24 x 3/4"	100
15389	10-24 x 1"	100
15390	10-24 x 1-1/4"	100
15391	10-24 x 1-1/2"	50
15392	10-32 x 3/8"	100
15393	10-32 x 1/2"	100
15394	10-32 x 3/4"	100
15395	10-32 x 1"	100
15396	10-32 x 1-1/4"	100
15397	10-32 x 1-1/2"	50
15398	1/4"-20 x 1/2"	100
15399	1/4"-20 x 3/4"	100
15400	1/4"-20 x 1"	50
15401	1/4"-20 x 1-1/4"	50
15402	1/4"-20 x 1-1/2"	50
15404	1/4"-20 x 2"	50



Slotted Round Head Machine Screws Bright Zinc Chromate

Auveco Part No.	Size	Unit Pkg.
5700	6-32 x 3/8"	100
2530	6-32 x 1/2"	100
2531	6-32 x 3/4"	100
2532	6-32 x 1"	100
8588	6-32 x 1-1/2"	100
5702	8-32 x 3/8"	100
2533	8-32 x 1/2"	100
2534	8-32 x 3/4"	100
2535	8-32 x 1"	100
8590	10-32 x 3/8"	100
2536	10-32 x 1/2"	100
2538	10-32 x 1"	100
2539	10-32 x 1-1/4"	100
2540	10-32 x 1-1/2"	100
2541	10-24 x 1/2"	100
2542	10-24 x 3/4"	100
2543	10-24 x 1"	100
2544	10-24 x 1-1/4"	100
2545	10-24 x 1-1/2"	100
8594	10-24 x 2"	100
2546	12-24 x 1/2"	100
5704	12-24 x 3/4"	100
2548	12-24 x 1"	100
2550	12-24 x 1-1/2"	100
8029	1/4"-20 x 1/2"	100
8033	1/4"-20 x 1-1/2"	100
8035	1/4"-20 x 2"	100

WARNING: ALL ITEMS IN CHART Reproductive Harm & Cancer
www.P65Warnings.ca.gov



Phillips Round Head Machine Screws Zinc Plated

Auveco Part No.	Size	Unit Pkg.
16407	6-32 x 1/2"	100
16411	8-32 x 1"	100
16412	10-32 x 1/2"	100
16416	10-24 x 3/4"	100

Sec. 02

MISCELLANEOUS SCREWS



Carriage Bolts with Hex Nuts

U.S.S. Coarse Thread • Grade 2 • Zinc Plated

Auveco Part No.	Size	Unit Pkg.
9482	1/4" x 1"	50
9483	1/4" x 1-1/2"	50
9484	1/4" x 2"	50
9485	1/4" x 2-1/2"	50
9486	1/4" x 3"	50
9487	1/4" x 4"	25
9489	1/4" x 6"	25
9490	5/16" x 1"	50
9491	5/16" x 1-1/2"	50
9492	5/16" x 2"	25

Auveco Part No.	Size	Unit Pkg.
9493	5/16" x 3"	25
9494	5/16" x 4"	25
9498	3/8" x 1"	25
9499	3/8" x 1-1/2"	25
9500	3/8" x 2"	25
9501	3/8" x 3"	25
9502	3/8" x 4"	25
9507	1/2" x 2"	10
9509	1/2" x 4"	10
9510	1/2" x 6"	10

Socket Head Set Screws

Cup Point



Auveco Part No.	Size	Unit Pkg.	Use Tool No.
5365	6-32 x 3/16"	50	5414
5366	6-32 x 1/4"	50	5414
5367	6-32 x 5/16"	50	5414
5368	6-32 x 3/8"	50	5414
5369	8-32 x 3/16"	50	5415
5370	8-32 x 1/4"	50	5415
5371	8-32 x 5/16"	50	5415
5372	8-32 x 3/8"	50	5415
5373	8-32 x 1/2"	50	5415

Part No. U.S.S.	Part No. S.A.E.	Size	Unit Pkg.	Use Tool No.
#10 U.S.S. (Coarse) Threads Per Inch: 24 S.A.E. (Fine) Threads Per Inch: 32				
5394	5394	10 x 3/16"	50	
5375	5395	10 x 1/4"	50	
5376	5396	10 x 5/16"	50	
5377		10 x 3/8"	50	
5378	5398	10 x 1/2"	50	

Part No. U.S.S.	Part No. S.A.E.	Size	Unit Pkg.	Use Tool No.
1/4" U.S.S. (Coarse) Threads Per Inch: 20 S.A.E. (Fine) Threads Per Inch: 28				
5379	5399	1/4 x 1/4"	50	
5380	5400	1/4 x 5/16"	50	
5381	5401	1/4 x 3/8"	50	
5382	5402	1/4 x 7/16"	50	
5383	5403	1/4 x 1/2"	50	

Part No. U.S.S.	Part No. S.A.E.	Size	Unit Pkg.	Use Tool No.
5/16" U.S.S. (Coarse) Threads Per Inch: 18 S.A.E. (Fine) Threads Per Inch: 24				
5404	5404	5/16 x 1/4"	50	
5385		5/16 x 5/16"	50	
5386	5406	5/16 x 3/8"	50	
5387		5/16 x 7/16"	50	
5388	5408	5/16 x 1/2"	50	

Part No. U.S.S.	Part No. S.A.E.	Size	Unit Pkg.	Use Tool No.
3/8" U.S.S. (Coarse) Threads Per Inch: 16 S.A.E. (Fine) Threads Per Inch: 24				
5409	5409	3/8 x 5/16"	25	7978*
5390	5410	3/8 x 3/8"	25	7978*
5391	5411	3/8 x 7/16"	25	7978*
5392	5412	3/8 x 1/2"	25	7978*
5393	5413	3/8 x 5/8"	25	7978*

Part No. U.S.S.	Part No. S.A.E.	Size	Unit Pkg.	Use Tool No.
1/2" U.S.S. (Coarse) Threads Per Inch: 13 S.A.E. (Fine) Threads Per Inch: 20				
15903		1/2 x 1/2"	25	7978*

*Fold-up Key Set

Note: All Socket Wrenches packed 10 per Unit Package except Key Set 7978 which is packed 1 per Unit Package

All Items Phosphate & Oil

Auveco flange bolts and locknuts form a strong and dependable fastening system that substantially cuts truck assembly, maintenance and repair costs. The flange bolts are made to IFI III industry standard specifications. When flange bolts are used in conjunction with the flange locknuts they form a 150,000 P.S.I. tensile strength fastening system equivalent to SAE J429, Grade 8 industry standard specification. Flat washers and lock washers are not needed with the flange bolts. Our flange fastening system also reduces the need for costly hole preparations such as deburring and countersinking.



Product Specifications

Product Diameter	Flange & Nut Diameter	Screw & Nut Across Flats	Screw Head Height	Nut Height	Minimum Screw Thread Length
3/8"	.780"/.810"	.551"/.562"	.370"/.390"	.415"/.425"	1"
1/2"	1.031"/1.070"	.736"/.750"	.490"/.510"	.545"/.555"	1-1/4"
5/8"	1.300"/1.330"	.922"/.937"	.600"/.620"	.680"/.690"	1-1/2"
3/4"	1.510"/1.565"	1.110"/1.125"	.710"/.730"	.740"/.750"	1-3/4"

Grade 8 Hex Flange Bolts

Size	Auveco Part No. U.S.S.	U.S.S. Unit Pkg.	S.A.E.	Unit Pkg.
3/8"	U.S.S. (Coarse) Threads Per Inch: 16			
3/8 x 1"	17561*	25		
3/8 x 1-1/4"	17562*	25		
3/8 x 1-1/2"	17563	25		
3/8 x 1-3/4"	17564	25		
Size	Auveco Part No. U.S.S.	U.S.S. Unit Pkg.	Auveco Part No. S.A.E.	S.A.E. Unit Pkg.
1/2"	U.S.S. (Coarse) Threads Per Inch: 13 S.A.E. (Fine) Threads Per Inch: 20			
1/2 x 1"	17565*	25	14487*	10
1/2 x 1-1/4"	17566*	25		
1/2 x 1-1/2"			14489*	10
1/2 x 1-3/4"			14490*	10
1/2 x 2"	17569	15	14491	10
1/2 x 2-1/4"	17570	15		
1/2 x 3"	17573	15		
1/2 x 3-1/4"	17574	15		
1/2 x 3-1/2"	17575	15		

Size	Auveco Part No. U.S.S.	U.S.S. Unit Pkg.	Auveco Part No. S.A.E.	S.A.E. Unit Pkg.
5/8"	U.S.S. (Coarse) Threads Per Inch: 11 S.A.E. (Fine) Threads Per Inch: 18			
5/8 x 1-3/4"	17577*	10	14494*	10
5/8 x 2"	17578*	10	14495*	10
5/8 x 2-1/4"	17579*	10		10
5/8 x 2-1/2"	17580	10	14497	10
5/8 x 3"	17582	10	14499	10
5/8 x 3-1/2"	17584	10		

*Items threaded to the head

Hex Flange Locknuts

Auveco Part No.	Size	Unit Pkg.	Auveco Part No.	Size	Unit Pkg.
12517	3/8"-16 (Coarse)	50	12519	5/8"-11 (Coarse)	25
12518	1/2"-13 (Coarse)	25	14501	5/8"-18 (Fine)	25
14500	1/2"-20 (Fine)	25	15180	3/4"-10 (Coarse)	10

CAP SCREWS

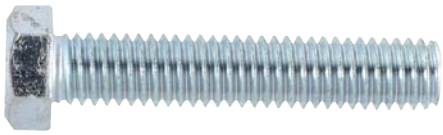

24005

Zinc Plated

Hex Head Body Tap Bolt

3/8"-16 x 2"

Grade 2

Full Thread

UNIT PACKAGE: 100



Grade 5

Bright Zinc Chromate

Medium Carbon Heat Treated Steel



120,000 P.S.I. Minimum Tensile Strength, Head is Identified with 3 Radial Lines

Size	Part No. U.S.S.	Part No. S.A.E.	Unit Pkg.
1/4"	U.S.S. (Coarse) Threads Per Inch: 20 S.A.E. (Fine) Threads Per Inch: 28		
1/4 x 1/2"	*5434	*5495	100
1/4 x 5/8"	*5435		100
1/4 x 3/4"	*5436	*5497	100
1/4 x 1"	*5438	*5499	100
1/4 x 1-1/4"	5439	5500	100
1/4 x 1-1/2"	5440	5501	100
1/4 x 1-3/4"	5441		100
1/4 x 2"	5442		100
1/4 x 2-1/4"	5443		100
1/4 x 2-1/2"	5444	5505	100
1/4 x 2-3/4"	5445		100
1/4 x 3"	5446		100
1/4 x 3-1/2"	8449		100

Size	Part No. U.S.S.	Part No. S.A.E.	Unit Pkg.
5/16"	U.S.S. (Coarse) Threads Per Inch: 18 S.A.E. (Fine) Threads Per Inch: 24		
5/16 x 1/2"	*5447		100
5/16 x 5/8"	*5448		100
5/16 x 3/4"	*5449	*5510	100
5/16 x 7/8"	*5450		100
5/16 x 1"	*5451	*5512	100
5/16 x 1-1/4"	*5452		100
5/16 x 1-1/2"	5453	5514	100
5/16 x 1-3/4"	5454		100
5/16 x 2"	5455	5516	50
5/16 x 2-1/4"	5456		50
5/16 x 2-1/2"	5457		50
5/16 x 3"	5459		50
5/16 x 4"	8450		50

Size	Part No. U.S.S.	Part No. S.A.E.	Unit Pkg.
3/8"	U.S.S. (Coarse) Threads Per Inch: 16 S.A.E. (Fine) Threads Per Inch: 24		
3/8 x 5/8"	*5462		50
3/8 x 3/4"	*5463	*5524	50
3/8 x 7/8"	*5464		50
3/8 x 1"	*5465	*5526	50
3/8 x 1-1/4"	*5466	*5527	50
3/8 x 1-1/2"	5467	5528	50
3/8 x 1-3/4"	5468		50
3/8 x 2"	5469	5530	50
3/8 x 2-1/4"	5470		50
3/8 x 2-1/2"	5471		50
3/8 x 3"	5472		50
3/8 x 3-1/2"	5473		50
3/8 x 4"	5474		50
3/8 x 4-1/2"	8096		25
3/8 x 5"	8097		25

*Items threaded to head

Size	Part No. U.S.S.	Part No. S.A.E.	Unit Pkg.
7/16"	U.S.S. (Coarse) Threads Per Inch: 14 S.A.E. (Fine) Threads Per Inch: 20		
7/16 x 3/4"	*5475		50
7/16 x 1"	*5476	*5537	50
7/16 x 1-1/4"	*5477	*5538	50
7/16 x 1-1/2"	*5478	*5539	50
7/16 x 1-3/4"	5479		50
7/16 x 2"	5480		25
7/16 x 2-1/2"	5481	5542	25
7/16 x 3"	5482		25
7/16 x 3-1/2"	5483		25
7/16 x 4"	5484		25

Size	Part No. U.S.S.	Part No. S.A.E.	Unit Pkg.
1/2"	U.S.S. (Coarse) Threads Per Inch: 13 S.A.E. (Fine) Threads Per Inch: 20		
1/2 x 3/4"	*5485		50
1/2 x 1"	*5486	*5547	50
1/2 x 1-1/4"	*5487		50
1/2 x 1-1/2"	*5488		25
1/2 x 1-3/4"	*5489	*5550	25
1/2 x 2"	5490	5551	25
1/2 x 2-1/2"	5491		25
1/2 x 3"	5492	5553	25
1/2 x 3-1/2"	5493		25
1/2 x 4"	5494		25
1/2 x 4-1/2"	8104		25
1/2 x 5"	8105		25
1/2 x 6"	8107		25

Size	Part No. U.S.S.	Part No. S.A.E.	Unit Pkg.
5/8"	U.S.S. (Coarse) Threads Per Inch: 11 S.A.E. (Fine) Threads Per Inch: 18		
5/8 x 1"	*9520		25
5/8 x 1-1/2"		*9528	25
5/8 x 2"	*9522		25
5/8 x 3"	9524		25
5/8 x 3-1/2"	9525		25
5/8 x 4"	9526		25

Size	Part No. U.S.S.	Unit Pkg.
3/4"	U.S.S. (Coarse) Threads Per Inch: 10	
3/4 x 2"	*8453	10
3/4 x 2-1/2"	*8454	10
3/4 x 3"	8455	10
3/4 x 3-1/2"	8456	10

*Items threaded to head

WARNING: ALL ITEMS IN CHART Reproductive Harm & Cancer
www.P65Warnings.ca.gov

Refer to assortment 1020 in the green pages

CAP SCREWS

Sec. 02



Grade 8

Yellow Zinc Dichromate
Medium Carbon Alloy Steel

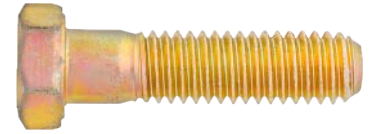

150,000 P.S.I. Minimum Tensile Strength, Head is Identified with 6 Radial Lines

Size	Part No. U.S.S.	Part No. S.A.E.	Unit Pkg.
1/4"	U.S.S. (Coarse) Threads Per Inch: 20 S.A.E. (Fine) Threads Per Inch: 28		
1/4 x 1/2"	*9118		50
1/4 x 3/4"	*9119		50
1/4 x 1"	*9120		50
1/4 x 1-1/4"	9121		50
1/4 x 1-1/2"	9122	9177	50
1/4 x 2"	9124		50
1/4 x 2-1/4"	9125		25
1/4 x 2-1/2"	9126		25

Size	Part No. U.S.S.	Part No. S.A.E.	Unit Pkg.
5/16"	U.S.S. (Coarse) Threads Per Inch: 18 S.A.E. (Fine) Threads Per Inch: 24		
5/16 x 1/2"	*9127		50
5/16 x 3/4"	*9128		50
5/16 x 1"	*9129	*9184	50
5/16 x 1-1/4"	*9130		50
5/16 x 1-1/2"	9131	9186	50
5/16 x 1-3/4"	9132		50
5/16 x 2"	9133	9188	50
5/16 x 2-1/2"	9134		25
5/16 x 3"	9135		25

Size	Part No. U.S.S.	Part No. S.A.E.	Unit Pkg.
3/8"	U.S.S. (Coarse) Threads Per Inch: 16 S.A.E. (Fine) Threads Per Inch: 24		
3/8 x 3/4"	*9136	*9191	50
3/8 x 1"	*9137	*9192	50
3/8 x 1-1/4"	*9138	*9193	50
3/8 x 1-1/2"	9139	9194	50
3/8 x 2"	9140		25
3/8 x 2-1/2"	9141		25
3/8 x 3"	9142		25
3/8 x 3-1/2"	17028		15
3/8 x 4"	9143		25

*Items threaded to head

Size	Part No. U.S.S.	Part No. S.A.E.	Unit Pkg.
7/16"	U.S.S. (Coarse) Threads Per Inch: 14 S.A.E. (Fine) Threads Per Inch: 20		
7/16 x 1"	*9144	*9199	25
7/16 x 1-1/4"	*9145		25
7/16 x 1-1/2"	*9146	*9201	25
7/16 x 2"	9147		25
7/16 x 2-1/2"	9148	9203	25
7/16 x 3"	9149		25
7/16 x 4"	9150		25

Size	Part No. U.S.S.	Part No. S.A.E.	Unit Pkg.
1/2"	U.S.S. (Coarse) Threads Per Inch: 13 S.A.E. (Fine) Threads Per Inch: 20		
1/2 x 1"	*9151		25
1/2 x 1-1/4"	*9152		25
1/2 x 1-1/2"	*9153	*9208	25
1/2 x 1-3/4"	*9154		25
1/2 x 2"	9155	9210	25
1/2 x 2-1/2"	9156		25
1/2 x 3"	9157	9212	10
1/2 x 4"	9158		10
1/2 x 5"	9159		10

Size	Part No. U.S.S.	Part No. S.A.E.	Unit Pkg.
5/8"	U.S.S. (Coarse) Threads Per Inch: 11 S.A.E. (Fine) Threads Per Inch: 18		
5/8 x 1-1/2"	*9160		10
5/8 x 2"	*9161		10
5/8 x 2-1/2"	9162		10
5/8 x 3"	9163		10
5/8 x 3-1/2"	17499		10
5/8 x 4"	9164	9219	10
5/8 x 5"	9165		10

Size	Part No. U.S.S.	Part No. S.A.E.	Unit Pkg.
3/4"	U.S.S. (Coarse) Threads Per Inch: 10 S.A.E. (Fine) Threads Per Inch: 16		
3/4 x 2"	*9167		10
3/4 x 3"	9169	9224	10
3/4 x 3-1/2"	9170		10
3/4 x 4"	9171		10

*Items threaded to head

Refer to assortment 1030 in the green pages

WARNING: ALL ITEMS ON PAGE Reproductive Risk & Cancer www.P65Warnings.ca.gov



Stainless Steel Phillips Pan Head Tapping Screws

Auveco Part No.	Size	Unit Pkg.
13265	6 x 1/2"	100
13266	6 x 3/4"	100
13267	6 x 1"	100
13268	6 x 1-1/4"	100
13269	8 x 1/2"	100
13270	8 x 3/4"	50
13271	8 x 1"	50
13272	8 x 1-1/4"	50
13273	8 x 1-1/2"	25
13274	10 x 1/2"	100
13275	10 x 3/4"	50
13276	10 x 1"	50
13277	10 x 1-1/4"	50
13278	10 x 1-1/2"	25
13279	10 x 1-3/4"	25
13280	12 x 1/2"	50
13281	12 x 3/4"	50
13282	12 x 1"	50
13284	12 x 1-1/2"	25
21609	14 x 3/4"	100



Stainless Steel Slotted Round Head Machine Screws

Auveco Part No.	Size	Unit Pkg.
13293	6-32 x 1/4"	100
13294	6-32 x 1/2"	100
13298	8-32 x 1/4"	100
13299	8-32 x 1/2"	100
13300	8-32 x 3/4"	100
13304	10-24 x 1/2"	100
13306	10-24 x 1"	50
13311	10-32 x 3/4"	100
13312	10-32 x 1"	50



Stainless Steel Phillips Oval Head Tapping Screws

Auveco Part No.	Size	Unit Pkg.
9399	6 x 1/2"	100
9400	6 x 3/4"	100
9401	6 x 1"	100
9402	6 x 1-1/4"	100
9403	8 x 1/2"	100
9404	8 x 3/4"	100
9405	8 x 1"	100
9406	8 x 1-1/4"	100
9407	8 x 1-1/2"	100
9408	10 x 1/2"	100
9409	10 x 3/4"	100
9410	10 x 1"	100
9411	10 x 1-1/4"	100
9412	10 x 1-1/2"	100
13286	10 x 1-3/4"	25
13288	12 x 3/4"	50
13289	12 x 1"	50
13290	12 x 1-1/4"	25
13291	12 x 1-1/2"	25



Stainless Steel Phillips Oval Head Machine Screws

Auveco Part No.	Size	Unit Pkg.
13322	6-32 x 1/2"	100
13323	6-32 x 3/4"	100
13324	6-32 x 1"	100
13325	6-32 x 1-1/4"	100
13326	8-32 x 1/4"	100
13327	8-32 x 1/2"	100
13328	8-32 x 3/4"	100
13329	8-32 x 1"	100
13330	8-32 x 1-1/4"	50
13331	10-24 x 1/2"	100
13332	10-24 x 3/4"	50
13333	10-24 x 1"	50
13334	10-24 x 1-1/4"	50
13335	10-24 x 1-1/2"	50
13336	10-32 x 1/2"	100
13337	10-32 x 3/4"	50
13339	10-32 x 1-1/4"	50
13340	10-32 x 1-1/2"	50
13341	1/4"-20 x 1/2"	50
13342	1/4"-20 x 3/4"	50
13343	1/4"-20 x 1"	25
13344	1/4"-20 x 1-1/4"	25
13345	1/4"-20 x 1-1/2"	25

STAINLESS STEEL

18-8 (300 SERIES)



U.S.S. Coarse Thread Stainless Steel Hex Head Cap Screws

Auveco Part No.	Bolt Size	Unit Pkg.	Auveco Part No.	Bolt Size	Unit Pkg.
13346*	1/4"-20 x 1/2"	50	13362*	3/8"-16 x 1/2"	50
13347*	1/4"-20 x 3/4"	50	13364*	3/8"-16 x 1"	50
13348	1/4"-20 x 1"	50	13365	3/8"-16 x 1-1/4"	25
13349	1/4"-20 x 1-1/4"	50	13366	3/8"-16 x 1-1/2"	25
13350	1/4"-20 x 1-1/2"	50	13367	3/8"-16 x 1-3/4"	25
13352	1/4"-20 x 2"	25	13368	3/8"-16 x 2"	25
13353*	5/16"-18 x 1/2"	50	13370	3/8"-16 x 2-1/2"	25
13354*	5/16"-18 x 3/4"	25	13391	3/8"-16 x 3"	25
13355	5/16"-18 x 1"	25	13374*	1/2"-13 x 1-1/4"	10
13356	5/16"-18 x 1-1/4"	25	13377	1/2"-13 x 2"	10
13357	5/16"-18 x 1-1/2"	25			
13361	5/16"-18 x 2-1/2"	25			

*Items threaded to head

Stainless Steel Cotter Pins

Extended Prong Type



Auveco Part No.	Size	Rec. Hole Size	Unit Pkg.
13409	1/16" x 3/4"	.078	100
13411	3/32" x 1/2"	.109	100
13413	3/32" x 1"	.109	100
13414	3/32" x 1-1/4"	.109	50
13420	1/8" x 1"	.141	50
13421	1/8" x 1-1/4"	.141	50
13422	1/8" x 1-1/2"	.141	50



Stainless Steel Wing Nuts

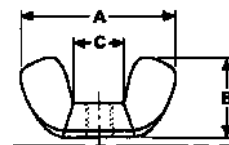

Auveco Part No.	Size	Wing Spread (A)		Overall Height (B)		Between Wing (C)		Unit Pkg.
		Max.	Min.	Max.	Min.	Max.	Min.	
13256	10-24	.91	.78	.47	.34	.27	.22	25
13258	1/4"-20	1.10	.97	.57	.43	.39	.26	25

STAINLESS STEEL

18-8 (300 SERIES)



Stainless Steel Hex Machine Screw Nuts

Auveco Part No.	Size	Hex Width	Unit Pkg.
13260	6-32	5/16"	100
13261	8-32	11/32"	100
13262	10-24	3/8"	100
13263	10-32	3/8"	100
13264	1/4"-20	7/16"	100



Stainless Steel Acorn Nuts

Auveco Part No.	Size	Hex Width	Unit Pkg.
13248	6-32	5/16"	25
13252	1/4"-20	7/16"	25



Stainless Steel Hex Nuts

Auveco Part No.	Size	Hex Width	Thick-ness	Unit Pkg.
13234	1/4"-20	7/16"	7/32"	100
13235	5/16"-18	1/2"	17/64"	50
13236	3/8"-16	9/16"	21/64"	50
13237	1/2"-13	3/4"	7/16"	25



Stainless Steel Nylon Insert Lock Nuts

Auveco Part No.	Size	Hex Width	Unit Pkg.
13239	6-32	5/16"	50
13240	8-32	11/32"	50
13241	10-24	3/8"	50
13242	10-32	3/8"	50
13243	1/4"-20	7/16"	50
13244	5/16"-18	1/2"	25
13245	3/8"-16	9/16"	25
13246	1/2"-13	3/4"	10



Stainless Steel Medium Split Washers

Auveco Part No.	Size	O.D.	Thick-ness	Unit Pkg.
13401	#8	19/64"	.040	100
13402	#10 (3/16")	21/64"	.047	100
13403	1/4"	31/64"	.062	100
13404	5/16"	19/32"	.078	100
13405	3/8"	11/16"	.094	100
13406	1/2"	7/8"	.125	50



Stainless Steel Flat Washers

Auveco Part No.	Bolt Size	I.D.	O.D.	Thick-ness	Unit Pkg.
13392	#6 (1/8")	9/64"	3/8"	.030	100
13393	#8	5/32"	3/8"	.030	100
13394	#10 (3/16")	7/32"	7/16"	.030	100
13395	1/4"	9/32"	5/8"	.043	100
13396	5/16"	11/32"	3/4"	.050	100
13397	3/8"	13/32"	7/8"	.060	50
13398	1/2"	33/64"	1-1/4"	.060	50



LockOne

Fast & easy to install-no special tools required
 Corrosion resistant, 304 Stainless Steel
 Reusable, does not degrade with each cycle
 Vibration-Proof, positive locking force
 Designed for harsh environments
 Ideal for weight sensitive applications

Auveco Part No.	Thread Size	Hex	U.S.S. (Coarse) Thickness	Wire Width	Weight	Unit Pkg.
22866	1/4-20	0.43	0.11	0.03	0.80 g	10
22868	3/8-16	0.55	0.13	0.04	1.30 g	10
22869	1/2-13	0.75	0.16	0.05	3.00 g	10

BUMPER BOLTS

Listed According to Size



Round Polished Stainless Steel Capped Heads
Zinc Plated



With Lock Nuts



With Hex Nuts

Auveco Part No.	Size	Head Style	Head Diameter		Unit Pkg.
5714*	5/16"-18 x 7/8"	Round	11/16"	without Nuts	25
5238	3/8"-16 x 7/8"	Round	27/32"	without Nuts	25
3414	3/8"-16 x 7/8"	Round	27/32"	with Hex Nuts	25
3432	3/8"-16 x 7/8"	Round	27/32"	with Lock Nuts	25
3415	3/8"-16 x 1"	Round	27/32"	with Hex Nuts	25
3433	3/8"-16 x 1"	Round	27/32"	with Lock Nuts	25
8626	7/16"-14 x 7/8"	Round	31/32"	without Nuts	25
8627	7/16"-14 x 7/8"	Round	31/32"	with Hex Nuts	25
8552	7/16"-14 x 1"	Round	31/32"	without Nuts	25
8557	7/16"-14 x 1"	Round	31/32"	with Hex Nuts	25
8562	7/16"-14 x 1"	Round	31/32"	with Lock Nuts	25
3099	7/16"-14 x 1-1/4"	Round	31/32"	with Hex Nuts	10
3434	7/16"-14 x 1-1/4"	Round	31/32"	with Lock Nuts	25
5243	7/16"-14 x 1-1/2"	Round	31/32"	without Nuts	25
3100	7/16"-14 x 1-1/2"	Round	31/32"	with Hex Nuts	10
3435	7/16"-14 x 1-1/2"	Round	31/32"	with Lock Nuts	25
23495	1/2"-13 x 1-1/2"	Round	1/3/32"	without Nuts	5
3102	1/2"-13 x 1-1/2"	Round	1-3/32"	with Hex Nuts	10
3438	1/2"-13 x 1-1/2"	Round	1-3/32"	with Lock Nuts	25

* Not Stainless Steel Cap - Chrome Plated

WARNING: Reproductive Harm & Cancer www.P65Warnings.ca.gov

BUMPER BOLTS



15545

Zinc

1/4"-20 x 3/4"

Stainless Steel Cap without Nuts

Head Diameter: 5/8"

Shoulder Length: 9/64"

UNIT PACKAGE: 25



9853

(376337-S100)

Zinc

5/16"-18 x 3/4"

Stainless Steel Cap without Nuts

Head Diameter: 3/4"

Shoulder Length: 3/16"

Ford

UNIT PACKAGE: 25

9854

Same as 9853 except with Hex Nuts

UNIT PACKAGE: 25

9855

Same as 9853 except with Lock Nuts

UNIT PACKAGE: 25



11614

(9433489)

Zinc

3/8"-16 x 1"

Stainless Steel Capped Pan Head w/o Nuts

Head Diameter: 7/8"

Shoulder Length: 3/32"

GM

UNIT PACKAGE: 25

11615

Same as 11614 except with Hex Nuts

UNIT PACKAGE: 25

BUMPER BOLTS



10655
(6026723)
Zinc

3/8"-16 x 1"

Stainless Steel Capped Pan Head without Nuts

Head Diameter: 7/8"
Shoulder Length: 3/32"
Chrysler

UNIT PACKAGE: 25

10656

Same as 10655 except
with Hex Nuts
UNIT PACKAGE: 25

10657

Same as 10655 except
with Lock Nuts
UNIT PACKAGE: 25



8623
Zinc

7/16"-14 x 1"

Stainless Steel Capped Pan Head without Nuts

Head Diameter: 29/32"
Shoulder Length: 5/32"
GM

UNIT PACKAGE: 25

8624

Same as 8623 except
with Hex Nuts
UNIT PACKAGE: 25

8625

Same as 8623 except
with Lock Nuts
UNIT PACKAGE: 25



9354
(9786454)
Zinc

7/16"-14 x 1-3/8"

Stainless Steel Capped Pan Head without Nuts

Head Diameter: 29/32"
Shoulder Length: 5/32"
GM

UNIT PACKAGE: 25

9355

Same as 9354 except
with Hex Nuts
UNIT PACKAGE: 25

9356

Same as 9354 except
with Lock Nuts
UNIT PACKAGE: 25

11770
(490067)
Zinc



7/16"-14 x 1-1/2"

Uncapped Round Head without Nuts

Head Diameter: 15/16"
Shoulder Length: 3/16"
GM

UNIT PACKAGE: 25

11771

Same as 11770 except with Hex Nuts

UNIT PACKAGE: 25

16986
(14003784)
Zinc



M8-1.25 x 25mm

Stainless Steel Capped Pan Head without Nuts

Head Diameter: 19mm
Shoulder Length: 3mm
GM

UNIT PACKAGE: 25



23497
20130258

Rubber with Brass

M6-1.0

Well Nut, Washer & Screw Anchor Kit

Hole Size: 12.7mm
Head Diameter: 20mm
Panel Range: 0.38 - 2.39mm
GM Wagons 1979 - On
& General Purpose

UNIT PACKAGE: 10



Specification Chart



Auveco Part No.	Size	Length	Hex Size	Washer Head O.D.	Type	Point Type	Finish	Unit Pkg.	Page No.
2209 ⚠	#8-32	5/16"		11/32"	Phillips Truss Head	C	Chrome	100	39
24177	1/4"-20	3/4"		3/4"	Hex Head Sems	Dog Pt	Blk Phos	50	39
10823	1/4"-20	7/8"	7/16"	3/4"	Hex Head Sems*	Dog Pt	Blk Phos	50	39
13231	1/4"-20	7/8"	3/8"	5/8"	Hex Washer Head with Sems Nylon Washer	CA	Phosphate Organic	25	39
13232	1/4"-20	7/8"	3/8"	5/8"	Hex Washer Head with Sems Nylon Washer & Expansion Nut	CA	Phosphate Organic	25	39
17034 ⚠	1/4"-20	7/8"	7/16"	3/4"	Hex Head Sems	Dog Point	Yellow Zinc Dichromate	50	39
9757	1/4"-20	1"	3/8"	1"	Hex Head Sems	C	Phosphate	100	39
9480	1/4"-20	1"	7/16"	5/8"	Hex Head Sems	Dog Pt	Phosphate	50	39
24168	1/4"-20	1-1/8"		3/4"	Hex Head Sems	Dog Pt	TrvInt Yllw Zinc	50	
14976	1/4"-20	1-1/4"	3/8"	5/8"	Hex Washer Head with Nylon Washer	CA	Stainless Steel Bright Plated	25	39
14977	1/4"-20	1-1/4"	3/8"	5/8"	Hex Washer Head with Nylon Washer & Expansion Nut	CA	Stainless Steel Bright Plated	10	40
24174	1/4"-20	1-13/16"		3/4"	Hex Head Sems	Dog Pt	Blk Phos	50	40
2688	5/16"-24	1"	1/2"	13/16"	Hex Washer Head Spin Lock	Dog Pt	Black Phos.	50	36
10084	5/16"-18	3/4"	1/2"	21/32"	Hex Washer Head	CA	Blk Phos	100	40
3615	5/16"-18	3/4"	1/2"	13/16"	Hex Washer Head Spin Lock	Dog Pt	Blk Phos	100	36
10362	5/16"-18	13/16"	1/2"	41/64"	Hex Washer Head	CA	Blk Phos	50	40
15792	5/16"-18	7/8"	1/2"	3/4"	Hex Head Sems	CA	Phos. Organic	50	40
15783	5/16"-18	7/8"	1/2"	3/4"	Hex Head Sems	CA	Phosphate	50	40
23662	5/16"-18	15/16"		7/8"	Hex Head Sems	Dog Pt	Blk Phos	50	40
23666	5/16"-18	15/16"		7/8"	Hex Head Sems	Dog Pt	Trivalent Yellow Zinc	40	
23692	5/16"-18	1"	1/2"	5/8"	Hex Washer Head	CA	Blk Phos	50	40
5711	5/16"-18	1"	1/2"	13/16"	Hex Washer Head Spin Lock	Dog Pt.	Blk Phos	50	36
9756	5/16"-18	1"	1/2"	7/8"	Hex Head Sems	C	Phosphate	100	40
11320	5/16"-18	1"	1/2"	7/8"	Hex Head Sems	CA	Phosphate	25	40
17035 ⚠	5/16"-18	1-1/16"	1/2"	7/8"	Hex Head Sems	Dog Pt	Yellow Zinc Dichromate	25	41
5713	5/16"-18	1-1/4"	1/2"	13/16"	Hex Washer Head Spin Lock	Dog Pt	Blk Phos	50	36
8847	5/16"-18	1-1/4"	1/2"	7/8"	Hex Head Sems	Dog Pt	Blk Phos	50	41
11061	5/16"-18	1-1/4"	1/2"	21/32"	Hex Washer Head	Pinch	Plain	50	41
23663	5/16"-18	1-3/16"		7/8"	Hex Head Sems	Dog Pt	Blk Phos	50	41
23665	5/16"-18	1-3/16"		7/8"	Hex Head Sems	Dog Pt	TrvInt Yllw Zinc	50	41
12009	5/16"-18	1-1/2"	1/2"	21/32"	Hex Washer Head	CA	Phos & Oil	50	41
11109	3/8"-16	1"	9/16"	1"	Hex Head Sems	CA	Phosphate	25	41
23664	3/8"-16	1-3/16"		1"	Hex Head Sems	Dog Pt	Blk Phos	50	41
11110	3/8"-16	1-3/8"	9/16"	1-1/8"	Hex Head Sems	CA	Phosphate	25	41

⚠ **WARNING:** Reproductive Harm & Cancer
www.P65Warnings.ca.gov

METRIC BODY BOLT CHART APPEARS ON PAGES 80 & 81

BODY BOLTS



2209
 Chrome
 #8-32 x 5/16"
Phillips Truss Head
UNIT PACKAGE: 100

⚠ WARNING: Reproductive Harm & Cancer
www.P65Warnings.ca.gov



24177
 (57472S2)
 Black Phosphate
 1/4"-20 x 3/4"
Hex Head Sems® with Dog Point
 Washer Diameter: 3/4"
 Across Flats: 7/16"
UNIT PACKAGE: 50



10823
 Black Phosphate
 1/4"-20 x 7/8"
Hex Head Sems® with Dog Point
 Washer O.D.: 3/4"
 Hex: 7/16"
UNIT PACKAGE: 50



17034
 (57030-S36)
 Yellow Zinc Dichromate
 1/4"-20 x 7/8"
Hex Head Sems® with Dog Point
 Washer O.D.: 3/4"
 Hex: 7/16"
 Ford
UNIT PACKAGE: 50



13231
 (14007510)
 Phos. Organic
 1/4"-20 x 7/8"
Hex Washer Head with Sems® Nylon Washer
 Washer O.D.: 5/8"
 Hex: 3/8"
 Truck Mirror Mounting Screw
 GM
UNIT PACKAGE: 25



13232
 (14007510, 367292)
 Phosphate Organic Screw
 Zinc with Sealer Expansion Nut
 1/4"-20 x 7/8"
Hex Washer Head with Sems® Nylon Washer
 Washer O.D.: 5/8"
 Hex: 3/8"
 Truck Mirror Mounting Screw
 & Expansion Nut
 GM, Chrysler
UNIT PACKAGE: 25 Sets



9480
 (6025329)
 Phosphate
 1/4"-20 x 1"
Hex Head Sems® with Dog Point
 Washer O.D.: 5/8"
 Hex: 7/16"
 Chrysler
UNIT PACKAGE: 50



9757
 Phosphate
 1/4"-20 x 1"
Hex Head Sems®
 Washer O.D.: 1"
 Hex: 3/8"
 GM, Ford
UNIT PACKAGE: 100

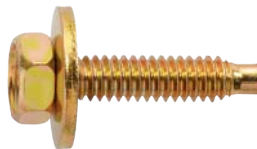

24168
 (57032S36)
 Trivalent Yellow Zinc
 1/4"-20 x 1-1/8"
Hex Head Sems® with Dog Point
 Washer Diameter: 3/4"
 Across Flats: 7/16"
UNIT PACKAGE: 100



14976
 (367291, 474821, 14007511)
 400 Series Stainless Steel
 Bright Plated
 1/4"-20 x 1-1/4"
Hex Washer Head with Nylon Washer
 Washer O.D.: 5/8"
 Hex: 3/8"
 Truck Mirror Mounting Screw
 GM, Chrysler
UNIT PACKAGE: 25



14977

(367291, 367292,
474821, 14007511)

400 Series Stainless

Steel - Bright Plated Zinc with Sealer Expansion Nut

1/4"-20 x 1-1/4"

Hex Washer Head with Nylon Washer

Washer O.D.: 5/8"

Hex: 3/8"

Truck Mirror Mounting Screw & Expansion Nut
GM, Chrysler

UNIT PACKAGE: 10 Sets



24174

Black Phosphate

1/4"-20 x 1-3/16"

Hex Head Sems® with Dog Point

Washer Diameter: 3/4"

Across Flats: 7/16"

UNIT PACKAGE: 50



10084

Black Phosphate

5/16"-18 x 3/4"

Hex Washer Head

Washer Head O.D.: 21/32"

Hex: 1/2"

GM

UNIT PACKAGE: 100



10362

Black Phosphate

5/16"-18 x 13/16"

Hex Washer Head

Washer Head O.D.: 41/64"

Hex: 1/2"

GM

UNIT PACKAGE: 50



15792

(1598757, 15686047)
Phosphate Organic

5/16"-18 x 7/8"

Indented Hex Head Sems®

Washer O.D.: 3/4"

Hex: 1/2"

GM

UNIT PACKAGE: 50



15783

(3846202)

Phosphate

5/16"-18 x 7/8"

Indented Hex Head Sems®

Washer O.D.: 3/4"

Hex: 1/2"

GM

UNIT PACKAGE: 50



23662

(57039S2)

Black Phosphate

5/16"-18 x 15/16"

Hex Head Sems® with Dog Point

Washer Diameter: 7/8"

Across Flats: 1/2"

UNIT PACKAGE: 50



23666

(384930S36)

Trivalent Yellow Zinc

5/16"-18 x 15/16"

Hex Head Sems® with Dog Point

Washer Diameter: 7/8"

Across Flats: 1/2"

UNIT PACKAGE: 50



9756

Phosphate

5/16"-18 x 1"

Hex Head Sems®

Washer O.D.: 7/8"

Hex: 1/2"

GM, Ford

UNIT PACKAGE: 100



11320

Phosphate

5/16"-18 x 1"

Hex Head Sems®

Washer O.D.: 7/8"

Hex: 1/2"

GM, Ford

UNIT PACKAGE: 25

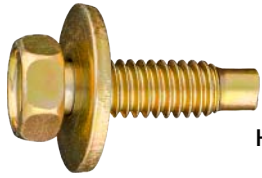

17035
(384931-S36)
Yellow Zinc Dichromate
5/16"-18 x 1-1/16"
Hex Head Sems® with Dog Point
Washer O.D.: 7/8"
Hex: 1/2"
Ford

UNIT PACKAGE: 25



8847
(380575-S2)
Black Phosphate
5/16"-18 x 1-1/4"
Hex Head Sems® with Dog Point
Washer O.D.: 7/8"
Hex: 1/2"
Ford

UNIT PACKAGE: 50



11061
Plain
5/16"-18 x 1-1/4"
Hex Washer Head with Pinch Point
Washer Head O.D.: 21/32"
Hex: 1/2"

UNIT PACKAGE: 50



23663
(57041S2)
Black Phosphate
5/16"-18 x 1-3/16"
Hex Head Sems® with Dog Point
Washer Diameter: 7/8"
Across Flats: 1/2"

UNIT PACKAGE: 50

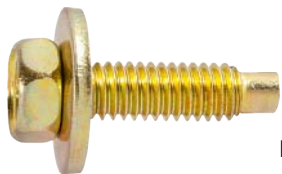

23665
(384932S36 ; 57041S36)
Trivalent Yellow Zinc
5/16"-18 x 1-3/16"
Hex Head Sems® with Dog Point
Washer Diameter: 7/8"
Across Flats: 1/2"

UNIT PACKAGE: 50



12009
Phosphate & Oil
5/16"-18 x 1-1/2"
Hex Washer Head
Washer Head O.D.: 21/32"
Hex: 1/2"
GM

UNIT PACKAGE: 50



11109
(3986997, 14011722)
Phosphate
3/8"-16 x 1"
Hex Head Sems®
Washer O.D.: 1"
Hex: 9/16"
GM

UNIT PACKAGE: 25



23664
(57048S2)
Black Phosphate
3/8"-16 x 1-3/16"
Hex Head Sems® with Dog Point
Washer Diameter: 1"
Across Flats: 9/16"

UNIT PACKAGE: 25



11110
(407217, 1564180)
Phosphate
3/8"-16 x 1-3/8"
Hex Head Sems®
Washer O.D.: 1-1/8"
Hex: 9/16"
Hood Hinge to Sheet Metal Bolt
GM

UNIT PACKAGE: 25

Special Tapping Screw Specification Chart



Auveco Part No.	Size	Length	Hex Size	Washer/ Head O.D.	Type	Point Type	Finish	Unit Pkg.	Page No.
9877	#4-24	3/8"		7/32"	Phillips Flat Head	AB	Zinc	100	46
23588	#4-24	5/8"		7/32"	Wafer Head Screw-In Stud	B	Zinc	100	46
23597	#8-18	3/8"			Phillips Pan Head	AB	Zinc	100	46
10642	#8	3/8"		3/8"	Phillips Oval Washer Head	AB	Zinc	100	46
24171	#8-18	3/8"			Phillips Attaching Screw		Zinc	100	46
16997	#8	3/8"		3/8"	Phillips Oval Washer Head	AB	Black E-Coat	100	46
23799	#8	3/8"		9/32"	Phillips Washer Head	Drill	Chrome	100	47
9863	#8	3/8"		9/32"	Phillips Round Washer Head	AB	Zinc	100	47
13707	#8	3/8"		13/32"	Phillips Flat Top Washer Head	AB	Zinc	100	47
8944	#8	3/8"		7/16"	Phillips Washer Head	AB	Chrome	100	47
12062	M4.2 (#8)	10mm (13/32")		11mm (7/16")	Phillips Washer Head, Pozi-Drive	AB	Black Oxide	100	47
2805	#8	7/16"		3/8"	Phillips Washer Head	AB	Zinc	100	47
15037	#8	7/16"		5/16"	Phillips Washer Head	AB	Chrome	100	47
1826	#8	7/16"		13/32"	Phillips Truss Head	AB	Chrome	100	47
23610	#8	7/16"		3/8"	Phillips Washer Head	#2 Drill	Chrome	50	47
24178	#8	1/2"			Phillips Washer Head	#2 Drill	Chrome	100	47
15941	M4.2 (#8)	12mm (15/32")		9.5mm (3/8")	Phillips Truss Head	AB	Black Oxide	10	47
12739	M4.2 (#8)	12mm (15/32")		10mm (25/64")	Phillips Washer Head, Pozi-Drive	AB	Chrome	100	47
23909	M4.2-1.41	12mm		11mm	Phillips Washer Head	A/AB	Black	100	48
23893	#8	1/2"		13/32"	Phillips Washer Head	#2 Drill	Black	100	48
12213	#8	1/2"		13/32"	Phillips Flat Top Washer Head	AB	Black E-Coat	100	48
13025	#8	1/2"		31/64"	Phillips Washer Head	AB	Phosphate	100	48
20375	#8	1/2"		1/2"	Phillips Round Washer Head	AB	Black Phos.	100	48
15172	#8	1/2"		13/32"	Phillips Washer Head	Teks®	Zinc	100	48
15171	#8	1/2"		23/64"	Phillips Low Profile Round Wash Head	Teks	Zinc	100	48
12095	#8	1/2"		7/16"	Phillips Washer Head	Teks	Zinc	50	48
15774	#8	1/2"		7/16"	Phillips Washer Head	Teks	Black Phos.	50	48
16478	#8	1/2"		13/32"	Phillips Flat Top Round Washer Head	Teks	Black Zinc	100	48
24175	#8	1/2"			Phillips Washer Head	#2 Drill	Chrome	100	48
12059	M4.2 (#8)	13mm (33/64")		11mm (7/16")	Phillips Washer Head	AB	Zinc	100	48
12061	M4.2 (#8)	13mm (33/64")		8.5mm (11/32")	Phillips Round Washer Head, Pozi-Drive	AB	Black Oxide	100	48
23794	M4.2-1.41	13mm		8mm	Phillips Pozi Washer	A/AB	Chrome	100	48
22550	M4.2	20mm		11mm	Round Washer Head Pozi-Drive Tapping Screw		Black Zinc	25	48
13712	M4.2 (#8)	13mm (33/64")		11mm (7/16")	Phillips Washer Head	AB	Black Zinc	50	49
12740	M4.2 (#8)	13mm (33/64")	7mm	12mm (15/32")	Hex Head Sems®	AB	Phosphate	100	49
121122	M4.2 (#8)	14mm (9/16")		11mm (7/16")	Phillips Washer Head, Pozi-Drive	Teks	Chrome	50	49
23833	M4.2-0.79	15mm		11mm	Phillips Washer Head	A/AB	Black	100	49
2806	#8	5/8"		13/32"	Phillips Round Washer Head	AB	Chrome	100	49
13711	#8	5/8"		31/64"	Phillips Washer Head	AB	Phosphate	100	49
23719	#8	5/8"		1/2"	Phillips Flat Top Washer Head	B	Black	100	49
23841	M4.2-1.41	15mm		12mm	Phillips Pan Head Sems	A/AB	Black	100	49
18817	M4.2 (#8)	16mm (5/8")		11mm (7/16")	Phillips Round Washer Head, Pozi-Drive	Teks	Black Zinc	100	49
22945	M4.2	16mm		11mm	Torx Button Head Tapping Screw	BR		50	49
16720	M4.2 (#8)	16mm (5/8")		9.5mm (3/8")	Phillips Truss Head	AB	Black Oxide	100	50
23792	M4.2-1.41	16mm			Phillips Pan Head	#2 Drill	Black	100	100
12741	M4.2 (#8)	16mm (5/8")	7mm	12mm (15/32")	Hex Head Sems	AB	Phosphate	100	50
18261	M4.2 (#8)	16mm (5/8")	7mm	12mm (15/32")	Hex Washer Head Sems	Teks	Phosphate	50	50
23795	#8	5/8"	9/32"		Hex Washer Head Sems	#2 Drill	Black	100	50
23869	M4.2-1.41	18mm		12mm	Hex Head Sems	B	Black	50	50
23809	M4.2-1.41	17mm		9mm	Hex Washer Head	A/AB	Black	100	50

(Continued on next page)

Sec. 04

Special Tapping Screw Specification Chart



Auveco Part No.	Size	Length	Hex Size	Washer/ Head O.D.	Type	Point Type	Finish	Unit Pkg.	Page No
24465	M4.2	19mm		11mm	Phillips Flat Top Washer Head	Drill		100	50
23837	#8	3/4"			Phillips Oval Head Sems	A/AB	Black	100	50
13026	#8	3/4"		31/64"	Phillips Washer Head	AB	Phosphate	100	50
17460	#8	3/4"		7/16"	Phillips Round Washer Head	Teks®	Zinc	50	50
22537	M4.8	16mm	7mm	12.5mm	Hex Washer Head Screw		Black Zinc	50	50
17650	#8	3/4"		7/16"	Phillips Round Washer Head	Teks	Phosphate	50	51
22549	M4.2	19mm	7mm	12.5mm	Hex Washer Head Tapping Screw		Zinc	25	51
12060	M4.2 (#8)	20mm (25/32")		11mm (7/16")	Phillips Washer Head	AB	Black Oxide	100	51
12097	M4.2 (#8)	20mm (25/32")		12mm (15/32")	Phillips Pan Head Sems®	AB	Chrome	50	51
12738	M4.2 (#8)	20mm (25/32")	7mm	12mm (15/32")	Hex Washer Head Sems	AB	Phosphate	50	51
12742	M4.2 (#8)	20mm (25/32")	7mm	12mm (15/32")	Hex Head Sems	AB	Phosphate	100	51
15373	M4.2 (#8)	20mm (25/32")	7mm	16mm (5/8")	Hex Head Sems	AB	Phosphate	50	51
20271	M4.2 (#8)	20mm (25/32")		16mm (5/8")	Phillips Pan Head Sems	AB	Phosphate	50	52
24183	M4.2-1.41	20mm		17mm	Hex Head Sems	A/AB	Black Phos.	50	
20476	M4.2 (#8)	20mm (25/32")	7mm	17mm (11/16")	Hex Washer Head Sems	Teks	Phosphate	50	52
19278	M4.2 (#8)	20mm (25/32")	7mm	20mm (25/32")	Hex Head Sems	AB	Black Phos.	50	52
15775	M4.2 (#8)	20mm (25/32")	7mm	12mm (15/32")	Hex Head Sems	Teks	Phosphate	50	52
22070	M4.2 (#8)	20mm (25/32")		17mm (11/16")	Torx® Pan Head Sems	Dog Point	Black Zinc	50	52
22946	M4.2	20mm	7mm	17mm	Hex Head Sems	BR	Black Zinc	25	52
22104	M4.2	22mm	5.5mm	16mm	Hex Head Sems	AB	Black Zinc	50	52
23867	#8	1"			Phillips Oval Head Sems	A/AB	Chrome	50	52
18296	#8	1"		7/16"	Phillips Round Washer Head	Teks	Zinc	50	53
19006	M4.2 (#8)	25mm (1")		11mm (7/16")	Pozi-Drive Round Washer Head	Teks	Phosphate	100	53
20382	M4.2 (#8)	25mm (1")	T-15 Drive	12mm (15/32")	Torx® Pan Head Sems	AB	Black Zinc	50	53
22081	M4.2	25mm		17mm	Pozi-Drive Round Washer Head Sems	AB	Black Zinc	50	53
20376	#8	1"		1/2"	Phillips Round Washer Head	AB	Black Phos.	100	53
18336	M4.2 (#8)	25mm (1")	7mm	12mm (15/32")	Hex Head Sems	AB	Black Phos.	100	53
25101	M4.2-1.41	25mm	7mm	17mm	Bumper, Fender Apron & Moulding Hex Head Sems®		Zinc	50	53
22724	M4.2	25mm	7mm	12.5mm	Indented Hex Flang Head Sems		Black Zinc	50	53
19653	M4.2 (#8)	30mm (1-3/16")	7mm	17mm (11/16")	Hex Head Sems	AB	Black Phos.	15	53
25150	M4.2	34mm	7mm	14.5mm	Hex Washer Head Sems	Hex	Black Zinc & Nickel	25	54
18460	#8	1-1/4"		3/8"	Phillips Oval Head Sems Flush Washer	Teks	Phosphate	50	54
19778	#8	1-1/4"		7/16"	Phillips Round Washer Head	Teks	Zinc	50	54
24132	#8	1-1/2"			Phillips Pan Head	#2 Drill	Black	100	54
2178	#10	3/8"		31/64"	Phillips Round Washer Head	AB	Zinc	100	54
2028	#10	1/2"		11/32"	Phillips Round Head	AB	Zinc	100	54
13027	#10	1/2"		15/32"	Phillips Flat Washer Head	AB	Zinc	100	54
15827	#10	1/2"		15/32"	Phillips Flat Washer Head	AB	Phosphate	100	54
23581	#10-16	1/2"		1/2"	Boot Well & Weatherstrip Rails	A	Black Zinc	100	54
18340	M4.8 (#10)	15mm (19/32")		14mm (9/16")	Phillips Truss Head	AB	Black Phos.	50	54
20364	#10	5/8"		7/16"	Phillips Washer Head	Teks	Zinc	100	55
23838	#10	5/8"			Phillips Oval Head Sems	A/AB	Black	100	55

(Continued on next page)

Special Tapping Screw Specification Chart

Sec. 04



Washer/ Auveco Part No.	Size	Length	Hex Size	Head O.D.	Type	Point Type	Finish	Unit Pkg.	Page No.
23835	#10	5/8"			Phillips Oval Head Sems®	A/AB	Chrome	100	55
17459	M4.8 (#10)	16mm (5/8")		11mm (7/16")	Phillips Truss Head	AB	Black Oxide	100	55
24176	M4.8-1.61	16mm		15mm	Hex Head Sems	A/AB	Black Phos.	100	55
23847	M4.8-1.61	16mm		16mm	Hex Head Sems	A/AB	Zinc	50	55
22030	M4.8 (#10)	16mm (5/8")	8mm	18mm	Hex Head Sems	AB	Black Zinc	50	55
22110	M4.8	18mm	T-25 Drive	15mm	Torx Truss Head	AB	Black Zinc	25	55
20259	M4.8 (#10)	19mm (3/4")		16mm (5/8")	Phillips Truss Head Sems®	AB	Black E Coat	25	55
13709	#10	3/4"		15/32"	Phillips Flat Top Washer Head	AB	Zinc	50	55
23706	#8	3/4"			Torx Oval Head	A/AB	Chrome	50	
19240	#10	3/4"		1/2"	Phillips Flat Top Round Washer Head	AB	Black E-Coat	100	56
24172	M4.8-1.61	19mm		15mm	Hex Head Sems	A/AB	Black Phos.	100	56
16589	M4.8 (#10)	19mm (3/4")	8mm	15mm (19/32")	Hex Head Sems	AB	Yellow Zinc Dichromate	50	56
21774	M4.8 (#10)	20mm (25/32")	8mm	26mm	Hex Head Sems	AB	Black E-Coat	25	56
25409	M6-1.81	25mm		16mm	Phillips Truss Head	#3 Phillips	Black	25	56
23836	#10	1"			Phillips Oval Head Sems	A/AB	Chrome	100	56
21865	M4.8 (#10)	32mm (1-1/4")	8mm	19mm (3/4")	Hex Head Sems	AB	Phosphate	50	56
19237	#10	1-1/32"		9/16"	Nylon Phillips Pan Head	AB	Black Nylon	50	56
21746	M5	11mm		11mm	Phillips Truss Head	AB	Black Oxide	50	56
21747	M5	11mm		12mm	Phillips Round Washer Head	AB	Black Oxide	50	56
22294	M5-1.81	16mm	8mm	16mm	Phillips Hex Head Sems		Black Phos.	25	56
22203	M5-1.81	20mm		13mm	Phillips Flat Head		Black Phos.	100	57
25395	M5-2.12	15mm	8mm	18mm	Hex Head Sems	B	Zinc	25	57
25203	M5-2.12	16mm		11mm	Round Washer Head	T20	Zinc	50	57
25394	M5-2.12 (#2)	18mm		16mm	Phillips Truss Head	AB	Black Zinc	25	57
25397	M5-2.12	18mm	8mm	22mm	Hex Head Sems		Black Zinc	25	57
22111	M5-2.12 (#12)	19mm (3/4")	T-25 Drive	14mm (9/16")	Torx® Truss Head	AB	Black Zinc	25	57
20455	M5-2.12 (#12)	20mm (25/32")		14mm (9/16")	Phillips Truss Head	AB	Black Phos.	50	57
25202	M5-2.12	20mm	8mm	22mm	Hex Head Sems		Black	25	58
25238	M5-2.12	22mm	10mm	18mm	Phillips Hex Head Sems	#3 Phillips	Zinc	50	58
22348	M5-2.2	20mm		20mm	Torx Pan Head Sems		Black	15	57
21841	M5.2 (#12)	20mm (25/32")	8mm	12mm (1/2")	Phillips Hex Head Sems	AB	Black E-Coat	25	58
21839	M5.2 (#12)	21mm (13/16")	10mm	14mm (9/16")	Phillips Hex Head Sems	AB	Zinc	25	58
25317	M5.2-2.12	18mm	8mm	16mm	Hex Head Sems			25	58
25225	M5.48-1.81	18mm	8mm	15mm	Hex Head Sems		Black E-Coat	50	58
21541	M5.5 (#12)	20mm (25/32")	T-20 Drive	15mm (19/32")	Torx Truss Head	AB	Black Zinc	25	58
22292	M5.5-1.81 (#12)	16mm (5/8")		13mm	Phillips Truss Head		Black Phos.	25	58
17461	M5.5-1.81 (#12)	18mm (45/64")	8mm	15mm (19/32")	Hex Head Sems	AB	Yellow Zinc Dichromate	50	58
25258	M6-1.81 x 15		10mm	18mm	Hex Head Sems		Zinc	25	58
21744	M6-1.81	20mm	10mm	13mm	Phillips Hex Head Sems	AB	Black E-Coat	25	58
19170	M6.3 (#14)	16mm (5/8")		15mm (19/32")	Phillips Truss Head	AB	Black Phos.	50	59
15776	M6.3 (#14)	16mm (5/8")	8mm	16mm (5/8")	Hex Head Sems	AB	Phosphate	50	59

(Continued on next page)



Auveco Part No.	Size	Length	Hex Size	Washer/ Head O.D.	Type	Point Type	Finish	Unit Pkg.	Page No.
12057	M6.3 (#14)	16mm (5/8")	10mm	17mm (11/16")	Hex Head Sems	AB	Phosphate	50	59
22106	M6.3	18mm	10mm	14mm	Phillips Hex Head Sems	AB	Zinc	25	59
13021	#14	3/4"	3/8"	1/2"	Hex Washer Head	AB	Phosphate	50	59
23864	#14	3/4"		1/2"	Phillips Hex Head Washer	A/AB	Black	50	59
23850	#14	3/4"		5/8"	Hex Serrated Washer Head	Pierce	Black	50	59
23758	1/4"	3/4"			Hex Washer Head	A/AB	Black	100	59
13019	M6.3 (#14)	19mm (3/4")	8mm	11.5mm (29/64")	Hex Washer Head	AB	Phosphate	50	59
20556	M6.3 (#14)	20mm (25/32")	10mm	16mm (5/8")	Phillips Hex Head Sems	AB	Black Zinc	50	60
12351	M6.3 (#14)	20mm (25/32")	10mm	17mm (11/16")	Hex Washer Head Sems	AB	Black Phosphate	50	60
16828	M6.3 (#14)	20mm (25/32")	10mm	18mm (45/64")	Hex Head Sems	AB	Yellow Zinc Dichromate	25	60
25226	M6.3-1.81	20mm	10mm	18mm	Hex Head Sems		Black E-Coat	25	60
20557	M6.3 (#14)	20mm (25/32")	10mm	20mm (25/32")	Phillips Hex Head Sems	AB	Black Zinc	50	60
20557	M6.3-1.81	20mm		20mm	Phillips Hex Head Sems	A/AB	Black Zinc	50	60
18934	#14	7/8"	3/8"	13/16"	Hex Washer Head	AB	Zinc Organic	25	60
23695	M6.3-1.81	22mm		24mm	Hex Head Sems	A/AB	Black Zinc	50	60
21838	M6.3 (#14)	24mm (15/16")	10mm	16mm (5/8")	Phillips Hex Head Sems®	AB	Zinc	25	60
12339	M6.3 (#14)	25mm (1")	10mm	17mm (11/16")	Hex Head Sems	AB	Phosphate	50	60
23803	#14	1"		3/4"	Hex Head Sems	A/AB	Zinc	100	60
12354	M6.3 (#14)	30mm (1-3/16")	10mm	17mm (11/16")	Hex Head Sems	AB	Phosphate	50	61
12068	M6.3 (#14)	30mm (1-3/16")	10mm	24mm (15/16")	Hex Head Sems	AB	Phosphate	50	61
25237	M6.3	16mm	10mm	18mm	Phillips Hex Head Sems	#3 Phillips	Black E-Coat	50	61
25078	M6.3	18mm	10mm	16mm	Phillips Indented Hex Head Sems	#3 Phillips	Black Dacromet	50	61
22295	M6.5-1.81	18mm		16mm	Phillips Truss Head		Black Phos.	25	61
22296	M6.5-1.81	25mm		16mm	Phillips Truss Head		Black Phos.	25	62
21837	M6.5	19mm	10mm	20mm	Phillips Hex Head Sems	AB	Black E-Coat	25	62
19417	M7.5	35mm (1-3/8")	#3 Sq. Drive	22mm (7/8")	Nylon Square Drive Truss Head	AB	Black Nylon	15	62
12350	M8 (5/16"-12)	20mm (25/32")	13mm	16mm (5/8")	Hex Washer Head	AB	Phosphate	25	62
10364	5/16"-12	7/8"	1/2"	21/32"	Hex Washer Head	AB	Black Oxide	100	62
10714	5/16"-12	1"	1/2"	21/32"	Hex Washer Head	AB	Phosphate	50	62
21517	M9.5	46mm (1-13/16")	#3 Sq. Drive	22mm (7/8")	Nylon Square Drive Truss Head	AB	Black Nylon	25	62
20970	M14	34mm (1-11/32")	#3 Sq. Drive	22mm (7/8")	Nylon Square Drive Truss Head	AB	Black Nylon	25	62



Round Washer Head Thread Forming Screws

Optimize thread forming in plastic materials

- Minimizes stress
- Reduces boss size
- Increases fastening integrity
- Increased joint life
- Improved vibrational safety
- Improved dynamic safety by new shear area
- Higher & better clamp load at smaller contact pressure
- Increased flank engagement

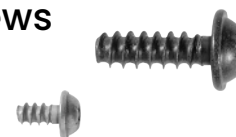

Auveco Part No.	Size	Length	Drive Size	Washer/ Head O.D.	OEM #	Point Type	Finish	Unit Pkg.
25204	M4-1.75	14mm	T-20	8.9mm	46637659479		Phosphate	50
25007	M3-1.12	6mm	T-10	6.3mm	11570768	B	Zinc	15
25008	M3-1.12	10mm	TS-20	8.7mm	11547683	B	Black	25
25009	M3-1.12	12mm	T-10	6mm	11561265 , W506923S450B	B	Black	25
25010	M4-1.46	8mm	T-10	8.7mm	W506941-S450B 11546966	B	Black	25
25011	M4-1.46	10mm	T-20	8.7mm	6510170AA, 11546967 W506942S450B	B	Black	50
25012	M4-1.46	12mm	T-20	8.7mm	6510329AA, 11546968 W506943S450B	B	Black	25
25013	M4-1.46	14mm	T-20	8.7mm	6510330AA, 11546969, W506944S450B	B	Black	50
25014	M4-1.46	16mm	T-20	8.7mm	6510331AA, 11546970, W506945S450B	B	Black	25
25015	M5-1.80	16mm	T-25	10.7mm	6510672AA, 11611225 W506964S450B		Black	25

SPECIAL TAPPING SCREWS



9877

Zinc

#4-24 x 3/8"

Special Phillips Flat Head

Head Diameter: 7/32"

Use to replace Welded Studs for Moulding Clips

UNIT PACKAGE: 100



23588

Zinc

#4-24 x 5/8"

Phillip Wafer Head

Head Diameter: 7/32"

Point Type: B

Replaces weld-on stud
For attaching moulding clips to body
GM, Ford, Chrysler All Models

UNIT PACKAGE: 100



23597

Bright Zinc

#8-18 x 3/8"

Phillips Pan Head

Head Size: #6

Point Type: AB

For attaching windshield &
rear window reveal moulding
Chrysler 1962 & General Purpose

UNIT PACKAGE: 100



10642

(381671-S)

Zinc

#8 x 3/8"

Phillips Oval Washer Head

Washer Head Outer Diameter: 3/8"
Wheel Opening Mouldings
Ford

UNIT PACKAGE: 100



24171

Bright Zinc

#8-18 x 3/8"

Head Size: #9

Phillips Truss Head with Sealer

For attaching windshield & rear
window reveal moulding
Chrysler, Ford, GM & General Purpose

UNIT PACKAGE: 100



16997

Same as 10642 with Black E-Coat
(168 Hours Salt Spray)

#8 x 3/8"

Phillips Oval Washer Head

Washer Head Outer Diameter: 3/8"
Wheel Opening Mouldings

UNIT PACKAGE: 100



23799
(384474S47X)
Chrome

#8 x 3/8"
Phillips Washer Head
Washer Head Diameter: 9/32"
Point Type: Drill
Includes Bi-Wax

UNIT PACKAGE: 100

⚠ WARNING: Reproductive Harm & Cancer
www.P65Warnings.ca.gov



9863
Zinc

#8-18 x 3/8"
Phillips Round Washer Head
Head Diameter: 9/32"
Chrysler

UNIT PACKAGE: 100



13707
(9422246)
Zinc

#8 x 3/8"
Phillips Flat Top Washer Head
Washer Head Outer Diameter: 13/32"
Chrysler

UNIT PACKAGE: 100



8944
Chrome

#8-18 x 3/8"
Phillips Washer Head
Washer Head Outer Diameter: 7/16"
For attaching Chrome Floor Strips
Ford

UNIT PACKAGE: 100

⚠ WARNING: Reproductive Harm & Cancer
www.P65Warnings.ca.gov



12062
(11501903)
Black Oxide

M4.2-1.41 x 10mm (#8 x 13/32")
Phillips Washer Head Pozi-Drive
Washer Head Outer Diameter: 11mm (7/16")
GM

UNIT PACKAGE: 100



2805
Zinc

#8 x 7/16"
Phillips Washer Head
Washer Head Outer Diameter: 3/8"

UNIT PACKAGE: 100



15037
(588546)
Chrome

#8 x 7/16"
Phillips Washer Head
Washer Head Outer Diameter: 5/16"
Wheel Mouldings
GM

UNIT PACKAGE: 100

⚠ WARNING: Reproductive Harm & Cancer
www.P65Warnings.ca.gov



23610
(9616231)
Chrome

#8 x 7/16"
Phillips Washer Head with #2 Teks® Point
Washer Head Diameter: 3/8"

UNIT PACKAGE: 50

⚠ WARNING: Reproductive Harm & Cancer
www.P65Warnings.ca.gov



1826
Chrome

#8 x 7/16"
Phillips Truss Head
Head Diameter: 13/32"

UNIT PACKAGE: 100

⚠ WARNING: Reproductive Harm & Cancer
www.P65Warnings.ca.gov



24178
(388020S47)
Chrome

#8 x 1/2
Phillips Washer Head with Tek Point
Point Type: #2 Drill
UNIT PACKAGE: 100



15941
Black Oxide

M4.2-1.41 x 12mm (#8 x 15/32")
Phillips Truss Head
Head Diameter: 9.5mm (3/8")
Japanese Imports

UNIT PACKAGE: 10



12739
(11501794)
Chrome

M4.2-1.41 x 12mm (#8 x 15/32")
Phillips Washer Head Pozi-Drive
Washer Head Outer Diameter: 10mm (25/64")
GM

UNIT PACKAGE: 100

⚠ WARNING: Reproductive Harm & Cancer
www.P65Warnings.ca.gov



23909

Black Zinc

M4.2-1.41 x 12mm (#8 x 15/32")
Phillips Washer Head with Tek Point
 Washer Head Diameter: 11mm
 Point Type: A/AB

UNIT PACKAGE: 100



23893

Black Zinc

#8 x 1/2"

Phillips Washer Head
 Washer Head Diameter: 13/32"
 Point Type: #2 Drill

UNIT PACKAGE: 100



12213

(11503421, 11503636)

Black E-Coat

#8-18 x 1/2"

Phillips Flat Washer Head
 Washer Head Outer Diameter: 13/32"
 GM

UNIT PACKAGE: 100



13025

(56910-S2)

Phosphate

#8 x 1/2"

Phillips Washer Head
 Washer Head Outer Diameter: 31/64"
 Ford

UNIT PACKAGE: 100



20375

Black Phosphate

#8 x 1/2"

Phillips Round Washer Head
 Head Diameter: 1/2"

UNIT PACKAGE: 100



15172

Zinc

#8 x 1/2"

Phillips Washer Head with #2 Teks® Point
 Washer Head Outer Diameter: 13/32"

UNIT PACKAGE: 100



15171

Zinc

#8 x 1/2"

Phillips Low Profile Round Washer Head with #2 Teks® Point
 Washer Head Outer Diameter: 23/64"

UNIT PACKAGE: 100



12095

(1689827)

Zinc

#8 x 1/2"

Phillips Washer Head with Teks® Point
 Washer Head Outer Diameter: 7/16"
 Reveal Moulding to Panel
 GM

UNIT PACKAGE: 50



15774

(GM: 20423550)

(Ford: 381801-S2, 390017-S2)

Black Phosphate

#8 x 1/2"

Phillips Washer Head with Teks® Point
 Washer Head Outer Diameter: 7/16"
 GM & Ford

UNIT PACKAGE: 50



16478

(153297)

Black Zinc

#8-18 x 1/2"

Phillips Flat Top Round Washer Head
 Teks®

Washer Head Outer Diameter: 13/32"
 Chrysler

UNIT PACKAGE: 100



24175

Chrome Plated

#8-18 x 1/2"

Phillips Round Washer Head Screw
 Quarter Wheel House Moulding or Guard

UNIT PACKAGE: 100

WARNING: Reproductive Harm & Cancer
www.P65Warnings.ca.gov



12059

(11501883)

Zinc

M4.2-1.41 x 13mm (#8 x 33/64")

Phillips Oval Head Sems®
 Washer Head Outer Diameter: 11mm
 (7/16")
 GM

UNIT PACKAGE: 100



22550

(GM: 11609457)

Black Zinc

M4.2-1.41 x 20mm

Round Washer Head Pozi-Drive Tapping Screw

Head Diameter: 11mm

Tail Lamp Assembly

Buick Cascada, Enclave, Encore, Cadillac CTS, Chevrolet Avalanche, Camaro, Caprice, Corvette, Impala, Monte Carlo & Trax and Pontiac G6 2000 - On

UNIT PACKAGE: 25



12061

(11501896)

Black Oxide

M4.2-1.41 x 13mm (#8 x 33/64")

Phillips Round Washer Head Pozi-Drive
Washer Head Outer Diameter: 8.5mm (11/32")
GM

UNIT PACKAGE: 100



23794

(11502630)

Chrome

M4.2-1.41 x 13mm (#8 x 33/64")

Phillips Pozi-Drive Washer Head with Tek Point
Washer Head Diameter: 8mm
Point Type: A/AB

UNIT PACKAGE: 50

WARNING: Reproductive Harm & Cancer
www.P65Warnings.ca.gov



13712

(11505104)

Black Zinc

M4.2-1.41 x 13mm (#8 x 33/64")

Phillips Washer Head
Washer Head Outer Diameter: 11mm (7/16")
GM

UNIT PACKAGE: 50



12740

(11503394)

Phosphate

M4.2-1.41 x 13mm (#8 x 33/64")

Hex Head Sems®
Washer Outer Diameter: 12mm (15/32")
Hex: 7mm
GM

UNIT PACKAGE: 100



21122

Chrome

M4.2-1.41 x 14mm (#8 x 9/16")

Phillips Pozi-Drive Washer Head Tek's®
Washer Head Outer Diameter: 11mm (7/16")

UNIT PACKAGE: 50

WARNING: Reproductive Harm & Cancer
www.P65Warnings.ca.gov



23833

(10169998; 10155743; 10120517)

Black Zinc

M4.2-0.79 x 15mm

Phillips Serrated Washer Head with Tek Point
Washer Head Diameter: 11mm (7/16")
Point Type: A/AB

UNIT PACKAGE: 100



2806

Chrome

#8 x 5/8"

Phillips Round Washer Head
Washer Head Outer Diameter: 13/32"

UNIT PACKAGE: 100

WARNING: Reproductive Harm & Cancer
www.P65Warnings.ca.gov



13711

(56911-S2, 56929-S2)

Phosphate

#8 x 5/8"

Phillips Washer Head
Washer Head Outer Diameter: 31/64"
Ford

UNIT PACKAGE: 100



23719

Black Zinc

#8 x 5/8"

Phillips Flat Top Washer Head
Washer Outer Diameter: 1/2"
Point Type: B

UNIT PACKAGE: 100



23841

(11503499)

Black Zinc

M4.2-1.41 x 15mm

Phillips Pan Head Sems®
Washer Diameter: 12mm
Point Type: A/AB

UNIT PACKAGE: 100



18817

(1746408)

Black Zinc

M4.2-1.41 x 16mm (#8 x 41/64")

Phillips Round Washer Head with Serrations under the Head Pozi-Drive with Tek's® Point
Washer Head Outer Diameter: 11mm (7/16")
Moulding, Trim & General Purpose
GM

UNIT PACKAGE: 100



22945

(GM: 11611882)

Black

M4.2-1.41 x 16mm

Torx® Button Head Tapping Screw
Head Diameter: 11mm
T15 Drive
Point Type: BR

Tail Lamp & Interior Trim
Buick Cascada, Envision, Chevrolet Bolt EV, Camaro, Corvette, Equinox, Malibu, Silverado, Spark, GMC Sierra & Terrain 2016 - On
Buick Enclave, Cadillac CT6, Escalade, Chevrolet Colorado, Cruze & GMC Canyon 2018 - 2016

UNIT PACKAGE: 50



16720
Black Oxide
M4.2-1.41 x 16mm (#8 x 5/8")
Phillips Truss Head
Head Outer Diameter: 9.5mm (3/8")
Honda

UNIT PACKAGE: 100



23792
Black Phosphate
M4.2-1.41 x 16mm (#8 x 5/8")
Phillips Pan Head with Tek Point
Point Type: #2 Drill

UNIT PACKAGE: 100



12741
(11503395)
Phosphate
M4.2-1.41 x 16mm (#8 x 5/8")
Hex Head Sems®
Washer Outer Diameter: 12mm (15/32")
Hex: 7mm
GM

UNIT PACKAGE: 100



18261
(11503578, 11503785)
Phosphate
M4.2-1.41 x 16mm (#8 x 5/8")
Hex Washer Head Sems® with Teks® Point
Washer Outer Diameter: 12mm (1/2")
Hex: 7mm
GM

UNIT PACKAGE: 50



23795
(471064)
Black
#8 x 5/8"
Hex Washer Head Sems® with Teks® Point
Hex: 9/32"
GM

UNIT PACKAGE: 100



23869
Black Phosphate
M4.2-1.41 x 18mm
Hex Washer Head Sems®
Washer Diameter: 12mm (1/2")
Across Flats: 7mm
Point Type: B

UNIT PACKAGE: 50



23809
(11508827)
Black Finish
M4.2-1.41 x 17mm
Hex Washer Head
Point Type: A/AB
Washer Head Diameter: 9mm

UNIT PACKAGE: 100



24465
Black Finish Steel
M4.2 x 19
Phillips Flat Top Washer Head
Point Type: Self Drilling
Washer Head Diameter: 11mm

UNIT PACKAGE: 100



23837
Black Finish Steel
#8 x 3/4"
Phillips Oval Head Sems®
Head Size: #6
Washer: Flush
Point Type: A/AB

UNIT PACKAGE: 100



13026
(56912-S2)
Phosphate
#8 x 3/4"
Phillips Washer Head
Washer Head Outer Diameter: 31/64"
Ford

UNIT PACKAGE: 100



17460
(382413-S9)
Zinc
#8 x 3/4"
Phillips Round Washer Head
with Teks® Point
Washer Head Outer Diameter: 7/16"
Door Scuff Plate
Ford

UNIT PACKAGE: 50



22537
(Ford: W704874-S439)
Zinc Organic
M4.8-1.59 x 16mm
(Special Hi-Lo Thread)
Hex Washer Head Screw
Washer Diameter: 12.5mm
Hex: 7mm
Ford Escape, Expedition, Explorer,
Fusion, Taurus, Thunderbird, Lincoln
Aviator, Continental, LS, MKC, MKZ,
Navigator, Town Car, Mercury Mariner,
Mountaineer & Sable 2000 - On

UNIT PACKAGE: 25



17650
Phosphate

#8 x 3/4"
Phillips Round Washer Head
with Teks® Point
Washer Head Outer Diameter: 7/16"

UNIT PACKAGE: 50



24589
(11504069)

Chrome Finish Steel

Metric Torx Head
M4.2 x 20
Head Style: Oval

UNIT PACKAGE: 50



24458
(11509707)
Black Steel

M4.2 x 20
Phillips Oval Head
with Loose Flush Washer
Self Drilling

UNIT PACKAGE: 50



22549
(Ford: W704875-S439)
Zinc Organic

M4.2-1.41 x 19mm
Hex Washer Head Tapping Screw
Hex: 7mm
Washer Diameter: 12.5mm
Ford Escape, Explorer, Edge, Expedition,
F-150/250/350/450/550, Flex, Taurus &
Thunderbird and Lincoln LS, Mark LT,
MKX & MKZ 1999 - On

UNIT PACKAGE: 25

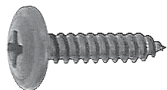

12060
(11501884)
Black Oxide

M4.2-1.41 x 20mm (#8 x 25/32")
Phillips Washer Head
Washer Outer Diameter: 11mm (7/16")
GM

UNIT PACKAGE: 100



24450
Zinc Finish Steel
4.2 x 20mm (#8 x 3/4")
Phillips Flat Washer Head
Washer Diameter: 7/16"

UNIT PACKAGE: 100



22550
(GM: 11609457)
Black Zinc

M4.2-1.41 x 20mm
Round Washer Head Pozi-Drive
Tapping Screw
Head Diameter: 11mm
Tail Lamp Assembly
Buick Cascada, Enclave, Encore, Cadillac
CTS, Chevrolet Avalanche, Camaro,
Caprice, Corvette, Impala, Monte Carlo
& Trax and Pontiac G6 2000 - On

UNIT PACKAGE: 25



12097
(9420052,11502483)
Chrome

M4.2-1.41 x 20mm (#8 x 25/32")
Phillips Pan Head Sems® Pozi-Drive
Washer Outer Diameter: 12mm (1/2")
GM

UNIT PACKAGE: 50

⚠ WARNING: Reproductive Harm & Cancer
www.P65Warnings.ca.gov



12738
(11504056, 11513801)
Phosphate

M4.2-1.41 x 20mm (#8 x 25/32")
Hex Washer Head Sems®
Washer Outer Diameter: 12mm (1/2")
Hex: 7mm
Radiator & Grille
GM

UNIT PACKAGE: 50



12742
(11503396, 11503483)
Phosphate

M4.2-1.41 x 20mm (#8 x 25/32")
Hex Head Sems®
Washer Outer Diameter: 12mm (1/2")
Hex: 7mm
Front End & Air Conditioner
GM

UNIT PACKAGE: 100



24428
Steel

M4.2-1.41 x 20mm (#8 x 25/32")
Hex Head Sems®
Washer Outer Diameter: 12mm (1/2")
Hex: 7mm

UNIT PACKAGE: 50



15373
(11503892, 11500434)
Phosphate

M4.2-1.41 x 20mm (#8 x 25/32")
Hex Head Sems®
Washer Outer Diameter: 16mm (5/8")
Hex: 7mm
GM

UNIT PACKAGE: 50



20271

Phosphate

M4.2-1.41 x 20mm (#8 x 25/32")
Phillips Pan Head Sems®
 Washer Outer Diameter: 16mm (5/8")
 Ford

UNIT PACKAGE: 50



24183

Black Zinc

M4.2-1.41 x 20mm (#8 x 25/32")
Hex Head Sems®
 Washer Diameter: 17mm (11/16")
 Point Type: A/AB

UNIT PACKAGE: 50



20476

Phosphate

M4.2-1.41 x 20mm (#8 x 25/32")
Hex Washer Head Sems® TekS®
 Washer Outer Diameter: 17mm (11/16")
 Hex: 7mm
 General Purpose

UNIT PACKAGE: 50



24475

(11588286)
 Black Steel

Phillips Indented Hex Head
 M4.2-1.41 x 20
 Washer Diameter: 17mm
 Hex: 7mm

UNIT PACKAGE: 50



19278

(GM: 14090382;
 Chry: 6506161-AA)
 Black Phosphate

M4.2-1.41 x 20mm (#8 x 25/32")
Hex Head Sems®
 Washer Outer Diameter: 20mm (25/32")
 Hex: 7mm
 GM

UNIT PACKAGE: 50



15775

Phosphate

M4.2-1.41 x 20mm (#8 x 25/32")
Hex Head Sems® with TekS® point
 Washer Outer Diameter: 12mm (1/2")
 Hex: 7mm

UNIT PACKAGE: 50



22070

(GM: 11570637)
 Black Zinc

M4.2-1.41 x 20mm (#8 x 25/32")
Torx® Pan Head Sems®
Tapping Screw with Dog Point
 T15 Drive

Washer Outer Diameter: 17mm (11/16")
 GM 2007 - On

UNIT PACKAGE: 50



22946

(GM: 11547420)
 Black Zinc

M4.2-1.41 x 20mm
Hex Head Sems® Tapping Screw
 Hex: 7mm

Washer O.D.: 17mm
 Point Type: BR
 Grade: 2

Bumper, Grille & Fog Lamp
 Buick Enclave, Cadillac XT6,
 Chevrolet Blazer, Equinox, Express,
 Silverado, Traverse, GMC Savana,
 Sierra & Terrain 2018 - On
 Malibu 2018 - 2016

UNIT PACKAGE: 25



22104

(Ford: N801169-S900;
 W710763-S901)
 Black Zinc

M4.2-1.41 x 22mm
Hex Head Sems® Tapping Screw

Washer Diameter: 16mm
 Hex Size: 5.5mm

Front Bumper Exterior Trim & Front Fender
 Ford Edge & Expedition and Lincoln MKT &
 MKX 1997 - On

UNIT PACKAGE: 50



24486

(9436165)
 Zinc Steel

Phillips Round Washer Head
 #8 x 7/8"
 Washer Head Diameter: 13/32"
 Chrysler & Universal

UNIT PACKAGE: 100



23867

Chrome

#8 x 1"
Phillips Oval Head Sems®
with Flush Washer
 Head Size: #6
 Point Type: A/AB

UNIT PACKAGE: 50

WARNING: Reproductive Harm & Cancer
www.P65Warnings.ca.gov



18296

Zinc

#8 x 1"

Phillips Round Washer Head with Teks® Point

Washer Head Outer Diameter: 7/16"

General Purpose

UNIT PACKAGE: 50



19006

Phosphate

M4.2-1.41 x 25mm (#8 x 1")

Round Washer Head Pozi-Drive with Teks® Point

Washer Head Outer Diameter: 11mm (7/16")

General Purpose

UNIT PACKAGE: 100



20382

(Not Available from O.E.M.)

Black Zinc

M4.2-1.41 x 25mm (#8 x 1")

Torx® Pan Head Sems®

T-15 Drive

Washer Outer Diameter: 12mm (1/2")

UNIT PACKAGE: 50



22081

(GM: 11609762)

Black Zinc

M4.2-1.41 x 25mm

Pozi-Drive Round Washer Head Sems® Tapping Screw

Washer Diameter: 17mm

Chevrolet Equinox, GMC Acadia & Terrain and Saturn Outlook 2007 - On

UNIT PACKAGE: 50



20376

Black Phosphate

#8 x 1"

Phillips Round Washer Head

Head Diameter: 1/2"

UNIT PACKAGE: 100



18336

Black Phosphate

M4.2-1.41 x 25mm (#8 x 1")

Hex Head Sems®

Washer Outer Diameter: 12mm (1/2")

Hex: 7mm

UNIT PACKAGE: 100



22724

(GM: 11589012)

Black Zinc

M4.2-1.41 x 25mm

Indented Hex Flange

Head Sems® Tapping Screw

Hex: 7mm

Washer Diameter: 12.5mm

Signal Lamp Mounting, Interior Door Trim, Instrument Panel, Radio & Speaker Mounting, Rear Bumper & Liftgate

Buick Allure, Cascada, Enclave, Encore, Envision, LaCrosse, Lesabre, Lucerne, Park Avenue, Rainier, Regal & Verano; Cadillac ATS, CT6, CTS, Deville, DTS, Eldorado, ELR, Escalade, Seville, SRX, STS, XT5 & XTS; Chevrolet Avalanche, Blazer, Bolt EV, Camaro, Captiva Sport, Cobalt, Colorado, Corvette, Cruze, Equinox, Express, HHR, Impala, Lumina, Malibu, Monte Carlo, Orlando, S10, Silverado, Sonic, Spark, SS, SSR, Suburban, Tahoe, Trailblazer, Traverse, Trax & Volt; GMC Acadia, Canyon, Envoy, Savana, Sierra, Sonoma, Terrain & Yukon; Hummer H2 & H3; Pontiac Bonneville, G5, Grand Am, Pursuit, Solstice & Torrent; Saturn Ion, Outlook & Sky 1987-On

UNIT PACKAGE: 50

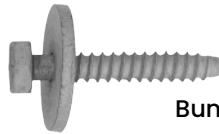

25101

(Ford: W715060-S439)

Zinc Dacromet

Bumper, Fender Apron & Moulding Hex Head Sems® Tapping Screw

M4.2-1.41 x 25mm

Hex: 7mm

Washer Diameter: 17mm

Ford Explorer & Mustang 2010 - On,

Fusion 2013 - On; Lincoln MKZ 2019 - 2013

UNIT PACKAGE: 50



24529

(W710441-S)

Black Steel

M4.2-1.41 x 25

Unslotted Indented Hex Washer Head with Loose Washer

Washer Diameter: 22mm

Hex: 7mm

Ford & Universal

UNIT PACKAGE: 50



24467

(25655545, 11515354)

Black Steel

Hex Head Screw

with Loose Washer

M4.2-1.41 x 25

Washer Diameter: 17mm

Hex: 7mm

UNIT PACKAGE: 50



19653

(N811534-S61)

Black Phosphate

M4.2-1.41 x 30mm (#8 x 1-3/16")

Hex Head Sems®

Washer Outer Diameter: 17mm (11/16")

Hex: 7mm

Ford

UNIT PACKAGE: 15



25150
 (Ford: W711401-S450B)
 Black Zinc & Nickel
 M4.2-1.41 x 34mm
**Hex Head Tapping Screw
 with Sems® Washer & Lock Patch**
 Washer Diameter: 14.5mm
 Hex: 7mm
 Wheel Opening Moulding & Mud Flap
 Ford F250 - F550 SD 2016 - On

UNIT PACKAGE: 25



24517
 (GM: 11514415)
 Black Steel
**Unslotted Indented Hex Head
 With Loose Washer**
 Hex: 7mm
 Washer Diameter: 12mm

UNIT PACKAGE: 50



18460
 Phosphate
 #8 x 1-1/4"
**Phillips Oval Head Sems®
 Flush Washer with #2 Teks® Point**
 Washer Outer Diameter: 3/8"
 Interior Trim

UNIT PACKAGE: 50



19778
 Zinc
 #8 x 1-1/4"
**Phillips Round Washer Head with Teks®
 Point**
 Washer Head Outer Diameter: 7/16"
 General Purpose

UNIT PACKAGE: 50



24538
 (Ford W707484-S900)
 Black Zinc Steel
 M4.2-1.41 x 35
**Phillips Pozidrive
 with Loose Washer**
 Washer Diameter: 16mm

UNIT PACKAGE: 50



24495
 (11518755)
 Black Steel
 M4.2-1.41 x 35
**Indented Hex Head
 with Loose Washer**
 Washer Diameter: 17mm
 Hex: 7mm

UNIT PACKAGE: 50



24132
 Black Phosphate
 #8 x 1-1/2"
Phillips Pan Head with Tek Point
 Point Type: #2 Drill

UNIT PACKAGE: 100



2178
 Zinc
 #10 x 3/8"
Phillips Round Washer Head
 Washer Head Outer Diameter: 31/64"

UNIT PACKAGE: 100



2028
 Zinc
 #10 x 1/2"
Phillips Round Head
 Head Diameter: 11/32"

UNIT PACKAGE: 100



13027
 (9428273)
 Zinc
 #10 x 1/2"
Phillips Flat Washer Head
 Washer Head Outer Diameter: 15/32"
 Chrysler

UNIT PACKAGE: 100



15827
 (9423950)
 Phosphate
 #10 x 1/2"
Phillips Flat Washer Head
 Washer Head Outer Diameter: 15/32"
 Chrysler

UNIT PACKAGE: 100



23581
 #10-16 x 1/2"
Phillips Flat Top
 Head Diameter: 1/2"
 Point Type: A
 For boot well & weatherstrip rails
 GM & Ford
 Convertible & Hardtop

UNIT PACKAGE: 10



18340
 (Nissan: 01451-00841,
 Hyundai & Kia: 12493-05167B)
 Black Phosphate
 M4.8-1.61 x 15mm (#10 x 19/32")
Phillips Truss Head
 Head Outer Diameter: 14mm (9/16")
 Nissan 1998 - On, NV200 2013 - On,
 Bumpers

UNIT PACKAGE: 50



23838

Black Phosphate

M4.8-1.61 x 16mm (#10 x 5/8")

Phillips Oval Head Sems®

Washer: Flush

Point Type: A/AB

UNIT PACKAGE: 100



23835

Chrome

M4.8-1.61 x 16mm (#10 x 5/8")

Phillips Oval Head Sems®

Washer: Flush

Point Type: A/AB

UNIT PACKAGE: 100

⚠ WARNING: Reproductive Harm & Cancer
www.P65Warnings.ca.gov



20364

Zinc

#10 x 5/8"

Phillips Washer Head with Teks® Point and serrations under the Washer Head

Washer Head Outer Diameter: 7/16"

GM

UNIT PACKAGE: 100



17459

Black Oxide

M4.8-1.61 x 16mm (#10 x 5/8")

Phillips Truss Head

Head Outer Diameter: 11mm (7/16")

Imports

UNIT PACKAGE: 100



24176

(07119916946)

Black Zinc

M4.8-1.61 x 16mm (#10 x 5/8")

Hex Head Sems®

Washer Diameter: 15mm

Across Flats: 8mm

Point Type: A/AB

UNIT PACKAGE: 100

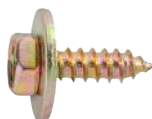

23847

(07119916946)

Zinc

M4.8-1.61 x 16mm (#10 x 5/8")

Hex Head Sems®

Head Diameter: 16mm

Point Type: A/AB

UNIT PACKAGE: 100

⚠ WARNING: Reproductive Harm & Cancer
www.P65Warnings.ca.gov



22030

(BMW: 07-14-7-129-160)

Black Zinc

M4.8-1.61 x 16mm (#10 x 5/8")

Hex Head Sems®

Washer Outer Diameter: 18mm

Hex: 8mm

BMW, 2013 - 1999

UNIT PACKAGE: 50



24427

Steel

M4.8-1.59 x 16mm

Hex Head Sems®

Washer Outer Diameter: 19mm

Hex: 8mm

UNIT PACKAGE: 50



22110

(VW: N90775801, BMW: 07146963883)

Black Zinc

M4.8-1.61 x 18mm

Torx® Truss Head Tapping Screw

T25 Drive

Head Diameter: 15mm

Audi & VW 1998 - On

BMW 5, 6 & 7 Series 2011 - 00

UNIT PACKAGE: 25



20259

(90114-SZ3-000, 90114-SE0-000)

Black E-Coat

M4.8-1.61 x 19mm (#10 x 3/4")

Phillips Truss Head Sems®

Washer Outer Diameter: 16mm (5/8")

Splash Shield & General Purpose

Honda 1986 - On

UNIT PACKAGE: 25



23706

Chrome

#10 x 3/4"

Torx Oval Head

Point Type: A/AB

Head Size: #8

UNIT PACKAGE: 50

⚠ WARNING: Reproductive Harm & Cancer
www.P65Warnings.ca.gov



13709

(9427977)

Zinc

#10 x 3/4"

Phillips Flat Top Washer Head

Washer Head Outer Diameter: 15/32"

Chrysler

UNIT PACKAGE: 50



19240
Black E-Coat
#10 x 3/4"
Phillips Flat Top Round Washer Head
Washer Head Outer Diameter: 1/2"
General Purpose

UNIT PACKAGE: 100



24172
(07119904288)
Black Zinc
M4.8-1.61 x 19mm
Hex Head Sems®
Washer Diameter: 15mm
Across Flats: 8mm
Point Type: A/AB

UNIT PACKAGE: 100



16589
Yellow Zinc Dichromate
#10 x 3/4" (19mm)
Indented Hex Head Sems®
Washer Outer Diameter: 19/32"
Hex: 5/16" (8mm)
Honda, Nissan, Toyota

UNIT PACKAGE: 50

WARNING: Reproductive Harm & Cancer
www.P65Warnings.ca.gov



24473
Black
Hex Head Screw w/Loose Washer
#10 x 1"
Washer Diameter: 5/8"
Hex: 5/16"

UNIT PACKAGE: 50



21774
(Mercedes-Benz: 201-990-05-36)
Black E-Coat
M4.8-1.61 x 20mm (#10 x 25/32")
Hex Head Sems®
Washer Outer Diameter: 26mm
Hex: 8mm
Front Bumper & Moulding Strip
Mercedes-Benz 2014 - 1993

UNIT PACKAGE: 25

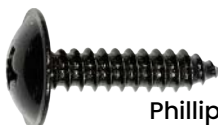

25409
(Hyundai & Kia: 12493-06257-E)
Black Zinc
Phillips Truss Washer Head Tapping Screw
M4.8-1.61 x 25mm
Washer Diameter: 16mm
Drive Type: #3 Phillips
Fender Liner & Mud Guard
Hyundai Elantra 2018 - 2011, Ioniq 2019 - 2017,
Palisade 2021 - 2020, Santa Fe 2019 - 2013,
Tucson 2020 - 2009; Kia Cadenza 2020 - 2017,
Forte 2016 - 2014, Forte5 2018 - 2014,
Rio 2017 - 2012, Sportage 2021 - 2010,
Telluride 2021 - 2020

UNIT PACKAGE: 25



23836
Chrome
#10 x 1"
Phillip Oval Head Sems®
Washer: Flush
Head Size: #8
Point Type: A/AB

UNIT PACKAGE: 100

WARNING: Reproductive Harm & Cancer
www.P65Warnings.ca.gov

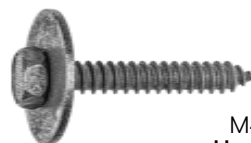

21865
(Chrysler: 6509539-AA)
Phosphate
M4.8-1.61 x 32mm (#10 x 1-1/4")
Hex Head Sems® Tapping Screw
Washer Outer Diameter: 19mm (3/4")
Hex: 8mm
Chrysler Town & Country and
Dodge Ram 2014 - 09

UNIT PACKAGE: 50



19237
(W701649-S,
W704881-S300)
Black Nylon
#10 x 1-1/32"
Cowl Top Vent Grille Nylon Screw
Head Outer Diameter: 9/16"
Use with Auveco 19238
Ford Taurus & Sable 1996 - On

UNIT PACKAGE: 50



21746
(Mitsubishi: MF453091)
Black Oxide
M5-1.59 x 11mm
Phillips Truss Head
Head Outer Diameter: 11mm
Interior Trim
Mitsubishi Galant 2008 - 2004

UNIT PACKAGE: 50



21747
Black Oxide
M5 - 1.59 x 11mm
Phillips Round Washer Head
Washer Head Outer Diameter: 12mm
Chrysler & Imports

UNIT PACKAGE: 50



22294
(Mazda: 9CF600516B)
Black Phosphate
M5-1.81 x 16mm
Phillips Hex Head Sems®
Washer Outer Diameter: 16mm
Hex: 8mm
Mazda 2, 3, 5, 6, 626, 929, CX-5, CX-7, CX-9, Miata,
Millenia, MPV, Mx-3, Protégé, RX-7 & RX-8 2014 - 1992

UNIT PACKAGE: 25



24480

Black Zinc Steel

**Phillips Truss Head
with Loose Washer**

M5 x 20

Washer Diameter: 16mm
Japanese Cars & Universal

UNIT PACKAGE: 25



22203

(Honda: 90103-SDA-A00)

Black Phosphate

M5-1.81 x 20mm

Phillips Flat Head

Head Diameter: 13mm

Front & Rear Bumper

Honda Civic, Pilot & Ridgeline 2006 - On

UNIT PACKAGE: 100



25395

(BMW: 07-14-7-151-963)

Zinc

Hex Head Sems® Tapping Screw

M5-2.12 x 15mm

Hex: 8mm

Washer Diameter: 18mm

Point Type: B

Rocker Moulding

BMW 228i, 428i, 2016 - 2014, 230i 2021 - 2017,
530i, 540i 2017 - On, 740i, M760i, M8 2020 - On,
M550i 2021 - 2018, M850i 2021-2019

UNIT PACKAGE: 25



25397

(BMW: 07-14-9-126-886)

Black Zinc

**Hex Head Sems® Tapping Screw
with Sems® Washer**

M5-2.12 x 18mm

Washer Diameter: 22mm

Hex: 8mm

Fender Apron & Under Cover

BMW 128i, 135i 2013-2012, 135is 2013,
228i, M235i 2021-2020, 2016-2014,
230i, M240i, 2021-2017, 320i 2018-2013,
328d 2018-2014, 328i, 335i, 528i 2016-2012,
330e 2018-2016, 330i 2019-2017, 340i 2019-2016,
428i, 435i, 535d 2016-2014, 430i, 440i, 2020-2017,
535i, 550i 2017-2010, 740i 2015-2011,
750i, 750Li 2015-2009, 760Li 2015-2010,
ActiveHybrid 3, ActiveHybrid 7 2015-2013,
ActiveHybrid 5 2015-2012, M2 2021-2016,
M3, X4 2018-2015, M4 2020-2015, M5 2016-2013,
X1 2021-2013, X2 2018-on, X3, 2021-2011, X6 2014-2008;
Mini Cooper 2020-2014, Clubman 2020-2016,
Countryman 2020-2017, Paceman 2016-2013

UNIT PACKAGE: 25

25394

(BMW: 07-14-7-146-367)

Black Zinc

Phillips Truss Washer Head Tapping Screw

M5-2.12mm X 18mm

Washer Diameter: 16mm

Point Type: AB

Drive Type: #2 Phillips

Bumper & Fender Apron

BMW 528i, 535i, 550i 2016 - 2011, 535d 2016 - 2014,

ActiveHybrid 5 2016 - 2012, M5 2016 - 2013;

Mini Cooper 2015 -2002

UNIT PACKAGE: 25



25203

(BMW: 51-41-7-067-920)

Zinc

**Torx Round Washer Head
Tapping Screw**

M5-2.12 x 16mm

Drive: T20

Washer Diameter: 11mm

Window Reveal Molding

& License Plate Bracket

BMW 228i, 840, M235i, M340i, M8, X6 2020 - On,
330i, M850i 2020 - 2019, 428i, 435i 2016 - 2014, 430i, 440i,

530 2017 - On, 535 2017 - 2011, 540 2020 - 2017,

640 2019 - 2012, 650 2017 - 2012, 740 2019 - 2011,

750 2019 - 2016, Active Hybrid 2016 - 2012,

i8 2020 - 2014, M4 2020 - 2015, M5, M550i 2020 - 2018,

M6 2017 - 2013, 760 2019 - 2017, X3 2020 - 2011,

X4, X5 2018 - 2014; Mini Cooper 2015 - 2012,

Countryman 2016 - 2012, Paceman 2016 - 2013

UNIT PACKAGE: 50



22111

(VW: N90892001, N90775001)

Black Zinc

M5-2.12 x 19mm

Torx® Truss Head Tapping Screw

T25 Drive

Head Diameter: 14mm

Audi, Porsche & VW 2014 - 07

UNIT PACKAGE: 25



20455

Black Phosphate

M5-2.12 x 20mm (#12 x 25/32")

Phillips Truss Head

Head Outer Diameter: 14mm (9/16")

Imports

UNIT PACKAGE: 50



22348

(Ford: W702413-S450B,

W702413-S307)

Black Finish

M5-2.2 x 20mm

Torx® Pan Head Sems® Tapping Screw

T30 Torx® Drive

Washer Diameter: 20mm

Ford C-Max, Escape, Focus & Transit

Connect 2013 - On Ford Edge & F-150

and Lincoln MKC & MKX 2015 - On, Bronco 2021 - On

UNIT PACKAGE: 15





25317
(BMW: 07-14-9-126-885)
Black Finish

Hex Head Sems® Tapping Screw
M5.2-2.12 x 18mm
Hex: 8mm
Washer Diameter: 16mm
Fog Lamp

BMW 228 2021 - 2020, 2016 - 2014, 230, 530, 430, 440,
M240 2020 - 2017, 318 1999 - 1992, 323 2000 - 1998,
325 2006 - 2001, 1995 - 1991, 328 2018 - 1996,
330 2020 - 2017, 2006 - 2001,
540 2020 - 2017, 2003 - 1997, 740 2019 - 2011,
745 2005 - 2002, 750 2019 - 2006, 760 2015 - 2003,
320 2018 - 2013, 2005 - 2001, 1995 - 1993, 335 2016 - 2012,
340 2019 - 2016, 428, 435 2016 - 2014, 525 2003 - 2001,
528 2016 - 2010, 2000 - 1997, 535, 550 2016 - 2010,
640, 650, M6 2019 - 2012, Active Hybrid 3, 5, 7 2016 - 2012,
Alpina 2019 - 2011, 2008 - 2007,
i8, X4, X5, X7 2020 - 2019, M2 2018 - 2016,
M235 2021 - 2014, M3 2018 - 2015, 1999 - 1995,
M340 2020, M4 2017 - 2015, M5 2020 - 2013,
2010 - 2006, M550 2020 - 2018, M760 2019 - 2017,
X1 2021 - 2020, 2015 - 2013, X3 2021 - 2015, Z4 2008 - 2003

UNIT PACKAGE: 25



25202
(BMW: 07-14-9-213-164)
Black Finish

Hex Head Sems Tapping Screw
M5-2.12 x 20mm
Washer Diameter: 22mm
Hex 8mm

Fender Apron & Bumper Cover
BMW 228i, M235i 2020 - On, 330i, M850i30 2019 - On,
528i, 535d, 535i, 550i 2016 - 2011, 530e, 530i, 540d, 540i
2017 - On, 640i, 650i, M6 2019 - 2012, 740,
X3 2011 - On, 750 2009 - On, 760Li 2015 - 2010, 840i,
M340i, M8 2020, Active Hybrid 2016 - 2012, i3, X4,
X6 2015 - On, i8, X5 2014 - On, M5 2013 - On,
M550i 2015 - On, M760i 2017 - On, X1 2016 - On,
X7, Z4 2020 - 2019 Mini Cooper 2014 - On

UNIT PACKAGE: 25



25238
Zinc Dacromet
Phillips Hex Head Sems® Tapping Screw
M5-2.12 x 22mm
Hex: 10mm
Washer Diameter: 18mm
Drive: #3 Phillips
General Purpose

UNIT PACKAGE: 50



21841
(Toyota: 75392-42030)
Black E-Coat
M5.2-2.0 x 20mm (#12 x 25/32")
Phillips Hex Head Sems®
Washer Outer Diameter: 12mm (1/2")
Hex: 8mm
Front Bumper Moulding
Toyota & Lexus 2010 - On
UNIT PACKAGE: 25



21839
(Toyota: 90159-A0001;
90159-50316)
Zinc
M5.2-2.0 x 21mm (#12 x 13/16")
Phillips Hex Head Sems®
Washer Outer Diameter: 14mm (9/16")
Hex: 10mm
Front Bumper, Bumper Stay & Radiator Grille
Toyota & Lexus 2000 - On
UNIT PACKAGE: 25



25225
Black E-Coat
M5.48-1.81 x 18mm
Hex Head Sems® Tapping Screw
Hex: 8mm
Washer Diameter: 15mm
General Purpose
UNIT PACKAGE: 50



21541
(13144822)
Black Zinc
M5.5 x 20mm (12 x 25/32")
Torx® Truss Head
T-20 Drive
Head Outer Diameter: 15mm (19/32")
Use with Auveco 21539 & 21540
GM 2011 - On; Saab 2003 - On
UNIT PACKAGE: 25



22292
(Nissan: 01454-N5061)
Black Phosphate
M5.5-1.81 x 16mm (#12 x 5/8")
Phillips Truss Head
Head Outer Diameter: 13mm
Fender Liner
Nissan Cube, Murano, Pathfinder, Quest,
Rogue, Sentra & Versa 2014 - On, NV200 2013 - On
UNIT PACKAGE: 25



17461
Yellow Zinc Dichromate
M5.5-1.81 x 18mm (#12 x 45/64")
Hex Head Sems®
Washer Outer Diameter: 15mm (19/32")
Hex: 8mm
Imports
UNIT PACKAGE: 50
WARNING: Reproductive Harm & Cancer
www.P65Warnings.ca.gov



21744
(Mitsubishi: MS452348)
Black E-Coat
M6-1.81 x 20mm
Phillips Hex Head Sems®
Washer Outer Diameter: 13mm (1/2")
Hex: 10mm
Bumper, Exterior Trim,
Fender Shield and Quarter Panel
Mitsubishi Diamante, Eclipse, Galant, Lancer,
Mirage, Montero & 3000GT 2012 - 1991
UNIT PACKAGE: 25



25258

(Nissan: 01466-00261)
Zinc

**Bumper Cover Hex Head Tapping
Screw with Sems® Washer**

M6-1.81 x 15mm
Hex: 10mm

Washer Diameter: 18mm
Drive: #3 Phillips

Nissan 350Z 2009 – 2003, 370Z 2009 – On,
Altima, Versa 2007 – On, Armada 2017 – On,
Frontier 2000, GT-R 2015 – 2009, Juke 2017 – 2011,
Kicks 2008 – On, Leaf 2011 – On, Maxima 2000 – On,
Murano 2014 – On, NV1500, NV2500 2013 – 2012,
NV3500 2015 – 2012, Pathfinder, Sentra 2013 – On,
Quest 2017 – 2005, Rouge 2020 – 2008, Titan 2004 – On,
XTrail 2021 – On

UNIT PACKAGE: 25



19170

Black Phosphate

M6.3-1.81 x 16mm (#14 x 5/8")

Phillips Truss Head

Head Outer Diameter: 15mm (19/32")

Japanese Imports

UNIT PACKAGE: 50



15776

(N800312-S2)
Phosphate

M6.3-1.81 x 16mm (#14 x 41/64")

Hex Head Sems®

Washer Outer Diameter: 16mm (5/8")

Hex: 8mm
Ford

UNIT PACKAGE: 50



12057

(11500994, 11509371)
Phosphate

M6.3-1.81 x 16mm (#14 x 41/64")

Hex Head Sems®

Washer Outer Diameter: 17mm (11/16")

Hex: 10mm
GM

UNIT PACKAGE: 50



22106

(Toyota: 90159-60303)
Zinc

M6.3-2.5 x 18mm

Phillips Hex Head Sems® Tapping Screw

Washer Outer Diameter: 14mm

Hex: 10mm

Toyota & Scion 1993 – On

UNIT PACKAGE: 25



13021

(55914-S2)
Phosphate

#14 x 3/4"

Hex Washer Head

Washer Head Outer Diameter: 1/2"

Hex: 3/8"
Ford

UNIT PACKAGE: 50



23864

(55914-S2)

Black Phosphate

#14 x 3/4"

Phillips Hex Washer Head

Washer Head Outer Diameter: 1/2"

Across Flats: 3/8"
Point Type: A/AB

UNIT PACKAGE: 50



23850

(6033854)

Black Zinc

#14 x 3/4"

**Hex Serrated Washer Head
with Pierce Point**

Washer Head Diameter: 5/8"

Across Flats: 3/8"

UNIT PACKAGE: 50



23758

Black Phosphate

#14 x 3/4"

Hex Washer Head

Screw Size: 1/4"

Across Flats: 3/8"

Point Type: A/AB

UNIT PACKAGE: 100



13019

(N610959-S2)
Phosphate

M6.3-1.81 x 19mm (#14 x 3/4")

Hex Washer Head

Washer Head Outer Diameter: 11.5mm (29/64")

Hex: 8mm
Ford

UNIT PACKAGE: 50



24441

Black Zinc

Phillips Hex with Loose Washer

M6.3-1.81 x 20

Washer Diameter: 13mm

Hex: 10mm

UNIT PACKAGE: 50



20556
Black Zinc

M6.3-1.81 x 20mm (#14 x 25/32")
Phillips Hex Head Sems®
Washer Outer Diameter: 16mm (5/8")
Hex: 10mm
Imports

UNIT PACKAGE: 50



12351
(11505022)

Black Phosphate

M6.3-1.81 x 20mm (#14 x 25/32")
Hex Washer Head Sems®
Washer Outer Diameter: 17mm (11/16")
Hex: 10mm
GM

UNIT PACKAGE: 50

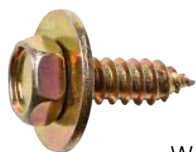

16828

Yellow Zinc Dichromate

M6.3-1.81 x 20mm (#14 x 25/32")
Hex Head Sems®
Washer Outer Diameter: 18mm (45/64")
Hex: 10mm

Honda, Nissan & Toyota

UNIT PACKAGE: 25

WARNING: Reproductive Harm & Cancer
www.P65Warnings.ca.gov



25226

Black E-Coat

M6.3-1.81 x 20mm
Hex Head Sems® Tapping Screw
Hex: 10mm
Washer Diameter: 18mm
General Purpose

UNIT PACKAGE: 25



20557
Black Zinc

M6.3-1.81 x 20mm (#14 x 25/32")
Phillips Hex Head Sems®
Washer Outer Diameter: 20mm (25/32")
Hex: 10mm
Imports

UNIT PACKAGE: 50



24173
(11503412)
Black Zinc

M6.3-1.81 x 20mm (#14 x 25/32")
Hex Head Sems®
Washer Diameter: 23.5mm
Across Flats: 10mm
Point Type: A/AB
UNIT PACKAGE: 50



18934
(6034703, 6035188)
Zinc Organic

#14 x 7/8"
Hex Washer Head
Serrations under the Washer Head
Washer Head Outer Diameter: 13/16"
Hex: 3/8"
Front Fender & Fascia Attachment
Chrysler 1993-On

UNIT PACKAGE: 25



23695

Black Zinc

M6.3-1.81 x 22mm
Hex Head Sems®
Washer Diameter: 24mm
Across Flats: 10mm
Point Type: A/AB

UNIT PACKAGE: 50



21838

(Toyota: 90159-60488)
Zinc

M6.3-2.5 x 24mm (#14 x 15/16")
Phillips Hex Head Sems®
Washer Outer Diameter: 16mm (5/8")
Hex: 10mm
Front Bumper, Bumper Stay, Hood and Front Fender
Lexus CT200, ES350, HS250, IS & SC430,
Scion and Toyota 1995 - On

UNIT PACKAGE: 25



12339

(11500996, 11505023)
Phosphate

M6.3-1.81 x 25mm (#14 x 1")
Hex Head Sems®
Washer Outer Diameter: 17mm (21/32")
Hex: 10mm
GM

UNIT PACKAGE: 50



23803

Zinc

M6.3-1.81 x 25mm (#14 x 1")
Hex Head Sems®
Washer Diameter: 3/4"
Across Flats: 7/16"
Point Type: A/AB

UNIT PACKAGE: 100



24466
(11507083)
Black Steel

M6.3 x 25
Hex Head Screw with Loose Washer
Washer Diameter: 24mm
Hex: 10mm
GM & Universal

UNIT PACKAGE: 25



12354
(11500997)
Phosphate

M6.3-1.81 x 30mm
(#14 x 1-3/16")
Hex Head Sems®
Washer Outer Diameter: 17mm (21/32")
Hex: 10mm
GM

UNIT PACKAGE: 5



12068
(11504981)
Phosphate

M6.3-1.81 x 30mm
(#14 x 1-3/16")
Hex Head Sems®
Washer Outer Diameter: 24mm(15/16")
Hex: 10mm
GM

UNIT PACKAGE: 50



25237
Black E-Coat

Phillips Hex Head Sems®
Tapping Screw
M6.3-2.5 x 16mm
Hex: 10mm
Washer Diameter: 18mm
Drive: #3 Phillips
General Purpose

UNIT PACKAGE: 50



25078

(Lexus & Toyota: 90159-60498, 90159-60603)
Black Dacromet

Phillips Indented Hex Head Sems®
Tapping Screw

M6.3-2.5 x 18mm
Hex: 10mm
Washer Diameter: 16mm
Drive: #3 Phillips
Bumper & Wheel Apron
Lexus ES300h 2018 - 2013, ES350, GS450h 2018-2007,
GS F, RC300 2020 - 2016, GS Turbo 2017,
GS200t, IS200t, RC200t 2017 - 2016, GS300 2019 - 2018 &
2006, GS350 2020 - 2007, GS430 2007 - 2006,
GS460 2011 - 2008, GX460 2021 - 2010,
GX470 2009 - 2003, IS F 2014 - 2008,
IS250, IS350 2015 - 2006, IS300, LX570 2021 - 2016,
LS430 2006 - 2004, LS460 2017 - 2007,
LS600h 2012 - 2008, NX200t 2017 - 2015, NX300, RX350L,
RX450hL 2021 - 2018, RC F, RC350 2021 - 2015,
RX350, RX450h 2022 - 2016
Scion iM 2016, iQ 2015 - 2012, tC 2016 - 2011,
xA 2006 - 2004, Toyota 4Runner 2022 - 2003,
Avalon 2021 - 2019, Corolla 2008 - 2006,
Corolla iM 2018 - 2017, Echo, MR2 Spyder 2005 - 2000,
FJ Cruiser 2014 - 2007, Highlander 2019 - 2014,
Prius 2015 - 2001, Prius Prime 2022 - 2020,
RAV4 2012 - 2006, Sequoia 2021 - 2002,
Tacoma 2021 - 2005, Tundra 2021 - 2004,
Yaris 2018 - 2007

UNIT PACKAGE: 50



24442
(11503436)
Black Steel

Hex Head Screw
with Loose Washer
M6.3 x 35
Washer Diameter: 24mm
Hex: 10mm
GM & Universal

UNIT PACKAGE: 25



22295

(Hyundai: 12493-06207B)
Black Phosphate

M6.5-1.81 x 18mm
Phillips Truss Head
Head Outer Diameter: 16mm
Fender Liner
Hyundai Accent, Azera, Elantra, Entourage,
Genesis, I30, Santa Fe, Sonata, Tiburon,
Tucson, Veloster & Veracruz 2013 - 2005

UNIT PACKAGE: 25



22296

(Hyundai: 92155-22000;
11254-06206)
Black Phosphate

M6.5-1.81 x 25mm

Phillips Truss Head

Head Outer Diameter: 16mm
Headlamp Assembly Mounting Screw
Hyundai 2000 - On

UNIT PACKAGE: 25



21837

(Toyota: 90159-60525)
Black E-Coat

M6.5-2.5 x 19mm (#14 x 3/4")

Phillips Hex Head Sems®

Washer Outer Diameter: 20mm (25/32")
Hex: 10mm

Floor Pan & Lower Back Panel Moulding,
Rear Bumper Stay, Suspension Cross
Member and Under Cover
Toyota 1998 - On

UNIT PACKAGE: 25

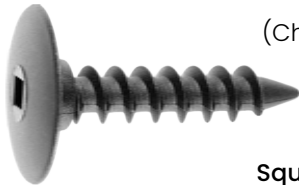

19417

(Chry: 6503819, 6503401;
GM: 25631448)
Black Nylon

M7.5 x 35mm

Square Drive Truss Head

Head Diameter: 22mm
Shoulder Diameter: 9mm
Foam to Bumper Fascia
Chrysler 1993-On
GM 1997-On

UNIT PACKAGE: 15



12350

(11500086)
Phosphate

M8-2.12 x 20mm (5/16"-12 x 25/32")

Hex Washer Head

Washer Head Outer Diameter: 16mm (5/8")
Hex: 13mm
GM

UNIT PACKAGE: 25



10364

Black Oxide

5/16"-12 x 7/8"

Hex Washer Head

Washer Head Outer Diameter: 21/32"
Hex: 1/2"

UNIT PACKAGE: 100



10714

(9796223)
Phosphate

5/16"-12 x 1"

Hex Washer Head

Washer Head Outer Diameter: 21/32"
Hex: 1/2"
GM

UNIT PACKAGE: 50



21517

(GM: 25705182)
Black Nylon

M9.5 x 46mm

Bumper Fascia Nylon Screw

Square Drive
Head Diameter: 22mm
GM 2004 - On

UNIT PACKAGE: 25



20970

(Not Available from O.E.M.)
Black Nylon

M14 x 34mm

**Bumper and Door Insulator
Nylon Screw**

No. 3 Square Drive
Head Outer Diameter: 22mm
Fits into 12mm Hole
GM, Ford & Chrysler 2005 - On

UNIT PACKAGE: 25

Sec. 05

License Plate Screw Specification Chart



Auveco Part No.	Size	Length	Hex Size	Washer/ Head O.D.	Type	Point Type	Finish	Unit Pkg.	Page No.
Machine Screw Thread									
23868	M5-0.8	8mm		12mm	Phillips Pan Washer Head		Zinc	100	65
18779	M5-0.8 (15/32")	12mm	(1/2")	12.7mm	Phillips Pan Washer Head	B	Yellow Zinc Dichromate	100	65
25239	M6-1.0	8mm		11.8mm	Phillips Pan Head			25	65
17315	M6-1.0	12mm (15/32")	10mm	14mm (9/16")	Hex Flange Head	B	Zinc & Clear	50	65
23985	M6-1.0	12mm			Slotted Phillips Truss Head		Silver Dacromet	50	65
22888	M6-1.0			12mm	Phillips Pan Head			25	65
24471	M6-1.0			16mm	Phillips Pan Head			25	65
17316	M6-1.0	16mm (5/8")	10mm	14mm (9/16")	Hex Flange Head	B	Zinc & Clear	50	66
24163	M6-1.0	16mm			Phillips Pan Head	B	Black Zinc	100	66
14473	M6-1.0	16mm (5/8")		14mm (9/16")	Slotted Round Washer Head	B	Zinc	50	66
17152	M6-1.0	16mm (5/8")		14mm (9/16")	Slotted Round Washer Head	B	Black E-Coat	50	66
20680	M6-1.0	16mm (5/8")		14mm (9/16")	Phillips Round Washer Head	BT	Black Zinc	50	66
21181	M6-1.0	16mm (5/8")		12mm (15/32")	Slotted Pan Head with Hex Nut	B	Black Nylon	50 Sets	70
15413	M6-1.0	20mm (25/32")		12mm (15/32")	Slotted Pan Head with Hex Nut	B	Black Nylon	50 Sets	70
21606	M6-1.0	20mm (25/32")		12mm (15/32")	Phillips Pan Head with Hex Nut	B	Black Nylon	50 Sets	70
13934	M6-1.0	20mm (25/32")		12mm (15/32")	Slotted Pan Head with Hex Nut	B	Natural Nylon	25 Sets	70
18769	M6-1.0	20mm (25/32")		12mm (15/32")	Phillips Pan Head	B	Black E-Coat	50	67
23677	M6-1.0	20mm			Phillips Pan Head		Trivalent Yellow Zinc	50	67
16826	M6-1.0	20mm (25/32")	10mm	13mm (1/2")	Slotted Hex Washer Head	CA	Zinc	50	67
18239	M6-1.0	25mm (1")		12mm (15/32")	Slotted Pan Head with Hex Nut	B	Natural Nylon	25 Sets	70
18241	M6-1.0	25mm (1")		12mm (15/32")	Slotted Pan Head with Hex Nut	B	Black Nylon	25 Sets	70
1313	1/4"-20	1/2"		9/16"	Slotted Truss Head with Hex Nut	B	Zinc	100 Sets	68
3184	1/4"-20	1/2"		9/16"	Slotted Truss Head with Square Nut	B	Zinc	100 Sets	68
23502	1/4"-20	9/16"		1/2"	Slotted Round Washer Head		Zinc	100	68
3182	1/4"-20	1/2"		1/2"	Slotted Round Washer Head with Hex Nut	B	Zinc	100 Sets	68
3183	1/4"-20	1/2"		1/2"	Slotted Round Washer Head with Square Nut	B	Zinc	100 Sets	68
23503	1/4"-20	9/16"		1/2"	Slotted Round Washer Head		Zinc	100	69
5885	1/4"-20	1/2"		1/2"	Slotted Round Washer Head with Wing Nut	B	Zinc	50 Sets	69
8427	1/4"-20	5/8"		1/2"	Slotted Pan Head with Nylon Nut	F	Zinc	50 Sets	69

(Continued on next page)

License Plate Screw Specification Chart



Auveco Part No.	Size	Length	Hex Size	Washer/ Head O.D.	Type	Point Type	Finish	Unit Pkg.	Page No.
Machine Screw Thread (continued)									
13922	1/4"-20	5/8"		19/32"	Slotted Truss Washer Head with Washer Nut	B Nylon	Natural Sets	25	69
18484	1/4"-20	5/8"		19/32"	Slotted Truss Washer Head with Washer Nut	B	Black Nylon Sets	25	69
23504	1/4"-20	5/8"			Slotted Truss Head		Zinc	100	67
23505	1/4"-20	9/16"			Slotted Truss Washer Head With Square Washer		Zinc	100	67
5910	1/4"-20	3/4"		9/16"	Slotted Truss Head	B	Zinc	100	67
2472	1/4"-20	3/4"		9/16"	Slotted Round Washer Head with Square Nut	B	Zinc	100	69
Tapping Screw Thread									
18156	M4.8-1.59 (#10)	16mm (5/8")		10mm (3/8")	Phillips Wafer Head	AB	Yellow Zinc	50	65
5278	#10	5/8"		1/2"	Slotted Truss Washer Head	AB	Zinc	100	65
17980	M6-1.81 (1/4"-14)	16mm (5/8")	10mm	13mm (1/2")	Phillips Hex Washer Head	AB	Yellow Zinc Dichromate	50	66
16960	M6-1.81 (1/4"-14)	20mm (25/32")	10mm	12mm (15/32")	Phillips Hex Washer Head	AB	Yellow Zinc Dichromate	50	67
25295	M6-1.81 (1/4"-14)	20mm (3/4")	10mm	12.7mm (1/2")	Phillips Hex Washer Head		Zinc	50	67
22757	M6-1.0	29mm		13mm	Phillips Round Head		Black Zinc	25	67
17098	M6.3-1.81 (1/4"-14)	15mm (19/32")		13mm (1/2")	Phillips Truss Head	AB	Yellow Zinc Dichromate	50	65
19777	M6.3-1.81 (#14)	16mm (5/8")		14mm (9/16")	Duo-Drive Truss Head	B	Dacromet 320	50	66
21081	M6.3-1.81 (#14)	20mm (25/32")		14mm (9/16")	Duo-Drive Truss Head	AB	Dacromet 320	50	67
15170	#14	1/2"			Thumb Screw	AB	Zinc Die Cast	25	68
15758	#14	5/8"		9/16"	Slotted Truss Head	Dog Pt	Zinc	50	65
8249	1/4"	5/8"		9/16"	Slotted Round Washer Head	B	Zinc	100	66
8250	1/4"	5/8"		9/16"	Slotted Round Washer Head with Nylon Nut	B	Zinc	25	69
16421	#14 (1/4")	5/8"	5/16"	5/8"	Slotted Hex Washer Head	B	Black E-Coat	50	66
16422	#14 (1/4")	5/8"	5/16"	5/8"	Slotted Hex Washer Head	B	Zinc	50	66
20446	#14 (1/4")	5/8"	5/16"	5/8"	Slotted Hex Washer Head	AB	Black E-Coat	50	66
21609	#14	3/4"		15/32"	Phillips Pan Head	A	Stainless Steel	100	66
9603	#14	3/4"		9/16"	Slotted Truss Head	AB	Zinc	100	67
16323	#14	3/4"		9/16"	Slotted Truss Head	AB	Black E-Coat	100	67
11369	#14	3/4"	3/8"	1/2"	Slotted Hex Washer Head	AB	Zinc	50	67
11370	#14	3/4"	3/8"	1/2"	Slotted Hex Washer Head with Nylon Nut	AB	Zinc	25	69
18354	#14	3/4"	3/8"	1/2"	Slotted Hex Washer Head	AB	Black E-Coat	50	68
20301	#14	1-3/16"		9/16"	Slotted Truss Head	B	Black E-Coat	50	68



18156
 (51-81-1-821-830)
 Yellow Zinc
 M4.8-1.59 x 16mm (#10 x 5/8")
Phillips Wafer Head License Plate Screw
 Head O.D.: 10mm (3/8")
 BMW

UNIT PACKAGE: 50
 ⚠️ **WARNING:** Reproductive Harm & Cancer
www.P65Warnings.ca.gov



5278
 (3783002)
 Zinc
 #10 x 5/8"
Slotted Truss Washer Head License Plate Screw
 Washer Head O.D.: 1/2"
Use with Auveco Nut 5228
 GM

UNIT PACKAGE: 100



23868
 (Not Available from OEM)
 Zinc Finish
 M5-0.8 x 8MM
Phillips Pan Washer Head License Plate Screw
 Washer Head Diameter: 12mm
 Ford Contour &
 Mercury Mystique 1995 - On

UNIT PACKAGE: 100



18779
 Yellow Zinc Dichromate
 M5-0.8 x 12mm
Phillips Pan Washer Head License Plate Screw
 Washer Head O.D.: 12.7mm (1/2")
 Ford Contour & Mercury Mystique 1995-On

UNIT PACKAGE: 100
 ⚠️ **WARNING:** Reproductive Harm & Cancer
www.P65Warnings.ca.gov



25239
 Stainless Steel
 M6-1.0- x 8mm
Metric Phillips Pan Head 18-8 License Plate Screw
 Head Diameter: 11.8mm

UNIT PACKAGE: 25



17315
 Zinc & Clear
 M6-1.0 x 12mm
Hex Flange License Plate Screw
 Flange O.D.: 14mm (9/16")
 Hex: 10mm
 Class 10.9
 Acura
UNIT PACKAGE: 50



23985
 25910528
 Silver Dacromet
 M6-1.0 x 12mm
Duo-Drive Truss Head License Plate Screw
 Cadillac SRX & General Purpose

UNIT PACKAGE: 50



22888
 Stainless Steel
 M6-1.0- x 12mm
Metric Phillips Pan Head 18-8 License Plate Screw
 Head Diameter: 11.8mm

UNIT PACKAGE: 25



24471
 Stainless Steel
 M6-1.0- x 16mm
Metric Phillips Pan Head 18-8 License Plate Screw
 Head Diameter: 11.8mm

UNIT PACKAGE: 25



17098
 Yellow Zinc Dichromate
 M6.3-1.81 x 15mm (1/4"-14 x 19/32")
Phillips Truss Head License Plate Screw
 Head Diameter: 13mm (1/2")

UNIT PACKAGE: 50
 ⚠️ **WARNING:** Reproductive Harm & Cancer
www.P65Warnings.ca.gov



15758
 Zinc
 #14 x 5/8"
Slotted Truss Head with Dog Point License Plate Screw
 Head O.D.: 9/16"

UNIT PACKAGE: 50



8249
 Zinc
 1/4" x 5/8"
Slotted Round Washer Head License Plate Screw
 Washer Head O.D.: 9/16"

UNIT PACKAGE: 100



16421
 (N800369-S2)
 Black E-Coat
 #14 (1/4") x 5/8"
Slotted Hex Washer Head License Plate Screw
 Washer Head O.D.: 5/8"
 Hex: 5/16"
 Ford

UNIT PACKAGE: 50



16422
(N800369)
Zinc

#14 (1/4") x 5/8"
Slotted Hex Washer Head License Plate Screw
Washer Head O.D.: 5/8"
Hex: 5/16"
Ford

UNIT PACKAGE: 50



20446
Black E-Coat

#14 (1/4") x 5/8"
Slotted Hex Washer Head License Plate Screw
Washer Head O.D.: 5/8"
Hex: 5/16"
Ford

UNIT PACKAGE: 50



17980

Yellow Zinc Dichromate
M6-1.81 x 16mm (1/4"-14 x 5/8")
Phillips Hex Washer Head License Plate Screw
Washer Head O.D.: 13mm (1/2")
Hex: 10mm

UNIT PACKAGE: 50

WARNING: Reproductive Harm & Cancer
www.P65Warnings.ca.gov



24163
Black Zinc

M6-1.0 x 16mm
Phillips Pan Head License Plate Screw
General Usage & Imports
UNIT PACKAGE: 100



17316
Zinc & Clear

M6-1.0 x 16mm
Hex Flange License Plate Screw
Flange O.D.: 14mm (9/16")
Hex: 10mm
Class 10.9
Acura

UNIT PACKAGE: 50



14473
Zinc

M6-1.0 x 16mm
Slotted Round Washer Head License Plate Screw
Washer Head O.D.: 14mm (9/16")
UNIT PACKAGE: 50



17152

Black E-Coat (168 Hours Salt Spray)
M6-1.0 x 16mm
Slotted Round Washer Head License Plate Screw
Washer Head O.D.: 14mm (9/16")

UNIT PACKAGE: 50



20680
Black Zinc

M6-1.0 x 16mm
Phillips Round Washer Head Thread Cutting License Plate Screw
Washer Head O.D.: 14mm (9/16")
Hyundai

UNIT PACKAGE: 50



19777

Dacromet 320
M6.3-1.81 x 16mm (#14 x 5/8")
Duo-Drive Truss Head License Plate Screw
Head Diameter: 14mm
GM

UNIT PACKAGE: 50



21609

Stainless Steel
#14 x 3/4"
Phillips Pan Head License Plate Screw
Head O.D.: 15/32"

UNIT PACKAGE: 100



23504
Zinc

1/4"-20 x 5/8"
Slotted Truss Head License Plate Screw

UNIT PACKAGE: 100



23505
Zinc Plated

1/4"-20 x 5/8"
Truss Head License Plate Bolt with Sq. Nut

UNIT PACKAGE: 100



5910
Zinc

1/4"-20 x 3/4"
Slotted Truss Head License Plate Screw
Head Diameter: 9/16"

UNIT PACKAGE: 100



9603
Zinc

#14 x 3/4"
Slotted Truss Head License Plate Screw
Head Diameter: 9/16"

UNIT PACKAGE: 100



16323

Black E-Coat (168 Hours Salt Spray)
#14 x 3/4"
Slotted Truss Head License Plate Screw
Head Diameter: 9/16"

UNIT PACKAGE: 100



18769
 Black E-Coat
 (168 Hours Salt Spray)
 M6-1.0 x 20mm
Phillips Pan Head License Plate Screw
 Head Diameter: 12mm (15/32")

UNIT PACKAGE: 50



23677
 Trivalent Yellow Zinc
 M6-1.0 x 20mm
Phillips Pan Head License Plate Screw
 Ford Fiesta 1978 - On

UNIT PACKAGE: 50
 ⚠️ **WARNING:** Reproductive Harm & Cancer
www.P65Warnings.ca.gov



16826
 (Chry: 34201287;
 AMC: 8934201287)
 Zinc
 M6-1.0 x 20mm
Slotted Hex Washer Head License Plate Screw
 Washer Head O.D.: 13mm (1/2")
 Hex: 10mm
 Chrysler, Honda & AMC
 UNIT PACKAGE: 50



16960
 (Toyota: 93904-46320;
 Honda: 91500-SM4-999AH)
 Yellow Zinc Dichromate
 M6-1.81 x 20mm (1/4"-14 x 3/4")
Phillips Hex Washer Head License Plate Screw
 Washer Head O.D.: 12mm (1/2")
 Hex: 10mm
 Honda, GEO Prizm & Toyota 1990-On

UNIT PACKAGE: 50
 ⚠️ **WARNING:** Reproductive Harm & Cancer
www.P65Warnings.ca.gov



25295
 Zinc Finish
Phillips Hex Washer Head License Plate Screw
 M6-1.81 x 20mm (1/4"-14 x 3/4")
 Washer Head O.D.: 12.7mm (1/2")
 Hex: 10mm
 General Purpose

UNIT PACKAGE: 50



22757
 (Hyundai: 12291-06303)
 Black Zinc
 M6-1.0 x 29mm
Phillips Round Head License Plate Screw with Sems® Flat & Lock Washer
 Sems® Flat Washer Diameter: 13mm
 Sems® Lock Washer Diameter: 11mm
 Hyundai Equus 2015 - 2010
 Genesis 2014 - 2008
 UNIT PACKAGE: 25



11369
 Zinc
 #14 x 3/4"
Slotted Hex Washer Head License Plate Screw
 Washer Head O.D.: 1/2"
 Hex: 3/8"
 Ford

UNIT PACKAGE: 50



23280
 #14 x 3/4"
Slotted Hex Washer Head License Plate Nut & Screw
 Ford & Universal

UNIT PACKAGE: 50



23283
 #14 x 3/4"
Slotted Hex Washer Head License Plate Nut & Screw
 GM & Universal

UNIT PACKAGE: 50



18354
 Black E-Coat
 (168 Hours Salt Spray)
 #14 x 3/4"
Slotted Hex Washer Head License Plate Screw
 Washer Head O.D.: 1/2"
 Hex: 3/8"
 Ford

UNIT PACKAGE: 50

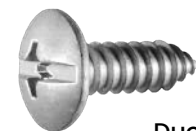

21081
 (25732397)
 Dacromet 320
 M6.3-1.81 x 20mm
 (#14 x 3/4")
Duo-Drive Truss Head License Plate Screw
 Head Diameter: 14mm
 GM 2002 - On

UNIT PACKAGE: 50



20301
 (16502342)
 Black E-Coat
 (168 Hours Salt Spray)
 #14 x 1-3/16"
Slotted Truss Head License Plate Screw
 Head Diameter: 9/16"
 GM S & T Trucks 1998 - On

UNIT PACKAGE: 50



15170
#14 x 1/2"
Dealer License
Plate Thumb Screw
Overall Length: 1-1/8"
UNIT PACKAGE: 25



25207
M6-1.0 x 12mm"
Phillips Hex Head Sems®
License Plate Bolt
With Dog Point
Washer Diameter: 14mm
Hex: 10mm
UNIT PACKAGE: 50



25208
M6-1.0 x 16mm"
Phillips Hex Head Sems®
License Plate Bolt
With Dog Point
Washer Diameter: 14mm
Hex: 10mm
UNIT PACKAGE: 50



25209
M6-1.0 x 20mm"
Phillips Hex Head Sems®
License Plate Bolt
With Dog Point
Washer Diameter: 14mm
Hex: 10mm
UNIT PACKAGE: 50



1313
Zinc
1/4"-20 x 1/2"
Slotted Truss Head
License Plate Screw with Hex Nut
Head Diameter: 9/16"
Hex Width (ATF): 7/16"
UNIT PACKAGE: 100 Sets



3184
Zinc
1/4"-20 x 1/2"
Slotted Truss Head
License Plate Screw with Square Nut
Head Diameter: 9/16"
ATF: 7/16"
UNIT PACKAGE: 100 Sets



23502
Zinc Plated
1/4"-20 x 1/2"
Slotted Washer Head
License Plate Bolt with Hex Nut
UNIT PACKAGE: 100



3182
Zinc
1/4"-20 x 1/2"
Slotted Round Washer Head
License Plate Screw with Hex Nut
Washer Head O.D.: 1/2"
Hex Width (ATF): 7/16"
UNIT PACKAGE: 100 Sets



3183
Zinc
1/4"-20 x 1/2"
Slotted Round Washer Head
License Plate Screw
with Square Nut
Washer Head O.D.: 1/2"
ATF: 7/16"
UNIT PACKAGE: 100 Sets

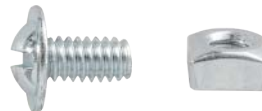

23503
Zinc Plated
1/4"-20 x 1/2"
Slotted Washer Head
License Plate Bolt with Sq. Nut
UNIT PACKAGE: 100



5885
Zinc
1/4"-20 x 1/2"
Slotted Round Washer Head
License Plate Screw with Flat Washer
and Wing Nut
Washer Head O.D.: 1/2"
Washer O.D.: 5/8"
UNIT PACKAGE: 50 Sets



8250
Zinc
1/4" x 5/8"
Slotted Round Washer Head
License Plate Screw and Nylon
Nut (Auveco No. 8249)
Washer Head O.D.: 9/16"
Chrysler
UNIT PACKAGE: 25 Sets



8427
(379046-S)
Zinc

1/4"-20 x 5/8"
Slotted Pan Head Type F Thread Cutting License Plate Screw and Nylon Nut (Auveco 5307 & 3682)
Head Diameter: 1/2"

UNIT PACKAGE: 50 Sets



2472
Zinc

1/4"-20 x 3/4"
Slotted Truss Head License Plate Screw with Square Nut
Head Diameter: 9/16"
Hex Width (ATF): 7/16"

UNIT PACKAGE: 100 Sets



11370
Zinc

#14 x 3/4"
Slotted Hex Washer Head License Plate Screw and Nylon Nut (Auveco 11368 & 11369)
Washer Head O.D.: 1/2"
Hex: 3/8"
Ford

UNIT PACKAGE: 25 Sets



13922
Natural Nylon
1/4"-20 x 5/8"
Slotted Truss Washer Head
Washer Head O.D.: 19/32"
Washer Nut O.D.: 9/16"
Hex Width (ATF): 7/16"

UNIT PACKAGE: 25 Sets

17171
Screw only from 13922

UNIT PACKAGE: 50

17228
Nut only from 13922

UNIT PACKAGE: 50

18342
Screw only from 13922

UNIT PACKAGE: 1000

18346
Nut only from 13922

UNIT PACKAGE: 1000



18484
Black Nylon
1/4"-20 x 5/8"
Slotted Truss Washer Head
Washer Head O.D.: 19/32"
Washer Nut O.D.: 9/16"
Hex Width (ATF): 7/16"

UNIT PACKAGE: 25 Sets

18485
Screw only from 18484

UNIT PACKAGE: 50

18486
Screw only from 18484

UNIT PACKAGE: 1000

18487
Nut only from 18484

UNIT PACKAGE: 50

18488
Nut only from 18484

UNIT PACKAGE: 1000



21181
Black Nylon
M6-1.0 x 16mm
Slotted Pan Head
Head Diameter: 12mm (15/32")
Hex Width (ATF): 10mm (25/64")

UNIT PACKAGE: 50 Sets

21182
Screw only from 21181

UNIT PACKAGE: 100

21183
Screw only from 21181

UNIT PACKAGE: 1000

18348
Nut only from 21181

UNIT PACKAGE: 1000



15413

Black Nylon

M6-1.0 x 20mm
Slotted Pan Head

Head Diameter: 12mm (15/32")
Hex Width (ATF): 10mm (25/64")

UNIT PACKAGE: 50 Sets

17091

Screw only from 15413

UNIT PACKAGE: 100

18348

Nut only from 15413

UNIT PACKAGE: 1000



13934

Natural Nylon

M6-1.0 x 20mm
Slotted Pan Head

Head Diameter: 12mm (15/32")
Hex Width (ATF): 10mm (25/64")

UNIT PACKAGE: 25 Sets

17169

Screw only from 13934

UNIT PACKAGE: 100

18343

Screw only from 13934

UNIT PACKAGE: 1000

18347

Nut only from 13934

UNIT PACKAGE: 1000



21606

Black Nylon

M6-1.0 x 20mm

Phillips Pan Head

Head Diameter: 12mm (15/32")
Hex Width (ATF): 10mm (25/64")

UNIT PACKAGE: 50 Sets

21607

Screw only from 21606

UNIT PACKAGE: 100

21608

Screw only from 21606

UNIT PACKAGE: 1000

18348

Nut only from 21606

UNIT PACKAGE: 1000



18239

Natural Nylon

M6-1.0 x 25mm
Slotted Pan Head

Head Diameter: 12mm (15/32")
Hex Width (ATF): 10mm (25/64")

UNIT PACKAGE: 25 Sets

18238

Screw only from 18239

UNIT PACKAGE: 50



18241

Black Nylon

M6-1.0 x 25mm
Slotted Pan Head

Head Diameter: 12mm (15/32")
Hex Width (ATF): 10mm (25/64")

UNIT PACKAGE: 25 Sets

18240

Screw only from 18241

UNIT PACKAGE: 50



16800

Nylon Screw, Spacer,
Washer & Brass Nut

M6-1.0 x 20mm
Slotted Pan Head License
Plate Screw & Hardware
Head Diameter: 12mm (15/32")
Hex Width (ATF): 10mm (25/64")
Washer O.D.: 12.5mm (1/2")
Spacer O.D.: 19mm (3/4")
Toyota

UNIT PACKAGE: 25 Sets



13466

(6032516)
Black Nylon

License Plate Nut
Screw Size: #12
Chrysler

UNIT PACKAGE: 25



17636

Nylon

License Plate Bracket Spacer

I.D.: 1/4" (6mm)
O.D.: 3/4" (19mm)
Thickness: 1/4" (6mm)
Toyota

UNIT PACKAGE: 50

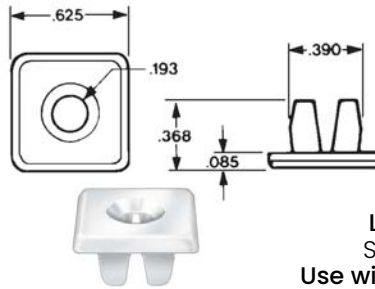

3682

(1196781)
Nylon

License Plate Nut
Screw Size: 1/4"-20
Use with Auveco Screw 5307
GM

UNIT PACKAGE: 50



2625

Nylon

License Plate Nut & Headlight Door Screw

Screw Size: #8
Mounting Screw Nut
Chrysler

UNIT PACKAGE: 100

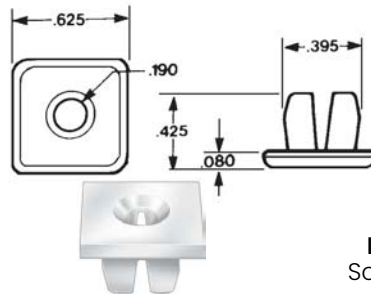

8435

(4755299)
Nylon

License Plate Nut
Screw Size: 1/4" (#14)
GM

UNIT PACKAGE: 50



23587

1747001
White Nylon

License Plate Nut
Screw Size: M3.5 (#6)
Head Size: 9.5mm
Fits into 7mm Sq. Hole
American Motors

UNIT PACKAGE: 100

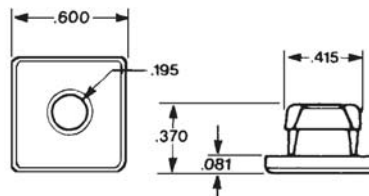

11719

(3907444)
Nylon

License Plate Nut
Screw Size: 1/4" (#14)
GM

UNIT PACKAGE: 50



5228

(3783006)
Nylon

License Plate Nut
Screw Size: #10
Use with Auveco Screw 5278
GM

UNIT PACKAGE: 50



20927

(N811478-S100)
Black Nylon

**License Plate & Rear Bumper
Nylon Nut with Sealer**
Screw Size: M6.3 (#14)
Head Size: 16mm x 16mm
Stem Length: 8mm
Ford Fusion & Mustang 2005 - On

UNIT PACKAGE: 15



11368

(380707-s)
Nylon

License Plate Nut
Screw Size: #14
Ford

UNIT PACKAGE: 50



8418

(380370)
Nylon

License Plate Nut
Screw Size: #14
Use with Auveco Screw 3089

GM

UNIT PACKAGE: 50



8954

Nylon

License Plate Nut
Screw Size: #14
Use with Auveco Screws 8249 or 8952

UNIT PACKAGE: 50



22372

(GM: 25832258)
Black Nylon

**Bumper, License Plate & Tail Light
Screw Grommet with Sealer**

Screw Size: #14 (1/4")
Head Size: 16mm x 16mm
Stem Length: 8mm
Fits into 10mm Square Hole
Buick Enclave, Cadillac CT6,
Chevrolet Traverse, GMC Acadia
& Saturn Outlook 2007 - On

UNIT PACKAGE: 10



19485

(6027958)
Natural Nylon

License Plate Nut
Screw Size: 1/4" (#14)
Chrysler

UNIT PACKAGE: 10



19317

(15707256)
Zinc Organic

**Front Fender Extension
& License Plate Bracket
Retainer Nut**

Screw Size: M6-1.0
GM Express &
Savanna 1996-On

UNIT PACKAGE: 10

CYLINDER HEAD AND MANIFOLD STUDS

Grade 8 Medium Carbon Heat Treated Alloy Steel

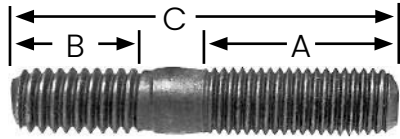

Auveco Part No.	A Diameter & Length	B Diameter & Length	C Overall Length	Unit Pkg.
9667	1/4"-28 SAE x 3/8"	1/4"-20 USS x 7/16"	1"	10
9668	1/4"-28 SAE x 1/2"	1/4"-20 USS x 1/2"	1-1/4"	10
9669	1/4"-28 SAE x 3/4"	1/4"-20 USS x 1/2"	1-1/2"	10
9670	1/4"-28 SAE x 1"	1/4"-20 USS x 1/2"	2"	10
9673	5/16"-24 SAE x 7/16"	5/16"-18 USS x 3/8"	1"	10
9674	5/16"-24 SAE x 5/8"	5/16"-18 USS x 1/2"	1-1/4"	10
9675	5/16"-24 SAE x 5/8"	5/16"-18 USS x 3/4"	1-1/2"	10
9676	5/16"-24 SAE x 7/8"	5/16"-18 USS x 9/16"	1-3/4"	10
9677	5/16"-24 SAE x 1"	5/16"-18 USS x 9/16"	2"	10
14824	5/16"-24 SAE x 1-5/8"	5/16"-18 USS x 1/2"	2-1/2"	10
9679	5/16"-18 USS x 7/8"	5/16"-18 USS x 7/16"	1-1/2"	10
24193	5/16"-18 USS x 15/16"	5/16"-18 USS x 1/2"	1-3/4"	25
9680	5/16"-18 USS x 1"	5/16"-18 USS x 7/16"	2"	10
9681	5/16"-24 SAE x 1-1/2"	5/16"-18 USS x 5/8"	3"	10
9683	3/8"-24 SAE x 3/4"	3/8"-16 USS x 1/2"	1-1/2"	10
9684	3/8"-24 SAE x 3/4"	3/8"-16 USS x 1/2"	1-3/4"	10
24049	3/8"-16 USS x 7/8"	3/8"-16 USS x 5/8"	1-3/4"	25
9686	3/8"-24 SAE x 1"	3/8"-16 USS x 5/8"	2"	10
9687	3/8"-16 USS x 1"	3/8"-16 USS x 3/4"	2"	10
9688	3/8"-16 USS x 1"	3/8"-16 USS x 5/8"	2-1/8"	10
14827*	3/8"-16 USS x 1-5/8"	3/8"-16 USS x 7/16"	2-7/32"	10
19597*	3/8"-16 USS x 1/2"	3/8"-16 USS x 1-7/8"	2-1/2"	10
12129	3/8"-16 USS x 5/8"	3/8"-16 USS x 2"	3"	10
9690	3/8"-24 SAE x 2"	3/8"-16 USS x 5/8"	3"	10
9692	3/8"-16 USS x 1-5/8"	3/8"-16 USS x 7/16"	3-1/4"	10
9695	3/8"-16 USS x 2"	3/8"-16 USS x 3/4"	4"	10
9699	7/16"-20 SAE x 3/4"	7/16"-14 USS x 9/16"	1-3/4"	10
24050	7/16"-14 SAE x 7/8"	7/16"-14 SAE x 3/4"	1-3/4"	25
9701	7/16"-20 SAE x 7/8"	7/16"-14 USS x 3/4"	2"	10
9702	7/16"-14 USS x 15/16"	7/16"-14 USS x 3/4"	2"	10
9705	7/16"-20 SAE x 3/4"	7/16"-14 USS x 3/4"	2-1/4"	10
9711	7/16"-14 USS x 1-1/4"	7/16"-14 USS x 3/4"	2-1/2"	10
9712	7/16"-20 SAE x 1-3/8"	7/16"-14 USS x 3/4"	2-1/2"	10
9715	7/16"-20 SAE x 1-13/16"	7/16"-14 USS x 3/4"	3"	10
9727	1/2"-20 SAE x 3/4"	1/2"-13 USS x 3/4"	1-7/8"	10
9728	1/2"-20 SAE x 15/16"	1/2"-13 USS x 13/16"	2"	10
9729	1/2"-20 SAE x 1"	1/2"-13 USS x 3/4"	2-1/4"	10
9731	1/2"-20 SAE x 1"	1/2"-13 USS x 3/4"	2-1/2"	10
9739	9/16"-18 SAE x 1-1/4"	9/16"-12 USS x 1"	3"	10
9744	5/8"-11USS x 1-1/2"	5/8"-11 USS x 13/16"	2-3/4"	10
9745	5/8"-18 SAE x 1-1/4"	5/8"-11 USS x 1"	3"	10
24051	3/4"-10 USS x 1-11/16"	3/4"-10 USS x 1-1/16"	2-13/16"	25

* With Dog Point

CYLINDER HEAD AND MANIFOLD STUDS

Grade 8 Medium Carbon Heat Treated Alloy Steel

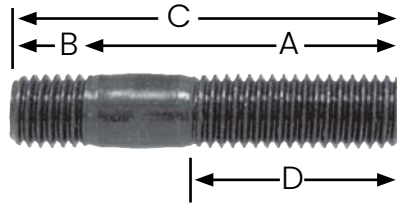

Auveco Part No.	A Diameter & Length	B Diameter & Length	C Overall Length	D Length	Unit Pkg.
11973	6mm-1.00 x 20mm	6mm-1.00 x 7.5mm	27.5mm	18mm	10
11974	6mm-1.00 x 25mm	6mm-1.00 x 7.5mm	32.5mm	18mm	10
11980	8mm-1.25 x 20mm	8mm-1.25 x 10mm	30.0mm	16mm	10
11981	8mm-1.25 x 25mm	8mm-1.25 x 10mm	35.0mm	22mm	10
11982	8mm-1.25 x 30mm	8mm-1.25 x 10mm	40.0mm	22mm	10
11983	8mm-1.25 x 35mm	8mm-1.25 x 10mm	45.0mm	22mm	10
11984	8mm-1.25 x 40mm	8mm-1.25 x 10mm	50.0mm	22mm	10
11987	8mm-1.25 x 55mm	8mm-1.25 x 10mm	65.0mm	22mm	10
11989	10mm-1.50 x 30mm	10mm-1.50 x 12mm	42.0mm	18mm	10
11990	10mm-1.50 x 35mm	10mm-1.50 x 12mm	47.0mm	26mm	10
11991	10mm-1.50 x 40mm	10mm-1.50 x 12mm	52.0mm	26mm	10
11995	10mm-1.50 x 65mm	10mm-1.50 x 12mm	77.0mm	26mm	5
11998	12mm-1.75 x 30mm	12mm-1.75 x 15mm	45.0mm	25mm	5

11404 (N14-4003) Plain



M8-1.25 x 35mm
Class 4.8
Volkswagen Intake Manifold

UNIT PACKAGE: 25

17559

Yellow Zinc Dichromate



M10-1.25 x 42mm
Class 8.8
Exhaust Systems
Honda, Nissan & Toyota

UNIT PACKAGE: 10

WARNING: Reproductive Harm & Cancer
www.P65Warnings.ca.gov

17560

Yellow Zinc Dichromate

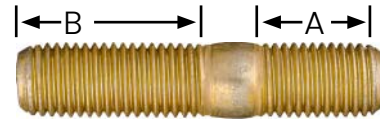

M10-1.25 x 48mm
Dim. A: 15mm; Dim. B: 25mm
Class 8.8
Exhaust Systems
Honda, Nissan & Toyota

UNIT PACKAGE: 10

WARNING: Reproductive Harm & Cancer
www.P65Warnings.ca.gov

17596

Yellow Zinc Dichromate



M12-1.25 x 50mm
Class 8.8
Catalytic Converter
Mazda

UNIT PACKAGE: 5

WARNING: Reproductive Harm & Cancer
www.P65Warnings.ca.gov



**Phillips Pan Head
Metric Machine Screws**
DIN 7985
Regular Pitch • Zinc Plated

Auveco Part No.	Diameter & Pitch	Length	Unit Pkg.
15867	4mm-.70	8mm	100
15868	4mm-.70	10mm	100
15869	4mm-.70	16mm	100
15870	5mm-.80	8mm	100
15871	5mm-.80	10mm	100
15872	5mm-.80	12mm	100
15873	5mm-.80	16mm	100
15874	5mm-.80	20mm	100
15875	5mm-.80	25mm	100
15876	6mm-1.00	10mm	100
15877	6mm-1.00	12mm	100
15878	6mm-1.00	16mm	50
15879	6mm-1.00	20mm	50
15880	6mm-1.00	25mm	50
15881	6mm-1.00	30mm	50



**Phillips Pan Head
License Plate Screws**
Regular Pitch • Stainless Steel

Auveco Part No.	Size	Head Diameter	Unit Pkg.
25239	M6-1.0 x 8mm	11.8mm	25
22888	M6-1.0 x 12mm	11.8mm	25
24471	M6-1.0 x 16mm	11.8mm	25



**Slotted Flat Fillister Head
Metric Machine Screws**
DIN 84
Regular Pitch • Zinc Plated

Auveco Part No.	Diameter & Pitch	Length	Unit Pkg.
10459	5mm-.80	16mm	25
10460	5mm-.80	20mm	25
14396	6mm-1.00	10mm	100



**Slotted Pan Head
Metric Machine Screws**
DIN 85
Regular Pitch • Zinc Plated

Auveco Part No.	Diameter & Pitch	Length	Unit Pkg.
10427	4mm-.70	10mm	25
10431	5mm-.80	12mm	25
10437	6mm-1.00	12mm	25
14392	6mm-1.00	12mm	100
10438	6mm-1.00	16mm	25
14393	6mm-1.00	16mm	100
10440	6mm-1.00	20mm	25
14395	6mm-1.00	20mm	100
10441	6mm-1.00	25mm	25



**Phillips Oval Head
Metric Machine Screws**
DIN 966
Regular Pitch • Zinc Plated

Auveco Part No.	Diameter & Pitch	Length	Unit Pkg.
15888	5mm-.80	12mm	100
15890	5mm-.80	20mm	100
15893	6mm-1.00	12mm	100
15895	6mm-1.00	20mm	50
15896	6mm-1.00	25mm	50

**Slotted Flat Head Metric Machine
Screws**



DIN 963 (Medium Head)
Regular Pitch • Zinc Plated

Auveco Part No.	Diameter & Pitch	Length	Unit Pkg.
10478	4mm-.70	8mm	25



Regular Pitch Metric Hex Head Cap Screws

DIN 931 & DIN 933
Fully Threaded • 8.8 Heat Treated Alloy Steel • Zinc Plated
Tensile Strength: 116,000 PSI

Auveco Part No.	Diameter & Pitch	Length	Unit Pkg.
4mm (7mm Hex)			
14581	4mm-.7	12mm	50
10501	4mm-.7	16mm	25
14400	4mm-.7	16mm	50
10502	4mm-.7	20mm	25
14401	4mm-.7	20mm	50
14582	4mm-.7	25mm	50
5mm (8mm Hex)			
10504	5mm-.8	10mm	25
14402	5mm-.8	10mm	50
14583	5mm-.8	12mm	50
10505	5mm-.8	16mm	25
14403	5mm-.8	16mm	50
10506	5mm-.8	20mm	25
14404	5mm-.8	20mm	50
10507	5mm-.8	25mm	25
14405	5mm-.8	25mm	50
10508	5mm-.8	30mm	10
14406	5mm-.8	30mm	25
15512	5mm-.8	40mm	50
6mm (10mm Hex)			
14584	6mm-1.00	10mm	50
10509	6mm-1.00	12mm	25
14407	6mm-1.00	12mm	50
16697	6mm-1.00	12mm	100
10510	6mm-1.00	16mm	10
14408	6mm-1.00	16mm	25
16698	6mm-1.00	16mm	100
10511	6mm-1.00	20mm	10
14409	6mm-1.00	20mm	25
16699	6mm-1.00	20mm	100
10512	6mm-1.00	25mm	10
14410	6mm-1.00	25mm	25
16700	6mm-1.00	25mm	100
10513*	6mm-1.00	30mm	10
14411*	6mm-1.00	30mm	25
16701*	6mm-1.00	30mm	100
10514*	6mm-1.00	35mm	10
14412*	6mm-1.00	35mm	25
10515*	6mm-1.00	40mm	10
14413*	6mm-1.00	40mm	25
10516*	6mm-1.00	45mm	10
14414*	6mm-1.00	45mm	25
14585*	6mm-1.00	50mm	25
15514*	6mm-1.00	60mm	25
7mm (11mm Hex)			
10517	7mm-1.00	16mm	10
14415	7mm-1.00	16mm	25
10519	7mm-1.00	25mm	10
14417	7mm-1.00	25mm	25
10520	7mm-1.00	30mm	10
14418	7mm-1.00	30mm	25
14587	7mm-1.00	40mm	25

Auveco Part No.	Diameter & Pitch	Length	Unit Pkg.
8mm (13mm Hex)			
14588	8mm-1.25	12mm	25
10521	8mm-1.25	16mm	10
14419	8mm-1.25	16mm	25
16702	8mm-1.25	16mm	50
10522	8mm-1.25	20mm	10
14420	8mm-1.25	20mm	25
16703	8mm-1.25	20mm	50
10523	8mm-1.25	25mm	10
14421	8mm-1.25	25mm	25
10524	8mm-1.25	30mm	10
14422	8mm-1.25	30mm	25
16705	8mm-1.25	30mm	50
10525*	8mm-1.25	35mm	10
14423*	8mm-1.25	35mm	25
16706*	8mm-1.25	35mm	50
10526*	8mm-1.25	40mm	10
14424*	8mm-1.25	40mm	25
16707*	8mm-1.25	40mm	50
10527*	8mm-1.25	45mm	10
14425*	8mm-1.25	45mm	25
10528*	8mm-1.25	50mm	10
14426*	8mm-1.25	50mm	25
10529*	8mm-1.25	55mm	10
14427*	8mm-1.25	55mm	25
10530*	8mm-1.25	60mm	10
14428*	8mm-1.25	60mm	25
10532	8mm-1.25	70mm	5
14429	8mm-1.25	70mm	10
14589*	8mm-1.25	75mm	10
17399*	8mm-1.25	80mm	15
17400*	8mm-1.25	90mm	15
17401*	8mm-1.25	100mm	10
10mm (17mm Hex)			
10534	10mm-1.50	20mm	10
14430	10mm-1.50	20mm	25
16708	10mm-1.50	20mm	50
10535	10mm-1.50	25mm	10
14431	10mm-1.50	25mm	25
16709	10mm-1.50	25mm	50
10536	10mm-1.50	30mm	10
14432	10mm-1.50	30mm	25
16710	10mm-1.50	30mm	50
10537	10mm-1.50	35mm	5
14433	10mm-1.50	35mm	15
16711	10mm-1.50	35mm	25
10538	10mm-1.50	40mm	5
14434	10mm-1.50	40mm	15
16712	10mm-1.50	40mm	25
10539	10mm-1.50	45mm	5
14435	10mm-1.50	45mm	15
10540	10mm-1.50	50mm	5
14436	10mm-1.50	50mm	15
16713*	10mm-1.50	50mm	25

(Continued on next page)



Regular Pitch Metric Hex Head Cap Screws

DIN 931 & DIN 933

Fully Threaded • 8.8 Heat Treated Alloy Steel • Zinc Plated
Tensile Strength: 116,000 PSI

Auveco Part No.	Diameter & Pitch	Length	Unit Pkg.	Auveco Part No.	Diameter & Pitch	Length	Unit Pkg.
10mm (17mm Hex) Continued				12mm (19mm Hex) Continued			
10541*	10mm-1.50	55mm	5	14444*	12mm-1.75	45mm	10
14437*	10mm-1.50	55mm	10	10549*	12mm-1.75	50mm	5
10542*	10mm-1.50	60mm	5	14445*	12mm-1.75	50mm	10
14438*	10mm-1.50	60mm	10	10550*	12mm-1.75	60mm	5
16714*	10mm-1.50	60mm	25	14446*	12mm-1.75	60mm	10
10543*	10mm-1.50	70mm	5	10551*	12mm-1.75	70mm	5
14439*	10mm-1.50	70mm	10	14447*	12mm-1.75	70mm	10
15516*	10mm-1.50	90mm	10	17403*	12mm-1.75	80mm	10
15517*	10mm-1.50	100mm	10	17404*	12mm-1.75	90mm	10
12mm (19mm Hex)				14mm (22mm Hex)			
10544	12mm-1.75	25mm	5	14590	14mm-2.0	30mm	10
14440	12mm-1.75	25mm	10	14591	14mm-2.0	40mm	10
16715	12mm-1.75	25mm	25	14592	14mm-2.0	50mm	10
10545	12mm-1.75	30mm	5	16mm (24mm Hex)			
14441	12mm-1.75	30mm	10	14595	16mm-2.0	30mm	5
16716	12mm-1.75	30mm	25	*DIN 931 - Not Fully Threaded			
10546	12mm-1.75	35mm	5				
14442	12mm-1.75	35mm	10				
16717	12mm-1.75	35mm	25				
10547	12mm-1.75	40mm	5				
14443	12mm-1.75	40mm	10				
16718	12mm-1.75	40mm	25				
10548*	12mm-1.75	45mm	5				

J.I.S Small Head Cap Screws

J.I.S. B 1180 • I.S.O. Class 8.8

Heat Treated • Steel • Zinc Plated

J.I.S. fasteners have a smaller hex dimension (across the flats) than DIN or ISO metric fasteners. They fit in those tight spots where the hex of an ISO or DIN fastener is too large. J.I.S. fasteners are OEM equipment on many GM and Japanese import car applications.

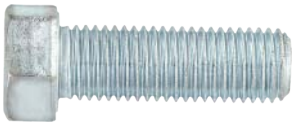

Auveco Part No.	Diameter & Pitch	Length	Unit Pkg.	Auveco Part No.	Diameter & Pitch	Length	Unit Pkg.
M8-1.25 (12mm Hex)				M12-1.25 (17mm Hex)			
14777	8mm-1.25	16mm	25	16609	12mm-1.25	20mm	10
14778	8mm-1.25	20mm	25	16610	12mm-1.25	25mm	10
14779	8mm-1.25	25mm	25	16611	12mm-1.25	30mm	10
14780	8mm-1.25	30mm	25	16612	12mm-1.25	35mm	10
14781	8mm-1.25	35mm	25	16613	12mm-1.25	40mm	10
14782	8mm-1.25	40mm	25	16614	12mm-1.25	50mm	10
14784	8mm-1.25	50mm	25				
M10-1.25 (14mm Hex)							
14787	10mm-1.25	20mm	25				
14788	10mm-1.25	25mm	25				
14789	10mm-1.25	30mm	25				
14790	10mm-1.25	35mm	15				
14791	10mm-1.25	40mm	15				
14792	10mm-1.25	45mm	15				
14793	10mm-1.25	50mm	15				
14794	10mm-1.25	60mm	10				



Fine Pitch Metric Hex Head Cap Screws
DIN 960 & DIN 961

Fully Threaded
8.8 Heat Treated Alloy Steel • Black Finish
Tensile Strength: 116,000 PSI

Auveco Part No.	Diameter & Pitch	Length	Unit Pkg.
8mm (13mm Hex)			
11255	8mm-1.00	10mm	10
11259	8mm-1.00	40mm	10
14604*	8mm-1.00	50mm	25
10mm (17mm Hex)			
11262	10mm-1.00	30mm	10
11263	10mm-1.00	40mm	10
14605	10mm-1.25	20mm	10
11265	10mm-1.25	25mm	10
11266	10mm-1.25	30mm	10
11267	10mm-1.25	35mm	10
11268	10mm-1.25	40mm	10
11269	10mm-1.25	50mm	10
14606*	10mm-1.25	60mm	10
12mm (19mm Hex)			
11270	12mm-1.25	25mm	10
14607	12mm-1.25	30mm	5
11271	12mm-1.25	35mm	5
14608	12mm-1.25	40mm	5
14610*	12mm-1.25	70mm	5
11273	12mm-1.50	20mm	10
11274	12mm-1.50	30mm	10
11275	12mm-1.50	40mm	5
11276	12mm-1.50	50mm	5
14mm (22mm Hex)			
14611	14mm-1.50	30mm	5
14612	14mm-1.50	40mm	5
14613	14mm-1.50	50mm	5
24048	14mm-2.00	80mm	5
16mm (24mm Hex)			
14617	16mm-1.50	40mm	5

*DIN 931 - Not Fully Threaded



Metric Hex Socket Head Cap Screw
DIN 912

Regular Pitch - Grade 12.9
Heat Treated Alloy Steel • Plain Finish
Tensile Strength: 177,000 PSI

Auveco Part No.		Diameter & Pitch	Length
Unit Package	100		
10845	10872	4mm-.7	12mm
10846		5mm-.8	12mm
10848	10875	5mm-.8	20mm
10851		6mm-1.00	16mm
10854		6mm-1.00	30mm
10855		8mm-1.25	16mm
10858		8mm-1.25	30mm
10861		10mm-1.50	20mm
10864		10mm-1.50	40mm
10865		10mm-1.50	50mm
10866		12mm-1.75	30mm
10868		12mm-1.75	40mm
10870		12mm-1.75	60mm



Metric Flat Head Socket Cap Screws
DIN 7991

Regular Pitch - Grade 10.9
Heat Treated Alloy Steel • Plain Finish
Tensile Strength 150,800 PSI

Auveco Part No.		Diameter & Pitch	Length
Unit Package	100		
10960	10961	6mm-1.00	16mm
10972		8mm-1.25	25mm



Metric Hex Key
Plain Finish

Use with Din 912 & Din 7991

Auveco Part No.	Hex Size	For Screw Size	Unit Pkg.
7965	3mm	4mm	10



**Metric Socket Set
Screws - Cup Point**
DIN 916

Regular Pitch - Grade 12.9
Heat Treated Alloy Steel • Plain Finish

Auveco Part No.	Diameter & Pitch	Length	Unit Pkg.
11024	8mm-1.25	20mm	10
11032	10mm-1.50	20mm	10



**Torx® Round Washer
Head Body Bolts**
CA Point • Plated

Auveco Part No.	Size	Finish	Washer Head Dia.	Torx Drive	Unit Pkg.
15807	M6-1.0 x 25mm	Zinc	18mm	T-30	50



**Hex Head Sems® Body
Bolts for Import Cars**

Class 8.8 • Yellow Zinc Dichromate Plated

Auveco Part No.	Size	Hex Size	Washer O.D.	Unit Pkg.
20434	M6-1.0 x 12mm	10mm	12.5mm	50
18177 ⚠	M6-1.0 x 16mm	10mm	12.5mm	50

⚠ **WARNING:** Reproductive Harm & Cancer
www.P65Warnings.ca.gov



J.I.S. Small Head Hex Flange Bolts

J.I.S. B1189 • I.S.O. Class 10.9 • Zinc Plated
10mm Bolts are used with Auveco Hex Flange Nut 16470
on Import Car Exhaust Systems

Auveco Part No.	Size	Hex Size	Flange O.D.	Unit Pkg.
17315	M6-1.0 x 12mm	10mm	14mm	50
17316	M6-1.0 x 16mm	10mm	14mm	50
18807	M6-1.0 x 20mm	10mm	14mm	50
21048	M6-1.0 x 25mm	10mm	14mm	25
18808	M6-1.0 x 30mm	10mm	14mm	25
21049	M6-1.0 x 35mm	10mm	14mm	25
18809	M6-1.0 x 40mm	10mm	14mm	25
21050	M6-1.0 x 45mm	10mm	14mm	25
18980	M8-1.25 x 12mm	12mm	17.5mm	25
17387	M8-1.25 x 16mm	12mm	17.5mm	15
17388	M8-1.25 x 20mm	12mm	17.5mm	15
21051	M8-1.25 x 25mm	12mm	17.5mm	15
17389	M8-1.25 x 30mm	12mm	17.5mm	15
21052	M8-1.25 x 35mm	12mm	17.5mm	15
17390	M8-1.25 x 40mm	12mm	17.5mm	15
21053	M8-1.25 x 45mm	12mm	17.5mm	15
17188	M10-1.25 x 16mm	14mm	20mm	10
17189	M10-1.25 x 20mm	14mm	20mm	10
21054	M10-1.25 x 25mm	14mm	20mm	10
17190	M10-1.25 x 30mm	14mm	20mm	10
21055	M10-1.25 x 35mm	14mm	20mm	10
17191	M10-1.25 x 40mm	14mm	20mm	10
21056	M10-1.25 x 45mm	14mm	20mm	10



Metric Body Bolt Specification Chart



Auveco Part No.	Size	Length	Hex Size	Washer/ Head O.D.	Type	Point Type	Finish	Unit Pkg.	Page No.
23900	M4	12mm		5.5mm	Hex Head Sems	B	Yellow Zinc	50	83
22164	M4-7	16mm	7mm	13mm	Hex Head Sems®	Dog Pt	Phosphate	50	83
25439	M5-0.8	15mm		12mm ²	Square Head Stud	Dog Pt	Zinc	25	83
12232	M5-0.8	20mm	8mm	12mm	Hex Head Sems	Dog Pt	Phosphate	50	83
23801	M5	20mm	8mm	14mm	Hex Head Sems	B	Black	50	83
22271	M5-0.8	23mm	8mm	18mm	Phillips Hex Head Sems	Dog Pt	Zinc	50	83
24479	M5	25mm	8mm	14.5mm	Indented Hex Head	Dog Pt	Black Steel	25	83
21840	M6-1.0	11mm	10mm	15.5mm	Hex Head Flange	C	Black E-Coat	25	83
20434	M6-1.0	12mm	10mm	12.5mm	Hex Head Sems	C	Yellow Zinc Dichromate	50	79
22293	M6-1.0	15mm	10mm	18mm	Hex Washer Head Sems		Black Phos.	25	83
23830	M6	16mm	10mm	16mm	Hex Head Sems	B	Black	50	84
15791	M6-1.0	16mm	10mm	17mm	Hex Head Sems	C	Black Fluorocarbon	50	84
12064	M6-1.0	16mm	10mm	18.5mm	Hex Head Sems	B	Yellow Zinc	50	84
23688	M6-1.0	18mm	8mm	19mm	Hex Head Sems	Dog Pt	Phosphate	50	84
18515	M6-1.0	20mm	T-30 Drive	13.5mm	Torx® Washer Head	Dog Pt.	Black Organic	25	84
23789	M6-1.0	20mm	T-30	18mm	Torx Washer Head	CA	Zinc	50	84
12324	M6-1.0	20mm	10mm	13mm	Hex Washer Head	CA	Blk Phos.	50	84
16826	M6-1.0	20mm	10mm	13mm	Slotted Hex Washer Head	CA	Zinc	50	84
24489	M6-1.0	20mm	T-30	16mm	Torx Washer Head	CA	Black Steel	25	84
12322	M6-1.0	20mm	10mm	17mm	Hex Head Sems	C	Phos.	25	84
12693	M6-1.0	20mm	10mm	17mm	Hex Head Sems	CA	Phos.	25	84
12067	M6-1.0	20mm	10mm	17mm	Hex Head Sems	C	Phos.	50	85
13617	M6-1.0	20mm	10mm	24mm	Hex Head Sems	CA	Phos.	50	85
23811	M6-1.0	20mm	T-30	24mm	Hex Head Sems	Dog Pt	Phosphate	50	85
22536	M6-1.0	20mm	10mm	24mm	Hex Head Sems		Black Zinc	15	85
23855	M6-1.0	20mm	T-30	18mm	Torx Button Head	Dog Pt	Black	15	85
12160	M6-1.0	22mm	8mm	19mm	High Hex Head Sems	Dog Pt	Phos.	25	85
22428	M6-1.0	22mm	T-30	17.5mm	Pan Head Torx	Dog Pt	Black Zinc	15	85
15778	M6-1.0	22.5mm	8mm	19mm	Hex Head Sems	Dog Pt	Zinc	50	85
15807	M6-1.0	25mm	T-30	18mm	Torx Round Washer Head Drive	CA	Zinc	50	81
23689	M6	25mm	10mm	17mm	Hex Head Sems	B	Black	50	86
12065	M6-1.0	25mm	10mm	17mm	Hex Head Sems	CA	Phos.	50	86
15788	M6-1.0	25mm	10mm	17mm	Hex Head Sems	CA	Zinc	50	86
19455	M6-1.0	25mm	10mm	19mm	Hex Head Sems	Dog Pt	Phos.	25	86
12066	M6-1.0	25mm	10mm	24mm	Hex Head Sems	CA	Phos	50	86
12323	M6-1.0	25mm	10mm	24mm	Hex Head Sems	CA	Blk Polyseal	25	86
14947	M6-1.0	26mm	T-30 Drive	16mm	Pan Head Torx Sems	Dog Pt	Stainless Steel	25	86
23808	M6-1.0	28mm	8mm	19mm	Hex Head Sems	Dog Pt	Phosphate	25	86
15779	M6-1.0	28mm	8mm	19mm	Hex Head Sems	Dog Pt	Blk Zinc Phos.	50	86
12335	M6-1.0	28mm	8mm	19mm	Hex Head Sems	Dog Pt	Yellow Zinc	25	86
16893	M6-1.0	28mm	8mm	25mm	Hex Head Sems	Dog Pt	Phos.	25	86
22232	M6-1.0	30mm	10mm	18mm	Hex Head Sems w/ Lock Patch	Dog Pt	Black Zinc	25	87

⚠️WARNING: Reproductive Harm & Cancer www.P65Warnings.ca.gov



Metric Body Bolt Specification Chart

Auveco Part No.	Size	Length	Hex Size	Washer/ Head O.D.	Type	Point Type	Finish	Unit Pkg.	Page No.
15818	M6-1.0	30mm	10mm	19mm	Hex Head Sems	Dog Pt	Phos.	50	87
20261	M6-1.0	30mm	10mm	20mm	Hex Head Sems	CA	Phos.	25	87
13618	M6-1.0	30mm	10mm	24mm	Hex Head Sems	CA	Phos.	50	87
18416	M6-1.0	35mm	10mm	17mm	Hex Head Sems	CA	Blk Phos.	50	87
22906	M6-1.0	40mm	10mm	20mm	Hex Head Sems	Dog	Zinc	10	87
11633	M6.3-1.0	20mm	10mm	17mm	Hex Head Sems	CA	Phos.	25	87
23654	M6.3	20mm	10mm	13mm	Hex Head Sems	CA	Black	50	87
11935	M6.3-1.0	25mm	10mm	17mm	Hex Head Sems	CA	Zinc	25	87
23661	M6.3	25mm	10mm	18mm	Hex Head Sems	CA	Phos.	100	87
11638	M8-1.25	16mm	13mm	18mm	Hex Washer Head with Serrations Under the Head	Dog Pt	Phos	25	87
23653	M8-1.25	20mm	13mm	16mm	Body Bolt	CA	Black	50	87
24500	M8-1.25	23mm	13mm	20mm	Body Bolt	Dog Pt	Zinc	25	88
12336	M8-1.25	25mm	13mm	17mm	Hex Washer Head	CA	Phos.	25	88
15790	M8-1.25	25mm	13mm	17mm	Hex Head Sems	CA	Phos.	50	88
11639	M8-1.25	25mm	13mm	17mm	Hex Washer Head	C	Phos.	25	88
13613	M8-1.25	25mm	13mm	24mm	Hex Head Sems	CA	Phos.	25	88
23817	M8-1.25	25mm	10mm	22mm	Hex Head Sems	Dog Pt	Phosphate	25	89
12348	M8-1.25	30mm	13mm	17mm	Hex Washer Head	CA	Phos.	25	88
11640	M8-1.25	30mm	13mm	17mm	Hex Washer Head	CA	Zinc Organic	25	88
13614	M8-1.25	30mm	13mm	24mm	Hex Head Sems	CA	Phos.	25	88
22908	M8-1.25	30mm	13mm	24mm	Hex Head Sems	Dog	Zinc	5	88
22915	M8-1.25	31mm	13mm	24mm	Washer Head Sems	Dog	Zinc	10	88
15780	M8-1.25	33mm	10mm	22mm	Hex Head Sems	Dog Pt	Phos.	50	88
12343	M8-1.25	35mm	13mm	17mm	Hex Washer Head	CA	Phos.	25	89
24502	M8-1.25	35mm	13mm	17.5mm	Hex Flange Head	Dog Pt	Steel	15	89
13705	M8-1.25	35mm	13mm	24mm	Hex Head Sems	CA	Phos.	25	89
23796	M8-1.25	40mm	13mm	17mm	Hex Washer w/ Lock Patch	CA	Black	50	89
16931	M8-1.25	42mm	10mm	22mm	Hex Head Sems	Dog Pt	Phos.	25	89
13619	M10-1.50	30mm	15mm	29mm	Hex Head Sems	CA	Phos.	10	89
23711	M10-1.50	30mm	13mm	25mm	Hex Flange	CA	Black	25	89
12327	M10-1.50	33mm	13mm	20mm	Hex Washer Head	Dog Pt	Phos.	25	89
11641	M10-1.50	40mm	15mm	29mm	Hex Head Sems	CA	Phos.	25	89

WARNING: Reproductive Harm & Cancer www.P65Warnings.ca.gov

Photos not actual size

THE PROBLEM

Original bolts & nuts are difficult to remove due to rust and the type of threading used at the factory. Ford uses self-threading tri-lobular bolts called TAPTITE2000®. The bolts are driven down into a nut plate attached to the frame that is not threaded. Once the bolts and nuts rust/oxidize they are nearly impossible to remove and often need to be cut off.

THE SOLUTION

Auveco's replacement bolt and nuts.

Standard threaded bolt and mating nut do not require the need of special tools. Bolts follow the head and shaft contours of the O.E. bolt which allow them to duplicate the original fit & function.

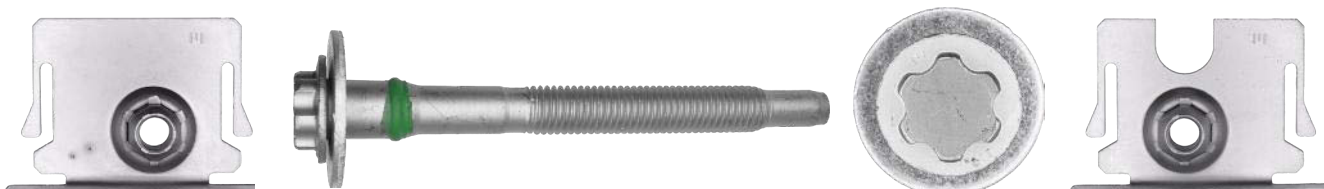

R.H. Side

Truck Bed Mounting Torx® Plus Flange Head Sems® Body Bolts with Dog Point and Zinc Finish

L.H. Side

Problem solving Bed Bolts and Nut Plates for Ford F250SD & F350SD 2017 - On. Use with Auveco Nut Plates 25310 & 25311.

Auveco Part No.	Size	Flange Diameter	Washer Outer Diameter	Drive Size	OEM Number	Unit Pkg.
25312	M14-2.0 x 148MM	29MM	42MM	EP24 Torx® Plus	W718818-S902	2
25313	M14-2.0 x 130MM	29MM	42MM	EP24 Torx® Plus	W719365-S902	2

Truck Bed Mounting Nut Plates with Zinc Finish

Auveco Part No.	Description	Overall Size	Overall Width	Length	OEM Number	Pkg.
25310	Left-Hand Side	M14-2.0	68MM	104MM	W718477-S439	2
25311	Right-Hand Side	M14-2.0	68MM	104MM	W718478-S439	2



Truck Bed Mounting Button Head Sems® Body Bolts with Zinc Finish

Problem solving Bed Bolts and U-Nuts for Ford F250SD, F350SD, F450SD, F550SD 2016 - 1999. Use with Auveco U-Nut 25041.

Auveco Part No.	Size	Washer Outer Diameter	Shoulder Length Under Sems	Drive Size	OEM Number	Unit Pkg.
25042	M14-2.0 x 138MM	40MM	23MM	8MM Allen	W714262-S902	2
25043	M14-2.0 x 138MM	40MM	19.5MM	8MM Allen	W714263-S902	2
25044	M14-2.0 x 108MM	40MM	23MM	8MM Allen	W714264-S902	2

Truck Bed Mounting U-Nut with Zinc Finish

Auveco Part No.	Size	Screw Range	Panel Hole to Edge	OEM Number	Unit Pkg.
25041	M14-2.0	4MM	45MM	W708770-S436	5

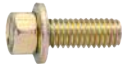

23900
(N801293S36)
Yellow Zinc
M4-.7 x 12mm
Hex Head Sems*
Washer Diameter: 7.9mm
Across Flats: 5.5mm
Class: 9

UNIT PACKAGE: 50



22164
(GM: 11502618)
Phosphate
M4-.7 x 16mm
Hex Head Sems* with Dog Point
Washer Diameter: 13mm
Hex: 7mm
GM

UNIT PACKAGE: 50



25439
(Chrysler: 68353367AA)
Zinc Inorganic
Bumper & Grille Square Head Stud with Dog Point
Size: M5-0.8 X 15mm
Head Size: 12mm x 12mm
Jeep Gladiator 2020 - On;
RAM 1500, 2500, 3500 2019 - On

UNIT PACKAGE: 25



12232
(6100539)
Phosphate
M5-0.8 x 20mm
Hex Head Sems*
Thread Cutting Screw with Dog Point
Outer Diameter Washer: 12mm (1/2")
Hex: 8mm
Chrysler

UNIT PACKAGE: 50



23801
(11505816)
Black Phosphate
M5-0.8 x 20mm
Hex Head Sems*
Washer Head Diameter: 14mm
Across Flats: 8mm
Class: 9.8

UNIT PACKAGE: 50



22271
(Subaru: 901935002)
Black Zinc
M5-0.8 x 23mm
Phillips Hex Head Sems* Body Bolt with Dog Point
Washer Diameter: 18mm
Hex Size: 8mm
Use with Auveco 22175
Subaru Forester & Legacy 1995 - On

UNIT PACKAGE: 50



24479
(W505416)
Black Steel
M5 x 25
Indented Hex Head Dog Point
Thread Pitch: 0.8
Across Flats: 8mm
Washer Diameter: 14.5mm
Ford & Universal
UNIT PACKAGE: 25



22942
(Acura & Honda: 90111-SM4-003)
Black
Bumper Bolt
Size: M6 - 1.0 x 8mm
Shoulder Diameter: 9mm
Shoulder Length: 6.5mm
Washer Outer Diameter: 18mm
Hex: 10mm
Hex Height: 7mm
Acura CL 2003 - 1997; ILX 2019 - 2013;
Integra 2001 - 1986; Legend 1995 - 1987;
MDX 2019 - 2014; NSX 2005 - 1991; RDX 2019 - 2007;
RL 2012 - 2009; RLX 2019 - 2014; RSX 2004 - 2002;
TL 2014 - 1996; TLX 2019 - 2015; TSX 2014 - 2004;
Vigor 1994 - 1992; ZDX 2013 - 2010
Honda Accord 2020 - 1990; Civic 2020 - 1984;
CR-V 2020 - 1997; CR-Z 2016 - 2011;
Crosstour 2015 - 2010; CRX 1991 - 1984;
Element 2008 - 2007; Fit 2020 - 2007;
Insight 2020 - 2000; Odyssey 2020 - 1995;
Passport 2020 - 2019; Pilot 2020 - 2012;
Prelude 2001 - 1992; Ridgeline 2020 - 2006

UNIT PACKAGE: 15



22941
(Acura & Honda: 90101-TR0-000)
Silver

Engine Cover Phillips Drive Bolt
Size: M6 - 1.0 x 8.5mm
Shoulder Diameter: 10mm
Shoulder Length: 4.5mm
Head Diameter: 18mm
Acura ILX 2015 - 2013
Honda Civic 2015 - 2012

UNIT PACKAGE: 15



21840
(Toyota: 90105-06037)
Black E-Coat
M6-1.0 x 11mm
Hex Head Flange
Flange Outer Diameter: 15.5mm
Hex: 10mm
Luggage Compartment Door & Lock and Radiator Grille
Toyota & Lexus 2001 - On

UNIT PACKAGE: 25



22293
(Mazda: 9GG600616T)
Black Phosphate
M6-1.0 x 15mm
Hex Washer Head Sems*
Washer Outer Diameter: 18mm
Hex: 10mm
Fender Liner
Mazda 1996 - On
UNIT PACKAGE: 25



25224
 (Honda: 90105-TBA-A00)
 Zinc Finish
Engine Cover Phillips Drive Bolt
 M6-1.0 x 15mm
 Head Diameter: 18mm
 Shoulder Diameter: 10mm
 Shoulder Length: 2.5mm
 Drive: #3 Phillips
 Honda CR-V 2017 - On, Civic 2016 - On,
 Insight 2019 - On
UNIT PACKAGE: 15



15791
 (11508930)
 Black Fluorocarbon
 M6-1.0 x 16mm
Hex Head Sems*
 Class 9.8
 Washer Outer Diameter: 17mm (21/32")
 Hex: 10mm
 GM
UNIT PACKAGE: 50



23830
 Black
 M6-1.0 x 16mm
Hex Head Sems*
 Class 9.8
 Washer Outer Diameter: 16mm
 Across Flats: 10mm
UNIT PACKAGE: 50



12064
 (11503812)
 Yellow Zinc
 M6-1.0 x 16mm
Hex Head Sems*
 Class 9.8
 Washer Outer Diameter: 18.5mm (47/64")
 Hex: 10mm
 GM
UNIT PACKAGE: 50



23688
 (N606675-S2)
 Black
 M6-1.0 x 18mm
Hex Head Sems* with Dog Point
 Class 9.8
 Washer Diameter: 19mm (3/4")
 Across Flats: 8mm
 Hex Size: 8mm
UNIT PACKAGE: 50



18515
 (21094240)
 Black
 500 Hour Salt Spray
 M6-1.0 x 20mm
Torx* Washer Head with Dog Point & Sealant on Threads
 T-30 Drive
 Washer Head Outer Diameter: 13.5
 Front & Rear Door Lock
 GM Saturn
UNIT PACKAGE: 25



12324
 (11503800)
 Phosphate
 M6-1.0 x 20mm
Hex Washer Head
 Class 9.8
 Washer Head Outer Diameter: 13mm (1/2")
 Hex: 10mm
 GM
UNIT PACKAGE: 50



16826
 (Chry: 34201287;
 AMC: 8934201287)
 Zinc
 M6-1.0 x 20mm
Slotted Hex Washer Head License Plate Screw
 Washer Head O.D.: 13mm (1/2")
 Hex: 10mm
 Chrysler, Honda & AMC
UNIT PACKAGE: 50



24489
 Black Steel
 M6-1.0 x 20
Torx Washer Head CA Point
 T-30 Drive
 Washer Diameter: 16mm
UNIT PACKAGE: 25



12322
 (11503815, 11508023)
 Phosphate
 M6-1.0 x 20mm
Hex Head Sems* with Grounding Teeth
 Class 9.8
 Washer Outer Diameter: 17mm (21/32")
 Hex: 10mm
 GM
UNIT PACKAGE: 25



12693
 (11502941, 11506174)
 Phosphate
 M6-1.0 x 20mm
Hex Head Sems*
 Class 9.8
 Washer Outer Diameter: 17mm (21/32")
 Hex: 10mm
 GM
UNIT PACKAGE: 25



12067
 (11504570, 11509816, 11514623)
 Phosphate
 M6-1.0 x 20mm
Hex Head Sems*
 Class 9.8
 Washer Outer Diameter: 17mm (21/32")
 Hex: 10mm
 GM
UNIT PACKAGE: 50



23855

M6-1.0 x 20mm
Torx Drive Bolt with Dog Point
 Nylon Washer: 18mm
 Shoulder: 9.5mm x 5mm
 T-30 Torx Drive
 GM Saturn 1991 - On

UNIT PACKAGE: 15



24515

Zinc Steel
 M6 x 20
Torx Washer Head CA Point
 Thread Pitch: 1.0
 Washer Diameter: 18mm

UNIT PACKAGE: 25



23789

(14039261)
 Zinc
 M6-1.0 x 20mm
Torx Washer Head CA Point
 Drive Size: T30
 Washer Head Diameter: 18mm

UNIT PACKAGE: 50



24504

Silver Dacromet Steel
 M6 x 20
Indented Hex Head Dog Point
 Thread Pitch: 1.0
 Washer Diameter: 24mm
 Across Flats: 8mm

UNIT PACKAGE: 25



13617

(11503941)
 Phosphate
 M6-1.0 x 20mm
Hex Head Sems®
 Class 9.8
 Washer Outer Diameter: 24mm (15/16")
 Hex: 10mm
 GM

UNIT PACKAGE: 50



23811

(N800394-S2)
 Black
 M6-1.0 x 20mm
Hex Head Sems® with Dog Point
 Class 9.8
 Washer Outer Diameter: 24mm (15/16")
 Hex: 8mm

UNIT PACKAGE: 50



22536

(GM: 11589031)
 Black Zinc
Hex Head Sems® Body Bolt
 M6-1.0 x 20mm
 Washer Diameter: 24mm
 Hex: 10mm
 Class 9.8
 Front Bumper Support, Fender Liner,
 Grille & Headlamp Adjusting
 Cadillac Escalade, Chevrolet
 Camaro, Silverado, GMC Sierra and
 Pontiac Solstice 2006 - On

UNIT PACKAGE: 15



15778

(N606676-S36)
 Zinc
 M6-1.0 x 22.5mm
Hex Head Sems® with Dog Point
 Class 9.8
 Washer Outer Diameter: 19mm (3/4")
 Hex: 8mm
 Ford

UNIT PACKAGE: 50



12160

(N606676-S2, S100)
 Phosphate
 M6-1.0 x 22mm
High Hex Head Sems® with Dog Point
 Class 9.8
 Washer Outer Diameter: 19mm (3/4")
 Hex: 8mm
 Ford

UNIT PACKAGE: 25



22428

(Ford: W708464-S450B)
 Black Zinc
 M6-1.0 x 22mm (Includes Dog Point)
Torx® Pan Head Body Bolt with Dog Point
 Type "F" Thread Cutting Feature
 T30 Torx® Drive
 Head Diameter: 17.5mm
 Class 8.8
 Ford F-150 &
 Super Duty Trucks 2015 - On

UNIT PACKAGE: 15



24505

(Ford W503925-S36)
 Zinc Yellow Steel
 M6 x 25
Hex Head Sems Dog Point
 Thread Pitch: 1.0
 Washer Diameter: 19mm
 Across Flats: 8mm

UNIT PACKAGE: 50



23689
(11504303)
Black

M6-1.0 x 25mm
Hex Head Sems®
Class 9.8
Washer Outer Diameter: 17mm (21/32")
Across Flats: 10mm
UNIT PACKAGE: 50



12065
(11503834, 20351035)
Phosphate

M6-1.0 x 25mm
Hex Head Sems®
Class 9.8
Washer Outer Diameter: 17mm (21/32")
Hex: 10mm
GM
UNIT PACKAGE: 50



15788
(11503833)
Zinc

M6-1.0 x 25mm
Hex Head Sems®
Washer Outer Diameter: 17mm (21/32")
Hex: 10mm
GM
UNIT PACKAGE: 50



19455
(6100567)
Phosphate

M6-1.0 x 25mm
Hex Head Sems® with Dog Point
Class 9.8
Washer Outer Diameter: 19mm (3/4")
Hex: 10mm
Grille, Fender, Hood Prop & Latch
Chrysler
UNIT PACKAGE: 25



12066
(11503982)
Phosphate

M6-1.0 x 25mm
Hex Head Sems®
Class 9.8
Washer Outer Diameter: 24mm (15/16")
Hex: 10mm
GM
UNIT PACKAGE: 50



12323
(11504493)
Black Polyseal

M6-1.0 x 25mm
Hex Head Sems®
Class 9.8
Washer Outer Diameter: 24mm (15/16")
Hex: 10mm
GM
UNIT PACKAGE: 25



14947
(N801851-S45)
Stainless Steel

M6-1.0 x 26mm
Pan Head Internal Torx® Drive Sems®
T-30 Drive
Head Diameter: 14mm
Washer Outer Diameter: 16mm (5/8")
Truck Mirror Mounting Bracket Bolt
Ford Trucks
UNIT PACKAGE: 25



23808
Phosphate

M6-1.0 x 28mm
Hex Head Sems® with Dog Point
Washer Diameter: 19mm (3/4")
Across Flats: 8mm
UNIT PACKAGE: 50



15779

(N606677-S53B)
Black Zinc Phosphate
M6-1.0 x 28mm
Hex Head Sems® with Dog Point
Washer Outer Diameter: 19mm (3/4")
Hex: 8mm
Ford
UNIT PACKAGE: 50



12335

(N606677-S36)
Yellow Zinc
M6-1.0 x 28mm
Hex Head Sems® with Dog Point
Class 9.8
Washer Outer Diameter: 19mm (3/4")
Hex: 8mm
Ford
UNIT PACKAGE: 25



16893

(N800947-S, AB-181-GG)
Phosphate
M6-1.0 x 28mm
Hex Head Sems® with Dog Point
Class 9.8
Washer Outer Diameter: 25mm (1")
Hex: 8mm
Ford
UNIT PACKAGE: 25



22757

(Hyundai: 12291-06303)
Black Zinc
M6-1.0 x 29mm
Phillips Round Head License Plate Screw with Sems® Flat & Lock Washer
Sems® Flat Washer Diameter: 13mm
Sems® Lock Washer Diameter: 11mm
Hyundai Equus 2015 - 2010
Genesis 2014 - 2008
UNIT PACKAGE: 25



22232
(Ford: W711390-S900)
Black Zinc

M6-1.0 x 30mm
Hex Head Sems
with Dog Point & Thread Locking Patch
Washer Outer Diameter: 18mm (23/32")
Hex: 10mm
Ford F-150 Trucks with Aluminum Body 2015 - On
UNIT PACKAGE: 25



11633
(11501105)
Phosphate

M6.3-1.0 x 20mm
Hex Head Sems*
Class 9.8
Washer Outer Diameter: 17mm (21/32")
Hex: 10mm
GM
UNIT PACKAGE: 25



15818
(6100568)
Phosphate

M6-1.0 x 30mm
Hex Head Sems* with Dog Point
Class 9.8
Washer Outer Diameter: 19mm (3/4")
Hex: 10mm
Chrysler
UNIT PACKAGE: 50



23654
Black

M6.3-1.0 x 20mm
Hex Head Sems*
Class 9.8
Washer Head Diameter: 13mm
Across Flats: 10mm
Point Type: CA
UNIT PACKAGE: 50



20261
(10287379)
Phosphate

M6-1.0 x 30mm
Hex Head Sems*
Class 9.8
Washer Outer Diameter: 20mm (13/16")
Hex: 10mm
GM
UNIT PACKAGE: 25



11935
(11502790)
Zinc

M6.3-1.0 x 25mm
Hex Head Sems*
Class 9.8
Washer Outer Diameter: 17mm (21/32")
Hex: 10mm
GM
UNIT PACKAGE: 25



13618
(11503825)
Phosphate

M6-1.0 x 30mm
Hex Head Sems*
Class 9.8
Washer Outer Diameter: 24mm (15/16")
Hex: 10mm
GM
UNIT PACKAGE: 50



23661
(11500754)
Phosphate

M6.3-1.0 x 25mm
Hex Head Sems*
Class 9.8
Washer Diameter: 18mm
Hex: 10mm
Point Type : CA
UNIT PACKAGE: 100



18416
(11505044)
Black Phosphate

M6-1.0 x 35mm
Hex Head Sems*
Class 9.8
Washer Outer Diameter: 17mm (21/32")
Hex: 10mm
GM
UNIT PACKAGE: 50



11638
(362029m 11509589)
Phosphate

M8-1.25 x 22mm
Hex Washer Head with Serrations under the Head & Dog Point
Washer Head Outer Diameter: 18mm (23/32")
Hex: 13mm
GM
UNIT PACKAGE: 25



22906
(Chrysler: 6104374AA)
Zinc Finish

M6-1.0 x 40mm
Hex Head Sems*
Body Bolt with Dog Point
Washer Outer Diameter: 20mm
Hex: 10mm
Headlamp Bracket
Chrysler, Dodge & Jeep 2008 - On
UNIT PACKAGE: 10



23653
(11500969)
Phosphate

M8-1.25 x 30mm
Hex Washer Head
Washer Head Diameter: 13mm
Hex: 13mm
GM
UNIT PACKAGE: 25

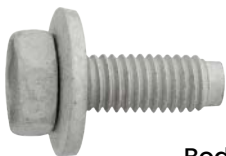

24500
(6505145AA)
Zinc Steel

M8-1.25 x 23
Body Bolt Dog Point w/Loose Washer
Across Flats: 13mm
Washer Diameter: 20mm
Chrysler & Dodge 2005 - On

UNIT PACKAGE: 25



11639
(11502605,
11502624, 11509511)
Phosphate

M8-1.25 x 25mm
Hex Washer Head
Class 9.8
Washer Head O.D.: 17mm (21/32")
Hex: 13mm
GM

UNIT PACKAGE: 25



12336
(11503632)
Phosphate

M8-1.25 x 25mm
Hex Washer Head
Class 9.8
Washer Head Outer Diameter: 17mm (21/32")
Hex: 13mm
GM

UNIT PACKAGE: 25



15790
(11505326)
Phosphate

M8-1.25 x 25mm
Hex Head Sems®
Class 9.8
Washer Outer Diameter: 17mm (21/32")
Hex: 13mm
GM

UNIT PACKAGE: 50



13613
(11503619)
Phosphate

M8-1.25 x 25mm
Hex Head Sems®
Class 9.8
Washer Outer Diameter: 24mm (15/16")
Hex: 13mm
GM

UNIT PACKAGE: 25



23817
(N606689S2)
Phosphate

M8-1.25 x 25mm
Hex Head Sems® with Dog Point
Class 9.8
Washer Outer Diameter: 22mm (7/8")
Hex: 10mm
Across Flats: 10mm
UNIT PACKAGE: 50



12348
(11500971)
Phosphate

M8-1.25 x 30mm
Hex Washer Head
Class 9.8
Washer Head Outer Diameter: 17mm (21/32")
Hex: 13mm
GM

UNIT PACKAGE: 25



11640
(549790, 11500971)
Zinc Organic

M8-1.25 x 30mm
Hex Washer Head
Class 9.8
Washer Head Outer Diameter: 17mm (21/32")
Hex: 13mm
GM

UNIT PACKAGE: 25



13614
(11501188)
Phosphate

M8-1.25 x 30mm
Hex Head Sems®
Class 9.8
Washer Outer Diameter: 24mm (15/16")
Hex: 13mm
GM

UNIT PACKAGE: 25



22908
(Chrysler: 6105103AA)
Zinc Finish

M8-1.25 x 30mm
Hex Head Sems®
Body Bolt with Dog Point
Washer Outer Diameter: 24mm
Hex: 13mm
Chrysler, Dodge & Jeep 2007 - On

UNIT PACKAGE: 5



22915
(Ford: W717793-S439)
Zinc Finish

M8-1.25 x 31mm
Hex Washer Head Sems®
Body Bolt with Dog Point
Class 10.9
Washer Outer Diameter: 24mm
Hex: 13mm
Fender & Hood Hinge
Ford Expedition & Lincoln Navigator 2018 - On
Ford F-150 2015 - On

UNIT PACKAGE: 10



15780
(N606690-S2)
Phosphate

M8-1.25 x 33mm
Hex Head Sems® with Dog Point
Class 9.8
Washer Outer Diameter: 22mm (7/8")
Hex: 10mm
Ford

UNIT PACKAGE: 50



12343
(11504982)
Phosphate

M8-1.25 x 35mm
Hex Washer Head
Class 9.8
Washer Head Outer Diameter: 17mm (21/32")
Hex: 13mm
GM

UNIT PACKAGE: 25



23711
(11502607)
Black

M10-1.50 x 30mm
Hex Flange Head
Class 9.8
Flange Diameter: 25mm
Hex: 15mm

UNIT PACKAGE: 25

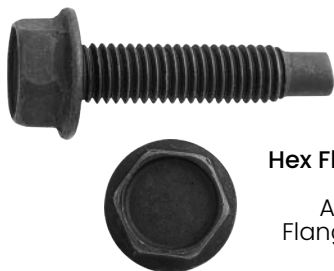

24502
(11515791)
Steel
M8 x 35
Hex Flange Head Dog Point
M8-1.25
Across Flats: 13mm
Flange Diameter: 17.5mm
Size: 10.9

UNIT PACKAGE: 15



13619
Phosphate

M10-1.50 x 30mm
Hex Head Sems*
Class 9.8
Washer Outer Diameter: 29mm (1-1/8")
Hex: 15mm

UNIT PACKAGE: 10



13705
(11503668)
Phosphate

M8-1.25 x 35mm
Hex Head Sems*
Class 9.8
Washer Outer Diameter: 24mm (15/16")
Hex: 13mm
GM

UNIT PACKAGE: 25



12327
(N605920-S2)
Phosphate

M10-1.50 x 33mm
Hex Washer Head with Dog Point
Class 9.8
Washer Head O.D.: 20mm (13/16")
Hex: 13mm
Ford

UNIT PACKAGE: 25



23796
(10037786)
Black

M8-1.25 x 40mm
Hex Flange Head
Class 10.9
Washer Head Diameter: 17mm
Across Flats: 13mm
Point Type: CA
Includes Lock Patch

UNIT PACKAGE: 50

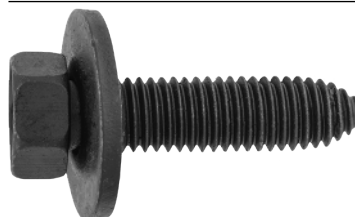

11641
(11501193)
Phosphate

M10-1.50 x 40mm
Hex Head Sems*
Class 9.8
Washer Outer Diameter: 29mm (1-5/32")
Hex: 15mm
GM

UNIT PACKAGE: 25



16931
(N606692-S2, AB-187EH)
Phosphate

M8-1.25 x 42mm
Hex Head Sems* with Dog Point
Class 9.8
Washer Outer Diameter: 22mm (7/8")
Hex: 10mm
Ford

UNIT PACKAGE: 25



13620
Phosphate

M10-1.50 x 45mm
Hex Head Sems*
Class 9.8
Washer Outer Diameter: 30mm (1-3/16")
Hex: 15mm

UNIT PACKAGE: 10

Metric Special Tapping Screw Specification Chart

Auveco Part No.	Size	Length	Hex Size	Washer/ Head O.D.	Type	Point Type	Finish	Unit Pkg	Page No.
12062	M4.2-1.41 (#8)	10mm (13/32")		11mm (7/16")	Phillips Washer Head Pozi-Drive	AB	Black Oxide	100	93
15941	M4.2-1.41 (#8)	12mm (15/32")		9.5mm (3/8")	Phillips Truss Head	AB	Black Oxide	10	93
12739	M4.2-1.41 (#8)	12mm (15/32")		10mm (25/64")	Phillips Washer Head Pozi-Drive	AB	Chrome	100	93
23909	M4.2-1.41	12mm		11mm	Phillips	Teks	Black	100	93
23834	#8	1/2"			Phillips Oval Head Sems	A/AB	Chrome	100	93
12059	M4.2-1.41 (#8)	13mm (33/64")		11mm (7/16")	Phillips Washer Head	AB	Zinc	100	93
12061	M4.2-1.41 (#8)	13mm (33/64")		8.5mm (11/32")	Phillips Round Washer Head, Pozi-Drive	AB	Black Oxide	100	93
23876	M4.2-1.41	13mm		11mm	Torx	Teks	Black	50	93
23814	M4.2-1.41	13mm		11mm	Phillips Pozi	AB	Black	50	93
23794	M4.2-1.41	13mm		8mm	Phillips Pozi	Teks	Chrome	100	94
13712	M4.2-1.41 (#8)	13mm (33/64")		11mm (7/16")	Phillips Washer Head	AB	Black Zinc	50	94
12740	M4.2-1.41 (#8)	13mm (33/64")	7mm	12mm (15/32")	Hex Head Sems	AB	Phosphate	100	94
21122	M4.2-1.41 (#8)	14mm (9/16")		11mm (7/16")	Phillips Washer Head Pozi-Drive	Teks*	Chrome	50	94
23833	M4.2-.79	15mm		11mm	Phillips	Teks	Black	100	94
23841	M4.2-1.41	15mm		12mm	Phillips Pan Head Sems	A/AB	Black	100	94
18817	M4.2-1.41 (#8)	16mm (5/8")		11mm (7/16")	Phillips Round Washer Head, Pozi-Drive	Teks	Black Zinc	100	94
16720	M4.2-1.41 (#8)	16mm (5/8")		9.5mm (3/8")	Phillips Truss Head	AB	Black Oxide	100	94
12741	M4.2-1.41 (#8)	16mm (5/8")	7mm	12mm (15/32")	Hex Head Sems	AB	Phosphate	100	94
23792	M4.2-1.41	16mm			Phillips Pan	Teks	Black	100	94
18261	M4.2-1.41 (#8)	16mm (5/8")	7mm	12mm (15/32")	Hex Washer Head Sems	Teks	Phosphate	50	94
23869	M4.2-1.41	18mm	7mm	12mm	Hex Head Sems	B	Black	50	95
23809	M4.2-1.41	17mm		9mm	Hex Washer Head	A/AB	Black	100	95
24465	M4.2	19mm		11mm	Phillips Flat Washer Head	AB	Black Steel	100	95
23837	#8	3/4"		#6 Hd	Phillips Oval Head Sems	A/AB	Black	100	95
24589	M4.2	20mm			Metric Torx Head	AB	Chrome	50	95
24458	M4.2	20mm			Phillips Oval Head	Self Drilling	Black Steel	50	95
22549	M4.2-1.41	19mm	7mm	12.5mm	Hex Washer Head		Zinc	25	95
12060	M4.2-1.41 (#8)	20mm (25/32")		11mm (7/16")	Phillips Washer Head	AB	Black Oxide	100	95
22550	M4.2-1.41	20mm		11mm	Round Washer Head Pozi-Drive	BR	Black Zinc	25	93
24450	M4.2-1.41 (#8)	20mm (25/32")		7/16"	Phillips Flat Washer Head	AB	Zinc	100	95
12097	M4.2-1.41 (#8)	20mm (25/32")		12mm (15/32")	Phillips Pan Head Sems*	AB	Chrome	50	95
12738	M4.2-1.41 (#8)	20mm (25/32")	7mm	12mm (15/32")	Hex Washer Head Sems	AB	Phosphate	50	95
12742	M4.2-1.41 (#8)	20mm (25/32")	7mm	12mm (15/32")	Hex Head Sems	AB	Phosphate	100	95
24428	M4.2-1.41	20mm		12mm	Indented Hex Washer Head	Teks	Black Steel	50	96

(Continued on next page)

Metric Special Tapping Screw Specification Chart

Auveco Part No.	Size	Length	Hex Size	Washer/ Head O.D.	Type	Point Type	Finish	Unit Pkg	Page No.
15373	M4.2-1.41 (#8)	20mm (25/32")	7mm	16mm (5/8")	Hex Head Sems	AB	Phosphate	50	96
20271	M4.2-1.41 (#8)	20mm (25/32")		16mm (5/8")	Phillips Pan Head Sems	AB	Phosphate	50	96
24183	M4.2-1.41	20mm		17mm	Hex Head Sems	A/AB	Black	50	96
20476	M4.2-1.41 (#8)	20mm (25/32")	7mm	17mm (11/16")	Hex Washer Head Sems	Teks	Phosphate	50	96
24475	M4.2-1.41	20mm		17mm	Phillips Indented Hex Head	AB	Black Steel	50	96
19278	M4.2-1.41 (#8)	20mm (25/32")	7mm	20mm (25/32")	Hex Head Sems	AB	Black Phos.	50	96
15775	M4.2-1.41 (#8)	20mm (25/32")	7mm	12mm (15/32")	Hex Head Sems	Teks®	Phosphate	50	96
22070	M4.2-1.41 (#8)	20mm (25/32")		17mm (11/16")	Torx® Pan Head Sems*	Dog Pt	Black Zinc	50	96
22104	M4.2-1.41	22mm	5.5mm	16mm	Hex Head Sems	AB	Black Zinc	50	96
19006	M4.2-1.41 (#8)	25mm (1")		11mm (7/16")	Round Washer Head, Pozi-Drive	Teks	Phosphate	100	96
23793	M4.2-1.41	25mm			Phillips Pozi	AB	Zinc	100	96
20382	M4.2-1.41 (#8)	25mm (1")	T-15 Drive	12mm (15/32")	Torx Pan Head Sems	AB	Black Zinc	50	96
22081	M4.2-1.41	25mm		17mm	Pozi-Drive Round Washer Head Sems	AB	Black Zinc	50	96
18336	M4.2-1.41 (#8)	25mm (1")	7mm	12mm (15/32")	Hex Head Sems	AB	Black Phos	100	97
22724	M4.2-1.41	25mm	7mm	12.5mm	Indednted Hex Flange Head Sems	BR	Black Zinc	50	97
25101	M4.2-1.41	25mm	7mm	17mm	Bumper, Fender Apron Moulding Hex Head Sems	BR	Zinc	50	97
24467	M4.2-1.41	25mm		17mm	Hex Head	AB	Black Steel	50	97
24529	M4.2-1.41	25mm		22mm	Unslotted Indented Hex Head	AB	Black Steel	50	97
19653	M4.2-1.41 (#8)	30mm (1-3/16")	7mm	17mm (11/16")	Hex Head Sems	AB	Black Phos	15	97
25150	M4.2-1.41	34mm	7mm	14.5mm	Hex Washer Head Sems with Lock Patch	Hex	Black Zinc & Nickel	25	97
24495	M4.2-1.41	35mm		17mm	Indented Hex Head	AB	Black	50	97
24517	M4.2	35mm		12mm	Unslotted Indented Hex Head	AB	Black	50	97
24538	M4.2-1.41	35mm		8mm	Phillips Pozidrive	AB	Black Steel	50	97
23698	M4.2-1.41	40mm (1-1/2")			T-15 Torx Oval Head	A/AB	Chrome	25	97
24132	M4.2-1.41				Phillips Pan	#2	Black	100	97
18340	M4.8-1.61 (#10)	15mm (19/32")		14mm (9/16")	Phillips Truss Head	AB	Black Phos	50	98
23838	(#10)	(5/8")			Phillips Oval Head Sems	A/AB	Black	100	98
23835	(#10)	(5/8")			Phillips Oval Head Sems	A/AB	Chrome	100	98
17459	M4.8-1.61 (#10)	16mm (5/8")		11mm (7/16")	Phillips Truss Head	AB	Black Oxide	100	98
22537	M4.8-1.59	16mm	7mm	12.5mm	Hex Head	B	Zinc	25	98
24176	M4.8-1.61	16mm	8mm	15mm	Hex Head Sems	A/AB	Black	100	89
23847	M4.8-1.61	16mm	8mm	16mm	Hex Head Sems	A/AB	Zinc	50	98
22030	M4.8-1.61 (#10)	16mm (5/8")	8mm	18mm	Hex Head Sems	AB	Black Zinc	50	98
24427	M4.8-1.59	16mm	8mm	19mm	Hex Head	AB	Black Zinc	50	98

(Continued on next page)

Metric Special Tapping Screw Specification Chart

Auveco Part No.	Size	Length	Hex Size	Washer/ Head O.D.	Type	Point Type	Finish	Unit Pkg	Page No.
22110	M4.8-1.61	18mm	T-25 Drive	15mm	Torx Truss Head	AB	Black Zinc	25	98
21774	M4.8-1.61 (#10)	20mm (25/32")	8mm	26mm	Hex Head Sems	AB	Black E-Coat	25	98
23836	(#10)	1"			Phillips Oval Head Sems	A/AB	Chrome	100	98
20259	M4.8-1.61 (#10)	19mm (3/4")		16mm (5/8")	Phillips Truss Head Sems	AB	Black E Coat	25	98
24172	M4.8-1.61	19mm	8mm	15mm	Hex Head Sems	A/AB	Black	100	98
16589	M4.8-1.61 (#10)	19mm (3/4")	8mm	15mm (19/32")	Hex Head Sems	AB	Yellow Zinc Dichromate	50	99
25409	M6-1.81	25mm		16mm	Phillips Truss Head	AB	Black Zinc	25	100
21865	M4.8-1.61 (#10)	32mm (1-1/4")	8mm	19mm (3/4")	Hex Head Sems	AB	Phosphate	50	100
21746	M5-1.59	11mm		11mm	Phillips Truss Head	AB	Black Oxide	50	99
21747	M5-1.59	11mm		12mm	Phillips Round Washer Head	AB	Black Oxide	50	99
19251	M5-1.59	16mm	8mm	16mm	Phillips Hex Head Sems	A	Black Zinc	50	99
24480	M5	20mm		16mm	Phillips Truss Head	AB	Black Zinc	25	99
22294	M5-1.81	16mm	8mm	16mm	Phillips Hex Head Sems	B	Black Phos.	25	99
22203	M5-1.81	20mm		13mm	Phillips Flat Head	AB	Black Phos.	100	99
25395	M5-2.12	15mm	8mm	18mm	Hex Head Sems	B	Zinc	25	100
25203	M5-2.12	16mm		11mm	Round Washer Head	T20	Zinc	50	101
25394	M5-2.12mm	18mm		16mm	Phillips Truss Washer Head	AB	Black Zinc	25	101
25397	M5-2.12	18mm	8mm	22mm	Hex Head Sems	AB	Black Zinc	25	101
22111	M5-2.12 (#12)	19mm (3/4")	T-25 Drive	14mm	Torx Truss Head	AB	Black Zinc	25	101
20455	M5 (#12)	20mm (25/32")		14mm (9/16")	Phillips Truss Head	AB	Black Phos	50	101
22348	M5-2.2	20mm		20mm	Torx Pan Head Sems	B	Black	15	101
21841	M5.2-2.0 (#12)	20mm (25/32")	8mm	12mm (1/2")	Phillips Hex Head Sems*	AB	Black E-Coat	25	100
21839	M5.2-2.0 (#12)	21mm (13/16")	10mm	14mm (9/16")	Phillips Hex Head Sems	AB	Zinc	25	100
25317	M5.2-2.12	18mm	8mm	16mm	Hex Head Sems	BR	Black	25	100
25225	M5.48-1.81	18mm	8mm	15mm	Hex Head Sems	AB	Black E-Coat	50	102
21541	M5.5 (#12)	20mm (25/32")	T-20 Drive	15mm (19/32")	Torx® Truss Head	AB	Black Zinc	25	102
22292	M5.5-1.81 (#12)	16mm (5/8")		13mm (33/64")	Phillips Truss Head	AB	Black Phos.	25	101
17461	M5.5-1.81 (#12)	18mm (45/64")	8mm	15mm (19/32")	Hex Head Sems	AB	Yellow Zinc Dichromate	50	101
25258	M6-1.81	15mm	10mm	18mm	Hex Head Sems	B	Zinc	25	102
21744	M6-1.81	20mm	10mm	13mm	Phillips Hex Head Sems	AB	Black E-Coat	25	102
19170	M6.3-1.81 (#14)	16mm (5/8")		15mm (19/32")	Phillips Truss Head	AB	Black Phos.	50	102
15776	M6.3-1.81 (#14)	16mm (5/8")	8mm	16mm (5/8")	Hex Head Sems	AB	Phosphate	50	102
12057	M6.3-1.81 (#14)	16mm (5/8")	10mm	17mm (11/16")	Hex Head Sems	AB	Phosphate	50	102
22106	M6.3-2.5	18mm	10mm	14mm	Phillips Hex Head Sems	AB	Zinc	25	102
13019	M6.3-1.81 (#14)	19mm (3/4")	8mm	11.5mm (29/64")	Hex Washer Head	AB	Phosphate	50	102
24441	M6.3-1.81	20mm		13mm	Phillips Hex	AB	Black Zinc	50	102

(Continued on next page)

Metric Special Tapping Screw Specification Chart

Auveco Part No.	Size	Length	Hex Size	Washer/ Head O.D.	Type	Point Type	Finish	Unit Pkg	Page No.
20556	M6.3-1.81	20mm (#14)	10mm (25/32")	16mm	Phillips Hex Head Sems (5/8")	AB	Black Zinc	50	102
12351	M6.3-1.81	20mm (#14)	10mm (25/32")	17mm (11/16")	Hex Washer Head Sems	AB	Black Phos.	50	103
16828	M6.3-1.81	20mm (#14)	10mm (25/32")	18mm (45/64")	Hex Head Sems	AB	Yellow Zinc Dichromate	25	103
25226	M6.3-1.81	20mm	10mm	18mm	Hex Head Sems		Black E-Coat	25	103
20557	M6.3-1.81	20mm (#14)	10mm (25/32")	20mm (25/32")	Phillips Hex Head Sems	AB	Black Zinc	50	103
24173	M6.3-1.81	20mm	10mm	23.5mm	Hex Head Sems	A/AB	Black	50	103
23695	M6.3-1.81	22mm	10mm	24mm	Hex Head Sems	A/AB	Black	50	103
21838	M6.3-2.5	24mm (#14)	10mm (15/16")	16mm (5/8")	Phillips Hex Head Sems	AB	Zinc	25	103
12339	M6.3-1.81	25mm (#14)	10mm (1")	17mm (11/16")	Hex Head Sems	AB	Phosphate	50	103
24466	M6.3	25mm	10mm	24mm	Hex Head	AB	Black Steel	25	103
12354	M6.3-1.81	30mm (#14)	10mm (1-3/16")	17mm (11/16")	Hex Head Sems	AB	Phosphate	50	103
12068	M6.3-1.81	30mm (#14)	10mm (1-3/16")	24mm (15/16")	Hex Head Sems	AB	Phosphate	50	103
25237	M6.3-2.5	16mm	10mm	18mm	Phillips Hex Head Sems	AB	Black E-Coat	50	103
25078	M6.3-2.5	18mm	10mm	16mm	Phillips Hex Head Sems	AB	Black Dacr.	50	103
24442	M6.3	35mm		24mm	Hex Head	AB	Black Steel	25	103
22295	M6.5-1.81	18mm		16mm	Phillips Truss Head	AB	Black Phos.	25	104
22296	M6.5-1.81	25mm		16mm	Phillips Truss Head	AB	Black Phos.	25	104
21837	M6.5-2.5	19mm	10mm	20mm	Phillips Hex Head Sems	AB	Black E-Coat	25	104
19417	M7.5	35mm (1-3/8")	#3 Sq. Drive	22mm (7/8")	Nylon Square Drive Truss Head	AB	Black Nylon	15	104
12350	M8-2.12	20mm (5/16"-12)	13mm (25/32")	16mm (5/8")	Hex Washer Head	AB	Phosphate	25	104
21517	M9.5	46mm (1-13/16")	#3 Sq. Drive	22mm (7/8")	Nylon Square Drive Truss Head	AB	Black Nylon	25	105
20970	M14	34mm (1-11/32")	#3 Sq. Drive	22mm (7/8")	Nylon Square Drive Truss Head	AB	Black Nylon	25	105

Specialty Thread Forming Screws

Auveco Part No.	Size	Length	Hex Size	Washer/ Head O.D.	Type	Point Type	Finish	Unit Pkg	Page No.
25204	M4-1.75	14mm	T-20	8.9mm	46637659479	B	Phosp.	50	
25007	M3-1.12	6mm	T-10	6.3mm	11570768	B	Zinc	15	
25008	M3-1.12	10mm	TS-20	8.7mm	11547683	B	Black	25	
25009	M3-1.12	12mm	T-10	6mm	11561265, W506923S450B	B	Black	25	
25010	M4-1.46	8mm	T-10	8.7mm	W506941-S450B 11546966	B	Black	25	
25011	M4-1.46	10mm	T-20	8.7mm	6510170AA, 11546967 W506942S450B	B	Black	50	
25012	M4-1.46	12mm	T-20	8.7mm	6510329AA, 11546968 W506943S450B	B	Black	25	
25013	M4-1.46	14mm	T-20	8.7mm	6510330AA, 11546969, W506944S450B	B	Black	50	
25014	M4-1.46	16mm	T-20	8.7mm	6510331AA, 11546970, W506945S450B	B	Black	25	
25015	M5-1.80	16mm	T-25	10.7mm	6510672AA, 11611225 W506964S450B	B	Black	25	

METRIC ITEMS



Metric Torx® Insert Bits for Torx Screws 1" Shank

Auveco Part No.	Bit Size	For Screw Size	Unit Pkg.
12472	T-10	No. 4	1
11949	T-15	No. 6, M4.2	1
11950	T-20	No. 8, M4.2	1
12103	T-25	No. 10	1
14913	T-27	No. 12, 1/4"	1
12104	T-30	1/4", M6	1
12105	T-40	5/16", M8	1

* 1/4" Shank



12062 (11501903) Black Oxide

M4.2-1.41 x 10mm (#8 x 13/32")
Phillips Washer Head
Pozi-Drive
Washer Head Outer Diameter: 11mm (7/16")
GM

UNIT PACKAGE: 100



15941 Black Oxide

M4.2-1.41 x 12mm (#8 x 15/32")
Phillips Truss Head
Head Diameter: 9.5mm (3/8")
Japanese Imports

UNIT PACKAGE: 10

16596

Same as 15941 except for unit package quantity

UNIT PACKAGE: 100



12059 (11501883) Zinc

M4.2-1.41 x 13mm (#8 x 33/64")
Phillips Washer Head
Pozi-Drive
Washer Head Outer Diameter: 11mm (7/16")
GM

UNIT PACKAGE: 100



12061 (11501896) Black Oxide

M4.2-1.41 x 13mm (#8 x 33/64")
Phillips Round Washer Head
Pozi-Drive
Washer Head Outer Diameter: 8.5mm (11/32")
GM

UNIT PACKAGE: 100



23876 Black Oxide

M4.2-1.41 x 13mm (#8 x 33/64")
Torx Washer Head
Pont Type: A/AB
Washer Head Diameter: 11mm

UNIT PACKAGE: 50



23814 (20725768 ; 11509153) Black

M4.2-1.41 x 13mm (#8 x 33/64")
Phillips Pozi Washer Head
Pont Type: A/AB
Washer Head Diameter: 11mm
Includes Bi-Wax

UNIT PACKAGE: 50

(Continued on next page)



23794
(11502630)
Chrome

M4.2-1.41 x 13mm (#8 x 33/64")
Phillips Pozi Washer Head
Point Type: A/AB
Washer Head Diameter: 8mm

UNIT PACKAGE: 100

WARNING: Reproductive Harm & Cancer
www.P65Warnings.ca.gov



12739
(11501794)
Chrome

M4.2-1.41 x 12mm (#8 x 15/32")
Phillips Washer Head
Pozi-Drive
Washer Head Diameter: 10mm (25/64")
GM

UNIT PACKAGE: 100

WARNING: Reproductive Harm & Cancer
www.P65Warnings.ca.gov



23909
Black

M4.2-1.41 x 12mm (#8 x 15/32")
Phillips Washer Head
Pozi-Drive
Washer Head Diameter: 11mm
Point Type: A/AB

UNIT PACKAGE: 100



13712
(11505104)
Black Zinc

M4.2-1.41 x 13mm (#8 x 33/64")
Phillips Washer Head
Washer Head Outer Diameter: 11mm (7/16")
GM

UNIT PACKAGE: 50



12740
(11503394)
Phosphate

M4.2-1.41 x 13mm (#8 x 33/64")
Hex Head Sems*
Washer Outer Diameter: 12mm (15/32")
Hex: 7mm
GM

UNIT PACKAGE: 100



21122
Chrome

M4.2-1.41 x 14mm (#8 x 9/16")
Phillips Pozi Drive Washer Head Teks*
Washer Head Outer Diameter: 11mm (7/16")

UNIT PACKAGE: 50

WARNING: Reproductive Harm & Cancer
www.P65Warnings.ca.gov



23833
(10169998; 10155743; 10120517)
Black

M4.2-.79 x 15mm
Phillips Serrated Washer Head
Washer Head Diameter: 11mm (7/16")
Point Type: A/AB

UNIT PACKAGE: 100



23841
(11503499)
Black Finish

M4.2-1.41 x 15mm
Phillips Pan Head Sems*
Washer Outer Diameter: 12mm
Point Type : A/AB

UNIT PACKAGE: 50



18817
(1746408)
Black Zinc

M4.2-1.41 x 16mm (#8 x 41/64")
Phillips Round Washer Head with Serrations under the Head
Pozi-Drive with Teks* Point
Washer Head Outer Diameter: 11mm (7/16")
Moulding, Trim & General Purpose
GM

UNIT PACKAGE: 100



16720
Black Oxide

M4.2-1.41 x 16mm (#8 x 5/8")
Phillips Truss Head
Head Diameter: 9.5mm (3/8")
Honda

UNIT PACKAGE: 100



23792
Black

M4.2-1.41 x 16mm (#8 x 5/8")
Phillips Pan Head
Point Type: #2 Drill
UNIT PACKAGE: 100



12741
(11503395)
Phosphate

M4.2-1.41 x 16mm (#8 x 5/8")
Hex Head Sems*
Washer Outer Diameter: 12mm (15/32")
Hex: 7mm
GM

UNIT PACKAGE: 100



18261
(11503578, 11503785)
Phosphate

M4.2-1.41 x 16mm (#8 x 5/8")
Hex Washer Head Sems* with Teks* Point
Washer Outer Diameter: 12mm (1/2")
Hex: 7mm
GM

UNIT PACKAGE: 50



23869

Black Finish

M4.2-1.41 x 18mm
Hex Washer Head Sems® with Teks® Point
 Washer Diameter : 12mm
 Hex: 7mm
 Point Type : B
UNIT PACKAGE: 50



24465

Black Finish Steel

M4.2 x 19
Phillips Flat Top Washer Head
 Point Type: Self Drilling
 Washer Head Diameter: 11mm

UNIT PACKAGE: 100



23837

Black Finish

#8 x 3/4"
Phillips Oval Head Sems®
 Head Size : #6
 Point Type : A/AB
UNIT PACKAGE: 100



23809

(11508827)
 Black Finish

M4.2 x 1.41
Hex Washer Head Sems® with Teks® Point
 Point Type: A/AB
 Washer Head Diameter: 9mm
 Hex: 7mm
 Length: 17mm
UNIT PACKAGE: 100



24589

(11504069)
 Chrome Finish Steel

M4.2 x 20
Metric Torx Head
 Head Style: Oval
 Point Type: AB
 Drive Type: Torx
UNIT PACKAGE: 50



24458

(11509707)
 Black Steel

M4.2 x 20
Phillips Oval Head w/Loose Flush Washer
 Point Type: Self Drilling
UNIT PACKAGE: 50



22549

(Ford: W704875-S439)
 Zinc Organic

M4.2-1.41 x 19mm
Hex Washer Head Tapping Screw
 Hex: 7mm
 Washer Diameter: 12.5mm
 Ford Escape, Explorer, Edge, Expedition,
 F-150/250/350/450/550, Flex, Taurus &
 Thunderbird and Lincoln LS, Mark LT,
 MKX & MKZ 1999 - On
UNIT PACKAGE: 25

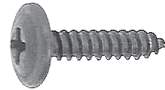

12060

(11501884)
 Black Oxide

M4.2-1.41 x 20mm (#8 x 25/32")
Phillips Washer Head
 Washer Head Outer Diameter: 11mm (7/16")
 GM

UNIT PACKAGE: 100



24450

Zinc Finish Steel

M4.2 x 20mm (#8 x 3/4")
Phillips Flat Washer Head
 Point Type: AB
 Washer Diameter: 7/16"
 Zinc Finish

UNIT PACKAGE: 100



22550

(GM: 11609457)
 Black Zinc

M4.2-1.41 x 20mm
Round Washer Head Pozi-Drive Tapping Screw
 Head Diameter: 11mm
 Tail Lamp Assembly
 Buick Cascada, Enclave, Encore, Cadillac
 CTS, Chevrolet Avalanche, Camaro,
 Caprice, Corvette, Impala, Monte Carlo
 & Trax and Pontiac G6 2000 - On

UNIT PACKAGE: 25



12097

(9420052, 11502483, 11503503)
 Chrome

M4.2-1.41 x 20mm (#8 x 25/32")
Phillips Pan Head Sems® Pozi-Drive
 Washer Outer Diameter: 12mm (1/2")
 GM

UNIT PACKAGE: 50



12738

(11504056, 11513801)
 Phosphate

M4.2-1.41 x 20mm (#8 x 25/32")
Hex Washer Head Sems®
 Washer Outer Diameter: 12mm (1/2")
 Hex: 7mm
 Radiator & Grille
 GM

UNIT PACKAGE: 50



12742

(11503396, 11503483)
 Phosphate

M4.2-1.41 x 20mm (#8 x 25/32")
Hex Head Sems®
 Washer Outer Diameter: 12mm (1/2")
 Hex: 7mm
 Front End & Air Conditioner
 GM

UNIT PACKAGE: 100



24428
Black Steel
M4.2-1.41 x 20
**Indented Hex Washer Head
w/Loose Washer**
Washer Diameter: 12mm
Across Flats: 7mm
Drive Type: Self Drilling
UNIT PACKAGE: 50



15373
(11503892, 11500434)
Phosphate
M4.2-1.41 x 20mm (#8 x 25/32")
Hex Head Sems®
Washer Outer Diameter: 16mm (5/8")
Hex: 7mm
GM
UNIT PACKAGE: 50



20271
(N801603-S2)
Phosphate
M4.2-1.41 x 20mm (#8 x 25/32")
Phillips Pan Head Sems®
Washer Outer Diameter: 16mm (5/8")
Ford
UNIT PACKAGE: 50



24183
Black Phosphate
M4.2-1.41 x 20mm (#8 x 25/32")
Hex Head Sems®
Washer Diameter: 17mm (11/16")
Across Flats: 6mm
Point Type: A/AB
UNIT PACKAGE: 50



20476
Phosphate
M4.2-1.41 x 20mm (#8 x 25/32")
Hex Washer Head Sems® Teks®
Washer Outer Diameter: 17mm (11/16")
Hex: 7mm
General Purpose
UNIT PACKAGE: 50



24475
(11588286)
Black Steel
M4.2-1.41 x 20
Phillips Indented Hex Head
Point Type: AB
Washer Diameter: 17mm
Across Flats: 7mm
GM
UNIT PACKAGE: 50



19278
(GM: 14090382; Chry: 6506161-AA)
Black Phosphate
M4.2-1.41 x 20mm (#8 x 25/32")
Hex Head Sems®
Washer Outer Diameter: 20mm
Hex: 7mm
GM
UNIT PACKAGE: 50



15775
Phosphate
M4.2-1.41 x 20mm (#8 x 25/32")
Hex Head Sems® with Teks® Point
Washer Outer Diameter: 12mm (1/2")
Hex: 7mm
UNIT PACKAGE: 50



22070
(GM: 11570637)
Black Zinc
M4.2-1.41 x 20mm (#8 x 25/32")
Torx® Pan Head Sems®
Tapping Screw with Dog Point
T15 Drive
Washer Outer Diameter: 17mm (11/16")
GM 2007 - On
UNIT PACKAGE: 50



22104
(Ford: N801169-S900)
Black Zinc
M4.2-1.41 x 22mm
Hex Head Sems® Tapping Screw
Hex Size: 5.5mm
Washer Diameter: 16mm
Front Bumper, Exterior Trim & Front Fender
Ford & Lincoln 2010 - 1997
UNIT PACKAGE: 50



23793
(N802337S9)
Zinc
M4.2-1.41 x 25mm (#8 x 1")
Phillips Pozi Oval Sems®
Point Type: A/AB
UNIT PACKAGE: 100



19006
Phosphate
M4.2-1.41 x 25mm (#8 x 1")
**Round Washer Head
Pozi-Drive with Teks® Point**
Washer Head Outer Diameter: 11mm (7/16")
General Purpose
UNIT PACKAGE: 100



20382
(Not Available from O.E.M.)
Black Zinc
M4.2-1.41 x 25mm (#8 x 1")
Torx® Pan Head Sems®
T-15 Drive
Washer Outer Diameter: 12mm (1/2")
UNIT PACKAGE: 50



22081
(GM: 11609762)
Black Zinc
M4.2-1.41 x 25mm
**Pozi-Drive Round Washer
Head Sems® Tapping Screw**
Washer Diameter: 17mm
Chevrolet Equinox, GMC Acadia & Terrain
and Saturn Outlook 2007 - On
UNIT PACKAGE: 50



18336
Black Phosphate
M4.2-1.41 x 25mm (#8 x 1")
Hex Head Sems®
Washer Outer Diameter: 12mm (1/2")
Hex: 7mm

UNIT PACKAGE: 100



22724
(GM: 11589012)
Black Zinc
M4.2-1.41 x 25mm
**Indented Hex Flange
Head Sems® Tapping Screw**
Hex: 7mm
Washer Diameter: 12.5mm
Signal Lamp Mounting, Interior Door Trim,
Instrument Panel, Radio & Speaker Mounting,
Rear Bumper & Liftgate Buick Allure, Cascada, Enclave,
Encore, Envision, LaCrosse, Lesabre, Lucerne, Park
Avenue, Rainier, Regal & Verano and Cadillac ATS, CT6,
CTS, Deville, DTS, Eldorado, ELR, Escalade, Seville, SRX,
STS, XT5 & XTS and Chevrolet Avalanche, Blazer, Bolt
EV, Camaro, Captiva Sport, Cobalt, Colorado, Corvette,
Cruze, Equinox, Express, HHR, Impala, Lumina, Malibu,
Monte Carlo, Orlando, S10, Silverado, Sonic, Spark, SS,
SSR, Suburban, Tahoe, Trailblazer, Traverse, Trax &
Volt and GMC Acadia, Canyon, Envoy, Savana, Sierra,
Sonoma, Terrain & Yukon and Hummer H2 & H3 and
Pontiac Bonneville, G5, Grand Am, Pursuit, Solstice &
Torrent and Saturn Ion, Outlook & Sky 1987-On

UNIT PACKAGE: 50



25101
(Ford: W715060-S439)
Zinc Dacromet
**Bumper, Fender Apron & Moulding Hex
Head Sems® Tapping Screw**
M4.2-1.41 x 25mm
Hex: 7mm
Washer Diameter: 17mm
Ford Explorer & Mustang 2010 - On,
Fusion 2013 - On; Lincoln MKZ 2019 - 2013

UNIT PACKAGE: 50



24467
(25655545, 11515354)
Black Steel
M4.2-1.41 x 25
**Hex Head Screw
with Loose Washer**
Washer Diameter: 17mm
Point Type: AB
Across Flats: 7mm

UNIT PACKAGE: 50



24529
(W710441-S)
Black Steel
M4.2-1.41 x 25
**Unslotted Indented Hex
Washer Head w/Loose Washer**
Across Flats: 7mm
Washer Diameter: 22mm
Point Type: AB
Ford & Universal
UNIT PACKAGE: 50



19653
(N811534-S61)
Black Phosphate
M4.2-1.41 x 30mm (#8 x 1-3/16")
Hex Head Sems®
Washer Outer Diameter: 17mm (11/16")
Hex: 7mm
Ford

UNIT PACKAGE: 15



25150
(Ford: W711401-S450B)
Black Zinc & Nickel
M4.2-1.41 x 34mm
**Hex Head Tapping Screw
with Sems® Washer & Lock Patch**
Washer Diameter: 14.5mm
Hex: 7mm
Wheel Opening Moulding & Mud Flap
Ford F250 - F550 SD 2016 - On

UNIT PACKAGE: 25



24495
(11518755)
Black Steel
M4.2-1.41 x 35
**Indented Hex Head
w/Loose Washer**
Across Flats: 7mm
Washer Diameter: 17mm
Point Type: AB

UNIT PACKAGE: 50

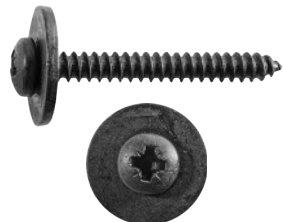

24538
(Ford W707484-S900)
Black Zinc Steel
M4.2-1.41 x 35
**Phillips Pozidrive
w/ Loose Washer**
Washer Diameter: 16mm
Point Type: AB

UNIT PACKAGE: 50



24132
Black
#8 x 1-1/2
Phillips Pan Head
Point Type: #2 Drill

UNIT PACKAGE: 100



23698
(11504654)
Chrome
M4.2-1.41 x 40mm
T-15 Torx Oval Head
Head Size: M3.5
Point Type: A/AB

UNIT PACKAGE: 50

WARNING: Reproductive Harm & Cancer
www.P65Warnings.ca.gov



18340

(Nissan; 01451-00841,
Hyundai & Kia: 12493-05167B)
Black Phosphate
M4.8-1.61 x 15mm (#10 x 19/32")
Phillips Truss Head
Head Outer Diameter: 14mm (9/16")
Nissan 1998 - On, NV200 2013 - On
Bumpers

UNIT PACKAGE: 50



23838

Black Finish
M4.8-1.61 x 16mm (#10 x 5/8")
Phillips Oval Head Sems®
Head Size: #8
Point Type: A/AB

UNIT PACKAGE: 100



23835

Chrome
M4.8-1.61 x 16mm (#10 x 5/8")
Phillips Oval Head Sems®
Head Size: #8
Point Type: A/AB

UNIT PACKAGE: 100

WARNING: Reproductive Harm & Cancer
www.P65Warnings.ca.gov



17459

Black Oxide
M4.8-1.61 x 16mm (#10 x 5/8")
Phillips Truss Head
Head Diameter: 11mm (7/16")
Imports

UNIT PACKAGE: 100



22537

(Ford: W704874-S439)
Zinc Organic
M4.8-1.59 x 16mm
(Special Hi-Lo Thread)
Hex Washer Head Screw
Washer Diameter: 12.5mm
Hex: 7mm
Ford Escape, Expedition, Explorer,
Fusion, Taurus, Thunderbird, Lincoln
Aviator, Continental, LS, MKC, MKZ,
Navigator, Town Car, Mercury Mariner,
Mountaineer & Sable 2000 - On

UNIT PACKAGE: 25



24176

Black
M4.8-1.61 x 16mm (#10 x 5/8")
Hex Head Sems®
Washer Diameter: 15mm
Across Flats: 8mm
Point Type: A/AB

UNIT PACKAGE: 50

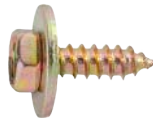

23847

(07119916946)
Zinc
M4.8-1.61 x 16mm (#10 x 5/8")
Hex Head Sems®
Washer Diameter: 16mm
Across Flats: 8mm
Point Type: A/AB

UNIT PACKAGE: 50



22030

(BMW: 07-14-7-129-160)
Black Zinc
M4.8-1.61 x 16mm (#10 x 5/8")
Hex Head Sems®
Washer Outer Diameter: 18mm
Hex: 8mm
BMW 2013 - 1999

UNIT PACKAGE: 50



24427

Black Zinc Steel
M4.8-1.59 x 16
Hex Head w/Loose Washer
Across Flats: 8mm
Washer Diameter: 19mm
Point Type: AB
Ford & Universal

UNIT PACKAGE: 50



22110

(VW: N90775801,
BMW: 07146963883)
Black Zinc
M4.8-1.61 x 18mm
Torx® Truss Head Tapping Screw
T25 Drive
Head Diameter: 15mm
Audi & VW 1998 - On
BMW 5, 6 & 7 Series 2011 - 00

UNIT PACKAGE: 25



20259

(90114-SZ3-000, 90114-SE0-000)
Black E-Coat
M4.8-1.61 x 19mm (#10 x 3/4")
Phillips Truss Head Sems®
Washer Outer Diameter: 16mm (5/8")
Splash Shield & General Purpose
Honda 1986 - On

UNIT PACKAGE: 25



24172

(07119904288)
Black Phosphate
M4.8-1.61 x 19mm
Hex Head Sems®
Washer Diameter: 15mm
Across Flats: 8mm
Point Type: A/AB

UNIT PACKAGE: 50



16589

Yellow Zinc Dichromate

#10 x 3/4 (19mm)

Indented Hex Head Sems®

Washer Outer Diameter: 19/32"

Hex: 5/16" (8mm)

Honda, Nissan, Toyota

UNIT PACKAGE: 50

⚠ WARNING: Reproductive Harm & Cancer
www.P65Warnings.ca.gov



21774

(Mercedes-Benz: 201-990-05-36)
Black E-Coat

M4.8-1.61 x 20mm (#10 x 25/32")

Hex Head Sems®

Washer Outer Diameter: 26mm

Hex: 8mm

Front Bumper & Moulding Strip
Mercedes-Benz 2014 - 1993

UNIT PACKAGE: 25



25409

(Hyundai & Kia: 12493-06257-E)
Black Zinc

**Phillips Truss Washer Head Tapping
Screw**

M4.8-1.61 x 25mm

Washer Diameter: 16mm

Drive Type: #3 Phillips

Fender Liner & Mud Guard

Hyundai Elantra 2018 - 2011, Ioniq 2019 - 2017,
Palisade 2021 - 2020, Santa Fe 2019 - 2013,
Tucson 2020 - 2009; Kia Cadenza 2020 - 2017,
Forte 2016 - 2014, Forte5 2018 - 2014,
Rio 2017 - 2012, Sportage 2021 - 2010,
Telluride 2021 - 2020

UNIT PACKAGE: 25



23836

Chrome

#10 x 1"

Phillips Oval Head Sems®

Head Size : #8

Hex: 8mm

Point Type : A/AB

UNIT PACKAGE: 100

⚠ WARNING: Reproductive Harm & Cancer
www.P65Warnings.ca.gov



21865

(Chrysler: 6509539-AA)
Phosphate

M4.8-1.61 x 32mm (#10 x 1-1/4")

Hex Head Sems® Tapping Screw

Washer Outer Diameter: 19mm (3/4")

Hex: 8mm

Chrysler Town & Country
and Dodge Ram 2014 - 2009

UNIT PACKAGE: 50



21746

(Mitsubishi: MF453091)
Black Oxide

M5-1.59 x 11mm

Phillips Truss Head

Head Outer Diameter: 11mm

Interior Trim

Mitsubishi Galant 2008 - 2004

UNIT PACKAGE: 50



21747

Black Oxide

M5-1.59 x 11mm

Phillips Round Washer Head

Washer Head Outer Diameter: 12mm

Chrysler & Imports

UNIT PACKAGE: 50



19251

Black Zinc

M5-1.59 x 16mm

Phillips Hex Head Sems®

Washer Outer Diameter: 16mm

Hex: 8mm

UNIT PACKAGE: 50



22294

(Mazda: 9CF600516B)
Black Phosphate

M5-1.81 x 16mm

Phillips Hex Head Sems®

Washer Outer Diameter: 16mm

Hex: 8mm

Mazda 2, 3, 5, 6, 626, 929, CX-5, CX-7, CX-9, Miata,
Millenia, MPV, Mx-3, Protégé, RX-7 & RX-8 2014 - 1992

UNIT PACKAGE: 25



24480

Black Zinc Steel

M5 x 20

Phillips Truss Head w/Loose Washer

Washer Diameter: 16mm

Japanese Cars & Universal

UNIT PACKAGE: 25



22203

(Honda: 90103-SDA-A00)
Black Phosphate

M5-1.81 x 20mm

Phillips Flat Head

Head Diameter: 13mm

Front & Rear Bumper

Honda Civic, Pilot & Ridgeline 2006 - On

UNIT PACKAGE: 100



25317

(BMW: 07-14-9-126-885)
Black Finish

Hex Head Sems Tapping Screw

M5.2-2.12 x 18mm

Hex: 8mm

Washer Diameter: 16mm

Fog Lamp

BMW 228 2021 - 2020, 2016 - 2014, 230, 530, 430, 440,
M240 2020 - 2017, 318 1999 - 1992, 323 2000 - 1998,
325 2006 - 2001, 1995 - 1991, 328 2018 - 1996,
330 2020 - 2017, 2006 - 2001, 540 2020 - 2017,
2003 - 1997, 740 2019 - 2011, 745 2005 - 2002,
750 2019 - 2006, 760 2015 - 2003, 320 2018 - 2013,
2005 - 2001, 1995 - 1993, 335 2016 - 2012, 340 2019 - 2016,
428, 435 2016 - 2014, 525 2003 - 2001,
528 2016 - 2010, 2000 - 1997, 535, 550 2016 - 2010, 640,
650, M6 2019 - 2012, Active Hybrid 3, 5, 7 2016 - 2012,
Alpina 2019 - 2011, 2008 - 2007, i8, X4, X5, X7 2020 - 2019,
M2 2018 - 2016, M235 2021 - 2014,
M3 2018 - 2015, 1999 - 1995, M340 2020, M4 2017 - 2015,
M5 2020 - 2013, 2010 - 2006, M550 2020 - 2018,
M760 2019 - 2017, X1 2021 - 2020, 2015 - 2013,
X3 2021 - 2015, Z4 2008 - 2003

UNIT PACKAGE: 25



25202

(BMW: 07-14-9-213-164)
Black Finish

Hex Head Sems Tapping Screw

M5-2.12 x 20mm

Washer Diameter: 22mm

Hex 8mm

Fender Apron & Bumper Cover

BMW 228i, M235i 2020 - On, 330i, M850i 2019 - On,
528i, 535d, 535i, 550i 2016 - 2011, 530e, 530i, 540d, 540i
2017 - On, 640i, 650i, M6 2019 - 2012, 740,
X3 2011 - On, 750 2009 - On, 760Li 2015 - 2010, 840i,
M340i, M8 2020, Active Hybrid 2016 - 2012, i3, X4,
X6 2015 - On, i8, X5 2014 - On, M5 2013 - On,
M550i 2015 - On, M760i 2017 - On, X1 2016 - On,
X7, Z4 2020 - 2019 Mini Cooper 2014 - On

UNIT PACKAGE: 25



25238

Zinc Dacromet

**Phillips Hex Head Sems®
Tapping Screw**

M5-2.12 x 22mm

Hex: 10mm

Washer Diameter: 18mm

Drive: #3 Phillips

General Purpose

UNIT PACKAGE: 50



21841

(Toyota: 75392-42030)
Black E-Coat

M5.2-2.0 x 20mm (#12 x 25/32")

Phillips Hex Head Sems®

Washer Outer Diameter: 12mm (1/2")

Hex: 8mm

Front Bumper Moulding

Toyota & Lexus 2010 - On

UNIT PACKAGE: 25



21839

(Toyota: 90159-A0001;
90159-50316)
Zinc

M5.2-2.0 x 21mm (#12 x 13/16")

Phillips Hex Head Sems®

Washer Outer Diameter: 14mm (9/16")

Hex: 10mm

Front Bumper, Bumper Stay & Radiator Grille

Toyota & Lexus 2000 - On

UNIT PACKAGE: 25



25395

(BMW: 07-14-7-151-963)
Zinc

Hex Head Sems Tapping Screw

M5-2.12 x 15mm

Hex: 8mm

Washer Diameter: 18mm

Point Type: B

Rocker Moulding

BMW 228i, 428i, 2016 - 2014, 230i 2021 - 2017,
530i, 540i 2017 - On, 740i, M760i, M8 2020 - On,
M550i 2021 - 2018, M850i 2021-2019

UNIT PACKAGE: 25



25397

(BMW: 07-14-9-126-886)

Black Zinc

Hex Head Sems Tapping Screw with Sems Washer

M5-2.12 x 18mm

Washer Diameter: 22mm

Hex: 8mm

Fender Apron & Under Cover

BMW 128i, 135i 2013-2012, 135is 2013, 228i, M235i 2021-2020, 2016-2014, 230i, M240i, 2021-2017, 320i 2018-2013, 328d 2018-2014, 328i, 335i, 528i 2016-2012, 330e 2018-2016, 330i 2019-2017, 340i 2019-2016, 428i, 435i, 535d 2016-2014, 430i, 440i, 2020-2017, 535i, 550i 2017-2010, 740i 2015-2011, 750i, 750Li 2015-2009, 760Li 2015-2010, ActiveHybrid 3, ActiveHybrid 7 2015-2013, ActiveHybrid 5 2015-2012, M2 2021-2016, M3, X4 2018-2015, M4 2020-2015, M5 2016-2013, X1 2021-2013, X2 2018-on, X3, 2021-2011, X6 2014-2008; Mini Cooper 2020-2014, Clubman 2020-2016, Countryman 2020-2017, Paceman 2016-2013

UNIT PACKAGE: 25



25394

(BMW: 07-14-7-146-367)

Black Zinc

Phillips Truss Washer Head Tapping Screw

M5-2.12mm X 18mm

Washer Diameter: 16mm

Point Type: AB

Drive Type: #2 Phillips

Bumper & Fender Apron

BMW 528i, 535i, 550i 2016 - 2011, 535d 2016 - 2014, ActiveHybrid 5 2016 - 2012, M5 2016 - 2013;

Mini Cooper 2015 -2002

UNIT PACKAGE: 25



25203

(BMW: 51-41-7-067-920)

Zinc

Torx Round Washer Head Tapping Screw

M5-2.12 x 16mm

Drive: T20

Washer Diameter: 11mm

Window Reveal Molding & License Plate Bracket

BMW 228i, 840, M235i, M340i, M8, X6 2020 - On, 330i, M850i 2020 - 2019, 428i, 435i 2016 - 2014, 430i, 440i, 530 2017 - On, 535 2017 - 2011, 540 2020 - 2017, 640 2019 - 2012, 650 2017 - 2012, 740 2019 - 2011, 750 2019 - 2016, Active Hybrid 2016 - 2012, i8 2020 - 2014, M4 2020 - 2015, M5, M550i 2020 - 2018, M6 2017 - 2013, 760 2019 - 2017, X3 2020 - 2011, X4, X5 2018 - 2014; Mini Cooper 2015 - 2012, Countryman 2016 - 2012, Paceman 2016 - 2013

UNIT PACKAGE: 50



22111

(VW: N90892001, N90775001)

Black Zinc

M5-2.12 x 19mm (#12 x 3/4") Torx® Truss Head Tapping Screw T25 Drive

Head Diameter: 14mm

Audi, Porsche & VW 2014 - 2007

UNIT PACKAGE: 25



20455

Black Phosphate

M5-2.12 x 20mm (#12 x 25/32")

Phillips Truss Head

Head Outer Diameter: 14mm

Imports

UNIT PACKAGE: 50



22348

(Ford: W702413-S450B,

W702413-S307)

Black Finish

M5-2.2 x 20mm

Torx® Pan Head Sems® Tapping Screw T30 Torx® Drive

Washer Diameter: 20mm

Ford C-Max, Escape, Focus & Transit Connect 2013 - On Ford Edge & F-150 and Lincoln MKC & MKX 2015 - On, Bronco 2021 - On

UNIT PACKAGE: 15



22292

(Nissan: 01454-N5061)

Black Phosphate

M5.5-1.81 x 16mm (#12 x 5/8")

Phillips Truss Head

Head Outer Diameter: 13mm

Fender Liner

Nissan Cube, Murano, Pathfinder, Quest, Rogue, Sentra & Versa 2014 - On, NV200 2013 - On

UNIT PACKAGE: 25



17461

Yellow Zinc Dichromate

M5.5-1.81 x 18mm (#12 x 45/64")

Hex Head Sems®

Washer Outer Diameter: 15mm (19/32")

Hex: 8mm

Imports

UNIT PACKAGE: 50

WARNING: Reproductive Harm & Cancer
www.P65Warnings.ca.gov



25225

Black E-Coat

M5.48-1.81 x 18mm
Hex Head Sems® Tapping Screw

Hex: 8mm
Washer Diameter: 15mm
General Purpose

UNIT PACKAGE: 50



21541

(13144822)
Black Zinc

M5.5 x 20mm (#12 x 25/32")
Torx® Truss Head
T-20 Drive
Head Outer Diameter: 15mm (19/32")

Use with Auveco 21540

GM 2011 - On
Saab 2003 - On

UNIT PACKAGE: 25



25258

(Nissan: 01466-00261)
Zinc

**Bumper Cover Hex Head Tapping
Screw with Sems® Washer**

M6-1.81 x 15mm
Hex: 10mm

Washer Diameter: 18mm
Drive: #3 Phillips

Nissan 350Z 2009 - 2003, 370Z 2009 - On,
Altima, Versa 2007 - On, Armada 2017 - On,
Frontier 2000, GT-R 2015 - 2009, Juke 2017 - 2011,
Kicks 2008 - On, Leaf 2011 - On, Maxima 2000 - On,
Murano 2014 - On, NV1500, NV2500 2013 - 2012,
NV3500 2015 - 2012, Pathfinder, Sentra 2013 - On,
Quest 2017 - 2005, Rouge 2020 - 2008,
Titan 2004 - On, XTrail 2021 - On

UNIT PACKAGE: 25



21744

(Mitsubishi: MS452348)
Black E-Coat

M6-1.81 x 20mm
Phillips Hex Head Sems®
Washer Outer Diameter: 13mm (1/2")
Hex: 10mm

Bumper, Exterior Trim,
Fender Shield and Quarter Panel
Mitsubishi Diamante, Eclipse, Galant, Lancer,
Mirage, Montero & 3000GT 2012 - 1991

UNIT PACKAGE: 25



19170

Black Phosphate

M6.3-1.81 x 16mm (#14 x 5/8")
Phillips Truss Head
Head Outer Diameter: 15mm (19/32")
Japanese Imports

UNIT PACKAGE: 50



15776

(N800312-S2)
Phosphate

M6.3-1.81 x 16mm (#14 x 5/8")
Hex Head Sems®
Washer Outer Diameter: 16mm (5/8")
Hex: 8mm
Ford

UNIT PACKAGE: 50



12057

(11500994)
Phosphate

M6.3-1.81 x 16mm (#14 x 5/8")
Hex Head Sems®
Washer Outer Diameter: 17mm (11/16")
Hex: 10mm
GM

UNIT PACKAGE: 50



22106

(Toyota: 90159-60303)
Zinc

M6.3-2.5 x 18mm
Phillips Hex Head Sems® Tapping Screw

Washer Outer Diameter: 14mm
Hex: 10mm

Toyota & Scion 1993 - On

UNIT PACKAGE: 25



13019

(N610959-S2)
Phosphate

M6.3-1.81 x 19mm (#14 x 3/4")
Hex Washer Head
Washer Outer Diameter: 11.5mm (29/64")
Hex: 8mm
Ford

UNIT PACKAGE: 50



24441

Black Zinc

M6.3-1.81 x 20
Phillips Hex w/Loose Washer

Across Flats: 10mm
Washer Diameter: 13mm
Point Type: AB

UNIT PACKAGE: 50



20556

Black Zinc

M6.3-1.81 x 20mm (#14 x 25/32")
Phillips Hex Head Sems®
Washer Outer Diameter: 16mm (5/8")
Hex: 10mm
Imports

UNIT PACKAGE: 50



12351
(11505022)
Black Phosphate
M6.3-1.81 x 20mm (#14 x 25/32")
Hex Washer Head Sems®
Washer Outer Diameter: 17mm (11/16")
Hex: 10mm
GM

UNIT PACKAGE: 50



16828
Yellow Zinc Dichromate
M6.3-1.81 x 20mm (#14 x 25/32")
Hex Head Sems®
Washer Outer Diameter: 18mm (45/64")
Hex: 10mm
Honda, Nissan, & Toyota

UNIT PACKAGE: 25

WARNING: Reproductive Harm & Cancer
www.P65Warnings.ca.gov



25226
Black E-Coat
M6.3-1.81 x 20mm
Hex Head Sems® Tapping Screw
Hex: 10mm
Washer Diameter: 18mm
General Purpose

UNIT PACKAGE: 25



20557
Black Zinc
M6.3-1.81 x 20mm (#14 x 25/32")
Phillips Hex Head Sems®
Washer Outer Diameter: 20mm (25/32")
Hex: 10mm
Imports

UNIT PACKAGE: 50



24173
(11503412)
Black Zinc
M6.3-1.81 x 20mm (#14 x 25/32")
Hex Head Sems®
Washer Diameter: 23.5mm (25/32")
Across Flats: 10mm
Point Type: A/AB

UNIT PACKAGE: 50



23695
(11502489)
Black
M6.3-1.81 x 22mm
Hex Head Sems®
Washer Outer Diameter: 24mm
Across Flats: 10mm
Point Type: A/AB

UNIT PACKAGE: 50



12339
(11500996, 11505023)
Phosphate
M6.3-1.81 x 25mm (#14 x 1")
Hex Head Sems®
Washer Outer Diameter: 17mm (21/32")
Hex: 10mm
GM

UNIT PACKAGE: 50



24466
(11507083)
Black Steel
M6.3 x 25
Hex Head Screw with Loose Washer
Washer Diameter: 24mm
Across Flats: 10mm
Point Type: AB
GM & Universal

UNIT PACKAGE: 25



12354
(11500997)
Phosphate
M6.3-1.81 x 30mm (#14 x 1-3/16")
Hex Head Sems®
Washer Outer Diameter: 17mm (21/32")
Hex: 10mm
GM

UNIT PACKAGE: 50



12068
(11504981)
Phosphate
M6.3-1.81 x 30mm (#14 x 1-3/16")
Hex Head Sems®
Washer Outer Diameter: 24mm (15/16")
Hex: 10mm
GM

UNIT PACKAGE: 50



25237
Black E-Coat
Phillips Hex Head Sems® Tapping Screw
M6.3-2.5 x 16mm
Hex: 10mm
Washer Diameter: 18mm
Drive: #3 Phillips
General Purpose

UNIT PACKAGE: 50



24442
(11503436)
Black Steel
M6.3 x 35
Hex Head Screw w/Loose Washer
Washer Diameter: 24mm
Point Type: AB
GM & Universal

UNIT PACKAGE: 25



25078

(Lexus & Toyota: 90159-60498,
90159-60603)
Black Dacromet

Phillips Indented Hex Head Sems®

Tapping Screw

M6.3-2.5 x 18mm

Hex: 10mm

Washer Diameter: 16mm

Drive: #3 Phillips

Bumper & Wheel Apron

Lexus ES300h 2018 - 2013, ES350, GS450h 2018-2007,
GS F, RC300 2020 - 2016, GS Turbo 2017,
GS200t, IS200t, RC200t 2017 - 2016, GS300 2019 - 2018 &
2006, GS350 2020 - 2007, GS430 2007 - 2006,
GS460 2011 - 2008, GX460 2021 - 2010,
GX470 2009 - 2003, IS F 2014 - 2008,
IS250, IS350 2015 - 2006, IS300, LX570 2021 - 2016,
LS430 2006 - 2004, LS460 2017 - 2007,
LS600h 2012 - 2008, NX200t 2017 - 2015, NX300, RX350L,
RX450hL 2021 - 2018, RC F, RC350 2021 - 2015,
RX350, RX450h 2022 - 2016
Scion iM 2016, iQ 2015 - 2012, tC 2016 - 2011,
xA 2006 - 2004, Toyota 4Runner 2022 - 2003,
Avalon 2021 - 2019, Corolla 2008 - 2006,
Corolla iM 2018 - 2017, Echo, MR2 Spyder 2005 - 2000,
FJ Cruiser 2014 - 2007, Highlander 2019 - 2014,
Prius 2015 - 2001, Prius Prime 2022 - 2020,
RAV4 2012 - 2006, Sequoia 2021 - 2002,
Tacoma 2021 - 2005, Tundra 2021 - 2004,
Yaris 2018 - 2007

UNIT PACKAGE: 50



21838

(Toyota: 90159-60488)
Zinc

M6.3-2.5 x 24mm (#14 x 15/16")

Phillips Hex Head Sems®

Washer Outer Diameter: 16mm (5/8")

Hex: 10mm

Front Bumper, Bumper Stay, Hood and Front Fender
Lexus CT200, ES350, HS250, IS & SC430,
Scion and Toyota 1995 - On

UNIT PACKAGE: 25



22295

(Hyundai: 12493-06207B)
Black Phosphate

M6.5-1.81 x 18mm

Phillips Truss Head

Head Outer Diameter: 16mm

Fender Liner

Hyundai Accent, Azera, Elantra, Entourage, Genesis, I30,
Santa Fe, Sonata, Tiburon, Tucson, Veloster &
Veracruz 2013 - 2005

UNIT PACKAGE: 25



22296

(Hyundai: 92155-22000;
11254-06206)

Black Phosphate

M6.5-1.81 x 25mm

Phillips Truss Head

Head Outer Diameter: 16mm

Headlamp Assembly Mounting Screw

Hyundai 2000 - On

UNIT PACKAGE: 25



21837

(Toyota: 90159-60525)
Black E-Coat

M6.5-2.5 x 19mm (#14 x 3/4")

Phillips Hex Head Sems®

Washer Outer Diameter: 20mm (25/32")

Hex: 10mm

Floor Pan & Lower Back Panel Moulding, Rear Bumper
Stay, Suspension Cross Member and Under Cover
Toyota 1998 - On

UNIT PACKAGE: 25

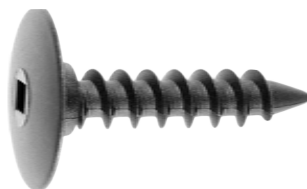

19417

(Chry: 6503819, 6503401;
GM: 25631448)
Black Nylon

M7.5 x 35mm

Square Drive Truss Head

Head Diameter: 22mm

Shoulder Diameter: 9mm

Foam to Bumper Fascia

Chrysler 1993-On

GM 1997 - On

UNIT PACKAGE: 15



12350

(11500086)
Phosphate

M8-2.12 x 20mm (5/16"-12 x 25/32")

Hex Washer Head

Washer Head Outer Diameter: 16mm (5/8")

Hex: 13mm

GM

UNIT PACKAGE: 25

21517
(25705182)
Black Nylon



M9.5 x 46mm
Square Drive Truss Head
Head Diameter: 22mm
GM

UNIT PACKAGE: 25

20970
(Not Available from O.E.M.)
Black Nylon



M14 x 34mm
Bumper and Door Insulator Nylon Screw
No. 3 Square Drive
Head Outer Diameter: 22mm
Fits into 12mm Hole
GM, Ford & Chrysler 2005 - On

UNIT PACKAGE: 25

16986
(14003784)
Zinc



M8-1.25 x 25mm
Stainless Steel Capped Pan Head without Nuts
Head Diameter: 19mm
Shoulder Length: 3mm
GM

UNIT PACKAGE: 25

11404
(N14-4003)
Plain



M8-1.25 x 35mm
Class 4.8
Volkswagen Intake Manifold

UNIT PACKAGE: 25

17559

Yellow Zinc Dichromate



M10-1.25 x 42mm
Class 8.8
Exhaust Systems
Honda, Nissan & Toyota

UNIT PACKAGE: 10

WARNING: Reproductive Harm & Cancer
www.P65Warnings.ca.gov

17560

Yellow Zinc Dichromate

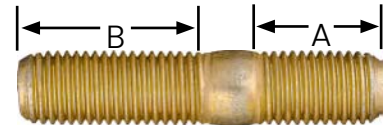

M10-1.25 x 48mm
Dim. A: 15mm Dim. B: 25mm
Class 8.8
Exhaust Systems
Honda, Nissan & Toyota

UNIT PACKAGE: 10

WARNING: Reproductive Harm & Cancer
www.P65Warnings.ca.gov

17596

Yellow Zinc Dichromate



M12-1.25 x 50mm
Class 8.8
Catalytic Converter
Mazda

UNIT PACKAGE: 5

WARNING: Reproductive Harm & Cancer
www.P65Warnings.ca.gov

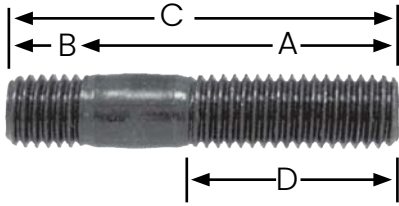

Cylinder Head and Manifold Metric Studs
Grade 8 Medium Carbon Heat Treated Alloy Steel
Regular Pitch

Auveco Part No.	A Diameter & Length	B Diameter & Length	C Overall Length	D Length	Unit Pkg.
11973	6mm-1.00 x 20mm	6mm-1.00 x 7.5mm	27.5mm	18mm	10
11974	6mm-1.00 x 25mm	6mm-1.00 x 7.5mm	32.5mm	18mm	10
11980	8mm-1.25 x 20mm	8mm-1.25 x 10mm	30.0mm	16mm	10
11981	8mm-1.25 x 25mm	8mm-1.25 x 10mm	35.0mm	22mm	10
11982	8mm-1.25 x 30mm	8mm-1.25 x 10mm	40.0mm	22mm	10
11983	8mm-1.25 x 35mm	8mm-1.25 x 10mm	45.0mm	22mm	10
11984	8mm-1.25 x 40mm	8mm-1.25 x 10mm	50.0mm	22mm	10
11987	8mm-1.25 x 55mm	8mm-1.25 x 10mm	65.0mm	22mm	10
11989	10mm-1.50 x 30mm	10mm-1.50 x 12mm	42.0mm	18mm	10
11990	10mm-1.50 x 35mm	10mm-1.50 x 12mm	47.0mm	26mm	10
11991	10mm-1.50 x 40mm	10mm-1.50 x 12mm	52.0mm	26mm	10
11995	10mm-1.50 x 65mm	10mm-1.50 x 12mm	77.0mm	26mm	5
11998	12mm-1.75 x 30mm	12mm-1.75 x 15mm	45.0mm	25mm	5

24545
(20625733)
Metal



Threaded Cutting Nut
Bolt Size: M5-1.6
Flange Diameter: 14mm
Across Flats: 10mm
Dacromet Finish
GM

UNIT PACKAGE: 50



Washer Type Metric Self-Threading Nuts



Auveco Part No.	Stud Size	Hex Width	Washer Diameter	Finish	O.E.M. Number	Unit Pkg.
12115	4mm	9mm	15mm	Zinc	11502549	100
12253	5mm	10mm	15mm	Phosphate	11501835, 10062, W707501-S300	50
16829	6mm	11mm	18mm	Zinc	6100815	100
12117	6.3mm	11mm	18mm	Zinc	11503432	50
12255	6.3mm	11mm	18mm	Zinc	11501836	50
15711	8mm	13mm	20mm	Zinc	11502507, 11509535, 11514282	100
22913	5mm	10mm		Zinc	W706675-S439	50



Regular Pitch Metric Hex Nuts DIN 934

Class 8 • Steel • Zinc Plated
Tensile Strength: 116,000 Max.

Auveco Part No.	Size	Pitch (mm)	Hex Width	Unit Pkg.
10569	4mm	.70	7mm	25
14448	4mm	.70	7mm	50
10570	5mm	.80	8mm	25
14449	5mm	.80	8mm	50
10571	6mm	1.00	10mm	25
14450	6mm	1.00	10mm	100
10572	7mm	1.00	11mm	25
14451	7mm	1.00	11mm	50
10573	8mm	1.25	13mm	25
14452	8mm	1.25	13mm	100
10575	10mm	1.50	17mm	10
14454	10mm	1.50	17mm	50
10576	12mm	1.75	19mm	10
14455	12mm	1.75	19mm	25
14625	14mm	2.00	22mm	25
14626	16mm	2.00	24mm	25



J.I.S. Small Hex Nuts J.I.S. B1181 • I.S.O. Class 8 Steel • Heat Treated Zinc Plated

Auveco Part No.	Size	Pitch (mm)	Hex Width	Unit Pkg.
14796	8mm	1.25	12mm	25
14797	10mm	1.25	14mm	15
17392	10mm	1.25	14mm	50
16617	12mm	1.25	17mm	25



Fine Pitch Metric Hex Nuts DIN 934

Class 8 • Steel • Zinc Plated
Tensile Strength: 116,000 Max.

Auveco Part No.	Size	Pitch (mm)	Hex Width	Unit Pkg.
10574	8mm	1.00	13mm	25
14453	8mm	1.00	13mm	50
11277	10mm	1.00	17mm	10
14456	10mm	1.00	17mm	25
11278	10mm	1.25	17mm	10
14457	10mm	1.25	17mm	25
11279	12mm	1.25	19mm	10
14458	12mm	1.25	19mm	25
11280	12mm	1.50	19mm	10
14459	12mm	1.50	19mm	25
21426	14mm	1.50	22mm	10



Metric Nylon Insert Lock Nuts DIN 985

Heat Treated Alloy Steel
Zinc Plated

Auveco Part No.	Size	Pitch (mm)	Hex Width	Unit Pkg.
11049	4mm	.70	7mm	100
11051	5mm	.80	8mm	100
11053	6mm	1.00	10mm	100
11055	8mm	1.25	13mm	100
11057	10mm	1.50	17mm	100
11059	12mm	1.75	19mm	100



Metric Flange Lock Nuts



Auveco Part No.	Thread Size	Flange O.D.	Hex Size	Height	Plating	O.E.M. No.	Unit Pkg.
23693	M8	18mm	13mm		Zinc	11507036	50
11709	M8-1.25	17mm	13mm	8.5mm	Zinc	11502811	50
11708	M10-1.5	21mm	15mm	11.5mm	Zinc	11502812	25
14521	M10-1.5	21mm	15mm	12mm	Phosphate		25



Metric Hex Flange Nuts



Auveco Part No.	Thread Size	Flange O.D.	Hex Size	Height	Plating	O.E.M. No.	Unit Pkg.	
16880	M4-.7	11mm	7mm	5mm	Black Zinc	14031900	50	
17495*	M4-.7	14mm	9mm	6mm	Zinc	N620391-S36	50	
19309	M5-.8	11.5mm	8mm	5mm	Black Oxide		50	
19308	M5-.8	11.5mm	8mm	5mm	Zinc	11502702	50	
19205	M6-1.0	14mm	10mm	6mm	Phosphate	11503745, 01225-N6011	100	
11644	M8-1.25	17mm	13mm	8mm	Phosphate	11501889,	25	
16269	Same as 11644 except for unit package quantity						11502609 11507036	50
24105	M8	18mm			Zinc		50	
18253▲	M10-1.25	19mm	14mm	9mm	Yellow Zinc		50	
11645	M10-1.5	21mm	15mm	10mm	Phosphate	11501850	25	
20606	M12-1.75	25mm	18mm	12mm	Phosphate		25	

*with Sealer



Type A



Type B

Metric Free Spinning Washer Nuts

Auveco Part No.	Thread Size	Type	Washer O.D.	Hex Size	Height	Plating	O.E.M. No.	Unit Pkg.
15325	M4-0.7	B	12mm	9mm	4.5mm	Phosphate	N621900, N800466	50
16883	M5-0.8	B	10mm	8mm	7mm	Yellow Zinc	N802775-S36	50
15326	M5-0.8	B	15mm	10mm	7mm	Phosphate	N621903	50
15327	M5-0.8	B	19mm	10mm	7mm	Phosphate	11504614	50
19216	M6-1.0	B	14mm	10mm	8mm	Phosphate	6100047	50
12595	M6-1.0	A	16mm	10mm	7mm	Phosphate	11505329, 11503752, N90100001	25
23684	M6-1.0	B	16mm			Black	N90100001 11505329	50
15328	M6-1.0	B	16mm	11mm	8.5mm	Phosphate	N621905	50
15329	M6-1.0	B	18mm	10mm	9mm	Phosphate	6100048	50
12596	M6-1.0	A	19mm	11mm	9.5mm	Phosphate	11503754, 11503756	25
23685	M6-1.0	B	19mm	10mm	9.5mm	Phosphate	11609411 N621906S441	50
15330	M6-1.0	B	19mm	10mm	8mm	Zinc	N621906S2 11508275	50
24426	M6	B	19mm	10mm	9.5mm	Phosphate	11503754 11503756 11505214 6100049	25
16774▲	M6-1.0	B	19mm	11mm	9mm	Yellow Zinc	N621906-S36	50
22947	M6-1.0	B		10mm	7mm	Black	11546449	25
23686	M6-1.0	B	24mm	11mm		Black	N621907S250	
15331	M6-1.0	B	20mm	10mm	9mm	Phosphate	6100049	50
15332▲	M6-1.0	B	24mm	11mm	9mm	Yellow Zinc	N621907	25
24434	M6	B	24mm	11mm		Zinc	N621907-S55	25
23655	M6.3-1.0	B	19mm	11mm		Black		
15333	M8-1.25	B	18mm	13mm	10mm	Phosphate	6100050	25
15334	M8-1.25	B	19mm	13mm	10mm	Phosphate	11501800	25
15335▲	M8-1.25	B	24mm	13mm	10.5mm	Phosphate	11503695, 11506117, N621940	25
23656	M8-1.25	A	24mm	13mm		Black	N621940S424 11516780	50
15337	M10-1.5	B	24mm	15mm	13mm	Phosphate	N621942	25

▲WARNING: Reproductive Harm & Cancer www.P65Warnings.ca.gov



LOCKONE

Fast & easy to install-no special tools required
 Corrosion resistant, 304 Stainless Steel
 Reusable, does not degrade with each cycle
 Vibration-Proof, positive locking force
 Designed for harsh environments
 Ideal for weight sensitive applications

Auveco Part No.	Thread Size	Hex	Metric Sizes Thickness	Wire Width	Weight	Unit Pkg.
22870	M6-1.0	10	2.0	.70	0.45 g	10
22871	M8-1.25	13	2.5	.88	0.95 g	10
22872	M10-1.5	17	3.0	1.05	1.79 g	10
22873	M12-1.75	19	3.5	1.23	2.83 g	10

Fractional LockOne can be found on page 35



Metric Spin Lock Nuts with Serrations
Case Hardened



Auveco Part No.	Thread Size	Flange O.D.	Hex Size	Plating	Unit Pkg.
Standard Flange Black Steel					
24430	M5	11.5mm	8mm	Steel	50
16769	M6-1.0	14mm	10mm	Zinc	50
16830	M8-1.25	17mm	12mm	Zinc	50
16470	M10-1.25	19mm	14mm	Zinc	25
Large Flange					
14855	M6-1.0	17mm	10mm	Phos	100
14856	M8-1.25	19mm	13mm	Phos	100
22045	M10-1.50	20mm	15mm	Zinc	25



Nylon Coated Acorn Nuts

Auveco Part No.	Size	Hex	Height	Unit Pkg.
20570	M4-0.7	10mm	11mm	15



Metric Wing Nuts
DIN D00213
Zinc Plated

Auveco Part No.	Thread Size	Unit Pkg.
17010	M6-1.0	25
23671	M8-1.25	50



Metric Push-On Retainers
For Non-Threaded Fasteners

Auveco Part No.	Stud Size	Diameter	Finish	Unit Pkg.
12118	3.2mm	9.5mm	Zinc	100
12119	4mm	11mm	Zinc	100
23530	5mm	11mm	Black	100



Metric Pushnut Bolt Retainers
For Threaded Fasteners

Auveco Part No.	Thread Size	O.D.	Finish	Unit Pkg.
12122	M5-0.8	11mm	Zinc	100
12123	M6-1.0	13mm	Zinc	100
14980	M6-1.0	17mm	Zinc	100
12124	M6.3-1.0	13mm	Zinc	100
12125	M8-1.25	16mm	Zinc	100
12259	M8-1.25	24mm	Zinc	50
12126	M10-1.50	20mm	Phosphate	50
12260	M10-1.50	24mm	Zinc	100
12127	M12-1.75	21mm	Zinc	50
22801	M12	21mm	Phosphate	100
16980	M14-2.0	25mm	Plain	50

**PLEASE ORDER ITEMS IN
UNIT PACKAGE QUANTITIES
AND
BY NUMBER OF PIECES NEEDED**

TUBULAR TYPE NUTS



20472
(91512-SR3-004)
White Nylon

Tubular Nut with Sealer & Sealed End
For 3mm Stud
Fits into 6mm Hole
Head Diameter: 8.5mm

UNIT PACKAGE: 10



13170
(5131-I-802-258)
Natural Nylon

For 7mm Stud
Fits into 8mm hole
Overall Length: 20mm

UNIT PACKAGE: 50

CAGE NUTS



23979

Black Finish

Screw Size: M5-0.80
Hole Size : 0.343-0.380"
Outer Diameter : 13.2mm
Panel Range : 2.4-3.2mm

UNIT PACKAGE: 50



16142

Zinc

Screw Size: M6-1.0
Panel Range: 1.7mm-2.7mm

UNIT PACKAGE: 25

U & J NUTS BY SCREW SIZE



20649

Zinc

Screw Size: 3.5mm (#6)
Panel Range: .5mm - 1.5mm
Center of Hole to Edge: 8mm

UNIT PACKAGE: 50



13224

(000-994-04-45)

Zinc

Screw Size: 4.2mm (#8)
Panel Range: .5mm-1.7mm
Center of Hole to Edge: 8mm

UNIT PACKAGE: 50



13223

(BMW: 0712-9-925-708;
Mercedes: 000-994-25-45)
Zinc

Screw Size: 4.2mm (#8)
Panel Range: 3mm-4mm
Center of Hole to Edge: 7mm

UNIT PACKAGE: 50



25233

Yellow Zinc

Spring Type U-Nut
Screw Size: M4.2 (#8)

Width: 11mm
Length: 16mm

Panel Range: 0.6mm-2.5mm
Center of Hole to Edge: 7.5mm
General Purpose

UNIT PACKAGE: 50



13225

Zinc

Screw Size: 4.2mm (#8)
Panel Range: .5mm-2.5mm
Center of Hole to Edge: 8mm

UNIT PACKAGE: 50



23852

(000-994-04-05)

Yellow Zinc

Screw Size: M4.2-1.41 (#8)
Length: 16mm
Width: 11.2mm

Panel Range: 0.5mm - 1.7mm
Center of Hole to Edge: 8mm

UNIT PACKAGE: 50



25234

Yellow Zinc

Spring Type U-Nut

Screw Size: M4.2 (#8)

Width: 11mm

Length: 17mm

Panel Range: 0.3mm-2.5mm

Center of Hole to Edge: 9mm

General Purpose



UNIT PACKAGE: 50



25342

(BMW: 07-14-6-951-655)

Finish: Silver Zinc

Metric U-Nut

Screw Size: M4.2-1.41 (#8)

Panel Range: 0.8mm Max

Center of Hole To Edge: 9mm

Width: 15mm

Length: 18mm

Bumper

BMW 1 Series M 2011, 128, 135 2013 - 2008, 325, 330 2006,
328 2013 - 2007, 335 2011 - 2007, 535 2017 - 2010,
550 2015 - 2010, 640, 650, M6 2019 - 2012, i3 2020 - 2014,
M3 2018 - 2008, M4 2020 - 2015, X1 2015 - 2013,
X3 2021 - 2007, X4 2020 - 2008, X6 2021 - 2008,
X7 2020 - 2019, Z4 2016-2009

UNIT PACKAGE: 25



22847

(BMW: 07-14-7-311-312)

Natural Nylon

Rocker & Fender Moulding U-Nut

Screw Size: M4.2 (#8)

Width: 15mm

Length: 22mm

Height: 13.5mm

Panel Range: 1mm

Center of Hole to Edge: 11mm

BMW 428i, 428i Gran Coupe, 430i, 430i Gran Coupe,
435i, 435i Gran Coupe, 440i, 440i Gran Coupe,
528i, 530e, 530i, 535d, 535i, 535i GT,
540i, 550i, 550i GT, 640i, 640i Gran Coupe,
650i, 650i Gran Coupe, 740Ld, 740Li, 740i,
750Li, 750i, 760Li, Active Hybrid 5 & 7, M4, M5,
M550i, M6, M6 Gran Coupe, M760i, X1, X2, X3,
X5, X6, i3, i3s & i8 2012 - On
Mini Cooper, Clubman & Countryman 2014 - On

UNIT PACKAGE: 25





25035

(Smart/Mercedes: 001-991-39-70)
Yellow Nylon

U-Nut

Screw Size: M4.2 (#8)
Width: 18mm
Length: 35mm
Panel Range: 3mm
Center of Hole to Edge: 15mm
Smart Car Fortwo 2015 - 2008

UNIT PACKAGE: 25



25315

(BMW: 07-12-9-904-223)
Zinc

Bumper Cover U-Nut

Screw Size: M4.8-1.61 (#10)
Panel Range: 1.5mm
Center of Hole To Edge: 7mm
Width: 15mm
Length: 16mm

BMW 318 1998 - 1994, 323 1999 - 1998,
325 2006, 1995 - 1994, 328 2009 - 2007, 1999 - 1996,
330 2006, 335 2009 - 2007, 528 2016 - 2011,
740 2015 - 2011, 750 2015 - 2009, 760 2015 - 2010,
1 Series 2011, 128, 135 2013 - 2008,
535, 550 2017 - 2010, 640, 650 2015 - 2012,
Active Hybrid 5 2016 - 2012, M3 2013 - 2008, 1999 - 1995,
M5 2016 - 2013, X3 2017 - 2011, Z3 2002 - 1996,
Z4 2008 - 2003

UNIT PACKAGE: 25



13216

Zinc

Screw Size: 4.8mm (#10)
Panel Range: .9mm-2mm
Center of Hole to Edge: 8mm

UNIT PACKAGE: 25



13215

Zinc

Screw Size: 4.8mm (#10)
Panel Range: .8mm-1.7mm
Center of Hole to Edge: 11mm

UNIT PACKAGE: 50



13218

Yellow Zinc

Screw Size: 4.8mm (#10)
Panel Range: .5mm-1.7mm
Center of Hole to Edge: 7mm

UNIT PACKAGE: 50

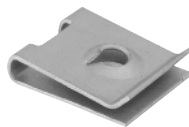

25261

(Audi: WHT-005-296)
Zinc

Fender Apron & Under Cover U-Nut

Screw Size: M4.8-1.61 (#10)
Panel Range: 1.5mm-2.5mm
Center of Hole To Edge: 11mm
Width: 16mm
Length: 19mm
Audi A3, S3 2015 - On, A4 2017 - On, A5,
S4, S5 2018 - On, A6, A7, A8, e-tron,
RS5 2019 - On, Q3 2018 - 2015,
S6, S7, S8 2020 - On, TT, TTS 2016 - On

UNIT PACKAGE: 25

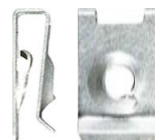

22114

(BMW: 07129904150)
Zinc Finish

U Type Nut

Screw Size: M4.8 (#10)
Panel Range: 2.3mm - 3.5mm (.090"-.138")
Center of Hole to Edge: 8.5mm
BMW 2011 - 1992

UNIT PACKAGE: 25

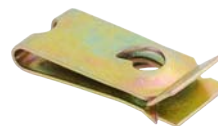

25232

Yellow Zinc

Spring Type U-Nut

Screw Size: M4.8 (#10)
Width: 11mm
Length: 25mm
Panel Range: 0.8mm-2.5mm
Center of Hole to Edge: 16mm
General Purpose

UNIT PACKAGE: 50



25235

Black E-Coat

Spring Type U-Nut

Screw Size: M4.8 (#10)
Width: 16mm
Length: 21.5mm
Panel Range: 0.8mm-3mm
Center of Hole to Edge: 10mm
General Purpose

UNIT PACKAGE: 25



21017

(Nissan: 76882-0M000)
White Nylon

Screw Size: 4.8mm (#10)
Panel Range: Up to 1.5mm
Center of Hole to Edge: 8mm

UNIT PACKAGE: 15

U & J NUTS BY SCREW SIZE



14750

Black Nylon

Screw Size: 4.8mm (#10)
Panel Range: Up to 1mm
Center of Hole to Edge: 11mm

UNIT PACKAGE: 15

19669

Same as 14750 except for unit package quantity

UNIT PACKAGE: 25



17993

Black Nylon

Screw Size: 4.8mm (#10)
Panel Range: Up to 3mm
Center of Hole to Edge: 14mm

UNIT PACKAGE: 10



19735

(Nissan: 63848-35F00)
Black Nylon

Screw Size: 4.8mm (#10)
Panel Range: Up to 2mm
Center of Hole to Edge: 8mm

UNIT PACKAGE: 15



21359

(Toyota: 53879-17020)
Black Nylon

Screw Size: M4.8 (#10)
Panel Range: Up to 2mm
Center of Hole to Edge: 10mm

UNIT PACKAGE: 10



23945

(90467-04023)
Black Nylon

**Nylon U-Nut
Fender Apron**
Screw Size: M4.8 (#10)
Width: 20mm
Length: 28mm
Toyota Camry 2000

UNIT PACKAGE: 25

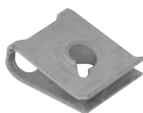

25250

(Acura & Honda: 90331-S3Y-003)
Zinc

Bumper & Wheel Apron U-Nut

Screw Size: M5
Panel Range: 2.0mm-3.5mm
Center of Hole To Edge: 8.0mm
Width: 11.0mm
Length: 14.5mm
Acura ILX 2016 - 2013, NSX 2020 - 2017,
RDX 2007 - On, RL 2012 - 2009,
RLX 2014 - On, TL & TSX 2014 - 2004,
TLX 2015-On; Honda Accord 2011 - On,
Civic 2009 - On, Clarity 2017 - On,
Crosstour 2015 - 2010, CR-V 2005 - On,
Element 2008, Fit 2013 - 2012,
HR-V 2016 - On, Insight 2000 - On,
S2000 2009 - 2008

UNIT PACKAGE: 50



25228

Zinc

Spring Type U-Nut

Screw Size: M5
Width: 13mm
Length: 20mm
Panel Range: 0.8mm-2.5mm
Center of Hole to Edge: 10mm
General Purpose

UNIT PACKAGE: 50



22822

(Audi: WHT-006-099,
BMW: 07-14-7-212-877)
Yellow Nylon

Bumper Cover U-Nut

Screw Size: M5
Panel Range: 2.5mm Max.
Center of Hole to Edge: 8mm
Audi A3, S3 2020 - 2017, A4, S4 2021 - 2013, A5 Quattro, TT
RS Quattro 2020 - 2018, A5 Sportback, S5 2022 - 2018,
A6 allroad 2021 - 2020, A6 Quattro, A7 Quattro, e-tron
Quattro, Q8 2020 - 2019, allroad 2016 - 2013,
Q3, RS5 2022 - 2019, Q5, SQ5 2021 - 2018, Q7 2022 - 2017,
RS Q8, S7 2020, S6, SQ7 2022 - 2020, SQ8 2021 - 2020, TT
Quattro, TTS Quattro 2020 -2016; BMW 535i GT, 550i GT,
640i, 640iGran Coupe, 650i, 650i Gran Coupe,
740e, 740i, 750i, M6 & X6 2017 - On

UNIT PACKAGE: 25

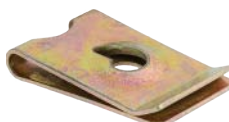

25231

Yellow Zinc

Spring Type U-Nut

Screw Size: M5.5 (#12)
Width: 14.5mm
Length: 26mm
Panel Range: 0.8mm-2.5mm
Center of Hole to Edge: 13.5mm
General Purpose

UNIT PACKAGE: 50





13162

Zinc

Screw Size: 5.6mm
Panel Range: 1.2mm-2.0mm
Center of Hole to Edge: 10mm

UNIT PACKAGE: 50



21540

(GM: 24449408)
Orange Nylon

Screw Size: M5.5 (#12)
Panel Range: Up to 2mm (5/64")
Center of Hole to Edge: 12mm (15/32")

Use with Auveco 21541

UNIT PACKAGE: 25



20956

(Toyota: 90467-05114)
Black Nylon

Screw Size: 5.5mm (#12)
Panel Range: Up to 1mm
Center of Hole to Edge: 14mm

UNIT PACKAGE: 10



17193

(Nissan: 01241-00551, 63848-D0100)
Nylon

Screw Size: 5.6mm (#12)
Panel Range: Up to 1mm
Center of Hole to Edge: 9mm

UNIT PACKAGE: 15



17385

(Nissan: 63848-D4000)
Black Nylon

Screw Size: 5.6mm (#12)
Panel Range: Up to 2mm
Center of Hole to Edge: 9mm

UNIT PACKAGE: 10

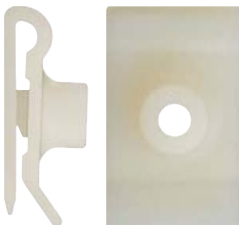

24522

(90467-04009)
Natural Nylon

U-Nut
Overall Length: 30mm
Overall Width: 18mm
Toyota

UNIT PACKAGE: 10

24523

Same as 24522 (2894) except for
unit package quantity

UNIT PACKAGE: 25

25057
(Mercedes: 000-990-32-62)
Black Nylon

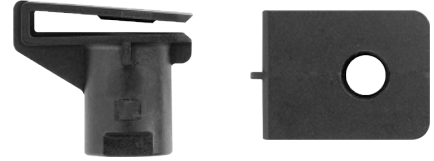

Bumper Pipe Shield Extension U-Nut

Screw Size: M6
Width: 17mm
Length: 23.7mm
Panel Range: 3mm Max.
Center of Hole to Edge: 12mm
Mercedes CLS400 2018 - 2015;
CLS550, CLS63 AMG 2018 - 2012;
E250, E350 2016 - 2014;
E400 2017 - 2014; E550 2017 - 2010;
E63 AMG 2016 - 2014; GL350, GL460, GL 550
2012 - 2010; GLC300 2019 - 2016; GLC350e
2019 - 2018; GLC43 AMG 2019 - 2017;
GLC63 AMG 2019 - 2018; GLE43 AMG 2019 - 2017;
GLE450 AMG 2016; GLE63 AMG 2019 - 2016;
GLK250, GLK350 2015 - 2013

UNIT PACKAGE: 25



14750

Black Nylon

Screw Size: 4.8mm (#10)
Panel Range: Up to 1mm
Center of Hole to Edge: 11mm

UNIT PACKAGE: 15

19669

Same as 14750 except for unit package quantity

UNIT PACKAGE: 25



21614

(Toyota: 90467-05128)
White Nylon

Screw Size: M6 (#14)
Panel Range: Up to 2mm
Center of Hole to Edge: 12mm

UNIT PACKAGE: 15



21615

(Toyota: 90467-A0018,
90467-05081)
Maroon Nylon

Screw Size: M6 (#14)
Panel Range: Up to 2mm
Center of Hole to Edge: 12mm

UNIT PACKAGE: 15

U & J NUTS BY SCREW SIZE



21378
 (Hyundai: 86825-28000)
 Black Nylon
 Screw Size: M6 (#14)
 Panel Range: Up to 1.5mm
 Center of Hole to Edge: 8mm

UNIT PACKAGE: 25



25229
 Yellow Zinc
Spring Type J-Nut
 Screw Size: M6.3 (#14)
 Width: 15mm
 Length: 24mm
 Panel Range: 0.8mm-1.5mm
 Center of Hole to Edge: 13mm
 General Purpose

UNIT PACKAGE: 50



25230
 Yellow Zinc
Spring Type U-Nut
 Screw Size: M6.3 (#14)
 Width: 16mm
 Length: 25mm
 Panel Range: 0.8mm-3mm
 Center of Hole to Edge: 13mm
 General Purpose

UNIT PACKAGE: 50



13220
 (Mercedes: 000-994-09-14;
 Volvo: 946-418; Opel: 20-72-175)
 Yellow Zinc
 Screw Size: 6.5mm (#14)
 Panel Range: .7mm-1.5mm
 Center of Hole to Edge: 13mm

UNIT PACKAGE: 50



14276
 (Toyota: 53879-22010)
 Black Nylon
 Screw Size: 6.3mm (#14)
 Panel Range: Up to 1mm
 Center of Hole to Edge: 15mm

UNIT PACKAGE: 15



21459
 (Nissan: 01241-00881)
 Black Nylon with Captive Metal
Hex Nut
 Thread: M6 - 1.0
 Panel Range: Up to 4mm
 Center of Hole to Edge: 14mm

UNIT PACKAGE: 10



25092
 (Infiniti & Nissan: 01241-01051)
Black Nylon & Black Metal Nut License Plate Bracket U-Nut with Encapsulated Hex Nut
 Screw Size: M6-1.0
 Width: 16mm
 Length: 28mm
 Panel Range: 3.5mm
 Center of Hole To Edge: 13.5mm
 Infiniti G35 2007 - 2004, G37 2013 - 2009, M35, M45 2009- 2006, Q60 2015 - 2014, Q70 2019 - 2014, QX50 2017 - On, QX80 2019 - 2017
 Nissan 350Z 2009 - 2003; 370Z 2009 - On, Armada 2017 - On, Cube 2014 - 2009, Frontier 2019 - 2013, Leaf 2017 - 2011, Pathfinder 1999 - 1996, Rouge 2013 - 2009, Sentra 2018 - 2013, Versa 2019 - 2007

UNIT PACKAGE: 25

METRIC EXTRUDED U-NUTS

Fold Over Nuts



Auveco Part No.	Screw Size	"A" Panel Range		"B" Foldover Clear		O.E.M. Finish	No.	Unit Pkg.
		mm	Inches	mm	Inches			
18337	M4-.7	0.60-3.80	1/32-5/32	9.5	3/8	Zinc Organic	11500654, N623330-S2	50
11625	M4-.7	0.80-4.00	1/32-5/32	13.5	17/32	Phosphate	11500655	50
20339	M4.2-1.41*	0.50-2.00	1/32-5/64	10	25/64	Zinc Organic	11516397, W707291-S439	50
21040	M4.2-1.41*	0.65-3.80	1/32-5/32	9.5	3/8	Zinc Organic	11513599 W704823-S439	25
22074	M 4.2-1.41*	0.65-3.80	1/32-5/32	15		Zinc Organic	11515638	25
22702	M4.2-1.41	2.0-3.4	.079-.137	9.5	3/8	Silver Zinc Organic	W708991-S439	25
22582	M4.2-1.41	2.0-3	.078-.118	9.5	3/8	Zinc Organic	11548579	25
22583	M4.2-1.41	0.65-3.8	.026-.149	15	19/32	Zinc Organic	11548580	25
22578	M4.8-1.6	0.61-3.8	.024-.149	11.5	.452	Zinc Organic	6509799-AA	25
22113	M5-.8	0.45-1.5	1/64-1/16	11.5		Zinc Finish	51127070202, N90168602	25
18338	M5-.8	0.60-3.80	1/32-5/32	11	7/16	Phosphate	11505596, N623331-S2	50
11626	M5-.8	0.80-4.00	1/32-5/32	15.8	5/8	Phosphate	11500657	50
22841	M6-1.0	0.50 Max	.0197	11.5mm	0.452	Zinc Organic	51-12-7-070-202	25
25077	M6-1.0	1.8-2.5	.071-.098	9mm	0.354	Zinc Organic	1151784115 N806728S439	15
25188	M6-1.0	1.8-2.0				9.2mm	68073566AA15	
22539	M6-1.0	0.5-4.00	.0197-.157	13	0.512	Magni-554 Silver	6105242-AA	25
22865	M6-1.0	0.7-2.0	.0276-.078	12mm	0.472	Zinc Organic	W712324-S439	10
16846	M6-1.0*	0.80-4.00	1/32-5/32	12	15/32	Phosphate	6502152	50
16842	M6-1.0	3.40-6.30	9/64-1/4	13.5	17/32	Phosphate	11504047, N802331-S53	25
18449	M6-1.0*	0.80-4.00	1/32-5/32	13.5	17/32	Phosphate	6101308	50
11864	M6-1.0	0.80-4.00	1/32-5/32	13.5	17/32	Phosphate	11503714, 11503716	50
12669	M6-1.0	0.80-4.00	1/32-5/32	13.5	17/32	Phosphate	1016937, 12337917, 11503957, N623332-S2, -S53 & S-100 W520822-S426	25
22584	M6-1.0	.80mm-4.00mm	.030-.160	13.5	17/32	Zinc Organic	W520802-S439 01241-0009U	25
22579	M6-1.0	0.80-4.00	1/32-5/32.	13.5	17/32	Zinc Organic	W520822-S439 6510185-AA 6101956 6503694	25
22581	M6-1.0	0.70-2.0		14		Zinc Organic	11611321	10
22837	M6-1.0	0.5-2.3	0.019-0.090	14.5	9/16	Zinc Organic	W705958-S439	10
22105	M6-1.0	2.00-4.00	5/64-5/32	14.5	9/16	Zinc	90675-SA5-003	25
12666	M6-1.0	3.40-6.30	9/64-1/4	14.5	9/16	Zinc Organic	11504978	25
20416	M6-1.0	2.00-5.00	5/64-3/16	14.5	9/16	Zinc Organic	11516372	25
25411	M6-1.0	4mm		15mm		Silver	GSIE56496A	25

(Continued on next page)



Auveco Part No.	Screw Size	"A" Panel Range		"B" Foldover Clear		O.E.M. Finish	Unit No.	Pkg.
		mm	Inches	mm	Inches			
12575	M6-1.0	0.80-4.00	1/32-5/32	19.5	25/32	Phosphate	11503715	25
16322	M6-1.0	1.00-2.50	3/64-3/32	19.5	25/32	Phosphate	14040999	50
19480	M6-1.0	4.30-5.60	11/64-7/32	21.0	13/16	Phosphate	N805889-S100	15
11628	M6.3-1.0	0.80-4.00	1/32-5/32	13.5	17/32	Phosphate	11500658	25
11629	M8-1.25	0.80-4.00	1/32-5/32	14.5	9/16	Phosphate	11500660, 11502617, N623333-S2	25
11630	M8-1.25	0.80-4.00	1/32-5/32	20	13/16	Phosphate	11500661, 11503317, N623343-S2	25
22700	M8-1.25	0.80-4.00	.030-.160	14.5	9/16	Zinc	N800296-S439 W520823-S439	15
22838	M8-1.25	0.80-4.00	.030-.160	15		Zinc Organic	11548585	15
22699	M8-1.25	0.80-4.00	.030-.160	21	13/16	Zinc	W520813-S439 11516150	15
12667	M8-1.25	1.50-5.50	1/16-7/32	14.5	9/16	Zinc Organic	11503455, 11504288	25
19644	M8-1.25	1.70-5.50	1/16-7/32	28.5	1-1/8	Phosphate	10084751	15
25045	M8-1.25	3		27.3		Magni-565	11569971	5
18401	M8-1.25*	4.00-7.00	5/32-9/32	21	13/16	Magni-565	N801117-S10	25
11631	M10-1.50	1.00-6.00	3/64-15/64	19	3/4	Phosphate	11500662	25
18339	M10-1.50	1.50-5.50	1/16-7/32	28	1-3/32	Zinc Organic	11500663, N623344-S2	25
23784	M12-1.75	2.50-5.00	.098-.197	60	2.360	Black	N800325S2	10

*Locking Feature



Metric Flat Washers DIN 125



Auveco Part No.	Screw Size	Inner Diameter	Outer Diameter	Thickness	Finish	Unit Pkg.
10577	4mm	4.3mm	9mm	0.8mm	Zinc	50
10578	5mm	5.3mm	11mm	1mm	Zinc	50
10579	6mm	6.4mm	12mm	1.5mm	Zinc	50
17393	6mm	6.4mm	12mm	1.5mm	Zinc	100
10580	7mm	7.4mm	14mm	1.5mm	Zinc	50
10581	8mm	8.4mm	15.8mm	2mm	Zinc	25
16764▲	8mm	8.4mm	15.8mm	1.5mm	Yellow Zinc	100
10582	10mm	10.5mm	21mm	2mm	Zinc	25
17395	10mm	10.5mm	21mm	2mm	Zinc	100
10583	12mm	13mm	24mm	2.5mm	Zinc	25
14632	14mm	15mm	28mm	2.5mm	Zinc	50
14633	16mm	17mm	30mm	3mm	Zinc	50
14634	20mm	21mm	37mm	3mm	Zinc	50

▲WARNING: Reproductive Harm & Cancer
www.P65Warnings.ca.gov

(Continued on next page)



Metric Lock Washers DIN 127 Spring Steel • Zinc Plated

Auveco Part No.	Screw Size	I.D.	O.D.	Thick-ness	Unit Pkg.
10584	4mm	4.1mm	7.4mm	0.9mm	50
10585	5mm	5.1mm	9.0mm	1.2mm	50
10586	6mm	6.1mm	11.5mm	1.6mm	50
17396	6mm	6.1mm	11.5mm	1.6mm	100
10587	7mm	7.1mm	12.2mm	1.6mm	50
10588	8mm	8.2mm	14.4mm	2mm	50
17397	8mm	8.2mm	14.4mm	2mm	100
10589	10mm	10.2mm	17.5mm	2.2mm	50
17398	10mm	10.2mm	17.5mm	2.2mm	100
10590	12mm	12.2mm	20.3mm	2.5mm	25
14636	16mm	16.2mm	27.4mm	3.5mm	50



Metric Spring Washers DIN 137 Spring Steel • Zinc Plated

Auveco Part No.	Screw Size	I.D.	O.D.	Thick-ness	Unit Pkg.
10591	4mm	4.3mm	8mm	0.5mm	50
10592	5mm	5.3mm	10mm	0.5mm	50
10593	6mm	6.4mm	11mm	0.5mm	50
10595	8mm	8.4mm	15mm	0.8mm	50
10596	10mm	10.5mm	18mm	1.0mm	25



Metric Copper Washers DIN 7603



Auveco Part No.	Screw Size	Inner Diameter	Outer Diameter	Thickness	Unit Pkg.
14866	8mm	8.2mm	11.8mm	0.8mm	50
14867	10mm	10.2mm	15.8mm	0.8mm	50
14868	12mm	12.2mm	17.8mm	1.4mm	25
14869	14mm	14.2mm	17.8mm	1.4mm	25
14870	14mm	14.2mm	19.8mm	1.4mm	25
14871	16mm	16.2mm	19.8mm	1.4mm	25



Sealing Washers Copper

Auveco Part No.	Size ID x OD x Thickness	Unit Pkg.
23911	6 x 10 x 1.0mm	100
23912	6 x 12 x 1.0mm	100
23913	8 x 12 x 1.0mm	100
23914	10 x 14 x 1.0mm	100
23915	10 x 16 x 1.0mm	100
23916	12 x 16 x 1.5mm	50
23917	12 x 18 x 1.5mm	50
23918	14 x 18 x 1.5mm	50
23919	18 x 22 x 1.5mm	50
23920	18 x 24 x 1.5mm	25
23910	20 x 24 x 1.5mm	25
23921	20 x 26 x 1.5mm	25
23924	10 x 14 x 1.0mm	100



Sealing Washers Aluminum

Auveco Part No	Size ID x OD x Thickness	Unit Pkg.
23925	12 x 16 x 1.5mm	100
23926	12 x 18 x 1.5mm	100
23927	14 x 18 x 1.5mm	100
23442	14 x 20 x 1.5mm	100
23960	14 x 22 x 1.5mm	100
24128	14 x 24 x 1.5mm	25
23928	16 x 22 x 1.5mm	100
23929	20 x 24 x 1.5mm	100
23930	20 x 26 x 1.5mm	50
23931	22 x 27 x 1.5mm	50

METRIC ITEMS

For Actual Size Illustrations, Refer to Pages 159 - 160



Retaining Rings - Basic Internal DIN 472 - 1300

Groove required in Bore
Phosphate & Oil Finish



Auveco Part No.	Shaft Diameter		Groove Diameter		Groove Width		Unit Pkg.
	mm	Inches	mm	Inches	mm	Inches	
11488	30	1.181	31.4	1.237	1.30	.051	50
11491	40	1.575	42.5	1.675	1.85	.073	25
11494	52	2.047	55.0	2.165	2.15	.085	25
11495	62	2.441	65.0	2.559	2.15	.085	10



Retaining Rings - Basic External DIN 471 - 1400

Groove required on Shaft
Phosphate & Oil Finish



Auveco Part No.	Shaft Diameter		Groove Diameter		Groove Width		Unit Pkg.
	mm	Inches	mm	Inches	mm	Inches	
11500	10.0	.394	9.6	.378	1.10	.043	100
11503	17.0	.670	16.2	.637	1.10	.043	50
11505	25.0	.985	23.9	.941	1.30	.051	50
11506	30.0	1.182	28.6	1.126	1.60	.063	50
11507	35.0	1.378	33.0	1.299	1.60	.063	50



Retaining Rings - E Type DIN 6799 - 1500













Phosphate & Oil Finish



Auveco Part No.	Shaft Diameter		Groove Diameter		Groove Width		Unit Pkg.
	mm	Inches	mm	Inches	mm	Inches	
11514	2.0	.079	1.5	.059	0.44	.0173	100
11515	2.5	.098	1.9	.075	0.54	.0213	100
11516	3.0	.118	2.3	.091	0.64	.0252	100
11517	4.0	.157	3.2	.126	0.64	.0252	100
11518	5.0	.197	4.0	.157	0.74	.0291	100
11519	6.0	.236	5.0	.197	0.74	.0291	100
11520	7.0	.276	6.0	.236	0.74	.0291	100
11521	8.0	.315	7.0	.276	0.94	.0370	100
11523	10.0	.394	9.0	.354	1.15	.0453	100
11527	20.0	.787	19.0	.748	1.78	.0700	50

METRIC GREASE FITTINGS

(Available in Large Bulk Quantities)

 <p>11097 15122 15123 15426</p>	<p>6mm-1.00, Straight DIN 71412 (VW: N185151) Overall Length: 14mm Ball Check, Plated Ref No. 8601</p> <p>Unit Package: 5 Unit Package: 50 Unit Package: 100 Unit Package: 1000</p>	 <p>11779 15140 15141</p> <p>8mm-1.25, 45° Overall Length: 23mm Ball Check, Plated Ref No. 7545</p> <p>Unit Package: 10 Unit Package: 50 Unit Package: 100</p>
 <p>11098 15124 15125</p>	<p>8mm-1.00, Straight DIN 71412 (VW: N185161) Overall Length: 15mm Ball Check, Plated Ref No. 8901</p> <p>Unit Package: 5 Unit Package: 50 Unit Package: 100</p>	 <p>15067 15098</p> <p>10mm-1.00, 45° Overall Length: 23mm Ball Check, Plated Ref No. 9345</p> <p>Unit Package: 25 Unit Package: 100</p>
 <p>11778 15138 15139 15434</p>	<p>8mm-1.25, Straight Overall Length: 15mm Ball Check, Plated Ref No. 9201</p> <p>Unit Package: 10 Unit Package: 50 Unit Package: 100 Unit Package: 1000</p>	 <p>11776 15134 15135</p> <p>6mm-1.00, 90° Overall Length: 18mm Ball Check, Plated Ref No. 7090</p> <p>Unit Package: 10 Unit Package: 50 Unit Package: 100</p>
 <p>11100 15128 15129</p>	<p>10mm-1.00, Straight DIN 71412 (VW: N185301) Overall Length: 15mm Ball Check, Plated Ref No. 9301</p> <p>Unit Package: 5 Unit Package: 50 Unit Package: 100</p>	 <p>11099 15126 15127</p> <p>8mm-1.00, 90° DIN 71412 (VW: N18 511 2) Overall Length: 18mm Ball Check, Plated Ref No. 7940</p> <p>Unit Package: 5 Unit Package: 50 Unit Package: 100</p>
 <p>17555</p>	<p>10mm-1.5 Straight Overall Length: 15mm Ball Check Ref No. 9501</p> <p>Unit Package: 50</p>	 <p>11780 15142 15143</p> <p>8mm-1.25, 90° Overall Length: 18mm Ball Check, Plated Ref No. 7590</p> <p>Unit Package: 10 Unit Package: 50 Unit Package: 100</p>
 <p>11775 15132 15133</p>	<p>6mm-1.00, 45° Overall Length: 22mm Ball Check, Plated Ref No 7045</p> <p>Unit Package: 10 Unit Package: 50 Unit Package: 100</p>	 <p>11101 15130 15131</p> <p>10mm-1.00, 90° DIN 71412 (VW: N18 510 1) Overall Length: 19mm Ball Check, Plated Ref No. 9390</p> <p>Unit Package: 5 Unit Package: 50 Unit Package: 100</p>
 <p>11777 15136 15137</p>	<p>8mm-1.00, 45° Overall Length: 23mm Ball Check, Plated Ref No. 7445</p> <p>Unit Package: 10 Unit Package: 50 Unit Package: 100</p>	

 **WARNING:** ALL ITEMS ON PAGE Reproductive Risk & Cancer www.P65Warnings.ca.gov



Concave Type



Cup Type

Metric Expansion Plugs Zinc Plated

Auveco Part No.	Size	Type	Unit Pkg.
11876	18.0mm	Cup	25
11877	20.0mm	Cup	25
11878	22.0mm	Cup	25
11879	25.0mm	Cup	25
11881	30.0mm	Cup	25
11884	35.0mm	Cup	10
11886	38.0mm	Cup	10
11888	40.3mm	Cup	10
11896	50.0mm	Cup	10

Metric Cotter Pins ASME B18.8.6M • Steel



Auveco Part No.	Diameter	Length	Unit Pkg.
10553	2mm	18mm	100
10556	2.5mm	25mm	100
10557	3.2mm	20mm	100
24123	3.2mm	32mm	100
24124	3.2mm	40mm	100
10558	3mm	25mm	100
10559	3mm	30mm	100
10560	3mm	35mm	50
10564	4mm	40mm	50
10566	5mm	35mm	25
10567	5mm	40mm	25
10568	5mm	45mm	25

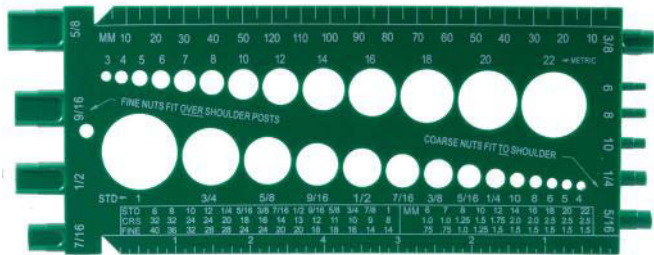

21152

U.S.S., S.A.E. & Metric Bolt and Nut Gauge.

Excellent for sizing bolts, screws, nuts (USS, SAE, and Metric) and twist drills. Determine the bolt diameter by pushing the bolt through the sizing holes, as well as, gauges hex nuts and washers (USS & SAE) size. Metric hex nuts and washers can be measured by holding them under the metric holes.

The back of the gauge includes a feature for measuring U.S. and Metric thread pitch. Special notches on the front of the tool allow you to measure flat head metal and wood screws.

Made of sturdy, light weight green plastic that resists water, alcohol, oil and grease.

UNIT PACKAGE: 1

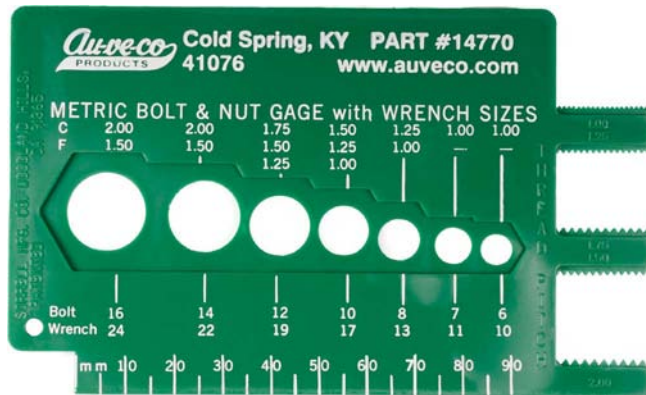

14770

Metric Bolt & Nut Gauge

Determine the diameter of the bolts by pushing them through the holes. Measure the hex head of bolts and screws or the "across the flat" dimension of hex nuts in the recesses around the holes (listed as wrench size).

Right-hand side of tool measures thread pitch (1.00, 1.50, 1.75 & 2.00)

UNIT PACKAGE: 1

Thread Pitches

Approximate threads per inch for Metric Screws, Bolts and Nuts

Diameter in mm	3	4	5	6	7	8	10	12	14	16
Diameter in Inch	.118	.157	.197	.236	.276	.315	.394	.472	.551	.630
Standard Pitch mm	.5	.7	.8	1.0	1.0	1.25	1.5	1.75	2.0	2.0
Approx. Threads/Inch	51	36	32	25	25	20	17	14	12	12
Fine Pitch mm						1.0	1.25	1.5	1.5	1.5
Approx. Threads/Inch						25	20	17	17	17
Extra Fine Pitch mm							1.0	1.25	1.25	1.25
Approx. Threads/Inch							25	20	20	20

Inch Fractions and Decimals to Metric Equivalents

Inches			Inches			Inches		
Fractions	Decimals	mm	Fractions	Decimals	mm	Fractions	Decimals	mm
----	.0004	.01	31/64	.48437	12.303	----	1.1417	29
----	.004	.10	----	.492	12.5	1-5/32	1.156	29.369
----	.01	.25	1/2	.500	12.700	----	1.1811	30
1/64	.0156	.397	----	.5118	13	1-3/16	1.1875	30.163
----	.0197	.50	33/64	.5156	13.097	1-7/32	1.219	30.956
----	.0295	.75	17/32	.53125	13.494	----	1.2205	31
1/32	.03125	.794	35/64	.54687	13.891	1-1/4	1.250	31.750
----	.0394	1	----	.5512	14	----	1.2598	32
3/64	.0469	1.191	9/16	.5625	14.288	1-9/32	1.281	32.544
----	.059	1.5	----	.571	14.5	----	1.2992	33
1/16	.0625	1.588	37/64	.57812	14.684	1-5/16	1.312	33.338
5/64	.0781	1.984	----	.5906	15	----	1.3386	34
----	.0787	2	19/32	.59375	15.081	1-11/32	1.344	34.131
3/32	.094	2.381	39/64	.60937	15.478	1-3/8	1.375	34.925
----	.0984	2.5	5/8	.6250	15.875	----	1.3779	35
7/64	.1093	2.776	----	.6299	16	1-13/32	1.406	35.719
----	.1181	3	41/64	.6406	16.272	----	1.4173	36
1/8	.1250	3.175	----	.6496	16.5	1-7/16	1.438	36.513
----	.1378	3.5	21/32	.65625	16.669	----	1.4567	37
9/64	.1406	3.572	----	.6693	17	1-15/32	1.469	37.306
5/32	.15625	3.969	43/64	.67187	17.066	----	1.4961	38
----	.1575	4	11/16	.6875	17.463	1-1/2	1.500	38.100
11/64	.17187	4.366	45/64	.7031	17.859	1-17/32	1.531	38.894
----	.177	4.5	----	.7087	18	----	1.5354	39
3/16	.1875	4.763	23/32	.71875	18.256	1-9/16	1.562	39.688
----	.1969	5	----	.7283	18.5	----	1.5748	40
13/64	.2031	5.159	47/64	.73437	18.653	1-19/32	1.594	40.481
----	.2165	5.5	----	.7480	19	----	1.6142	41
7/32	.21875	5.556	3/4	.7500	19.050	1-5/8	1.625	41.275
15/64	.23437	5.953	49/64	.7656	19.447	----	1.6535	42
----	.2362	6	25/32	.78125	19.844	1-21/32	1.6562	42.069
1/4	.2500	6.350	----	.7874	20	1-11/16	1.6875	42.863
----	.2559	6.5	51/64	.79687	20.241	----	1.6929	43
17/64	.2656	6.747	13/16	.8125	20.638	1-21/32	1.719	43.656
----	.2756	7	----	.8268	21	----	1.7323	44
9/32	.28125	7.144	53/64	.8281	21.034	1-3/4	1.750	44.450
----	.2953	7.5	27/32	.84375	21.431	----	1.7717	45
19/64	.29687	7.541	55/64	.85937	21.828	1-25/32	1.781	45.244
5/16	.3125	7.938	----	.8662	22	----	1.8110	46
----	.3150	8	7/8	.8750	22.225	1-13/16	1.8125	46.038
21/64	.3281	8.334	57/64	.8906	22.622	1-27/32	1.844	46.831
----	.335	8.5	----	.9055	23	----	1.8504	47
11/32	.34375	8.731	29/32	.90625	23.019	1-7/8	1.875	47.625
----	.3543	9	59/64	.92187	23.416	----	1.8898	48
23/64	.35937	9.128	15/16	.9375	23.813	1-29/32	1.9062	48.419
----	.374	9.5	----	.9449	24	----	1.9291	49
3/8	.3750	9.525	61/64	.9531	24.209	1-15/16	1.9375	49.213
25/64	.3906	9.922	31/32	.96875	24.606	----	1.9685	50
----	.3937	10	----	.9843	25	1-31/32	1.969	50.006
13/32	.4062	10.319	1	1.000	25.4	2	2.000	50.800
----	.413	10.5	----	1.0236	26	----	2.0079	51
27/64	.42187	10.716	1-1/32	1.0312	26.194	----	2.0472	52
----	.4331	11	1-1/16	1.062	26.988	2-1/16	2.062	52.388
7/16	.4375	11.113	----	1.063	27	----	2.0866	53
29/64	.4531	11.509	1-3/32	1.094	27.781	2-1/8	2.125	53.975
15/32	.46875	11.906	----	1.1024	28	----	2.126	54
----	.4724	12	1-1/8	1.125	28.575	----	2.165	55

Inch Fractions and Decimals to Metric Equivalents

Inches			Inches			Inches		
Fractions	Decimals	mm	Fractions	Decimals	mm	Fractions	Decimals	mm
2-3/16	2.1875	55.563	----	3.1496	80	4-1/4	4.250	107.950
----	2.2047	56	3-3/16	3.1875	80.963	4-5/16	4.312	109.538
----	2.244	57	----	3.1890	81	----	4.3307	110
2-1/4	2.250	57.150	----	3.2283	82	4-3/8	4.375	111.125
----	2.2835	58	3-1/4	3.250	82.550	4-7/16	4.438	112.713
2/5-16	2.312	58.738	----	3.2677	83	4-1/2	4.500	114.300
----	2.3228	59	----	3.3071	84	----	4.5275	115
----	2.3622	60	3-5/16	3.312	84.1377	4-9/16	4.562	115.888
2-3/8	2.375	60.325	----	3.3464	85	4-5/8	4.625	117.475
----	2.4016	61	3-3/8	3.375	85.725	----	4.7244	120
2-7/16	2.438	61.913	----	3.3858	86	4-3/4	4.750	120.650
----	2.4409	62	----	3.4252	87	4-7/8	4.875	123.825
----	2.4803	63	3-7/16	3.438	87.313	----	4.9212	125
2-1/2	2.500	63.500	----	3.4646	88	5	5.000	127
----	2.5197	64	3-1/2	3.500	88.900	----	5.1181	130
----	2.559	65	----	3.5039	89	5-1/4	5.250	133.350
2-9/16	2.562	65.088	----	3.5433	90	5-1/2	5.500	139.700
----	2.5984	66	3-9/16	3.562	90.4877	----	5.5118	140
2-5/8	2.625	66.675	----	3.5827	91	5-3/4	5.750	146.050
----	2.638	67	----	3.622	92	----	5.9055	150
----	2.6772	68	3-5/8	3.625	92.075	6	6.00	152.400
2-11/16	2.6875	68.263	----	3.6614	93	6-1/4	6.250	158.750
----	2.7165	69	3-11/16	3.6875	93.663	----	6.2992	160
2-3/4	2.750	69.850	----	3.7008	94	6-1/2	6.500	165.100
----	2.7559	70	----	3.7401	95	----	6.6929	170
----	2.7953	71	3-3/4	3.750	95.250	6-3/4	6.750	171.450
2-13/16	2.8125	71.438	----	3.7795	96	7	7.000	177.800
----	2.8346	72	3-13/16	3.8125	96.838	----	7.0866	180
----	2.8740	73	----	3.8189	97	----	7.4803	190
2-7/8	2.875	73.025	----	3.8583	98	7-1/2	7.500	190.500
----	2.9134	74	3-7/8	3.875	98.425	----	7.8740	200
2-15/16	2.9375	74.613	----	3.8976	99	8	8.000	203.200
----	2.9527	75	----	3.9370	100	----	8.2677	210
----	2.9921	76	3-15/16	3.9375	100.013	8-1/2	8.500	215.900
3	3.000	76.200	----	3.9764	101	----	8.6614	220
----	3.0315	77	4	4.000	101.600	9	9.000	228.600
3-1/16	3.062	77.788	4-1/16	4.062	103.188	----	9.0551	230
----	3.0709	78	4-1/8	4.125	104.775	----	9.4488	240
----	3.1102	79	----	4.1338	105	9-1/2	9.500	241.300
3-1/8	3.125	79.375	4-3/16	4.1875	106.363	----	9.8425	250

U.S. STANDARD GAUGE CHART

Gauge	Decimal Size	Gauge	Decimal Size	Gauge	Decimal Size	Gauge	Decimal Size
7	.188"	14	.078"	21	.034"	28	.016"
8	.172"	15	.070"	22	.031"	29	.014"
9	.156"	16	.063"	23	.028"	30	.013"
10	.141"	17	.056"	24	.025"	31	.011"
11	.125"	18	.050"	25	.022"		
12	.109"	19	.044"	26	.019"		
13	.094"	20	.038"	27	.017"		

Prevailing Torque Lock Nuts

Grade 8 • Cad and Waxed

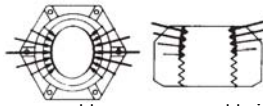

Auveco Part No.	Thread Size	Hex Width	Unit Pkg.
12697	1/4"-20 USS	7/16"	50
12698	5/16"-18 USS	1/2"	50
12699	3/8"-16 USS	9/16"	50
12707	3/8"-24 SAE	9/16"	50
12700	7/16"-14 USS	11/16"	50
12708	7/16"-20 SAE	11/16"	50
12701	1/2"-13 USS	3/4"	25
12710	9/16"-18 SAE	7/8"	25
12703	5/8"-11 USS	15/16"	10
12711	5/8"-18 SAE	15/16"	10
12704	3/4"-10 USS	1-1/8"	10

WARNING: ALL ITEMS IN CHART Reproductive Harm
www.P65Warnings.ca.gov



Hexagon Machine Screw Nuts

Zinc Plated Steel

Auveco Part No.	Thread Size	Hex Width	Unit Pkg.
727	6-32	5/16"	100
728	8-32	11/32"	100
729	10-32	3/8"	100
730	10-24	3/8"	100
731	12-24	7/16"	100
733	1/4"-20	7/16"	100



Reversible Lock Nuts

Grade 2 • Zinc Plated

Auveco Part No.	Thread Size	Hex Width	Unit Pkg.
11740	1/4"-20	7/16"	100
11741	5/16"-18	1/2"	100
11742	3/8"-16	9/16"	50
24126	3/8"-24	9/16"	50
24531	7/16"-14	25"	



Hexagon Machine Screw Nuts

Double Chamfered • Plain Brass

Auveco Part No.	Thread Size	Hex Width	Unit Pkg.
3868	10-24 USS	3/8"	100
24115	1/2"-20	1/2"	50

WARNING: Reproductive Harm
www.P65Warnings.ca.gov



Slotted Hex Nuts

Zinc Finish

Auveco Part No.	Thread Size	Hex Width	Slot Width	Unit Pkg.
12723	5/8"-18	15/16"	3/16"-15/64"	25



Nylon Insert Lock Nuts

Grade 2 • Zinc Plated

Auveco Part No.	Thread Size	Hex Width	Unit Pkg.
9535	8-32	11/32"	100
9536	10-24 USS	3/8"	100
9537	10-32 SAE	3/8"	100
9538	12-24	7/16"	100
9539	1/4"-20 USS	7/16"	100
9540	1/4"-28 SAE	7/16"	100
9541	5/16"-18 USS	1/2"	50
9542	5/16"-24 SAE	1/2"	50
9543	3/8"-16 USS	9/16"	50
9544	3/8"-24 SAE	9/16"	50
9545	7/16"-14 USS	5/8"	50
9546	7/16"-20 SAE	5/8"	50
9547	1/2"-13 USS	3/4"	50
9548	1/2"-20 SAE	3/4"	50
15863	5/8"-11 USS	15/16"	25
15864	5/8"-18 SAE	15/16"	25
15865	3/4"-10 USS	1-1/8"	25



LockOne

Fast & easy to install-no special tools required
 Corrosion resistant, 304 Stainless Steel
 Reusable, does not degrade with each cycle
 Vibration-Proof, positive locking force
 Designed for harsh environments
 Ideal for weight sensitive applications

U.S.S. (Coarse)

Auveco Part No.	Thread Size	Hex	Thickness	Wire Width	Weight	Unit Pkg.
22866	1/4-20	0.43	0.11	0.03	0.80 g	10
22868	3/8-16	0.55	0.13	0.04	1.30 g	10
22869	1/2-13	0.75	0.16	0.05	3.00 g	10

Sec. 08



Finished USS (Coarse) & SAE (Fine) Hexagon Nuts Grade 2 • Zinc Plated

Auveco Part No.	Thread Size	Hex Width	Unit Pkg.
3541	1/4"-20 USS	7/16"	100
3542	1/4"-28 SAE	7/16"	100
3543	5/16"-18 USS	1/2"	100
3544	5/16"-24 SAE	1/2"	100
3545	3/8"-16 USS	9/16"	100
3546	3/8"-24 SAE	9/16"	100
3547	7/16"-14 USS	11/16"	100
3548	7/16"-20 SAE	11/16"	100
3549	1/2"-13 USS	3/4"	100
3550	1/2"-20 SAE	3/4"	100
8659	9/16"-12 USS	7/8"	50
8660	9/16"-18 SAE	7/8"	50
8661	5/8"-11 USS	15/16"	50
8663	3/4"-10 USS	1-1/8"	50



Finished USS (Coarse) & SAE (Fine) Hex Nuts Grade 5 • Zinc Plated

Fully Certified for S.A.E. J995 Standard
Proof Load: 120,000 PSI
C32 Max. Rockwell Hardness

Auveco Part No.	Thread Size	Hex Width	Unit Pkg.
15586	1/4"-20 USS	7/16"	100
15587	5/16"-18 USS	1/2"	100
15588	3/8"-16 USS	9/16"	100
15589	7/16"-14 USS	11/16"	50
15590	1/2"-13 USS	3/4"	50
16981	9/16"-12 USS	7/8"	25
15591	5/8"-11 USS	15/16"	25
15592	3/4"-10 USS	1-1/8"	25



Finished USS (Coarse) & SAE (Fine) Hexagon Nuts Grade 8 • Yellow Zinc Plated High Alloy

Auveco Part No.	Thread Size	Hex Width	Unit Pkg.
9300	1/4"-20 USS	7/16"	100
9307	1/4"-28 SAE	7/16"	100
9301	5/16"-18 USS	1/2"	100
9308	5/16"-24 SAE	1/2"	100
9302	3/8"-16 USS	9/16"	100
9309	3/8"-24 SAE	9/16"	100
9303	7/16"-14 USS	11/16"	50
9310	7/16"-20 SAE	11/16"	50
9304	1/2"-13 USS	3/4"	50
9311	1/2"-20 SAE	3/4"	50
9305	5/8"-11 USS	15/16"	25
9312	5/8"-18 SAE	15/16"	25
9306	3/4"-10 USS	1-1/8"	25

WARNING: ALL ITEMS IN CHART Reproductive Harm & Cancer
www.P65Warnings.ca.gov

NUTS



Finished USS (Coarse) & SAE (Fine) Hex Nuts

Grade 8 • Yellow Zinc Plated
Fully Certified for S.A.E. J995 Standard
Proof Load: 150,000 PSI

C24-C32 Max. Rockwell Hardness for 1/4 thru 5/8
C26-C34 Max. Rockwell Hardness for 3/4 thru 1

Auveco Part No.	Thread Size	Hex Width	Unit Pkg.
15640	1/4"-20 USS	7/16"	100
15649	1/4"-28 SAE	7/16"	100
15641	5/16"-18 USS	1/2"	100
15650	5/16"-24 SAE	1/2"	100
15642	3/8"-16 USS	9/16"	100
15651	3/8"-24 SAE	9/16"	100
15643	7/16"-14 USS	11/16"	50
15652	7/16"-20 SAE	11/16"	50
15644	1/2"-13 USS	3/4"	50
15653	1/2"-20 SAE	3/4"	50
16983	9/16"-12 USS	7/8"	25
15645	5/8"-11 USS	15/16"	25
15654	5/8"-18 SAE	15/16"	25
15646	3/4"-10 USS	1-1/8"	15

WARNING: ALL ITEMS IN CHART Reproductive Harm & Cancer
www.P65Warnings.ca.gov



Keps® Lock Washer & Nut Zinc Plated

Auveco Part No.	Thread Size	Hex Width	Unit Pkg.
3492	6-32	5/16"	100
3493	8-32	11/32"	100
3494	10-24	3/8"	100
3495	10-32	3/8"	100
3496	1/4"-20	7/16"	100
3497	1/4"-28	7/16"	100
3498	5/16"-18	1/2"	100
3499	5/16"-24	1/2"	100
3500	3/8"-16	9/16"	100



Square Nuts

Auveco Part No.	Thread Size	Width	Finish	Unit Pkg.
3250	1/4"-20	7/16"	Bright Zinc	100



Cage Nuts Phosphate Plated

Auveco Part No.	Thread Size	Fits Sq. Hole	Panel Range	Unit Pkg.
24013	#10-32	.343-.380"	.25-.63"	50
3144	1/4"-20	3/8"	.064-.105"	50
10773	1/4"-20	3/8"	.064-.105"	25
3798	5/16"-18	1/2"	.023-.063"	50
24056	3/8"-16	.46-.508"	.93-.126"	50



Spin Lock Nuts with Serrations

Auveco Part No.	Thread Size	Flange O.D.	Hex Width	Unit Pkg.
Standard Flange - Zinc Plated				
14878	8-32	15/32"	11/32"	100
14873	10-24	USS 1/2"	3/8"	100
14874	1/4"-20	USS 19/32"	7/16"	100
14875	5/16"-18	USS 11/16"	1/2"	100
14876	3/8"-16	USS 3/4"	9/16"	100
14877	7/16"-14	USS 15/16"	11/16"	50
17084	1/2"-13	USS 1"	3/4"	25
24438	1/4"-20	USS 37/64"		100
24439	5/16"-18	USS 21/32"		100

Auveco Part No.	Thread Size	Flange O.D.	Hex Width	Unit Pkg.
Flange - Black Phosphate				
24052	8-32	USS 15/32"	11/32"	100
24053	10-32	USS 1/2"	3/8"	100
24007	1/4"-20	USS 19/32"	7/16"	100
24008	5/16"-18	USS 11/16"	1/2"	100
24009	5/16"-24	USS 11/16"	1/2"	100
24011	3/8"-24	USS 3/4"	9/16"	50
24180	7/16"-14	USS 15/16"	11/16"	50
24054	1/2"-13	USS 1-1/32"	3/4"	50
24055	1/2"-20	USS 1-1/32"	3/4"	50

Auveco Part No.	Thread Size	Flange O.D.	Hex Width	Unit Pkg.
Large Flange - Black Phosphate				
24436	#10-24	USS 31/64"		100
2769	1/4"-20	USS 11/16"	7/16"	100
5167	5/16"-18	USS 13/16"	1/2"	100
5596	3/8"-16	USS 7/8"	9/16"	100

Auveco Part No.	Thread Size	Flange O.D.	Hex Width	Unit Pkg.
Large Flange - Zinc				
24167	1/4"-20	23/32"	7/16"	100
24164	5/16"-18	13/16"	1/2"	100
24116	3/8"-16	7/8"	9/16"	50



Washer Base Wing Nuts Zinc Alloy

Auveco Part No.	Thread Size	Wing Spread	Overall Height	Washer O.D.	Unit Pkg.
10036	1/4"-20	1"	1/2"	3/4"	50



Wing Nuts Nickel Plated

Auveco Part No.	Size	Unit Pkg.
3741	1/4"-20	100
24006	5/16"-18	100
3743	3/8"-16	50

WARNING: Cancer
www.P65Warnings.ca.gov



Self-Locking Wing Nuts Bright Zinc Chromate

Auveco Part No.	Size	Unit Pkg.
9846	1/4"-20	100

WARNING: ALL ITEMS IN CHART Reproductive Harm & Cancer
www.P65Warnings.ca.gov



Air Cleaner Thumb Screw (Ford: 383132S9; 382461S9)

Auveco Part No.	Size	Unit Pkg.
23713	1/4"-20	25



Pushnut Bolt Retainers For Threaded Fasteners



Auveco Part No.	Bolt Dia.	O.D.	Finish	Unit Pkg.
16851	9/64" (#6)	11/32"	Zinc	100
10085	5/32" (#8)	3/8"	Phos.	100
16852	3/16" (#10)	7/16"	Phos.	100
10086	1/4"	1/2"	Zinc	100
22797	1/4"	1/2"	Phos.	100
10087	5/16"	5/8"	Zinc	100
22798	5/16"	5/8"	Phos.	100
9297	3/8"	25/32"	Zinc	100
22799	3/8"	25/32"	Phos.	100
9298	7/16"	27/32"	Zinc	100
22802	7/16"	27/32"	Phos.	100
22800	1/2"	15/16"	Phos.	100
9299	1/2"	15/16"	Zinc	100



Washer Lock Nuts Zinc Plated



Auveco Part No.	Thread Size	Hex Width	O.D.	Unit Pkg.
2554	6-32	5/16"	7/16"	100
2555	8-32	11/32"	15/32"	100
2556	10-32	3/8"	1/2"	100
2557	10-24	3/8"	1/2"	100
24165	#10-24	3/8"	5/8"	100
2558	10-24	3/8"	3/4"	100
2560	12-24	3/8"	3/4"	100
2561	1/4"-20	7/16"	19/32"	100
2562	1/4"-20	7/16"	13/16"	100
10764	5/16"-18	1/2"	13/16"	100

For an assortment of Washer Lock Nuts, see Fix-Kit 6043

Sec. 08



Flat Push-On Retainers For Non-Threaded Fasteners



Auveco Part No.	Stud Size	O.D.	Plating	Unit Pkg.
8861	1/16"	3/16"	Phos	100
8862	3/32"	3/16"	Phos	100
8863	1/8"	3/8"	Zinc	100
8864	5/32"	7/16"	Zinc	100
8865	3/16"	7/16"	Zinc	100
8867	.240"	17/32"	Zinc	100
8868	1/4"	17/32"	Zinc	100
8869	5/16"	5/8"	Zinc	100
10374	3/8"	3/4"	Zinc	100
10375	1/2"	1"	Zinc	100
24080	1/2"	1"	Phos	100
21080	5/8"	1"	Zinc	100



Push Nuts for Non-Threaded Fasteners

Auveco Part No.	Stud Size	Outer Diameter	Finish	Unit Pkg.
23878	1/4"	15/16"	Zinc	50
23879	5/16"	15/16"	Zinc	50
23880	3/8"	15/16"	Zinc	50
23882	1/2"	15/16"	Black	50



Hex Pal Nuts Plated



Auveco Part No.	Thread Size	Hex Width	Unit Pkg.
3975	3/8"-24	9/16"	100
8858	1/2"-20	3/4"	100

NUTS



Pal Nuts Zinc Finish

Auveco Part No.	Screw Size	Outer Diameter	Overall Height	Unit Pkg.
23669	#8-18	0.422"	0.220"	100



Acorn Cap Nuts Nickel Plated

Auveco Part No.	Thread Size	Hex Width	Height	Unit Pkg.
11179	8-32	5/16"	9/32"	100
11181	10-32	3/8"	11/32"	100
11182	1/4"-20	7/16"	3/8"	50
11183	5/16"-18	9/16"	7/16"	50
11184	3/8"-16	5/8"	1/2"	25

WARNING: ALL ITEMS IN CHART Cancer
www.P65Warnings.ca.gov

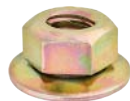

Free Spinning Washer Nuts



Auveco Part No.	Thread Size	Washer O.D.	Hex Size	Height	Plating	O.E.M. No.	Unit Pkg.
16770	#10-24	3/8"	5/16"	11/64"	Yellow Zinc	383255-S36	100
15345	1/4"-20	5/8"	7/16"	9/32"	Yellow Zinc	3866846, 385400	50
15347	1/4"-20	7/8"	7/16"	5/16"	Phosphate	45334,6023204, 6025004	50
15350	5/16"-18	3/4"	1/2"	3/8"	Phosphate	6025007	50
15351	3/8"-16	7/8"	9/16"	7/16"	Phosphate	376785	25

For metric sizes of Free Spinning Washer Nuts, refer to page 109



3400

Zinc

Stud Size: 1/8"
Hex: 1/4"

UNIT PACKAGE: 200



3401

Zinc

Stud Size: 1/8"
Hex: 5/16"

UNIT PACKAGE: 200



2895

Zinc

Stud Size: 1/8"
Hex: 5/16"
Washer Diameter: 17/32"

UNIT PACKAGE: 100



2896

Zinc

Stud Size: 3/16"
Hex: 3/8"
Washer Diameter: 5/8"

UNIT PACKAGE: 100



2897

Zinc

Stud Size: 1/4"
Hex: 7/16"
Washer Diameter: 19/32"

UNIT PACKAGE: 100



3403

Zinc

Stud Size: 1/8"
Hex: 5/16"
Washer Diameter: 7/16"

UNIT PACKAGE: 200



3404

Zinc

Stud Size: 3/16"
Hex: 3/8"
Washer Diameter: 1/2"

UNIT PACKAGE: 200



8855

Zinc

Stud Size: 5/32"
Hex: 3/8"
Washer Diameter: 9/16"

UNIT PACKAGE: 100



3405

Zinc

Stud Size: 1/4"
Hex: 7/16"
Washer Diameter: 11/16"

UNIT PACKAGE: 200



23636

Steel

Finish: Zinc
Stud Size: 0.330"
Hex: 1/2"
Washer Diameter: 3/4"

UNIT PACKAGE: 100



10733

Zinc

Stud Size: 5/16"
Hex: 1/2"
Washer Diameter: 7/8"

UNIT PACKAGE: 100



Sec. 08

WHEEL STUDS, BOLTS AND NUTS

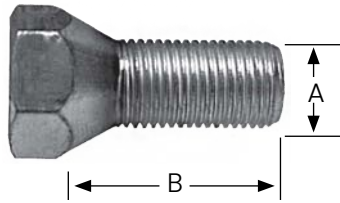

Type #1

Wheel Studs & Bolts
Grade 8 Steel • Plated
UNIT PACKAGE: 10

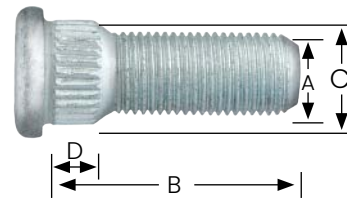

Type #2

Auveco Part No.	Type	Diameter (A)	Length (B)	Knurl Dia. (C)	Shoulder Length (D)	Application
14225	1	1/2"-20	1.070"/1.100"	N/A	N/A	Universal (3/4" Hex)
14227	2	1/2"-20	1.510"/1.540"	.618"/.628"	.310"/.330"	GM 76-55; Int. 80-67
14228	2	7/16"-20	1.380"/1.410"	.556"/.566"	.300"/.320"	GM 51-On
14231	2	1/2"-20	1.615"/1.635"	.618"/.628"	.440"/.460"	Ford 62-On
14235	2	1/2"-20	1.620"/1.650"	.618"/.628"	.630"/.650"	Dodge Tk 82-69; Ford 72-65; GMC 70-60
14237	2	1/2"-20	1.435"/1.465"	.556"/.566"	.420"/.440"	Ford 75-73
14241	2	7/16"-20	1.470"/1.500"	.460"/.470"	.333"/.343"	Chrysler 76-64; GM 84-62; Jeep 82-74
14244	2	1/2"-20	1.720"/1.750"	.615"/.625"	.445"/.460"	Ford 75-On

Wheel Nuts



Type 1 (Outer)



Type 5



Type 2 (Inner)



Type 4
(Stainless Steel Cap)



Type 6
(Stainless Steel Cap)

Auveco Part No.	Unit Pkg.	Type	Size	Height	Hex	O.E.M No.
8742	50	1	1/2"-20	9/16"	3/4"	Chry: 2409826
8744	50	1	1/2"-20	5/8"	13/16"	GM: 413945, 516637 Ford: C0AZ-1012A
8746	50	1	7/16"-20	9/16"	3/4"	Chry: 2072728
12520	5	2	3/4"-16 L.H. (Inner) 1-1/8"-16 L.H. (Outer)	2-7/32"	13/16" Sq.	Budd: 10709
12521	5	1	1-1/8"-16 L.H.	7/8"	1-1/2"	Budd: 37892
12522	5	2	3/4"-16 (Inner) R.H. 1-1/8"-16 (Outer) R.H.	2-7/32"	13/16" Sq.	Budd: 10708
12523	5	1	1-1/8"-16	7/8"	1-1/2"	Budd: 37891
12525	5	1	3/4"-16	7/8"	1-1/2"	Budd: 37888
12617	5	5	12mm-1.5	23mm	19mm	Chry: 6500092
12675	25	1	12mm-1.5	14mm	19mm	GM: 9590477
12695	5	4	12mm-1.5	34mm	19mm	GM: 10018202
12715	10	1	12mm-1.5	14mm	19mm	Chry: 6500526
14253	10	1	12mm-1.25	16mm	21mm	Nissan: 40224-21001
17353	5	6	12mm-1.5	30mm	19mm	Chry: 6502738

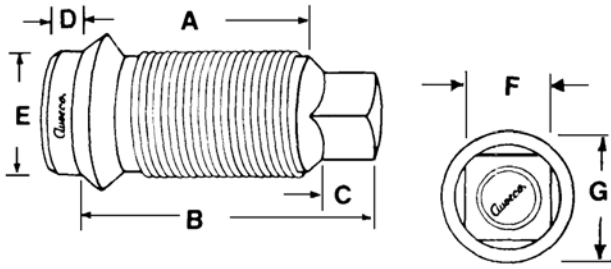

1-1/8" Inner Cap Nuts
3/4"-16 Inner Thread; 1-1/8"-16 Outer Thread
Zinc Plated

Auveco Thread			Dimensions							
Part No.	Type	Description	A	B	C	D	E	F	G	Pkg.
12520	LH	for Steel Wheels	1-7/16"	2-7/32"	17/32"		1-3/16"	13/16"	1-13/32"	5
12522	RH	for Steel Wheels	1-7/16"	2-7/32"	17/32"		1-3/16"	13/16"	1-13/32"	5
15010	LH	for Alum. Wheels; GR 8	1-21/32"	2-21/32"	5/8"	5/16"	1-1/8"	13/16"	1-13/32"	5

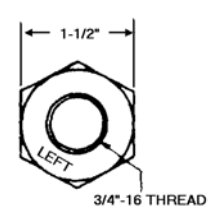
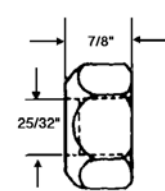
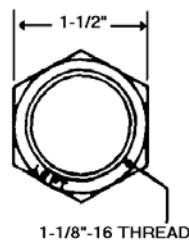
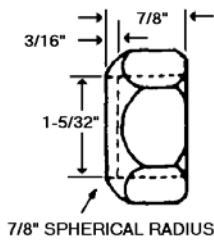

1-1/8" Outer Cap Nut
Zinc Plated

3/4" Outer Cap Nut
Single (3/4") Mounting Front & Rear
Zinc Plated

Auveco Part No.	Description	Unit Pkg.
12521	LH	5
12523	RH	5

Auveco Part No.	Description	Unit Pkg.
12525	RH	5



Flange Wheel Nuts



Rim Clamp Nuts
Zinc Plated

Auveco Part No.	Thread	Hex Size	Flange O.D.	Unit Pkg.
15011	5/8"-18(RH)	1-1/8"	1-5/8"	10

Auveco Part No.	Thread	Hex Size	Unit Pkg.
15015	3/4"-10	1-1/4"	25

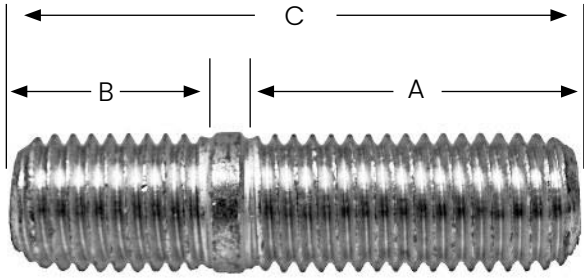

Rim Studs
Grade 8 • Zinc Plated

Auveco Part No.	A Dia. & Length	B Dia. & Length	C Overall Length	Unit Pkg.
15018	3/4"-10 USS x 1-7/8"	3/4"-10 USS x 1"	3-1/8"	25

Truck Wheel Hardware Interchange

The numbers listed in this interchange are cross referenced to the closest equivalent Auveco part. In some instances the parts are not identical, however the Auveco part is designed to service the same application

Part No.	Auveco Part No.	Part No.	Auveco Part No.	Part No.	Auveco Part No.
ALCOA		DAYTON WALTHER		NUTURN	
5988-L	15010	08-853501	12523	W-8	15015
		08-853502	12521	W-11	12522
		08-853701	12522	W-12	12520
		08-853702	12520	W-13	12523
				W-14	12521
				W-15	12525
				W-246	15018
				W-487	15010
BATCO		EUCLID			
13-3005-R	12522	4963	15015		
13-3012-L	12521	5549-L	12520		
13-3026-L	15010	5549-R	12522		
13-6005	15018	5552-L	12521		
13-8004	15015	5552-R	12523		
		5652-R	12525		
		5706	15018		
		5988-L	15010		
BUDD		GMC			
10708	12522	2201406	12522		
37888	12525	2201407	12520		
37891	12523	279670L	12521		
37892	12521	279670R	12523		
95188	15011				
DAYTON					
15016 5716	15015				
8411	15018				

Round Base: 3 Rivet or Nail Holes for Assembly

Material: Low Carbon Steel, Zinc Finish

For applications into materials of high density and where repeated bolt removal and replacement is expected.

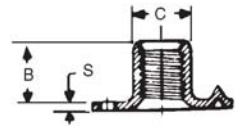
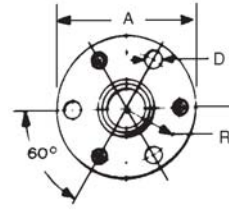

Auveco Part No.	Thread Size	A	B	C	D +.005	R	S	Unit Pkg.
2262	3/8"-16	1"	1/2"	.471/.466"	.145"	5/64"	.075"	100

Claw Prongs: Round Base

Material: Low Carbon Steel, Plain Finish

This Long Prong Teenut has six claw-like prongs that penetrate into wood, toe in, and grip so tightly that you have to drive it to back it out of its hole.

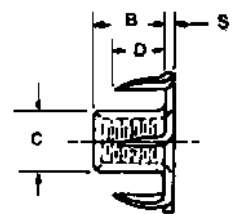
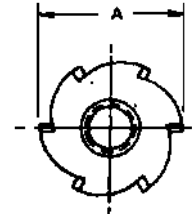

Auveco Part No.	Thread Size	A	B	C	D	S	Unit Pkg.
10729	10-24	3/4"	9/32"	.232/.227"	13/64"	.035"	50
11324	1/4"-20	3/4"	5/16"	.294/.289"	15/64"	.042"	50
10730	1/4"-20	3/4"	7/16"	.294/.289"	15/64"	.042"	50

Claw Prongs: Slimline, Round Base

Material: Low Carbon Steel, Plain Finish

Recommended where superior retention in soft wood is required.

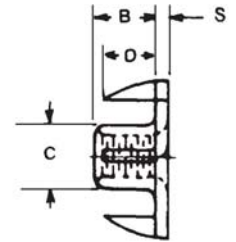
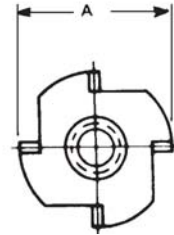

Auveco Part No.	Thread Size	A	B	C	D	S	Unit Pkg.
11325	1/4"-20	3/4"	5/16"	.294/.289"	15/64"	.042"	100
24120	1/4"-20	3/4"	7/16"	.305"	15/64"	0.47"	50
11326	5/16"-18	7/8"	3/8"	.369/.364"	19/64"	.052"	50
11327	3/8"-16	1.00"	7/16"	.448/.443"	11/32"	.062"	25

Straight Prongs: Round Base

Material: Low Carbon Steel, Plain Finish

This Teenut is recommended for thick material applications and applications requiring the top of the barrel to provide a bearing surface for mating parts.

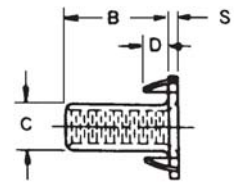
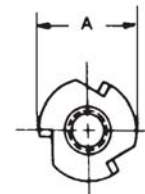

Auveco Part No.	Thread Size	A	B	C	D	Type	S	Unit Pkg.
11328	6-32	9/16"	15/64"	.164/.157"	1/8"	3 Prongs	.020"	50
11331	10-32	3/4"	9/32"	.232/.227"	13/64"	3 Prongs	.035"	50
11332	1/4"-20	3/4"	5/16"	.311/.306"	15/64"	4 Prongs	.050"	50

Threaded Inserts for Thin Material

The Auveco Thin Sheet Nutsert has been designed to provide a highly efficient method of securing threads from one side of the work, in materials generally too thin to support threads. Its performance has been proven in plastic, aluminum, mild steel and fiberglass. They can also withstand high loads without vibrating or loosening under extreme operating conditions. The Auveco Thin Sheet Nutsert is a tension fastener with high pull out, insuring no rotation or vibration where a cover plate is used. The system's unique blind tooling installs TSNs at consistent rates using unskilled labor.

How it Works

The Thin Sheet Nutsert, held securely by the tool, is placed into a prepared hole. Upon the tool's actuation, the threaded portion is pulled until the fastener's wall collapses radially outward, clinching it tight against the sheet. The tool is withdrawn, leaving the Thin Sheet Nutsert ready to receive a bolt or screw. This complete operation takes only a few seconds and can be performed by anyone.



Strength Tests: Torque Strength: with an attaching part over the Thin Sheet Nutsert, offering a bearing surface, the TSN will remain intact past the point of the screw or bolt breaking (head torqued off). In almost all cases the threads of the TSN will remain undistorted and serviceable; an exception to this statement is when an extremely high tensile bolt is used.

Steel: 1010 Low Carbon Steel, Type 11 Class 3 with Zinc Plate (Metric: Yellow Zinc Finish), Clear Chromate

Aluminum: Aluminum Alloy 5056, Plain Finish, Metric Class 6H, U.S. Class 2B

To set Nutserts, Use tool 11805 & Conversion Kits listed on Page 163.

U.S.S. & S.A.E.

Auveco Part No.	Unit Pkg.	Thread Size after Installation	Recommended Grip Range	A Max.	B Max.	D Ref.	Hole Size	Drill Size	
11310	13476	50	6-32 U.S.S.	.020-.080"	.249"	.410"	.287"	.250-.254"	1/4"
11315	13477	100							
11311		50	8-32 U.S.S.	.020-.080"	.249"	.410"	.287"	.250-.254"	1/4"
11316		100							
11312		50	10-24 U.S.S.	.020-.130"	.280"	.465"	.320"	.281-.285"	9/32"
11317		100							
12978		50	10-32 S.A.E.	.020-.130"	.280"	.465"	.320"	.281-.285"	9/32"
12979		100							
11313		25	1/4"-20 U.S.S.	.030-.165"	.347"	.610"	.415"	.375-.379"	3/8"
11318		100							
11314		25	5/16"-18 U.S.S.	.040-.200"	.499"	.720"	.540"	.500-.504"	1/2"
11319		100							
16785*		15	3/8"-16 U.S.S.	.040-.200"	.499"	.720"	.540"	.500-.504"	1/2"

*Cannot be set with Auveco tool 11805, requires pneumatic tool.

Regular Pitch Metric

Auveco Part No.	Unit Pkg.	Thread Size after Installation	Recommended Grip Range	A Max.	B Max.	D Ref.	Hole Size	Drill Size	
12980	50	M4-.7	.020-.080"	.249"	.410"	.287"	.250-.254"	1/4"	
		.508/2.030mm	6.32mm	10.41mm	7.29mm	6.35/6.45mm			
12981	100								
12982	50	M5-.8	.020-.130"	.280"	.465"	.320"	.281-.285"	9/32"	
		.508/3.300mm	7.11mm	11.81mm	8.13mm	7.14/7.24mm			
12983	100								
12984	13494	25	M6-1.0	.030-.165"	.374"	.610"	.415"	.375-.379"	3/8"
		.762/4.190mm	9.50mm	15.49mm	10.54mm	9.53/9.63mm			
	13495	100							
12986	25	M8-1.25	.040-.200"	.499"	.720"	.540"	.500-.504"	1/2"	
		1.020/5.080mm	12.67mm	18.29mm	13.72mm	12.71/12.80mm			
12987	100								

WARNING: ALL ITEMS ON PAGE Reproductive Risk & Cancer www.P65Warnings.ca.gov

LARGE FLANGE THIN SHEET NUTSERT® INSERTS

U.S.S., S.A.E. & Metric – Steel & Aluminum

Sec. 09

The Large Flange system provides captive threads in materials too thin to independently support threads, or where costly tapping operations are to be eliminated. The Large Flange fastener can be used as a rivet to join materials that will ultimately have a separate component attached.

Materials: Low Carbon Steel, Zinc Plated
(Metric: Zinc & Yellow Plated)
Aluminum Alloy, Plain Finish

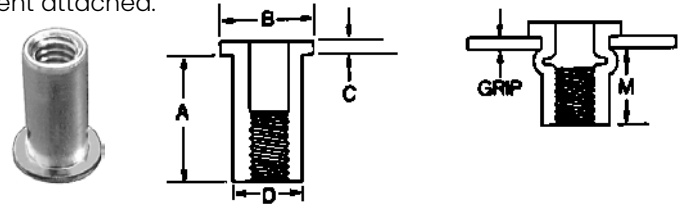

To Set 8-32, 10-24 and 10-32 Large Flange Nutserts, use tool 11805 and conversion kits listed on page 163.

Large Flange Nutserts, 1/4"-20, 5/16"-18 and 3/8"-16, require a pneumatic tool for installation. They cannot be set with 11805.

U.S.S. & S.A.E.

Auveco Part No.	Unit	Thread	Grip Range	Hole Size	A	B	C	D	M
Aluminum/Steel	Pkg.	Size			+ .015	+ .015	(NOM)	+ .000 - .004	(Ref.)
16177 16187	50	8-32 U.S.S.	.010-.075"	.221-.226"	.438"	.357"	.032"	.221"	.300"
16188	50	10-24 U.S.S.	.010-.080"	.250-.256"	.531"	.406"	.038"	.250"	.380"
16179 16189	50	10-24 U.S.S.	.080-.130"	.250-.256"	.594"	.406"	.038"	.250"	.390"
16180 16190	25	10-32 S.A.E.	.010-.080"	.250-.256"	.531"	.406"	.038"	.250"	.380"
16182* 16192*	25	1/4"-20 U.S.S.	.020-.080"	.332-.338"	.625"	.475"	.058"	.332"	.450"
16183* 16193*	25	1/4"-20 U.S.S.	.080-.140"	.332-.338"	.687"	.475"	.058"	.332"	.450"
16184* 16194*	25	5/16"-18 U.S.S.	.030-.125"	.413-.423"	.750"	.665"	.062"	.413"	.505"
16195*	25	5/16"-18 U.S.S.	.125-.200"	.413-.423"	.875"	.665"	.062"	.413"	.555"
16789*	10	3/8"-16 U.S.S.	.030-.115"	.490-.500"	.844"	.781"	.088"	.490"	.585"
16788*	10	3/8"-16 U.S.S.	.115-.200"	.490-.500"	.938"	.781"	.088"	.490"	.595"

*Cannot be set with Auveco tool 11805, requires pneumatic tool

Regular Pitch Metric

Auveco Part No.	Unit	Thread	Grip Range	Hole Size	A	B	C	D	M
Steel	Pkg.	Size			± .015	± .015	(NOM)	+ .000 - .004	(Ref.)
16978 ⚠	25	M6-1.0	.020-.118" .5-3.0mm	.358" 9.1mm	.630" 16mm	.510" 13mm	.059" 1.5mm	.356" 9mm	.450" 11.5mm

⚠ WARNING: Reproductive Harm & Cancer www.P65Warnings.ca.gov

STAY UP TO DATE WITH US

Auveco releases new items once a month.
Our New Items Bulletins can keep you up to date on all new product.

To receive these bulletins please contact customer service:
mail@auveco.com or 1-800-354-9816

We also have all previous and current bulletins posted on auveco.com.

The Auveco Nutsert was developed to offer both the production-oriented designer and the engineer a unique and versatile anchor nut-type insert for high-speed installation. This Auveco system gives the designer the option to design for **blind** or **open** applications, eliminating and simplifying their design problems.

Our system provides a cost-saving method of installing clean, load-bearing steel threads in castings, fiberglass, fiberboard, plastics, wood or almost any ductile material more than .030" thick.

A simple hand tool installs the Nutsert, it is ready for use in seconds and no finishing is required after installation.

Auveco Nutsert's advanced design offers unlimited grip range in a minimum of sizes. Inventory is minimized to one body dimension per thread size; ideally suited for blind, buried and through holes. The ingenious "taper-lock" principle locks-in the Nutsert preventing spin or twist; installs in flat or curved surfaces and is self-tightening with repeated use. The unique design of the installation tool eliminates marring of the parent material surface

Photo not actual size



Material: Mild Steel, Tin Plated
Minimum Grip: .030"

To set Nutserts use tool 11805 & Conversion Kits listed on page 136.

Auveco Part No.	Unit Pkg.	Thread (Class 2B)	A	B	L	M	C	D	Nominal Hole Size	Thousand (In lbs)
10264	25	6-32 U.S.S.	.218"	.238"	.185"	.370"			7/32"	1.50
10265	100									
10266	1000									
10267	25	8-32 U.S.S.	.249"	.264"	.185"	.370"			1/4"	2.00
10268	100									
10269	1000									
10270	25	10-24 U.S.S.	.280"	.300"	.185"	.370"			9/32"	2.25
10271	100									
10272	1000									
10273	25	10-32 S.A.E.	.280"	.300"	.185"	.370"			9/32"	2.25
10274	100									
10275	1000									
10276	25	1/4"-20 U.S.S.	.374"	.398"	.255"	.510"			3/8"	6.00
10277	100									
10278	1000									
10282	10	5/16"-18 U.S.S.	.499"	.524"	.305"	.610"			1/2"	12.87
10283	100									
10284	500									
10288*	10	3/8"-16 U.S.S.	.561"	.590"	.370"	.740"			9/16"	18.00
10289*	50									
10290*	100									

Diameters vary with material density in blind application
Dependent upon material thickness and application

*Cannot be set with Auveco tool 11805, requires pneumatic tool.



11805

Nutsert Hand Tool

For regular and thin sheet Nutserts
(Does not include any conversion kits)

Hand tool only with wrench

UNIT PACKAGE: 1

Conversion Kits for Item 11805 Gun

Size	Use Tool 11805 with Auveco Conversion Kit Listed
6-32 U.S.S.	11807
8-32 U.S.S.	11808
10-32 S.A.E.	11809
10-24 U.S.S.	11810
1/4"-20 U.S.S.	11811
1/4"-28 S.A.E.	11812
5/16"-18 U.S.S.	11813
5/16"-24 S.A.E.	11814
3/8"-16 U.S.S.	11815
M4-.7	12988
M5-.8	12989
M6-1.0	12990
M8-1.25	12991

UNIT PACKAGE: 1



11806

Nutsert Tool Kit in metal case

Includes hand tool 11805, nose piece wrench, and conversion kits (nose piece & mandrel) for the following sizes: 6-32, 8-32, 10-24, 10-32, 1/4"-20 & 5/16"-18.

UNIT PACKAGE: 1

16341

Metric Nutsert Tool Kit in metal case

Includes hand tool 11805, nose piece wrench, and conversion kits (nose piece & mandrel) for the following sizes: M4-.7, M5-.8, M6-1.0 (2 in kit) & M8-1.25.

UNIT PACKAGE: 1



15544

Replacement Mandrel Puller

for Auveco 11805 Nutsert Tool

1/4"-28 Left-Hand Thread

UNIT PACKAGE: 1

THREAD REPAIR INSERTS

Professional Insert Installation Tool



Auveco Tool No.	Installs Insert Sizes (Internal Thread)
12394	1/4"-20 & 1/4"-28
12395	5/16"-18 & 5/16"-24
12396	3/8"-16 & 3/8"-24
12397	7/16"-14 & 7/16"-20
12399	M5-0.8
12400	M6-1.0
16163	5/8"-11 H.D. & 5/8"-18 H.D.
16164	3/4"-10 H.D. & 3/4"-16 H.D.

Economy Driver Tool



12404

Will install approximately 10 Inserts.
Use with Thinwall Inserts up to 1/2" and 10mm internal diameter and Heavy Duty Inserts up to 1/2" internal diameter

UNIT PACKAGE: 5

THREAD REPAIR INSERTS

The easy way to repair stripped threads.

Easy installation with 4 Simple Steps. Instructions must be followed exactly.

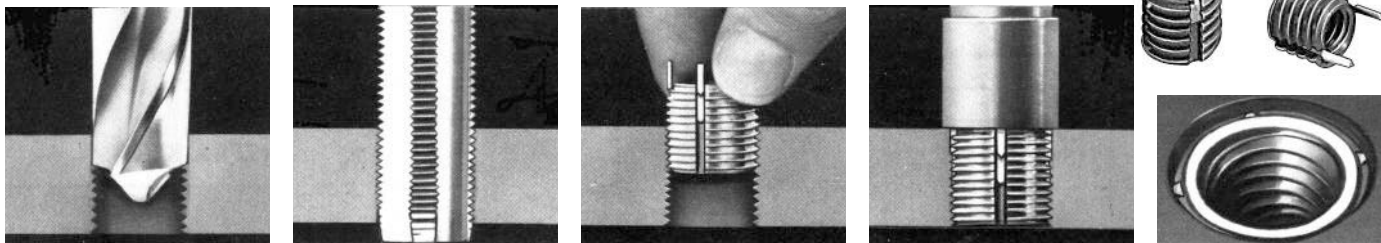

- 1** Drill out old threads, using standard drill.
- 2** Tap new threads, using standard tap.
- 3** Screw in insert until slightly below surface. "Kees" act as depth stop.
- 4** Drive "Kees" down with several light taps on installation tool.
- 5** Installed insert.

Features:

- Installed with standard drills and taps.
- No prewinder tool required.
- Impossible to cross thread while installing.
- No tang break-off.
- May be used in virtually any material: aluminum, magnesium, cast iron, cold rolled steel and plastic.
- Provide high strength and reliability. One length per size provides maximum pullout strength.
- Positive mechanical lock against rotation.
- Breaks Grade 8 bolts in test after test.
- Easy to remove.
- Material: Carbon Steel

Thinwall Inserts

Auveco Part No.	Internal Thread Size (Bolt Size)	External Thread Size	Number of Kees	Insert Length	Drill Size	Tap Size	Professional Installation Tool Part No.	Inserts Per Unit Package
12374	10-24	5/16"-18	2	5/16"	"1"	5/16"-18		4*
17515								25
17516								50
12375	10-32	5/16"-18	2	5/16"	"1"	5/16"-18		4*
17517								25
17518								50
12376	1/4"-20	3/8"-16	2	3/8"	"Q"	3/8"-16	12394	4*
17519								25
12377	1/4"-28	3/8"-16	2	3/8"	"Q"	3/8"-16	12394	4*
17521								25
12378	5/16"-18	7/16"-14	4	7/16"	"X"	7/16"-14	12395	4*
17522								25
17523								50
12379	5/16"-24	7/16"-14	4	7/16"	"X"	7/16"-14	12395	4*
17524								25
12380	3/8"-16	1/2"-13	4	1/2"	29/64"	1/2"-13	12396	3*
17525								25
17526								50
12382	7/16"-14	9/16"-12	4	9/16"	33/64"	9/16"-12	12397	3*
17528								25
12383	7/16"-20	9/16"-12	4	9/16"	33/64"	9/16"-12	12397	3*
17529								25
12384	1/2"-13	5/8"-11	4	5/8"	37/64"	5/8"-11		2*
17530								15
17531								25
12385	1/2"-20	5/8"-11	4	5/8"	37/64"	5/8"-11		2*
17532								15

*Contains Economy Drive Tool No. 12404

Heavy Duty Thread Repair Inserts

Auveco Part No.	Internal Thread Size (Bolt Size)	External Thread Size	Number of Kees	Insert Length	Drill Size	Tap Size	Professional Installation Tool Part No.†	Inserts Per Unit Package
17238	10-24	3/8"-16	2	.31"	"Q"	3/8"-16	•	4
17239	10-32							4
17241	1/4"-28	7/16"-14	2	.37"	"X"	7/16"-14	•	4
17242	5/16"-18	1/2"-13	4	.43"	29/64"	1/2"-13	•	4
17243	5/16"-24							4
17244	3/8"-16	9/16"-12	4	.50"	33/64"	9/16"-12	•	3
17248	1/2"-13	3/4"-16	4	.62"	45/64"	3/4"-16	•	2
17249	1/2"-20							2
16159	5/8"-11	7/8"-14	4	.87"	53/64"	7/8"-14	16163	2
17533								15
16161	3/4"-10	1-1/8"-12	4	1.12"	1-1/16"	1-1/8"-12	16164	2
17535								10

† Not packaged with the Thread Repair Inserts

• Professional tool not available. Can be set with 12404 Economy Drive Tool one kee at a time.

Metric Thread Repair Inserts®

Auveco Part No.	Internal Thread Size (Bolt Size)	External Thread Size	Number of Kees	Insert Length	Drill Size	Tap Size	Professional Installation Tool Part No.†	Inserts Per Unit Package
12386	M5-0.8	M8-1.25	2	.315"	"H"	M8-1.25	12399	3*
17537								15
12387	M6-1.0	M10-1.25	2	.394"	"S"	M10-1.25	12400	3*
17538								15
12389	M8-1.0	M12-1.25	4	.472"	27/64"	M12-1.25	•	2*
17539								10
12390	M8-1.25	M12-1.25	4	.472"	27/64"	M12-1.25	•	2*
17540								10
12391	M10-1.25	M14-1.5	4	.551"	1/2"	M14-1.5	•	2*
17541								10
12392	M10-1.5	M14-1.5	4	.551"	1/2"	M14-1.5	•	2*
17542								10

*Contains Economy Drive Tool 12404

† Not packaged with the Thread Repair Inserts

• Professional tool not available. Can be set with 12404 Economy Drive Tool one kee at a time.

Sec. 09

EXPANSION NUTS

Material: 1010 Steel, Zinc Plated

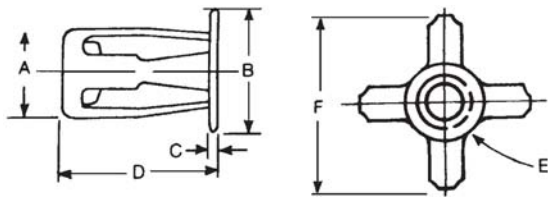

Auveco Part No.	Unit Pkg.	Type	Thread (E)	Body Dia. (A)	Head Dia. (B)	Cap Thick (C)	Overall Length (D)	Grip Range	Required Hole Dia.	Maximum Spread (F)**
13012	25	1	6-32	.318"	.468"	.073"	.653"	1/64"-3/16"	.315"-.330"	.660"
13014	25	1	10-24	.382"	.531"	.073"	.716"	1/64"-3/16"	.385"-.400"	.760"
13016	25	1	1/4"-20	.438"	.625"	.073"	.731"	1/64"-3/16"	.434"-.450"	.890"
13017	25	1	1/4"-20	.438"	.625"	.073"	.919"	3/16"-3/8"	.434"-.450"	.890"

Special Purpose Expansion Nuts

Auveco Part No.	O.E.M. Number	Type	Thread	Finish	O.E.M. Application	Unit Pkg.
12995	GM: 367292 Chry: 6031438	3	1/4"-20	Zinc w/Sealer	GM Mirror Mounting Nut	25
12996	GM: 367292 Chry: 6031438	3	1/4"-20	Zinc w/ Sealer	GM Mirror Mounting Nut	100
12997	GM: 1635218, 10014363	1	M6-1.0	Zinc	GM License Plate Nut	25
12999	GM: 14007940	2	M6-1.0	Zinc w/Raintite	GM "X" & "Y" Roof Rack Mounting Nut	10

Expansion Nut Installation Tools

Photos not actual size



22402

Professional Expansion Nut Installation Tool

UNIT PACKAGE: 1

An economical tool for rapidly installing Expansion Nuts in any material. Takes interchangeable screw rods. Just screw rod into Expansion Nut, push into hole, squeeze to set and remove. Sets all size Expansion Nut Threaded Inserts.

Tool comes with 22403 (6-32 Thread) Installation Rod

Expansion Nut Installation Rods

Use with 22402 Installation Tool



Auveco Part No.	Unit Pkg.	Thread
22403	1	6-32
22404	1	10-24
22405	1	1/4"-20
22406	1	4mm
22407	1	5mm
22408	1	6mm



Mirror Mounting Screws and Expansion Nuts

Auveco Part No.	Description	Unit Pkg.
13231	1/4"-20 x 7/8" Screw (Phos.)	25
13232	1/4"-20 x 7/8" Screw (Phos.) & Expansion Nut	25
14947	M6 x 26mm Screw (Chrome)	25
14976	1/4"-20 x 1-1/4" Screw (Stainless Steel)	25
14977	1/4"-20 x 1-1/4" Screw (Stainless Steel) & Expansion Nut	10

WARNING: Reproductive Harm & Cancer www.P65Warnings.ca.gov

RUBBER NUTS

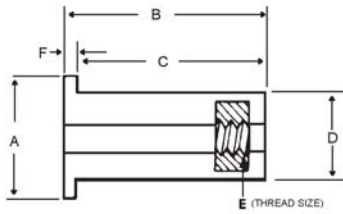

RUBBER NUTS

Material - Neoprene with Captive Brass Nut



Auveco Unit Part No. Pkg.	(A) (E) Thread	(B) Head Dia.	(C) Overall Length	(D) Shank Length	(F) Shank Dia.	Head Thick	Hole Size	For Wall Thickness	O.E.M. Number	O.E.M. Application
13006 25	#6-32	.452"	.499"	.437"	.312"	.062"	5/16"	.015"-.156"		
16236 25	#6-32	.554"	.981"	.946"	.240"	.035"	1/4"	.375"-.607"		
16237 25	#8-32	.438"	.499"	.447"	.312"	.052"	5/16"	.015"-.156"	Chry: 6026166	Rear Compt. Cover Support
13005 25	#8-32	.750"	.575"	.500"	.312"	.062"	5/16"	.015"-.172"	GM: 14048060	License Plate
16240 25	#10-24	.562"	.767"	.580"	.375"	.187"	3/8"	.030"-.227"	GM: 3876130	Voltage Reg & Dome Light
13007 25	#10-32	.500"	.554"	.518"	.377"	.036"	3/8"	.015"-.192"		
13009 10	#10-32	.562"	.665"	.625"	.377"	.040"	3/8"	.035"-.232"	GM: 12338025	Luggage Rack
17586 15	#10-32	.750"	.703"	.625"	.375"	.078"	3/8"	.030"-.227"		
16244 25	#10-32	.750"	.807"	.620"	.375"	.187"	3/8"	.030"-.227"		
13008 10	#10-32	.562"	1.051"	1.000"	.375"	.051"	3/8"	.312"-.643"		
13004 25	1/4"-20	.625"	.641"	.594"	.500"	.051"	1/2"	.015"-.111"	GM: 528846 AMC: 4003120	Luggage Rack
16255 15	1/4"-20	.635"	.801"	.750"	.500"	.051"	1/2"	.187"-.343"		
13010 10	1/4"-20	.740"	.829"	.642"	.500"	.187"	1/2"	.031"-.187"		
16253 25	1/4"-20	.635"	1.051"	1.000"	.500"	.079"	1/2"	.250"-.457"	GM: 342271	Luggage Rack
13011 10	5/16"-18	.875"	.725"	.600"	.620"	.125"	5/8"	.015"-.187"		
16242 25	M5-.8	.500"	.554"	.518"	.375"	.036"	3/8"	.015"-.192"		
16248 25	M5-.8	.562"	.665"	.625"	.375"	.040"	3/8"	.035"-.232"	GM: 14005097	Service Part
13002 10	M6-1.0	.787"	.630"	.579"	.500"	.051"	1/2"	.015"-.094"	GM: 20130258	Station Wagon
13003 50									GM: 14002811	Roof Rack
									GM: 20130258	Station Wagon
									GM: 14002811	Roof Rack
16251 25	M6-1.0	.630"	.630"	.579"	.500"	.051"	1/2"	.015"-.111"	GM: 15505451	Luggage Rack
									AMC: 8934201293	License Plate
16252 25	M6-1.0	.750"	.829"	.642"	.500"	.187"	1/2"	.031"-.187"	VW: 175 820 435	Luggage Rack
24507	10	M1/4"-20								Roof & Luggage Rack
24521	10	M1/4"-.08								Roof & Luggage Rack

WARNING: Reproductive Harm & Cancer www.P65Warnings.ca.gov

TUBULAR TYPE NUTS

Listed by Stud Size

Photo not actual size



3776

Phosphate

Stud Size: 3/32"
Panel Range: .032"-.040"
Fits into 1/8" Hole

UNIT PACKAGE: 100

Photo not actual size



3137

Phosphate

Stud Size: 3/32"
Panel Range: .025"-.175"
Fits into 1/8" Hole

UNIT PACKAGE: 100



2595

Phosphate

Stud Size: 1/8"
Panel Range: .040"-.045"
Fits into 3/16" Hole

UNIT PACKAGE: 100



3777

Phosphate

Stud Size: 1/8"
Panel Range: .038"-.044"
Fits into 5/32" Hole

UNIT PACKAGE: 100



2611

Phosphate

Stud Size: 1/8"
Panel Range: .030"-.036"
Fits into 5/32" Hole

UNIT PACKAGE: 100



5854

(373528-S32), (6000605)
Phosphate

Stud Size: 1/8"
Panel Range: .025"-.045"
Fits into 3/16" Hole

UNIT PACKAGE: 100



5195

(375480-S100)
(3783794)
Phosphate

Stud Size: 1/8"
Panel Range: .036"-.046"
Fits into 1/4" Hole

UNIT PACKAGE: 100



13965

(4006316)
White Nylon

Stud Size: 5/32"
Barrel Length: 1/4"
Head Diameter: 1/4"
Head Thickness: 1/32"
Fits into 3/16" Hole

UNIT PACKAGE: 100



8545

Phosphate

Stud Size: 5/32"
Panel Range: .062"-.068"
Fits into 7/32" Hole

UNIT PACKAGE: 100



8546

Phosphate

Stud Size: 5/32"
Panel Range: .049"-.055"
Fits into 7/32" Hole

UNIT PACKAGE: 100



10073

(6000558)
Phosphate

Stud Size: 3/16"
Panel Range: .038"-.044"
Fits into 7/32" Hole

UNIT PACKAGE: 100



13966

(8934-201-767)
Black Nylon

Stud Size: 3/16"
Barrel Length: 17/64"
Head Diameter: 5/16"
Head Thickness: 1/32"
Fits into 17/64" Hole

UNIT PACKAGE: 100



8578

White Nylon

Thread Screw Size: #10
Fits into 5/16" Hole

UNIT PACKAGE: 50



5196

(354341-S)
Phosphate

Stud Size: 1/4"
Panel Range: .034"-.040"
Fits into 9/32" Hole

UNIT PACKAGE: 100

For Screws



1896

Phosphate

7/32" x 3/8"

Machine Screw Size: #2-56

UNIT PACKAGE: 100



2089

Phosphate

5/16" x 1/2"

Machine Screw Size: #6-32

UNIT PACKAGE: 100



1898

Phosphate

1/2" x 7/8"

Machine Screw Size: #6-32

UNIT PACKAGE: 100



5563

Phosphate

13/32" x 5/8"

Tapping Screw Size: No. 8

UNIT PACKAGE: 100



3793

Phosphate

13/32" x 5/8"

Tapping Screw Size: No. 8

UNIT PACKAGE: 100



1899

Phosphate

1/2" x 7/8"

Machine Screw Size: #8-32

UNIT PACKAGE: 100



2091

Phosphate

5/16" x 1/2"

Machine Screw Size: #8-32

UNIT PACKAGE: 100



1900

Phosphate

1/2" x 7/8"

Tapping Screw Size: #10

UNIT PACKAGE: 100



2092

Phosphate

7/16" x 3/4"

Machine Screw Size: #10-24

UNIT PACKAGE: 100



1912

Phosphate

1/2" x 3/4"

Tapping Screw Size: #12

UNIT PACKAGE: 100



24016

1/2" x 1/4"

Flat Nut for Screw

Sheet Metal Screw Size: #14 (1/4")

UNIT PACKAGE: 100



1903

Phosphate

9/16" x 1"

Machine Screw Size: 1/4"-20

UNIT PACKAGE: 100

For Studs



2098

Phosphate

7/32" x 3/8"

Stud Size: 1/16"

UNIT PACKAGE: 100



2100

Phosphate

1/4" x 7/16"

Stud Size: 3/32"

UNIT PACKAGE: 100



1906

Phosphate

7/32" x 7/16"

Stud Size: .100" or 3/32"

UNIT PACKAGE: 100

FLAT NUTS



2099

Phosphate

5/16" x 9/16"
Stud Size: 1/8"

UNIT PACKAGE: 100



2102

Phosphate

3/8" x 9/16"
Stud Size: 5/32"

UNIT PACKAGE: 100



1905

Phosphate

7/16" x 3/4"
Stud Size: 5/32"

UNIT PACKAGE: 100



2426

Phosphate

3/8" x 5/8"
Stud Size: 3/16"

UNIT PACKAGE: 100



2103

Phosphate

3/8" x 5/8"
Stud Size: 3/16"

UNIT PACKAGE: 100



2105

Phosphate

7/16" x 5/8"
Stud Size: 1/4"

UNIT PACKAGE: 100



3138

Phosphate

1/2" x 11/16"
Stud Size: 5/16"

UNIT PACKAGE: 100

U & J TYPE NUTS BY SCREW SIZE



9625

Phosphate

Screw Size: #6
Panel Range: .090" - .110"
Center of Hole to Edge: 9/32"
UNIT PACKAGE: 100



2346

Phosphate

Screw Size: #8
Panel Range: .025" - .040"
Center of Hole to Edge: 9/32"
UNIT PACKAGE: 100



5571

Phosphate

Screw Size: #8
Panel Range: .025" - .040"
Center of Hole to Edge: 1/4"
UNIT PACKAGE: 100



3796

(9428481)
Phosphate

Screw Size: #8
Panel Range: .025" - .040"
Center of Hole to Edge: 1/4"
UNIT PACKAGE: 100



5836

Phosphate

Screw Size: #8
Panel Range: .025" - .035"
Center of Hole to Edge: 3/8"
UNIT PACKAGE: 100



10666

Phosphate

Screw Size: #8
Panel Range: .025" - .035"
Center of Hole to Edge: 11/32"
UNIT PACKAGE: 100



23527

U-Nut

Screw Size: #8
 Length: .610
 Width: .437
 Panel Range: .045" - .062"
 Center of Hole to Edge: .320
 Ford & General Purpose

UNIT PACKAGE: 50



11292

(445429, 9422552)
 Phosphate

Screw Size: #8
 Panel Range: .045"-.062"
 Center of Hole to Edge: 3/8"

UNIT PACKAGE: 50



11768

(388248-S-36B)
 Phosphate

Screw Size: #8
 Panel Range: .075"-.090"
 Center of Hole to Edge: 9/32"

UNIT PACKAGE: 50

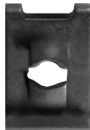

24020

Black

Screw Size: #8
 Length: .610
 Width: .440
 Panel Range: .050" - .090"
 Center of Hole to Edge: .296

UNIT PACKAGE:: 100



19826

(382163-S)
 Phosphate

Screw Size: #8
 Panel Range: .145"-.160"
 Center of Hole to Edge: 9/32"
Replaces Auveco 11063

UNIT PACKAGE: 50



8337

Phosphate

Screw Size: #8-18
 Panel Range: .025"-.040"
 Center of Hole to Edge: 3/8"

UNIT PACKAGE: 50



14822

(25527289)
 Phosphate

Screw Size: M4.2-1.41 (#8)
 Panel Range: .094"-.109"
 Center of Hole to Edge: 7/32"

UNIT PACKAGE: 50



14814

(N803183-S32)
 Phosphate

Screw Size: M4.2-1.41 (#8)
 Panel Range: .094"-.156"
 Center of Hole to Edge: 1/2"

UNIT PACKAGE: 25



18208

Phosphate

Screw Size: #10
 Panel Range: .015"-.085"
 Center of Hole To Edge: 11/32"

UNIT PACKAGE: 100



11429

Phosphate

Screw Size: #10
 Panel Range: .015"-.060"
 Center of Hole to Edge: 15/32"

UNIT PACKAGE: 50



2303

Phosphate

Screw Size: #10
 Panel Range: .027"-.045"
 Center of Hole to Edge: 3/16"

UNIT PACKAGE: 100



3797

Phosphate

Screw Size: #10
 Panel Range: .045"-.062"
 Center of Hole to Edge: 13/32"

UNIT PACKAGE: 100



1913

Phosphate

Screw Size: #10
 Panel Range: .020"-.051"
 Center of Hole to Edge: 15/32"

UNIT PACKAGE: 50



3770

Phosphate

Screw Size: #10
Panel Range: .030"-.037"
Center of Hole to Edge: 3/8"

UNIT PACKAGE: 100



2422

Phosphate

Screw Size: #10
Panel Range: .025"-.064"
Center of Hole to Edge: 3/8"

UNIT PACKAGE: 100



5576

Phosphate

Screw Size: #10
Panel Range: .045"-.062"
Center of Hole to Edge: 13/32"

UNIT PACKAGE: 100



8341

Phosphate

Screw Size: #10
Panel Range: .025"-.060"
Center of Hole to Edge: 11/32"

UNIT PACKAGE: 100



24066

Metal Screw Size: #10
Length: 1.210
Width: .440
Panel Range: .062" - .094"
Center of Hole to Edge: .828

UNIT PACKAGE: 50

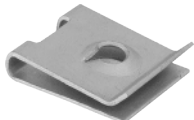

25261

(Audi: WHT-005-296)
Zinc

Fender Apron & Under Cover U-Nut

Screw Size: M4.8-1.61 (#10)
Panel Range: 1.5mm-2.5mm
Center of Hole To Edge: 11mm
Width: 16mm
Length: 19mm

Audi A3, S3 2015 - On, A4 2017 - On, A5, S4, S5 2018 - On,
A6, A7, A8, e-tron, RS5 2019 - On, Q3 2018 - 2015,
S6, S7, S8 2020 - On

UNIT PACKAGE: 25

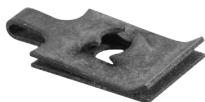

24103

Metal Screw Size: #10
Length: .960
Width: .500
Panel Range: .025" - .040"
Center of Hole to Edge: .562

UNIT PACKAGE: 50



5197

Phosphate

Machine Screw Size: #10-24
Panel Range: .045"-.062"
Center of Hole to Edge: 9/16"

UNIT PACKAGE: 100

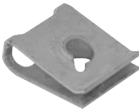

25250

(Acura & Honda: 90331-S3Y-003)
Zinc

Bumper & Wheel Apron U-Nut

Screw Size: M5
Panel Range: 2.0mm-3.5mm
Center of Hole To Edge: 8.0mm
Width: 11.0mm
Length: 14.5mm
Acura ILX 2016 - 2013, NSX 2020 - 2017,
RDX 2007 - On, RL 2012 - 2009,
RLX 2014 - On, TL & TSX 2014 - 2004,
TLX 2015 - On, Honda Accord 2011 - On,
Civic 2009 - On, Clarity 2017 - On,
Crosstour 2015 - 2010,
CR-V 2005 - On, Element 2008,
Fit 2013 - 2012, HR-V 2016 - On,
Insight 2000 - On, S2000 2009 - 2008

UNIT PACKAGE: 50



25411

(Mazda: GSIE-56-496A)
Zinc

Under Cover U-Nut

Screw Size: M6-1.0
Panel Range: 4mm
Center of Hole To Edge: 15mm
Width: 16mm
Length: 24mm
Mazda 3 2020 - 2011, 5 2013 - 2012, 6 2020 - 2014, CX-3,
CX-9 2020 - 2016, CX-30 2020, 5 2016 - 2013

UNIT PACKAGE: 25



2057

Phosphate

Screw Size: #14
Panel Range: .032"-.040"
Center of Hole to Edge: 1/2"

UNIT PACKAGE: 100



2420

Phosphate

Screw Size: #14
Panel Range: .028"-.056"
Center of Hole to Edge: 15/32"

UNIT PACKAGE: 100

U & J TYPE NUTS BY SCREW SIZE, J TYPE CAGE NUTS & SPRING TYPE U NUTS



2293
(9431647)
Phosphate

Machine Screw Size: 1/4"-20
Panel Range: .064"-.125"
Center of Hole to Edge: 9/16"

UNIT PACKAGE: 100



1907
Phosphate

Tapping Screw Size: 5/16"-10
Panel Range: .032"-.064"
Center of Hole to Edge: 1/2"

UNIT PACKAGE: 50

J TYPE CAGE NUTS

Phosphate Finish



Auveco Part No.	Screw Size	Panel Range	Center of Hole to Edge	Unit Pkg.
5586	1/4"-20 USS	.032"-.093"	1/2"	50
3616	5/16"-18 USS	.087"-.093"	9/16"	25
5589	5/16"-18 USS	.087"-.093"	9/16"	50
5170	3/8"-16 USS	.050"-.090"	9/16"	25

SPRING TYPE U NUTS



10064
Phosphate

Screw Size: #6
Panel Range: .025"-.125"
Center of Hole to Edge: 3/8"

UNIT PACKAGE: 50



9879
(9440178, 11504531; 381863-S2)
Phosphate

Screw Size: #8
Panel Range: .025"-.150"
Center of Hole to Edge: 5/8"
GM, Ford

UNIT PACKAGE: 100



10065
Phosphate

Screw Size: #8
Panel Range: .025"-.125"
Center of Hole to Edge: 3/8"

UNIT PACKAGE: 25



20582
(9433156)
Phosphate

Screw Size: #8
Panel Range: .125" - .250"
Center of Hole to Edge: 3/8"
GM

UNIT PACKAGE: 100

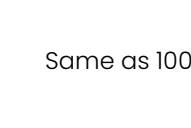

16267

Same as 10065 except for unit package quantity

UNIT PACKAGE: 100



9880

(9424837, 9431530; 381818-S2)
Phosphate

Screw Size: #8
Panel Range: .025"-.150"
Center of Hole to Edge: 3/8"
GM, Ford

UNIT PACKAGE: 100



10066
Phosphate

Screw Size: #10
Panel Range: .025"-.125"
Center of Hole to Edge: 11/32"

UNIT PACKAGE: 25

SPRING TYPE U NUTS & U-TYPE SPECIAL NUTS



15752

Phosphate

Screw Size: #10
Panel Range: .025"-.150"
Center of Hole to Edge: 9/16"

UNIT PACKAGE: 50



10067

Phosphate

Screw Size: #14
Panel Range: .025"-.125"
Center of Hole to Edge: 3/8"

UNIT PACKAGE: 25



9881

(9425491)
Phosphate

Screw Size: #14
Panel Range: .025"-.150"
Center of Hole to Edge: 5/16"
GM

UNIT PACKAGE: 100

U-TYPE SPECIAL NUTS



14526

(N802538-S100)
Green Phosphate

Screw Size: #8
Panel Range: 1/16"-5/32"
Center of Hole to Edge: 5/16"
Width: 17/32", Length: 51/64"
Ford

UNIT PACKAGE: 50



14750

(Toyota: 53879-14010-A,
53879-14020, 53879-22030;
GM: 94841226;
Mazda: LA01-56-135)

**Nylon U-Nut Fender/
Wheel Housing Applications**

Screw Size: #10
Panel Range: Up to 1mm
Center of Hole to Edge: 11mm
Width: 20mm, Length: 31mm
Toyota, Geo Prizm, Nova & Mazda

UNIT PACKAGE: 15



14527

(10041588, 25530441)
Phosphate

Screw Size: #8
Panel Range: 1/16"-3/16"
Center of Hole to Edge: 19/32"
Width: 35/64", Length: 1-1/32"
GM

UNIT PACKAGE: 50

19669

Same as 14750 except for unit package quantity

UNIT PACKAGE: 25



19162

(1638575, 25512688)
Zinc

Screw Size: M4.2 (#8)
Panel Range: .035"-.049"
Center of Hole to Edge: 9/16"
GM

UNIT PACKAGE: 25



20956

(90467-05114)
Black Nylon

**Bumper & Fender Apron
Nylon U-Nut**

Screw Size: M5.5 (#12)
Center of Hole to Edge: 14mm
Panel Range: Up to 1mm
Width: 20mm, Length: 36mm
Lexus & Toyota

UNIT PACKAGE: 10

EXTRUDED U-NUTS

Fold Over Nuts



10048
(45262)
Phosphate

Screw Size: #8-32
Panel Range: .025"-.150"
Center of Hole to Edge: 3/8"
Ford

UNIT PACKAGE: 50



15677
(152273)

Phosphate
Screw Size: #10-24
Panel Range: .025"-.125"
Center of Hole to Edge: 15/32"
GM

UNIT PACKAGE: 50



24127
Steel

Screw Size: #10-24
Panel Range: .140"-.160"
Center of Hole to Edge: 0.480"
Overall Length: .900"
Overall Width: .670"

UNIT PACKAGE: 50



8359
(1480627; 1494252)
Phosphate

Screw Size: 1/4"-20
Panel Range: .025"-.150"
Center of Hole to Edge: 17/32"
GM

UNIT PACKAGE: 50



10050
(45263-S2)
Phosphate

Screw Size: 1/4"-20
Panel Range: .025"-.150"
Center of Hole to Edge: 17/32"
Ford

UNIT PACKAGE: 25



24094
Steel

Screw Size: 1/4"-20
Panel Range: .050"-.070"
Center of Hole to Edge: .0620"
Overall Length: 1.100"
Overall Width: 1.100"

UNIT PACKAGE: 25



10051
(45267; 1494257)
Phosphate

Screw Size: 1/4"-20
Panel Range: .025"-.150"
Center of Hole to Edge: 25/32"
Ford, GM

UNIT PACKAGE: 50



8375
(152266)
Phosphate

Screw Size: 5/16"-18
Panel Range: .025"-.060"
Center of Hole to Edge: 9/16"
GM

UNIT PACKAGE: 50



10053
(Chry: 6023171; Ford: 45264)
Phosphate

Screw Size: 5/16"-18
Panel Range: .025"-.150"
Center of Hole to Edge: 9/16"
Ford

UNIT PACKAGE: 50



12265
(45264-S2)
Phosphate

Screw Size: 5/16"-18
Panel Range: .040"-.125"
Center of Hole to Edge: 9/16"
Ford

UNIT PACKAGE: 50



8372
(152267)
Phosphate

Screw Size: 5/16"-18
Panel Range: .120"-.150"
Center of Hole to Edge: 9/16"
GM

UNIT PACKAGE: 50



10830
(1494253)
Phosphate

Screw Size: 5/16"-18
Panel Range: .025"-.150"
Center of Hole to Edge: 9/16"
GM

UNIT PACKAGE: 50



8814
(1494258; 379831-S)
Phosphate

Screw Size: 5/16"-18
Panel Range: .025"-.150"
Center of Hole to Edge: 27/32"
GM & Ford

UNIT PACKAGE: 25



10052
(10008002; 45268-S2)
Phosphate

Screw Size: 5/16"-18
Panel Range: .025"-.150"
Center of Hole to Edge: 7/8"
GM & Ford

UNIT PACKAGE: 25

EXTRUDED U-NUTS

Fold Over Nuts



10054

(1494254, 12337873, 45265-S2)
Phosphate

Screw Size: 3/8"-16
Panel Range: .050"- .200"
Center of Hole to Edge: 3/4"
GM & Ford

UNIT PACKAGE: 25



10055

(45269)
Phosphate

Screw Size: 3/8"-16
Panel Range: .050"- .200"
Center of Hole to Edge: 1-1/8"
Ford

UNIT PACKAGE: 25

Metric Extruded U-Nuts



18337

(GM: 11500654;
Ford: N623330-S2)
Zinc Organic

Screw Size: M4-7
Panel Range: .60mm-3.8mm (.024"- .150")
Center of Hole to Edge: 9.5mm (3/8")
GM & Ford

UNIT PACKAGE: 50



11625

(11500655)
Phosphate

Screw Size: M4-7
Panel Range: .80mm-4.00mm (.030"- .160")
Center of Hole to Edge: 13.5mm (17/32")
GM

UNIT PACKAGE: 50



20339

(GM: 11516397,
Ford W707291-S439)
Zinc Organic

Locking Thread
Screw Size: M4.2-1.41 (#8)
Panel Range: .5mm-2.0mm (.020"- .079")
Center of Hole to Edge: 10mm (25/64")
GM Various 2012 - 1997, Buick Enclave 2018 - 2020,
Encore 2013 - On, Regal 2020 - 2018,
Cadillac CT6 2020 - 2016, ELR 2016, XTS 2019 - 2018,
Bolt 2020 - 2017, Camaro 2016 - On,
Spark 2014 - On, Trax 2020 - 2019, Volt 2019 - 2016,
Terrain 2017 - 2016; Ford Edge 2014 - 2007,
Expedition 2017 - 2015, Explorer 2011 - On,
F150 2014 - 2004, Fiesta 2019 - 2011, Flex 2019 - 2013,
Focus 2011 - 2008, Mustang 2010 - On,
Taurus 2018 - 2010, Transit 150-350 2015 - On,
Lincoln MKT 2019 - 2010, MKX 2015 - 2007,
Mark LT 2014 - 2006, Navigator 2017 - 2009

UNIT PACKAGE: 50



21040

(Ford: W520813-S439; 11513599)
Zinc Organic

Locking Thread
Screw Size: M4.2-1.41 (#8)
Panel Range: .65mm-3.8mm (.025"- .150")
Center of Hole to Edge: 9.5mm (3/8")
GM

UNIT PACKAGE: 25

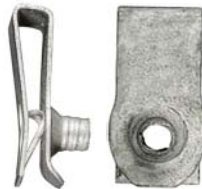

22074

(GM: 11515638)
Zinc Organic

Locking Thread
Metric Extruded U-Nut
Screw Size: M4.2-1.41 (#8)
Panel Range: .65mm-3.80mm (.025"- .150")
Center of Hole to Edge: 15mm
GM

UNIT PACKAGE: 25



22702

(Ford: W708991-S439)
Silver-Zinc Organic

Metric U-Nut
Screw Size: M4.2-1.41 (#8)
Panel Range: 2mm - 3.4mm (.079" - .137")
Center of Hole to Edge: 9.5mm (3/8")
Fender Apron & Mud Flap
Ford Expedition, F-150/250/350/450/550,
Transit and Lincoln Mark LT
& Navigator 2005 - On

UNIT PACKAGE: 25



22582

(GM: 11548579)
Zinc Organic

Metric Extruded U-Nut
Screw Size: M4.2-1.41 (#8)
Panel Range: 2.0mm - 3.0mm (.078" - .118")
Center of Hole to Edge: 9.5mm (3/8")
Buick Cascada, Encore, Envision, LaCrosse,
Cadillac ATS, CTS, XTS, Chevrolet Camaro,
Cruze, Equinox, Malibu, Sonic, Traverse,
Trax & GMC Terrain 2017 - On

UNIT PACKAGE: 25



22583

(GM: 11548580)
Zinc Organic

Metric Extruded U-Nut
Screw Size: M4.2-1.41 (#8)
Panel Range: .65mm - 3.8mm (.026" - .149")
Center of Hole to Edge: 15mm (19/32")
Cadillac XTS and Conv/Camaro, Chevrolet
Cruze, Equinox, & Traverse 2017 - On

UNIT PACKAGE: 25

EXTRUDED U-NUTS

Fold Over Nuts

Sec. 09



22578

(Chrysler: 6509799-AA)
Zinc Organic

Metric Extruded U-Nut
Screw Size: M4.8-1.6 (#10)
Panel Range: .61mm - 3.8mm (.024" - .149")
Center of Hole to Edge: 11.5mm (.452")
Chrysler 200 & Pacifica and Dodge Dart
& Ram and Jeep Cherokee 2010 - On

UNIT PACKAGE: 25

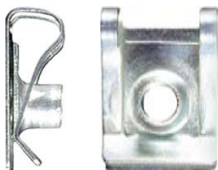

22113

(BMW: 51127070202;
VW: N90168602)
Zinc Finish

Metric Extruded U-Nut
Screw Size: M5-.8
Panel Range: .45mm - 1.5mm
Center of Hole to Edge: 11.5mm
BMW 1999 - 1992
VW 1993 - On

UNIT PACKAGE: 25



18338

(GM: 11505596; Ford: N623331-S2)
Phosphate

Screw Size: M5-.8
Panel Range: .60mm-3.8mm (.024"-.150")
Center of Hole to Edge: 11mm (7/16")
GM, Ford

UNIT PACKAGE: 50



11626

(11500657)
Phosphate

Screw Size: M5-.8
Panel Range: .80mm-4.00mm (.030"-.160")
Center of Hole to Edge: 15.8mm (5/8")
GM

UNIT PACKAGE: 50



22539

(Chrysler: 6105242-AA)
Magni-554 Silver

Metric Extruded U-Type Nut
Screw Size: M6-1.0
Center of Hole to Edge: 13mm
Panel Range: 0.5mm - 4.00mm
Quarter Panel & Fender
Chrysler 200 & Pacifica, Dodge
Challenger, Charger, Dart & Ram and
Jeep Cherokee, Grand Cherokee &
Renegade 2009 - On

UNIT PACKAGE: 25

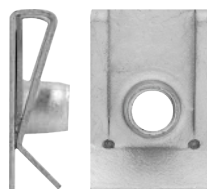

22841

(BMW: 51-12-7-070-202)
Zinc Organic

Metric Extruded U-Nut
Screw Size: M6-1.0
Panel Range: .5mm Max.
Center of Hole to Edge: 11.5mm
BMW 321i, 328d, 328i, 328i GT, 330e, 330i,
330i GT, 335d, 335i, 335 GT, 335is, 340i, 340i
GT, 428i, 428i Gran Coupe, 430i, 430i Gran
Coupe, 435i, 435i Gran Coupe, 440i, 440i
Gran Coupe, 528i, 535i, 550i, 645Ci, 650i,
740Li, 750Li, 750i, 760Li, M3, M4,
M6, X3 & X5 2006 - On

UNIT PACKAGE: 25



21540

(GM: 24449408)
Orange Nylon

Screw Size: M5.5 (#12)
Panel Range: Up to 2mm (.079")
Center of Hole to Edge: 12mm (15/32")
GM & Saab

Use with Auveco 21541

UNIT PACKAGE: 25



25057

(Mercedes: 000-990-32-62)
Black Nylon

Bumper Pipe Shield Extension U-Nut

Screw Size: M6
Width: 17mm
Length: 23.7mm
Panel Range: 3mm Max.
Center of Hole to Edge: 12mm
Mercedes CLS400 2018 - 2015;
CLS550, CLS63 AMG 2018 - 2012; E250, E350 2016 - 2014;
E400 2017 - 2014; E550 2017 - 2010; E63 AMG 2016 - 2014;
GL350, GL460, GL 550 2012 - 2010; GLC300 2019 - 2016;
GLC350e 2019 - 2018; GLC43 AMG 2019 - 2017;
GLC63 AMG 2019 - 2018; GLE43 AMG 2019 - 2017;
GLE450 AMG 2016; GLE63 AMG 2019 - 2016;
GLK250, GLK350 2015 - 2013

UNIT PACKAGE: 25

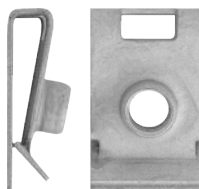

22865

(Ford: W712324-S439)
Zinc Organic

Bumper Deflector U-Nut

Screw Size: M6-1.0
Panel Range: 0.7mm-2.0mm
Center of Hole to Edge: 12mm
Ford Ranger 2019 - On

UNIT PACKAGE: 10



16846

(6502152)
Phosphate

Tri-Lobular Locking Thread
Screw Size: M6-1.0
Panel Range: .80mm-4.00mm (.030"-.160")
Center of Hole to Edge: 12mm (15/32")
Chrysler

UNIT PACKAGE: 50

EXTRUDED U-NUTS

Fold Over Nuts



16842
(11504047; N802331-S53)
Phosphate

Screw Size: M6-1.0
Panel Range: 3.4mm-6.3mm (.140"-.250")
Center of Hole to Edge: 13.5mm (17/32")
GM & Ford

UNIT PACKAGE: 25



18449
(6101308)
Phosphate

Locking Thread
Screw Size: M6-1.0
Panel Range: .80mm-4.00mm (.030"-.160")
Center of Hole to Edge: 13.5mm (17/32")
Chrysler

UNIT PACKAGE: 50



11864
(11503714,11503716)
Phosphate

Screw Size: M6-1.0
Panel Range: .80mm-4.00mm (.030"-.160")
Center of Hole to Edge: 13.5mm (17/32")
GM

UNIT PACKAGE: 50



12669
(1016937, 11503957; 12337917
N623332-S2, -S53 & -S100;
W5220822-S426)
Phosphate

Screw Size: M6-1.0
Panel Range: .80mm-4.00mm (.030"-.160")
Center of Hole to Edge: 13.5mm (17/32")
GM, Ford

UNIT PACKAGE: 25

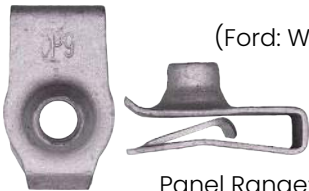

22584
(Ford: W520802-S439; Nissan: 01241-0009U)
Zinc Organic

Metric Extruded U-Nut
Screw Size: M6-1.0

Panel Range: .80mm-4.00mm (.030"-.160")
Center of Hole to Edge: 13.5mm (17/32")

Ford Bronco, Bronco Sport 2021-On,
E-150, 250 2014-2009, Edge 2021-2007, Escape 2020-On,
Explorer 2021-2011, Expedition 2021-2018,
E-150, E-250 2014-2008, E-350 2021-2008,
F-150, F-250, F-350 2021-2008, Flex 2019-2009,
Focus 2011-2008, Fusion 2020-2013,
Mustang 2018-2015, Ranger 2019-On,
Transit-150, 350, 350 HD 2020-2015;
Lincoln Aviator 2020-On, Corsair 2021-2020,
MKX 2018-2007, MKT 2019-2010, MKZ 2020-2013,
Navigator 2020-2018, Nautius 2020-2019;
Nissan Altima 2077-On,
Armada, Titan 2015-2004, Frontier 2021-2005,
Leaf 2013-On, Maxima 2009-On, Murano 2015-On,
Pathfinder 2005-On, Rogue 2017-2014, Xterra 2015-2005

UNIT PACKAGE: 25



22579
(Ford: W520822-S439;
Chrysler: 6510185-AA,
6101956, 6503694)
Zinc Organic

Metric Extruded U-Nut

Screw Size: M6-1.0
Panel Range: .8mm - 4.0mm
(.030" - .160")

Center of Hole to Edge: 13.5mm (17/32")
Chrysler 300, Pacifica, Prowler, PT Cruiser,
Sebring & Town & Country and Dodge
Caravan, Challenger, Charger, Durango,
Magnum, Nitro,Ram, Stratus & Viper and
Jeep Commander,Grand Cherokee &
Wrangler 1996 - On

UNIT PACKAGE: 25



22581
(GM: 11611321)
Zinc Organic

Metric Extruded U-Nut

Screw Size: M6-1.0
Panel Range: .70mm - 2.0mm
Center of Hole to Edge: 14mm
Buick Envision, LaCrosse, Cadillac XTS,
Chevrolet Bolt EV, Colorado, Cruze,
Equinox, Impala, Traverse, Volt & GMC
Acadia Canyon & Terrain 2017 - On

UNIT PACKAGE: 10



22837
(Ford: W705958-S439)
Zinc Organic

Metric Extruded U-Nut

with Locking Thread
Screw Size: M6-1.0
Panel Range: .5mm - 2.3mm
(.019" - .090")

Center of Hole to Edge: 14.5mm (9/16")
Ford F-150 & F350 2018 - On

UNIT PACKAGE: 10



22105
(Honda: 90675-SA5-003)
Zinc

Metric Extruded U-Nut

Screw Size: M6-1.0
Panel Range: 2mm - 4mm
Center of Hole to Edge: 14.5mm (9/16")
Acura 2007 - 1998; Honda 2014 - 1983

UNIT PACKAGE: 25



12666
(11504978)
Zinc Organic

Screw Size: M6-1.0
Panel Range: 3.4mm-6.3mm (1.35"-.250")
Center of Hole to Edge: 14.5mm (9/16")
GM

UNIT PACKAGE: 25

EXTRUDED U-NUTS

Fold Over Nuts



20416

(11516372)
Zinc Organic

Screw Size: M6-1.0
Panel Range: 2.0mm-5.0mm (.079" - .197")
Center of Hole to Edge: 14.5mm (9/16")
GM

UNIT PACKAGE: 25



12575

(11503715, 11508241,
11609385)

Phosphate

Screw Size: M6-1.0
Panel Range: .80mm-4.0mm (.030"-.160")
Center of Hole to Edge: 19.5mm (25/32")
GM Express & Savana Vans 2001 - On

UNIT PACKAGE: 25



16322

(14040999)
Phosphate

Screw Size: M6-1.0
Panel Range: 1.0mm-2.5mm (.045"-.095")
Center of Hole to Edge: 19.5mm (25/32")
GM

UNIT PACKAGE: 50



19480

(N805889-S100)
Phosphate

Screw Size: M6-1.0
Panel Range: 4.3mm-5.6mm
(.172"-.219")
Center of Hole to Edge: 21mm (13/16")
Ford

UNIT PACKAGE: 15



11628

(9433043, 11500658)
Phosphate

Screw Size: M6.3-1.0
Panel Range: .80mm-4.00mm (.030"-.160")
Center of Hole to Edge: 13.5mm (17/32")
GM

UNIT PACKAGE: 25



12667

(11503455, 11504288)
Zinc Organic

Screw Size: M8-1.25
Panel Range: 1.50mm-5.50mm
(.060"-.216")
Center of Hole to Edge: 14.5mm (9/16")
GM

UNIT PACKAGE: 25



11629

(11500660, 11502617;
N623333-S2; 6101283)
Phosphate

Screw Size: M8-1.25
Panel Range: .80mm-4.00mm (.030"-.160")
Center of Hole to Edge: 14.5mm (9/16")
GM, Ford, Chrysler

UNIT PACKAGE: 25



22700

(Ford: N800296-S439,
W520823-S439)
Zinc

**Metric Extruded U-Nut
with Locking Thread**

Screw Size: M8-1.25
Panel Range: .80mm - 4.00mm
(.030" - .160")

Center of Hole to Edge: 14.5mm (9/16")
Ford Expedition, Explorer, Explorer Sport,
F-150/250/350/450/550, Freestar,
Mustang & Taurus and Lincoln MKT
& Navigator and Mercury Monterey
& Mountaineer 2002 - On

UNIT PACKAGE: 15



22838

(GM: 11548585)
Zinc Organic

Metric Extruded U-Nut

Screw Size: M8-1.25
Panel Range: .8mm - 4.0mm
Center of Hole to Edge: 15mm
Chevrolet Express &
GMC Savana 2018 - On

UNIT PACKAGE: 15



11630

(11500661, 11503317,
11516150;
N623343-S2 & S100)
Phosphate

Screw Size M8-1.25
Panel Range: .80mm-4.00mm (.030"-.160")
Center of Hole to Edge: 20mm (13/16")
GM, Ford

UNIT PACKAGE: 25



22699

(Ford: W520813-S439;
GM: 11516150)
Zinc

Metric Extruded U-Nut

Screw Size: M8-1.25
Panel Range: .80mm - 4.00mm
(.030" - .160")
Center of Hole to Edge: 21mm
(13/16")

Fender Liner
Ford F-150/250/350 & Mustang 2015 - On
Chevrolet Colorado &, Express Van and
GMC Canyon & Savana Van 2015 - On

UNIT PACKAGE: 15



19644

(10084751)
Phosphate

Screw Size: M8-1.25
Panel Range: 1.7mm-5.5mm (.067"-.217")
Center of Hole to Edge: 28.5mm (1-1/8")
GM

UNIT PACKAGE: 15



25045

(GM: 11569971)
Silver Magni 565

Fender Panel U-Nut

Screw Size: M8-1.25
Panel Range: 3mm
Center of Hole to Edge:
27.3mm
Cadillac Escalade & GMC
Yukon 2014 - 2007;
Chevrolet Avalanche
2013 - 2007; Silverado,
Suburban, Tahoe &
GMC Sierra 2018 - 2007

UNIT PACKAGE: 5



18401

(N801117-S100)
Magni-565

Locking Thread
Screw Size: M8-1.25
Panel Range: 4mm-7mm (.157"-.276")
Center of Hole to Edge: 21mm (13/16")
Ford

UNIT PACKAGE: 25



11631

(11500662, 22531616)
Phosphate

Screw Size: M10-1.50
Panel Range: 1.0mm-6.0mm
(.040"-.230")
Center of Hole to Edge: 19mm (3/4")
GM

UNIT PACKAGE: 25



18339

(GM: 11500663;
Ford: N623344-S2)
Zinc Organic

Screw Size: M10-1.5
Panel Range: 1.5mm-5.5mm (.060"-.215")
Center of Hole to Edge: 28mm (1-3/32")
GM, Ford

UNIT PACKAGE: 25

FasTrack Web is your
next step to savings.
Recover money spent on
repair fasteners during
collision repair jobs.

Go to auveco.com to
learn more about
Auveco's FasTrack Web

**"Your body shop cost
recovery system."**



Countersunk Type Washers

Screw Size	I.D.	O.D.	Nickel Plated Brass			Black Ebonol Plated Brass	
			Unit Pkg.	Unit Pkg.	Unit Pkg.	Part No.	Unit Pkg.
#4	9/64"	3/8"	612▲		7613		
#6	11/64"	7/16"	614▲	7143	7615	16011	100
#8	13/64"	1/2"		7145	7616	16012	100
#10	1/4"	19/32"	618▲	7147	7618	16013	100
#12	9/32"	11/16"	619▲	7148			



Flanged Type Countersunk Washers

Screw Size	I.D.	O.D.	Nickel on Brass Part No.	Black Oxide on Brass Part No.	Stainless Steel Part No.	Unit Pkg.
#6	5/32"	1/2"	3469		3470	100
#8	13/64"	5/8"	2515	16009	2597	100
#10	1/4"	11/16"	3471		3472	100



Flush Type Washers Nickel Plated on Brass

Unit Pkg.	Unit Pkg.	Unit Pkg.	Screw Size	I.D.	O.D.
100	144	1000			
	7137	7624	#6	5/32"	11/32"
604▲	7138		#8	3/16"	3/8"
16015		16016	#10	13/64"	15/32"

Nylon Finishing Washers

Available in natural or black nylon.
 These molded washers protect cabinets from scratching, cover misaligned holes, etc.
 May also be used as guides, bumpers and spacers.

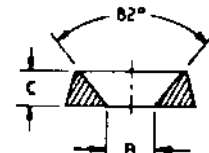
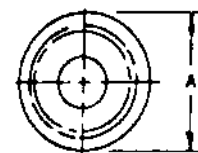

Auveco Part No.	Screw Size	O.D. (A)	I.D. (B)	Thickness (C)	Color	Unit Pkg.
13717	#6	.437" (11.10mm)	.143" (3.63mm)	.100" (2.54mm)	Black	50
13718	#8	.515" (13.08mm)	.171" (4.34mm)	.115" (2.92mm)	Natural	50
13719	#8	.515" (13.08mm)	.171" (4.34mm)	.115" (2.92mm)	Black	50
13720	#10	.580" (14.73mm)	.191" (4.85mm)	.152" (3.86mm)	Natural	50
13721	#10	.580" (14.73mm)	.191" (4.85mm)	.152" (3.86mm)	Black	50
13723	#12	.609" (15.47mm)	.225" (5.72mm)	.160" (4.06mm)	Black	50
13724	#14	.683" (17.35mm)	.251" (6.38mm)	.183" (4.65mm)	Natural	50
13725	#14	.683" (17.35mm)	.251" (6.38mm)	.183" (4.65mm)	Black	50



USS (Wrought) Washers

Bolt Size	I.D.	O.D.	Thickness	Zinc Part No.	Plain Part No.	Unit Pkg.
3/16"	1/4"	9/16"	3/64"	8605		100
1/4"	5/16"	3/4"	1/16"	8606	3929	100
5/16"	3/8"	7/8"	1/16"	8607	3930	100
3/8"	7/16"	1"	5/64"	8608	3931	100
7/16"	1/2"	1-1/4"	5/64"	8609	3932	100
1/2"	9/16"	1-3/8"	7/64"	8610	3933	100
9/16"	5/8"	1-1/2"	7/64"	8611		100
5/8"	11/16"	1-3/4"	9/64"	8612	3935*	50
3/4"	13/16"	2"	5/32"	8613		50

* Unit package quantity is 100



SAE Washers Zinc

Auveco Part No.	Bolt Size	I.D.	O.D.	Thickness	Unit Pkg.
3984	#6 (1/8")	5/32"	3/8"	3/64"	100
16721	#8 (5/32")	3/16"	7/16"	3/64"	100
3985	#10 (3/16")	7/32"	1/2"	1/16"	100
3986	1/4"	9/32"	5/8"	1/16"	100
3987	5/16"	11/32"	11/16"	1/16"	100
3988	3/8"	13/32"	13/16"	1/16"	100
3989	7/16"	15/32"	15/16"	1/16"	100
3990	1/2"	17/32"	1-1/16"	3/32"	100
3991	9/16"	19/32"	1-3/16"	3/32"	100
3992	5/8"	21/32"	1-5/16"	3/32"	100
3993	3/4"	13/16"	1-1/2"	1/8"	100

▲WARNING: Cancer - www.P65Warnings.ca.gov



High Strength Grade 8 Washers

1035 Steel • R/C38-45 Hardness • Zinc & Gold Dichromate Finish

For use with Grades 5 and 8 Bolts

USS Sizes

Auveco Part No.	Bolt Size	I.D.	O.D.	Thick-ness	Unit Pkg.
12771	1/4"	5/16"	3/4"	.051/.080"	100
12772	5/16"	3/8"	7/8"	.064/.104"	100
12773	3/8"	7/16"	1"	.064/.104"	100
12774	7/16"	1/2"	1-1/4"	.064/.104"	50
12775	1/2"	9/16"	1-3/8"	.097/.121"	50
12776	9/16"	5/8"	1-1/2"	.097/.121"	25
12777	5/8"	11/16"	1-3/4"	.108/.160"	25
12778	3/4"	13/16"	2"	.122/.177"	10
12779	7/8"	15/16"	2-1/4"	.136/.192"	10

SAE Sizes

Auveco Part No.	Bolt Size	I.D.	O.D.	Thick-ness	Unit Pkg.
12781	1/4"	9/32"	5/8"	.055/.072"	100
12782	5/16"	11/32"	11/16"	.055/.072"	100
12783	3/8"	13/32"	13/16"	.055/.072"	100
12784	7/16"	15/32"	59/64"	.055/.072"	50
12785	1/2"	17/32"	1-1/16"	.097/.121"	50
12786	9/16"	19/32"	1-3/16"	.097/.121"	50
12787	5/8"	11/16"	1-5/16"	.122/.146"	25
12788	3/4"	13/16"	1-15/32"	.122/.146"	25
12789	7/8"	15/16"	1-3/4"	.136/.160"	15
12790	1"	1-1/8"	2"	.136/.160"	10

⚠ WARNING: ALL ITEMS IN CHART Reproductive Risk & Cancer - www.P65Warnings.ca.gov



Spring Type Lock Washers

Grade 5 • Zinc

Auveco Part No.	Bolt Size	Unit Pkg.
5717	#6 (1/8")	200
5718	#8 (5/32")	200
5719	#10 (3/16")	200
24034	#12	200
5721	5/16"	200
5722	3/8"	200
5723	7/16"	200
5724	1/2"	200
8649	9/16"	100
8650	5/8"	100



Copper Washers

Auveco Part No.	Bolt Size	I.D.	O.D.	Thick-ness	Unit Pkg.
15911	3/16"	1/4"	7/16"	1/32"	50
15914	3/16"	1/4"	5/8"	1/16"	25
15912	1/4"	5/16"	1/2"	1/32"	50
15915	1/4"	5/16"	11/16"	1/16"	25
15913	5/16"	3/8"	9/16"	1/32"	50
15916	5/16"	3/8"	3/4"	1/16"	25
15917	3/8"	7/16"	13/16"	1/16"	25
15918	7/16"	1/2"	7/8"	1/16"	25
15919	1/2"	9/16"	13/16"	3/32"	25



Belleville Washers

Phosphate and Oil

Auveco Part No.	Bolt Size	I.D.	O.D.	Thick-ness	Unit Pkg.
14847	1/4"-6mm	.255"	.500"	.022"	50
14848	1/4"-6mm	.255"	.500"	.038"	50
14850	5/16"-8mm	.317"	.625"	.047"	50
14851	3/8"-10mm	.380"	.750"	.034"	25



Bowed Spring Washers

Black Parkerized

Auveco Part No.	Bolt Size	I.D.	O.D.	Thick-ness	Unit Pkg.
9630	3/8"	25/64"	3/4"	1/64"	50

High Alloy Lock Washers

Grade 8

Yellow Zinc Dichromate

For use with Grade 5 & 8 Bolts



Auveco Part No.	Bolt Size	Unit Pkg.
11925	1/4"	100
11926	5/16"	100
11927	3/8"	100
11928	7/16"	50
11929	1/2"	50
11931	5/8"	50
11933	7/8"	25

⚠ WARNING: ALL ITEMS IN CHART Reproductive Risk & Cancer - www.P65Warnings.ca.gov

For fastener assortments refer to assortments 1020 and 1030 in the green pages.



Fender Washers

Zinc Plated

Auveco Part No.	Bolt Size	I.D.	O.D.	Thickness	Unit Pkg.
2007	3/16"	7/32"	1/2"	3/64"	100
1183	3/16"	7/32"	3/4"	3/64"	100
16018	3/16"	7/32"	1"	3/64"	100
16019	3/16"	7/32"	1-1/4"	3/64"	50
2008	1/4"	9/32"	5/8"	3/64"	100
16020	1/4"	9/32"	1"	1/16"	100
2333	1/4"	9/32"	1-1/4"	1/16"	100
16021	1/4"	9/32"	1-1/2"	3/64"	50
1376	5/16"	21/64"	3/4"	1/16"	100
768	5/16"	11/32"	1-1/4"	3/64"	100
17095	5/16"	11/32"	1-1/4"	1/8"	25
1700	5/16"	11/32"	1-1/2"	3/64"	50
3553	3/8"	13/32"	1-1/4"	1/16"	100
2227	3/8"	13/32"	1-1/2"	3/64"	50
16022	3/8"	27/64"	1-5/8"	1/16"	50
1294	3/8"	7/16"	1-3/4"	1/16"	25
17094	3/8"	7/16"	1-3/4"	1/8"	25
24035	7/16"	0.468"	1-3/8"	0.050-0.070"	100
3554	1/2"	17/32"	1-1/4"	3/64"	100
3556	1/2"	17/32"	1-1/2"	3/64"	100
16023	1/2"	17/32"	2"	1/16"	25



Vibration Proof Lock Washers

Zinc Flake Coated

For use with Grade 5, Grade 8 & ASTM 574 High Grade Bolts

These washers have cams or wedges on one side, a lead angle greater than a thread angle, and radial teeth or ribs on the other side. The washers are installed cam face to cam face. When tightening the fastener to preload, the teeth penetrate and seat against the joint material and the nut and/or fastener head. When subjected to vibration the interacting cams create a wedge action which prevents the fastener from vibrating loose.

Material: Carbon Steel

Hardness: Through Hardened: 465HVI

Auveco Part No.	Bolt Size	O.D.	Unit Pkg.
19282	3/16" (5mm)	11/32"	50 (25 pr.)
19283	1/4" (6mm)	27/64"	50 (25 pr.)
19284	5/16" (8mm)	17/32"	50 (25 pr.)
19285	3/8" (10mm)	21/32"	50 (25 pr.)
19286	7/16" (11mm)	23/32"	30 (15 pr.)
19287	1/2" (12mm)	49/64"	20 (10 pr.)
19288	9/16" (14mm)	29/32"	20 (10 pr.)
19289	5/8" (16mm)	1"	20 (10 pr.)
19290	3/4" (20mm)	1-7/32"	10 (5 pr.)
19291	1" (25mm)	1-17/32"	10 (5 pr.)



External Lock Washers

Zinc

Auveco Part No.	Bolt Size	O.D.	Unit Pkg.
5249	#4 (3/32")	1/4"	100
5250	#6 (1/8")	5/16"	100
5251	#8 (5/32")	3/8"	100
5252	#10 (3/16")	3/8"	100
5253	#12 (7/32")	15/32"	100
5254	#14 (1/4")	1/2"	100
5255	5/16"	19/32"	100
5256	3/8"	11/16"	100
5257	7/16"	3/4"	100
5258	1/2"	7/8"	100
16676	5/8"	1-1/32"	50



Countersunk External Lock Washers

Zinc

Auveco Part No.	Bolt Size	O.D.	Unit Pkg.
5270	#6 (1/8")	9/32"	100
5271	#8 (5/32")	5/16"	100
5272	#10 (3/16")	11/32"	100
24001	#12	0.421"	100
5274	#14 (1/4")	7/16"	100
24002	5/16"	0.599"	100
24003	3/8"	0.765"	100



Internal Lock Washers

Zinc

Auveco Part No.	Bolt Size	O.D.	Unit Pkg.
5259	#4 (3/32")	1/4"	100
5260	#6 (1/8")	9/32"	100
5261	#8 (5/32")	5/16"	100
5262	#10 (3/16")	3/8"	100
5263	#12 (7/32")	13/32"	100
5264	#14 (1/4")	15/32"	100
5265	5/16"	19/32"	100
5266	3/8"	11/16"	100
5267	7/16"	25/32"	100
5268	1/2"	7/8"	100
16673	3/4"	1-7/32"	50



**Internal-External
Combination
Lock Washers**
Zinc

Auveco Part No.	Bolt Size	O.D.	Unit Pkg.
17018	#8 (5/32")	1/2"	100
17019	#10 (3/16")	9/16"	100
17020	#14 (1/4")	23/32"	100
17021	5/16"	7/8"	100
17022	3/8"	31/32"	100
17023	7/16"	1-1/32"	50



**Natural Nylon Flat
Washers**

Auveco Part No.	Bolt Size	I.D. + .015	O.D. + .015	Thick. + .010	Unit Pkg.
13888	1/16"	.115"	.250"	.032"	100
13891	1/16"	.140"	.312"	.062"	100
13892	1/8"	.171"	.375"	.032"	100
13893	1/8"	.171"	.375"	.062"	100
13903	1/8"	.187"	.625"	.062"	50
13894	1/8"	.194"	.375"	.032"	100
13895	1/8"	.194"	.375"	.062"	100
13897	1/8"	.200"	.437"	.062"	100
13896	3/16"	.242"	.375"	.062"	100
13898	3/16"	.257"	.500"	.062"	100
13912	3/16"	.257"	.875"	.062"	50
13905	3/16"	.260"	.687"	.060"	50
13902	3/16"	.260"	.562"	.062"	100
13899	1/4"	.281"	.500"	.030"	100
13900	1/4"	.317"	.500"	.062"	100
13908	1/4"	.317"	.750"	.062"	50
24063	1/4"	0.260"	0.687"	0.040"	50
13913	5/16"	.343"	.885"	.062"	50
13904	5/16"	.380"	.625"	.062"	50
13909	5/16"	.390"	.750"	.062"	50
13918	5/16"	.390"	1.260"	.062"	25
13914	3/8"	.406"	1.000"	.062"	25
13906	3/8"	.421"	.687"	.062"	50
13910	3/8"	.443"	.750"	.062"	50
13919	7/16"	.500"	1.375"	.062"	25
13911	7/16"	.505"	.750"	.062"	50
13916	7/16"	.516"	1.250"	.062"	25
13920	7/16"	.525"	1.375"	.125"	25
13907	1/2"	.568"	.687"	.062"	50
13921	5/8"	.665"	1.500"	.094"	25

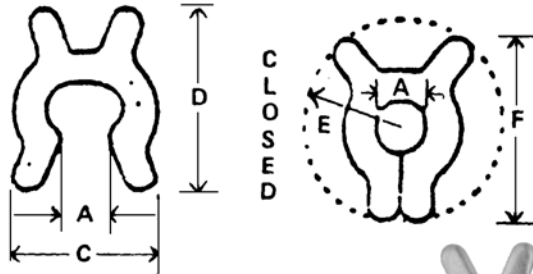

X-Washers
Zinc

Auveco Part No.	Material Thickness	A	C	D	E	F	Unit Pkg.
13691	.025	.086	.320	.406	.210	.406	50
13692	.055	.098	.364	.490	.297	.475	50
13693	.055	.130	.438	.576	.338	.558	50
13694	.065	.164	.523	.687	.422	.665	50
13696	.075	.222	.622	.776	.469	.775	25
13697	.075	.256	.698	.905	.500	.890	25
13698	.075	.285	.822	.986	.563	.984	25

Commercial tolerances all X-Washers

Illustrations actual size

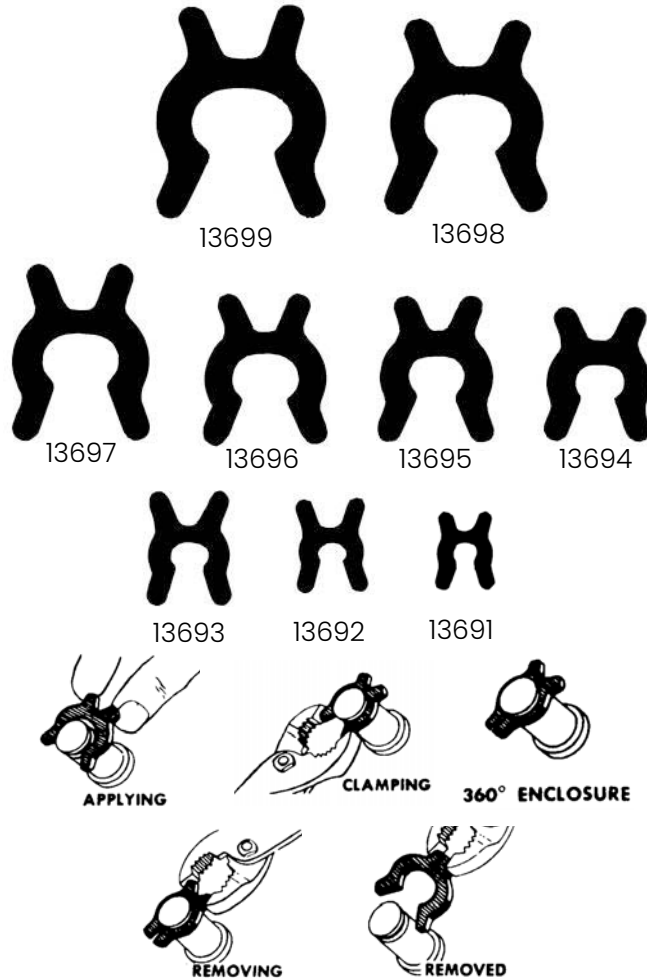



1-1/4" x 1-1/8"
Slot: 3/8"
Zinc

3155
Thick: 1/16"
UNIT PKG: 100

3156
Thick: 1/8"
UNIT PKG: 100



2" x 1-1/2"
Slot: 3/4"
Zinc

3000
Thick: 1/8"
UNIT PKG: 50



1-3/8" x 1-1/4"
Slot: 5/8"
Zinc

20322
Thick: 1/8"
UNIT PKG: 50



1-3/4" x 1-1/4"
Slot: 1/2"
Zinc

2452
Thick: 1/16"
UNIT PKG: 50

2453
Thick: 1/8"
UNIT PKG: 50



2" x 1-1/2"
Slot: 5/8"
Zinc

2999
1/8" Thick
UNIT PKG: 50



Outer Diameter: 15/16"
Slot: 3/8"
Zinc

20448
Thick: 1/16"
UNIT PKG: 50

20449
Thick: 1/8"
UNIT PKG: 50



Universal Alignment Shim

1-3/16" x 1-15/32"
Slot: 5/8"
Zinc

11187
Thick: 1/32"
(10 Gauge Steel)
UNIT PACKAGE: 25



Caster and Camber and Ball Joints Ford

1-1/8" x 1-1/8"
Slot: 1/2"
Zinc

Auveco Part No.	Thickness	Unit Pkg.
5075	1/32"	50
5076	1/16"	50
5077	1/8"	50



Caster and Camber Shims Chevrolet and GMC Trucks

1-1/2" x 2-1/2"
Slot: 9/16"
Zinc

Auveco Part No.	Thickness	Unit Pkg.
5096	1/32"	50
5097	1/16"	50

Metric Basic Internal Retaining Rings

DIN 472 - 1300
 Groove Required in Bore
 Phosphate & Oil Finish

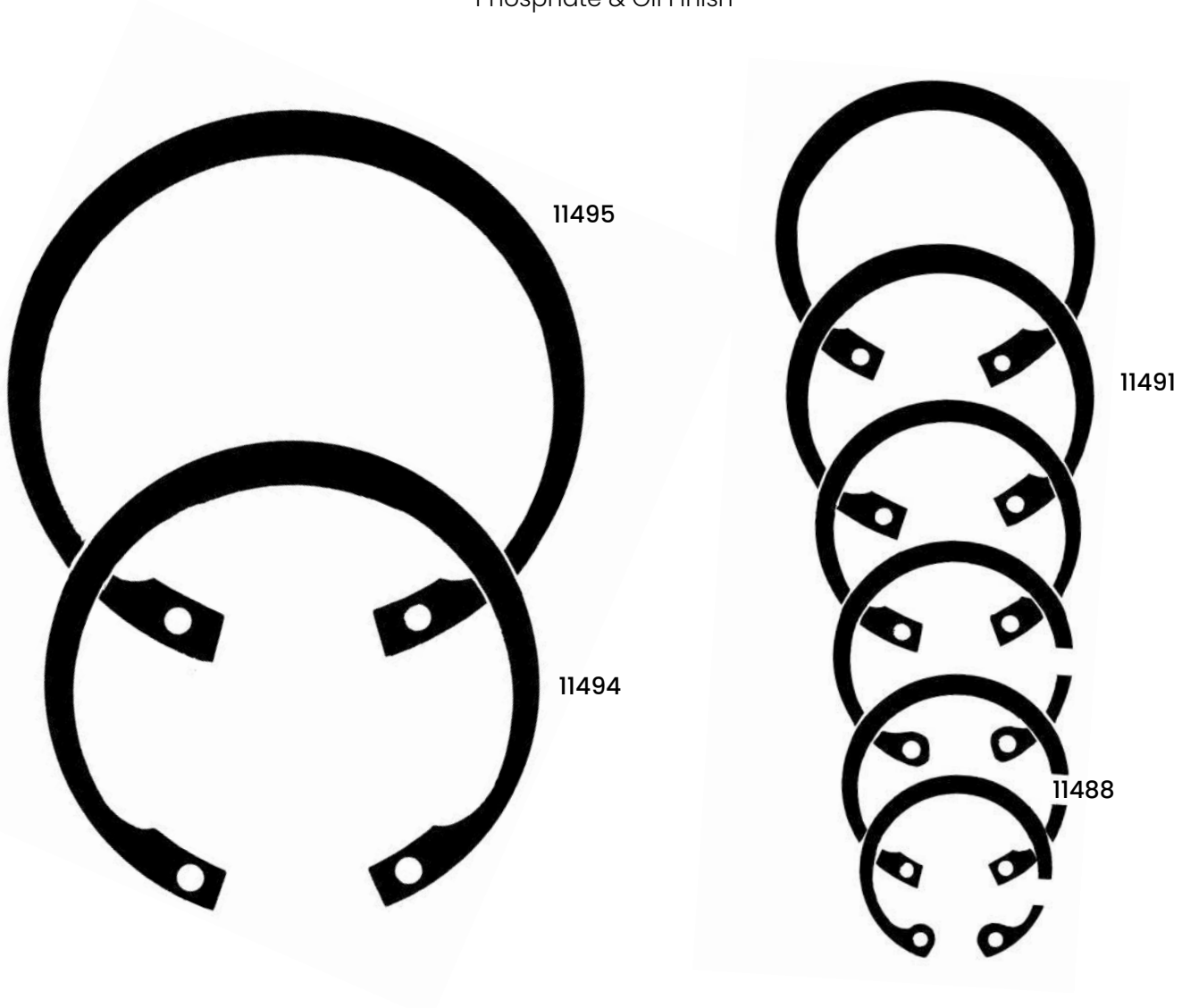

Auveco Part No.	Shaft Diameter		Groove Diameter		Groove Width		Unit Pkg.
	mm	Inches	mm	Inches	mm	Inches	
11488	30	1.181	31.4	1.237	1.30	.051	50
11491	40	1.575	42.5	1.675	1.85	.073	25
11494	52	2.047	55.0	2.165	2.15	.085	25
11495	62	2.441	65.0	2.559	2.15	.085	10

Metric Basic External Retaining Rings

DIN 471 - 1400

Groove Required on Shaft
Phosphate & Oil Finish

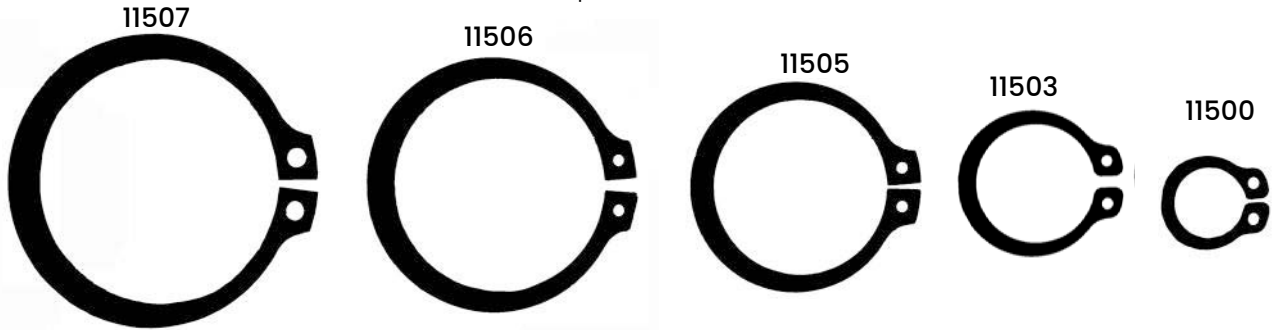

Auveco Part No.	Shaft Diameter		Groove Diameter		Groove Width		Unit Pkg.
	mm	Inches	mm	Inches	mm	Inches	
11500	10.0	.394	9.6	.378	1.10	.043	100
11503	17.0	.670	16.2	.637	1.10	.043	50
11505	25.0	.985	23.9	.941	1.30	.051	50
11506	30.0	1.182	28.6	1.126	1.60	.063	50
11507	35.0	1.378	33.0	1.299	1.60	.063	50

E Type Retaining Rings

DIN 6799 - 1500

Phosphate & Oil Finish



Auveco Part No.	Shaft Diameter		Groove Diameter		Groove Width		Unit Pkg.
	mm	Inches	mm	Inches	mm	Inches	
11514	2.0	.079	1.5	.059	0.44	.0173	100
11515	2.5	.098	1.9	.075	0.54	.0213	100
11516	3.0	.118	2.3	.091	0.64	.0252	100
11517	4.0	.157	3.2	.126	0.64	.0252	100
11518	5.0	.197	4.0	.157	0.74	.0291	100
11519	6.0	.236	5.0	.197	0.74	.0291	100
11520	7.0	.276	6.0	.236	0.74	.0291	100
11521	8.0	.315	7.0	.276	0.94	.0370	100
11523	10.0	.394	9.0	.354	1.15	.0453	100
11527	20.0	.787	19.0	.748	1.85	.0728	50

Internal Self-Locking Retaining Rings



No Groove Required
Bright Zinc

Auveco Part No.	Shaft Diameter	Unit Pkg.
8715	3/16" - (.184 to .192 Shaft)	100

External Grip Rings

No Groove Required
Bright Zinc

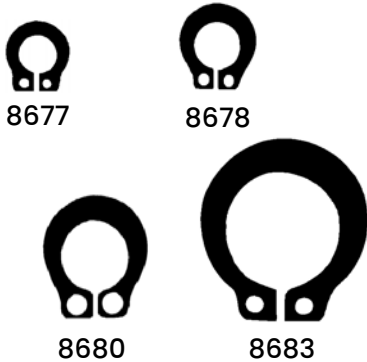

Auveco Part No.	Shaft Diameter	Unit Pkg.
8677	3/16" - (.185 to .189 Shaft)	50
8678	1/4" - (.248 to .252 Shaft)	50
8680	3/8" - (.373 to .379 Shaft)	50
8683	5/8" - (.622 to .628 Shaft)	50

Basic Internal Retaining Rings

Groove Required on Shaft
Bright Zinc

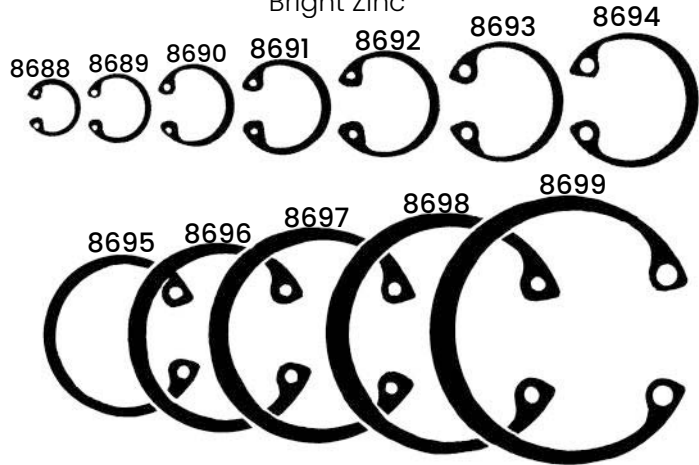

Auveco Part No.	Housing Dia.	Groove Dia.	Groove Width	Unit Pkg.
8688	1/4"	.268"	.020"	50
8689	5/16"	.330"	.020"	50
8690	3/8"	.397"	.029"	50
8691	7/16"	.461"	.029"	50
8692	1/2"	.530"	.039"	50
8693	9/16"	.596"	.039"	50
8694	5/8"	.665"	.039"	50
24070	11/16"	.732"	.039"	50
8695	3/4"	.796"	.039"	50
8696	7/8"	.931"	.046"	50
8697	1"	1.066"	.046"	50
24072	1-1/16"	1.130"	.056"	50
8698	1-1/8"	1.197"	.056"	50
8699	1-1/4"	1.330"	.056"	50
24074	1-5/16"	1.396"	.056"	25
24075	1-3/8"	1.461"	.056"	25
24076	1-7/16"	1.528"	.056"	25
24077	1-1/2"	1.594"	.056"	25
24079	1-3/4"	1.858"	.068"	25

Basic External Retaining Rings

Groove Required on Shaft
Zinc

Actual Size Illustrations on next page

Auveco Part No.	Shaft Diameter	Groove Diameter	Groove Width	Unit Pkg.	Auveco Part No.	Shaft Diameter	Groove Diameter	Groove Width	Unit Pkg.
8701	1/4"	.230"	.029"	50	8710	1"	.940"	.046"	50
8702	5/16"	.290"	.029"	50	10123	1-1/16"	.998"	.056"	50
10117	11/32"	.321"	.029"	50	8711	1-1/8"	1.059"	.056"	50
8703	3/8"	.352"	.029"	50	10124	1-3/16"	1.118"	.056"	50
10118	13/32"	.382"	.029"	50	8712	1-1/4"	1.176"	.056"	50
8704	7/16"	.412"	.029"	50	16744	1-3/8"	1.291"	.056"	50
8705	1/2"	.468"	.039"	50	10125	1-1/2"	1.406"	.056"	25
8706	9/16"	.530"	.039"	50	16745	1-5/8"	1.529"	.068"	25
8707	5/8"	.588"	.039"	50	10126	1-3/4"	1.650"	.068"	25
10120	11/16"	.646"	.046"	50	16746	1-7/8"	1.769"	.068"	25
8708	3/4"	.704"	.046"	50	10127	2"	1.886"	.068"	10
10121	13/16"	.762"	.046"	50	10128	2-1/4"	2.120"	.086"	10
8709	7/8"	.821"	.046"	50	16748	2-3/8"	2.239"	.086"	10
10122	15/16"	.882"	.046"	50	10129	2-1/2"	2.360"	.086"	10

For an assortment of Basic Internal and External Retaining Rings see Kit No. 6116 and Large Drawer Assortment No. 6507

BASIC EXTERNAL RETAINING RINGS

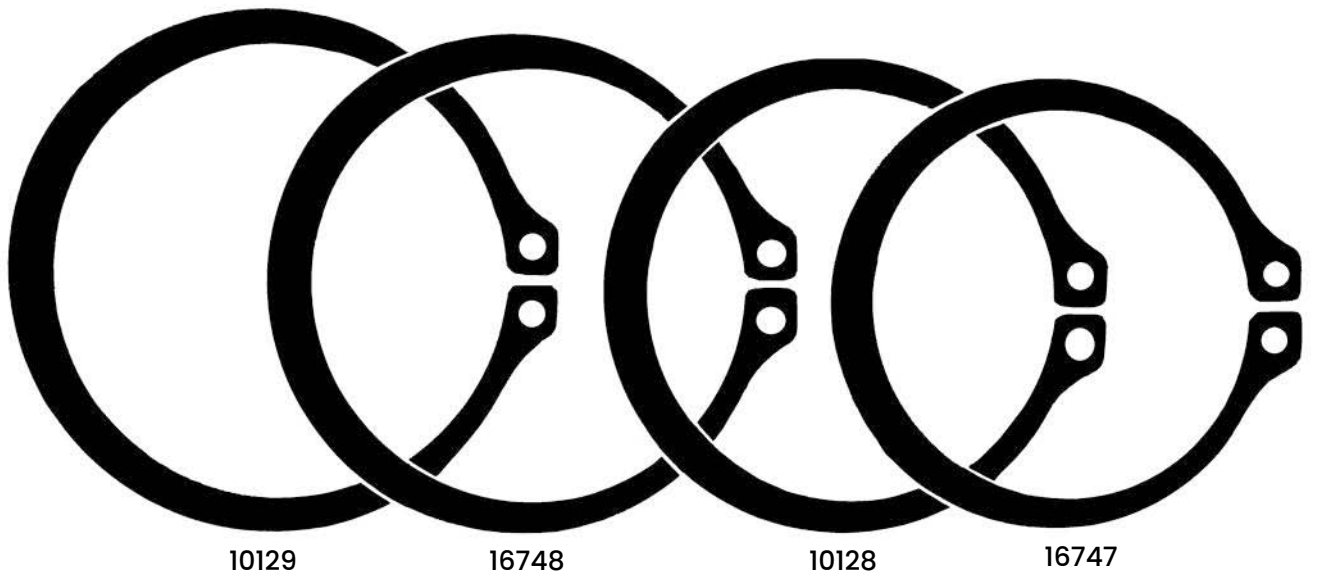
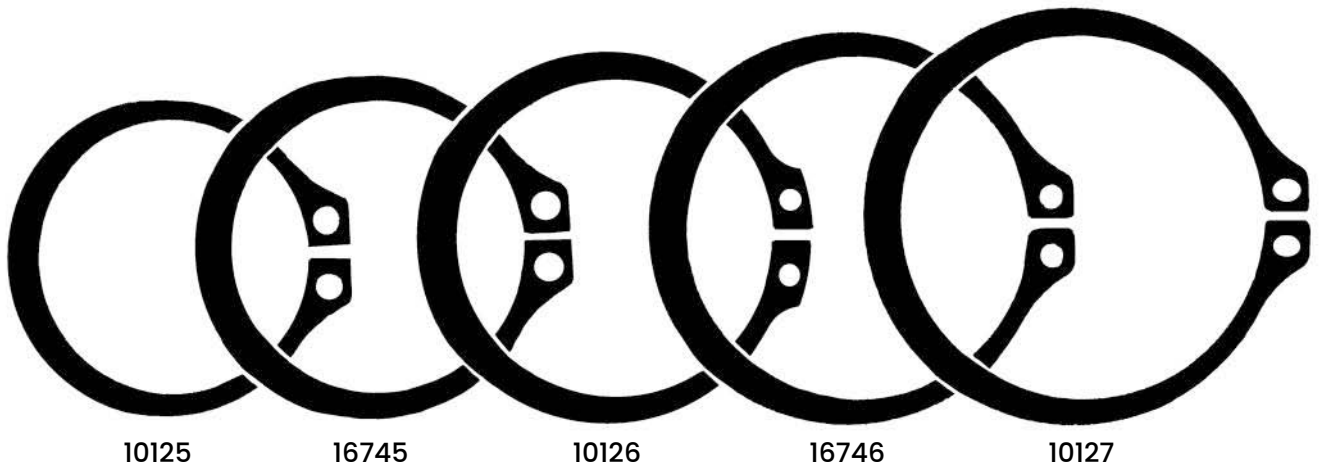
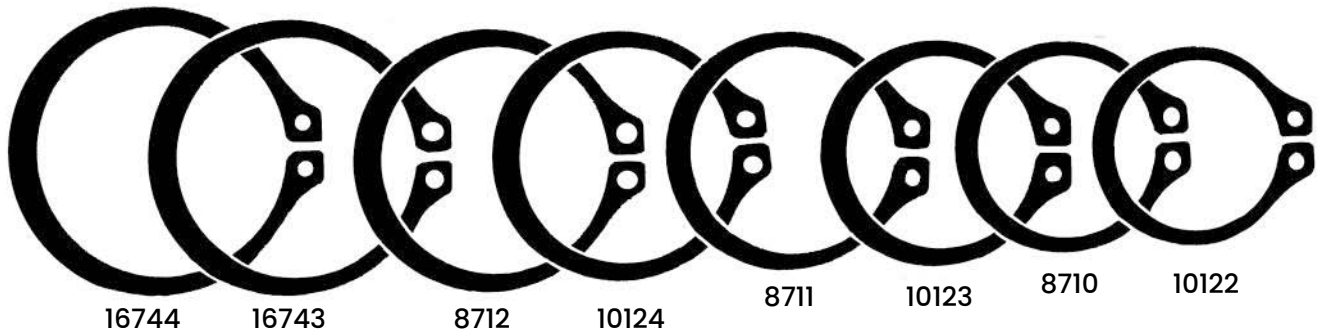
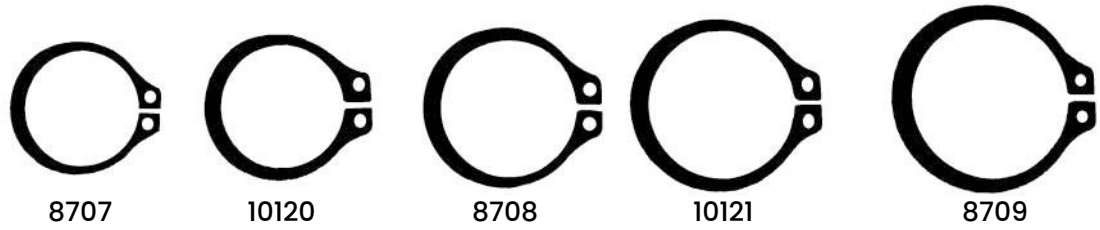
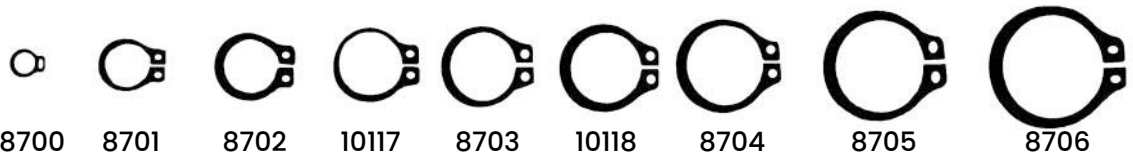

RETAINING RINGS

Reinforced E Type Retaining Rings

Auveco Part No.	Shaft Dia.	Groove Dia.	Groove Width	Unit Pkg.
8836	3/32"	.074"	.018"	100
3165	1/8"	.095"	.018"	100
10134	5/32"	.116"	.029"	100
3166	3/16"	.147"	.029"	100
10135	7/32"	.188"	.029"	100
3167	1/4"	.210"	.029"	100
3628	5/16"	.250"	.039"	100
5600	3/8"	.303"	.039"	100
2672	7/16"	.343"	.039"	100
8837	1/2"	.396"	.046"	100
5601	9/16"	.437"	.046"	100

E Type Retaining Rings

Phosphate & Oil

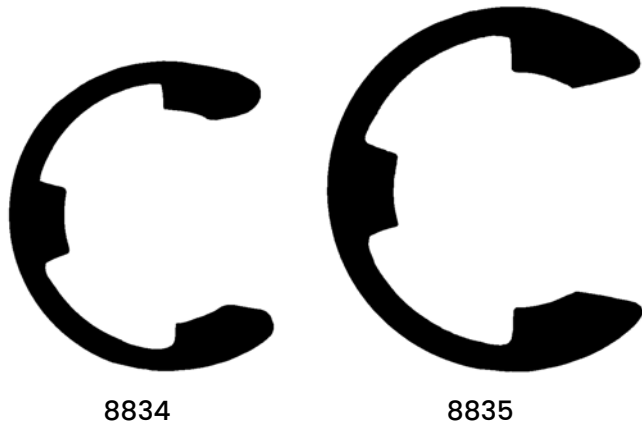
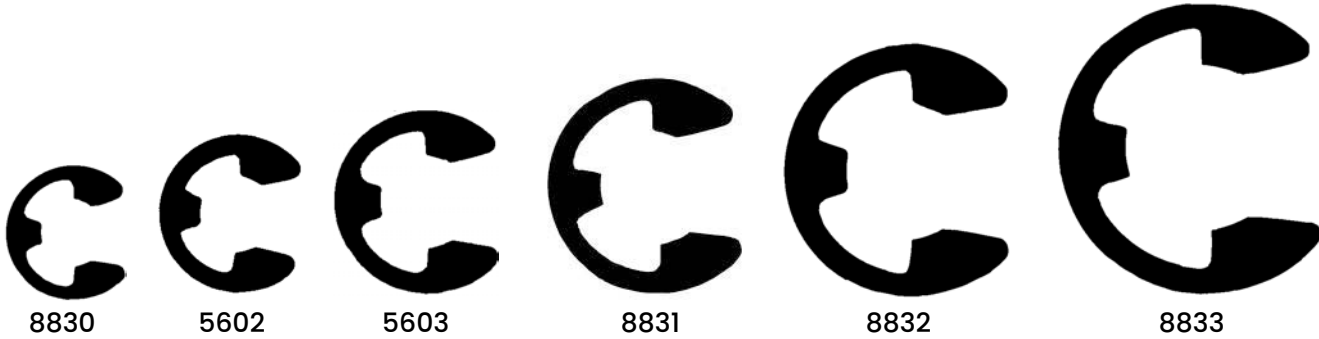
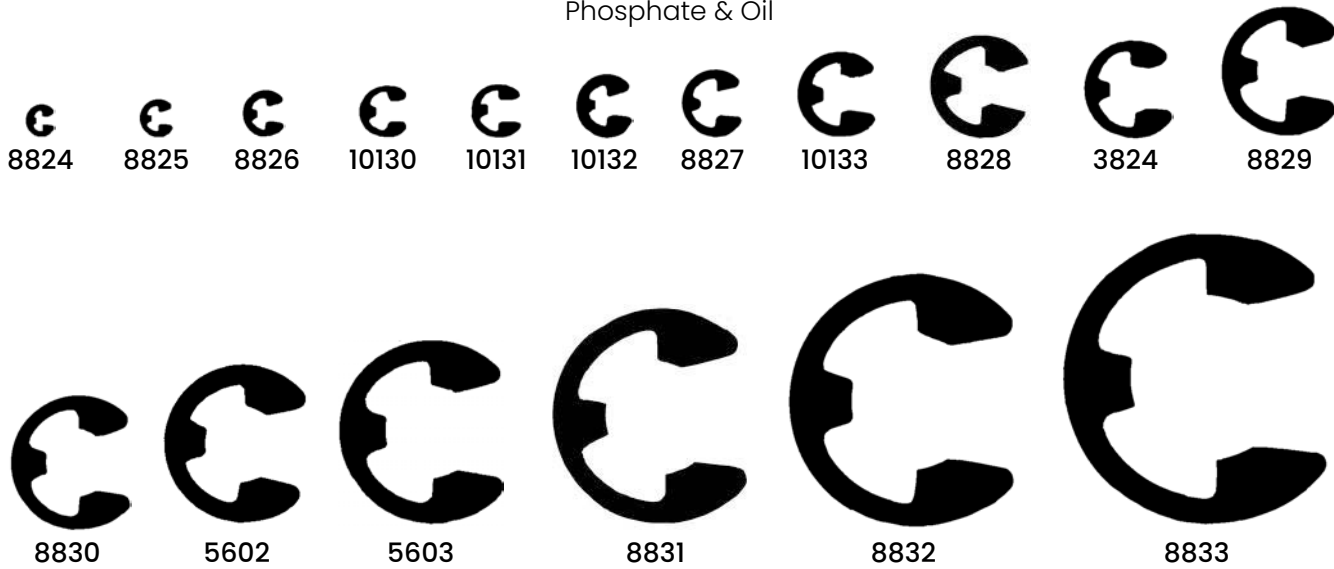

Auveco Part No.	Shaft Dia.	Groove Dia.	Groove Width	Unit Pkg.
8824	1/16"	.052"	.012"	100
8825	3/32"	.074"	.018"	100
8826	1/8"	.095"	.018"	100
10130	9/64"	.105"	.018"	100
10131	5/32"	.116"	.029"	100
10132	11/64"	.127"	.029"	100
8827	3/16"	.147"	.029"	100
10133	7/32"	.188"	.029"	100
8828	1/4"	.210"	.029"	100
3824	5/16"	.250"	.029"	100
8829	3/8"	.303"	.039"	100
8830	7/16"	.343"	.039"	100
5602	1/2"	.396"	.046"	100
5603	5/8"	.485"	.046"	100
8831	3/4"	.580"	.056"	50
8832	7/8"	.675"	.056"	50
8833	1"	.835"	.056"	50
8834	1-3/16"	1.079"	.068"	50
8835	1-3/8"	1.230"	.068"	50

For an assortment of E and Reinforced E Type Retaining Rings see Kit No. 6123 and Large Drawer 6508

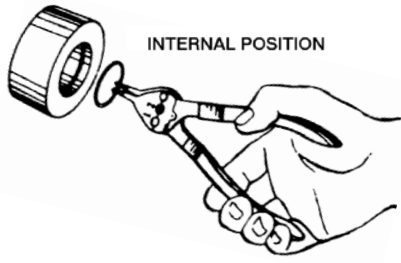

Convertible Retaining Ring Pliers

For Internal and External Retaining Rings

Illustrations and photos not actual size

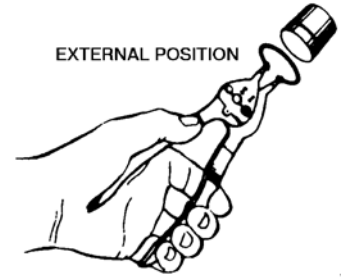

7910



Tip Diameter: .070"
 Use with Auveco Retaining Rings:
 8679 to 8633 (External)
 8698 & 8699 (Internal)
 8710 to 8712 (External)
 10122 to 10129 (External)
 16743 to 16748 (External)

UNIT PACKAGE: 1

SPRINGS

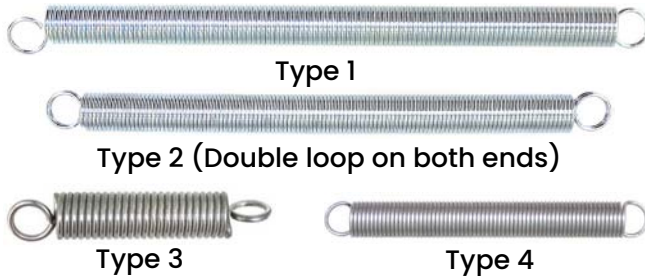

Extension Springs

Zinc
 Photos not actual size



Auveco Part No.	Unit Pkg.	Type	Length Overall	Coil Length	O.D.	Wire Size	Lbs Rate /Inch	Approx. Lbs Load at Reference Ext.
14060	5	1	6.500"	5.925"	.328"	.035"	7.5 oz.	2.2 @ 8.500"
14063	5	4	3.250"	2.750"	.375"	.041"	1.9	5.2 @ 5.250"
14065	5	3	4.500"	3.575"	.484"	.063"	6.2	14 @ 6.500"
14068	10	6	5.250"	3.000"	.531"	.062"	5.0	8.5 @ 6.250"
14070	5	5	2.656"	1.500"	.750"	.080"	10.3	12.5 @ 3.656"
14072	10	3	1.438"	.825"	.344"	.048"	15.0	10 @ 1.812"

SPRINGS, PINS & CLIPS

Universal Springs

Galvanized • Photos not actual size

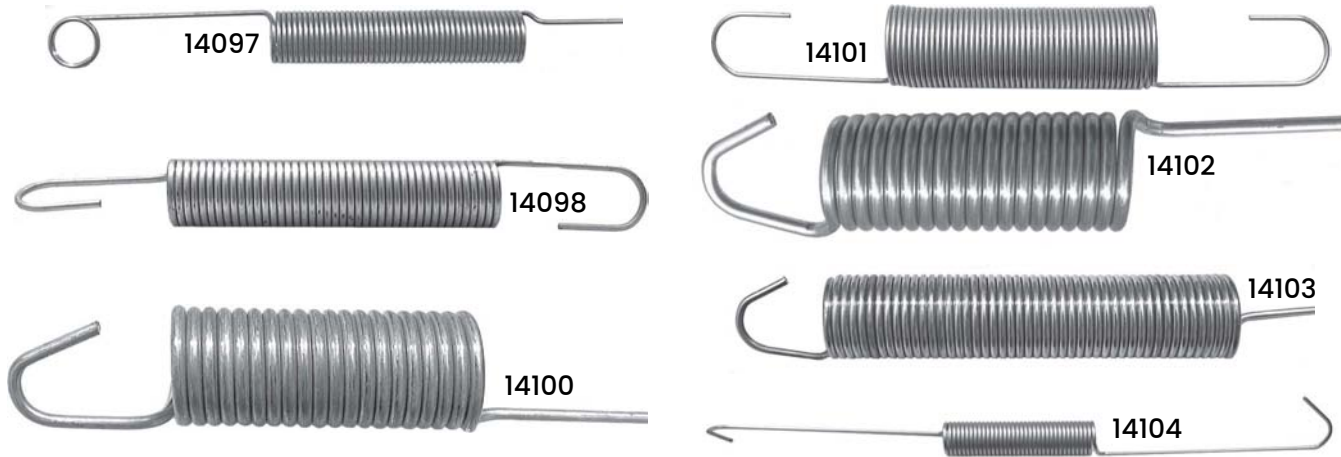

Auveco Part No.	Unit Pkg.	Length Overall	Coil Length	O.D.	Wire Size
14097	10	11-1/2"	1-7/8"	25/64"	1/32"
14098	10	4-3/8"	2-1/2"	1/2"	1/16"
14100	10	8-1/2"	1-7/8"	3/4"	3/32"
14101	10	5-3/4"	2-3/8"	25/32"	3/64"
14102	10	18-1/2"	2"	13/16"	3/32"
14103	10	17-1/2"	3-1/2"	3/4"	1/16"
14104	10	8-1/4"	2"	7/16"	1/16"



Compression Springs

Zinc

Auveco Part No.	Unit Pkg.	Length Overall	O.D.	Wire Size	Approx. Solid Ht.	Lbs. Rate /Inch
14089	20	2.193"	.590"	.040"	.380"	3.1
14094*	20	.781"	.375"	.042"	.378"	7.4
14095	10	2.625"	.438"	.048"	.950"	6.0

*Brass

Throttle Rod Clips

Black Phosphate



Left-hand Type



Right-hand

Type

Auveco Part No.	Rod Diameter	Ind. Std.	Type	Unit Pkg.
3609	5/32"	2	Right	100
3610	5/32"	2	Left	100
3611	3/16"	4	Right	100
3612	3/16"	4	Left	100
3613	1/4"	7	Right	100
3614	1/4"	7	Left	100

Retainer Pins

Zinc

Photo not actual size



Auveco Part No.	Inside Diameter	Overall Length	Wire Dia.	Unit Pkg.
9114	1/16"	3/8"	.035"	100
10390	7/64"	3/4"	.050"	100
9112	1/8"	1-1/8"	.070"	100
9110	3/16"	1-3/16"	.070"	100

Hair Pin Cotter

Zinc



16934

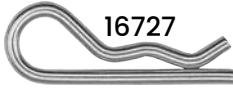

16727



24083

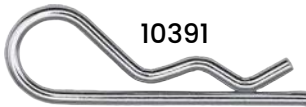

10391



11873

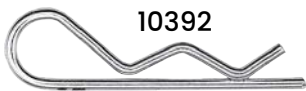

10392



10393

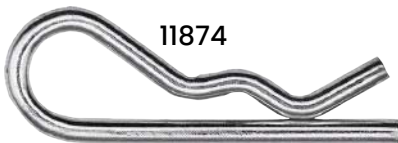

11874

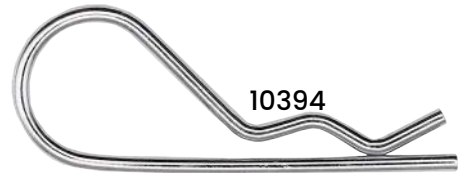

10394

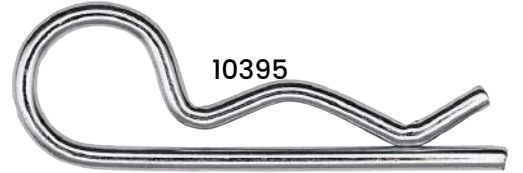

10395



10396

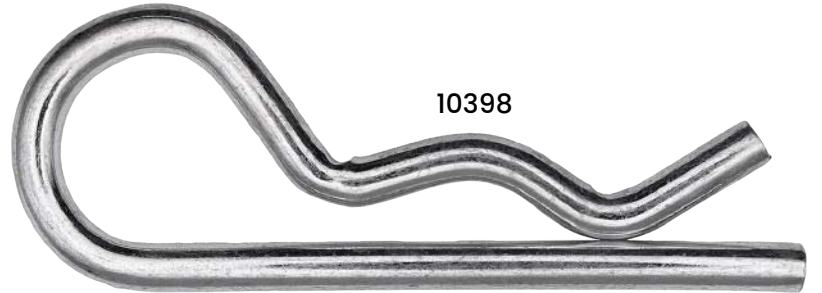

10398



10397

Auveco Part No.	Wire Dia.	Drill Hole Size	Min. Shaft Dia.	Max Shaft Dia.	Overall Length	Inside Dia. of Eye	Unit Pkg.
16934	.042" (3/64")	3/64"	3/16"	1/4"	1"	1/4"	100
16727	.080" (5/64")	3/32"	1/4"	3/8"	1-3/16"	1/4"	100
24083	.093"	7/64"	5/16"	1/2"	2"	5/8"	50
11872	.080" (5/64")	3/32"	3/8"	1/2"	1-9/16"	5/16"	100
11873	.062" (1/16")	5/64"	3/8"	1/2"	1-9/16"	5/16"	100
10392	.062" (1/16")	5/64"	3/8"	1/2"	1-9/16"	5/16"	100
10393	.125" (1/8")	9/64"	1/2"	3/4"	1-15/16"	7/16"	50
11874	.125" (1/8")	9/64"	1/2"	3/4"	1-15/16"	7/16"	50
10394	.093" (3/32")	7/64"	1/4"	5/8"	2-5/16"	5/8"	50
10395	.125" (1/8")	9/64"	5/8"	7/8"	2-1/2"	1/2"	25
10396	.177" (3/16")	3/16"	7/8"	1-1/4"	3-3/4"	7/8"	10
10398	.243" (1/4")	17/64"	3/4"	1"	4"	15/16"	10
10397	.310" (5/16")	21/64"	7/8"	1"	3-15/16"	7/8"	5

Hair Pin Cotters



3168



9890



2598



9892

Auveco Part No.	Inside Diameter	Overall Length	Wire Diameter	Unit Pkg.
24017	1/16"	9/32"	0.028"	100
3168	1/16"	23/64"	.025"	200
9890	3/32"	3/8"	.025"	100
24018	3/32"	15/32"	0.026"	100
2598	7/32"	3/4"	.060"	100



Lynch Pins

Auveco Part No.	Pin Size	Ring I.D.	Ring O.D.	Unit Pkg.
11733	7/16" O.D. x 2-1/2" Long Black Powder Coated	1-7/8"	2-1/4"	5
11736	1/4" O.D. x 2-1/8" Long Zinc Plated	1-5/8"	1-7/8"	10



**Clevis Pins
Drilled for
Cotter Pins**

Zinc

Auveco Part No.	Dia.	Use Pin Dia.	Length Under Head to Ctr of Hole	Length Under Head to End of Pin
9433	1/4"	1/16"	29/32"	1"
9435	5/16"	3/32"	7/8"	1"
9438	5/16"	3/32"	1-1/4"	1-3/8"
9441	3/8"	3/32"	1"	1-1/8"
9443	3/8"	3/32"	1-1/8"	1-1/4"
9444	3/8"	3/32"	1-3/8"	1-1/2"
9446	1/2"	1/8"	1-11/32"	1-1/2"
9447	1/2"	1/8"	1-19/32"	1-3/4"

UNIT PACKAGE: 25

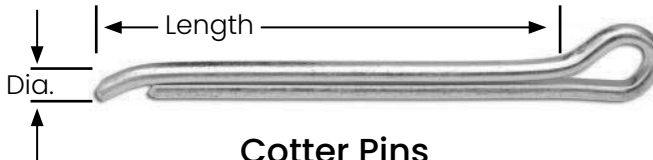

**Cotter Pins
Hammer-Lock Type**

C 1008 Steel

Auveco Part No. Plated	Auveco Part No. Plain	Size	Unit Pkg.
8477		1/16" x 1/2"	200
8478		1/16" x 3/4"	200
8479		1/16" x 1"	200
8480		1/16" x 1-1/2"	200
14903		3/32" x 1/2"	200
8481		3/32" x 3/4"	200
8482	3511	3/32" x 1"	200
8483	3512	3/32" x 1-1/4"	200
8484	3513	3/32" x 1-1/2"	200
8485	3515	3/32" x 2"	200
8486	3520	1/8" x 1"	200
8487	3521	1/8" x 1-1/4"	200
8488	3522	1/8" x 1-1/2"	200
8489		1/8" x 1-3/4"	200
8490	3524	1/8" x 2"	200
8491		1/8" x 2-1/2"	200
8492		5/32" x 1"	100
14905	8506	5/32" x 1-1/4"	100
8493	8507	5/32" x 1-1/2"	100
8494		5/32" x 2"	100
14907		5/32" x 2-1/2"	100
14908		5/32" x 3"	100
8495		3/16" x 1-1/2"	100
8496		3/16" x 2"	100
8497		3/16" x 2-1/2"	100
14911		3/16" x 3"	100
8499		1/4" x 2"	100
8500		1/4" x 2-1/2"	100
8501		1/4" x 3"	100
14912		1/4" x 4"	100
8502		5/16" x 2-1/2"	50

For assortments of Cotter Pins see Large Drawer (6500 Series) No. 6506



Spring Pins

Zinc

Auveco Part No.	Dia.	Length	Wall Thick.	Unit Pkg.	Auveco Part No.	Dia.	Length	Wall Thick.	Unit Pkg.
8981	1/16"	3/16"	.012"	50	9019	3/16"	1/2"	.040"	50
8983	1/16"	1/2"	.012"	50	9021	3/16"	3/4"	.040"	50
8985	1/16"	3/4"	.012"	50	9022	3/16"	1"	.040"	50
8987	1/16"	1"	.012"	50	9023	3/16"	1-1/4"	.040"	50
8988	5/64"	1/4"	.018"	50	9024	3/16"	1-1/2"	.040"	50
8989	5/64"	1/2"	.018"	50	9025	3/16"	1-3/4"	.040"	50
8991	5/64"	3/4"	.018"	50	9026	3/16"	2"	.040"	50
8992	5/64"	1"	.018"	50	9027	7/32"	5/8"	.048"	50
8993	5/64"	1-1/4"	.018"	50	9028	7/32"	1-3/8"	.048"	50
8994	5/64"	1-1/2"	.018"	50	9029	7/32"	1-3/4"	.048"	50
8995	3/32"	5/16"	.022"	50	9030	1/4"	5/8"	.050"	50
8996	3/32"	1/2"	.022"	50	9031	1/4"	3/4"	.050"	50
8997	3/32"	5/8"	.022"	50	9033	1/4"	1"	.050"	50
8998	3/32"	3/4"	.022"	50	9034	1/4"	1-1/4"	.050"	50
9000	3/32"	1"	.022"	50	9035	1/4"	1-1/2"	.050"	50
9001	3/32"	1-1/4"	.022"	50	9036	1/4"	1-3/4"	.050"	50
9002	3/32"	1-1/2"	.022"	50	9037	1/4"	2"	.050"	50
9004	1/8"	1/2"	.028"	50	9038	1/4"	2-1/4"	.050"	50
9005	1/8"	5/8"	.028"	50	9039	1/4"	2-1/2"	.050"	50
9006	1/8"	3/4"	.028"	50	9040	5/16"	3/4"	.062"	50
9007	1/8"	7/8"	.028"	50	9042	5/16"	1"	.062"	50
9008	1/8"	1"	.028"	50	9043	5/16"	1-1/2"	.062"	50
9009	1/8"	1-1/4"	.028"	50	9044	5/16"	1-3/4"	.062"	25
9010	1/8"	1-1/2"	.028"	50	9045	5/16"	2"	.062"	25
9011	1/8"	1-3/4"	.028"	50	9046	5/16"	2-1/2"	.062"	25
9012	1/8"	2"	.028"	50	9048	3/8"	1"	.077"	25
9013	5/32"	1/2"	.032"	50	9049	3/8"	1-1/2"	.077"	25
9015	5/32"	3/4"	.032"	50	9050	3/8"	2"	.077"	25
9016	5/32"	1"	.032"	50	9051	3/8"	2-1/2"	.077"	25
9017	5/32"	1-1/4"	.032"	50					
9018	5/32"	1-1/2"	.032"	50					

Yoke Ends

Drop Forged • Adjustable • Zinc Finish

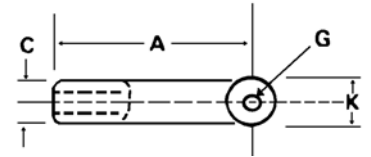
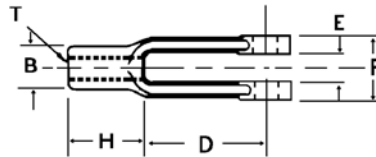
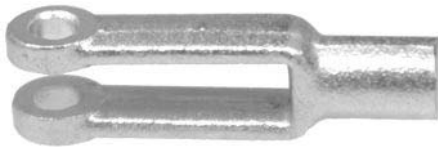

Auveco Part No.	"T" Tap Size	A	B	C	D	E	F	G	H	K	Unit Pkg.
10737	1/4"-28	2"	7/16"	7/16"	1-1/4"	9/32"	5/8"	1/4"	3/4"	1/2"	10
10788	1/4"-28	2"	7/16"	7/16"	1-1/4"	9/32"	5/8"	1/4"	3/4"	1/2"	2
10738	5/16"-24	2-1/4"	1/2"	1/2"	1-7/16"	11/32"	3/4"	5/16"	13/16"	19/32"	10
10789	5/16"-24	2-1/4"	1/2"	1/2"	1-7/16"	11/32"	3/4"	5/16"	13/16"	19/32"	2
10739	3/8"-24	2-1/2"	5/8"	5/8"	1-5/8"	7/16"	7/8"	3/8"	7/8"	11/16"	10
10790	3/8"-24	2-1/2"	5/8"	5/8"	1-5/8"	7/16"	7/8"	3/8"	7/8"	11/16"	2
10740	7/16"-20	2-7/8"	23/32"	23/32"	1-7/8"	1/2"	1"	7/16"	1"	13/16"	10
10791	7/16"-20	2-7/8"	23/32"	23/32"	1-7/8"	1/2"	1"	7/16"	1"	13/16"	2
10741	1/2"-20	3"	13/16"	13/16"	1-7/8"	9/16"	1-1/8"	1/2"	1-1/8"	15/16"	10
10792	1/2"-20	3"	13/16"	13/16"	1-7/8"	9/16"	1-1/8"	1/2"	1-1/8"	15/16"	2
10742	5/8"-18	4-15/16"	1-1/16"	1-1/16"	3-11/16"	11/16"	1-3/8"	5/8"	1-1/4"	1-3/16"	10
10793	5/8"-18	4-15/16"	1-1/16"	1-1/16"	3-11/16"	11/16"	1-3/8"	5/8"	1-1/4"	1-3/16"	2

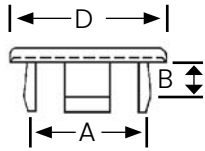

Nylon Hole Plug

Nylon 6/6 • Matte Finish



Auveco Part No.	Hole Size (A)	Panel Thickness (B)	Head Size (D)	Head Height	Color	Unit Pkg.
13865	1/4"	1/32"-1/16"	27/64"	.040"	Black	100
13869	3/8"	1/32"-9/64"	37/64"	.050"	Black	100
13873	1/2"	1/32"-9/64"	43/64"	.062"	Black	50
13875	9/16"	1/32"-9/64"	47/64"	.062"	Black	50
13877	5/8"	1/32"-5/64"	51/64"	.062"	Black	50
13879	11/16"	1/32"-7/64"	57/64"	.062"	Black	50
13881	3/4"	1/32"-7/64"	63/64"	.062"	Black	50
13885	7/8"	1/32"-7/64"	1-5/64"	.062"	Black	50
13887	1"	1/32"-7/64"	1-7/32"	.062"	Black	50



Plastic Plug Buttons

Depressed Center
Black Polyethylene

Auveco Part No.	Hole Size	Head Dia.	Working Thickness	Unit Pkg.
9288	1/2"	7/8"	.02 -.07"	100
9289	3/4"	1-5/32"	.02 -.14"	100
9290	7/8"	1-1/4"	.02 -.10"	100
9291	1"	1-3/8"	.04 -.10"	100
9292	1-1/4"	1-5/8"	.04 -.10"	100
9293	1-1/2"	1-7/8"	.04 -.10"	100
17207	1-3/4"	2-1/8"	.15 -.17"	50
17208	2"	2-3/8"	.17 -.19"	50
18798	2-1/2"	3"	.15 -.17"	25
18799	3"	3-1/2"	.18 -.20"	10



Flush Sheet Metal Plugs

Fits 14 to 26 Gauge Material
Black Polyethylene

Auveco Part No.	Hole Size	Head Dia.	Unit Pkg.
14923	3/8"	3/4"	100
11746	1/2"	7/8"	100
18750	5/8"	1-3/64"	100
23883	11/16"	1"	100
11747	3/4"	1"	100
11748	7/8"	1-5/32"	100
11749	1"	1-7/16"	100
18800	1-1/4"	1-5/8"	50
18801	1-1/2"	1-7/8"	25
18802	1-3/4"	2-1/8"	25
18803	2"	2-7/16"	10
18804	2-1/2"	3"	10
18806	3"	3-3/8"	5



Plug Buttons

Nickel Plated

Auveco Part No.	Hole Size	Head Dia.	Working Thickness	Unit Pkg.
3750	1/4"	13/32"	.035" -.062"	50
3751	3/8"	1/2"	.037" -.078"	50
3752	1/2"	21/32"	.037" -.062"	50
3753*	5/8"	13/16"	.062" -.078"	50
3754	3/4"	15/16"	.037" -.093"	50
3755*	7/8"	1-1/16"	.031" -.093"	50
3756*	1"	1-1/8"	.062" -.093"	50
24044	1"	1-9/64"	3/32-1/8"	50
10231	1-1/4"	1-7/16"	.062" -.093"	10
10232	1-1/2"	1-21/32"	.038" -.141"	10

* Stainless Steel

WARNING: Reproductive Risk & Cancer - www.P65Warnings.ca.gov



Nylon Flush Hole Plugs

Auveco Part No.	Hole Size	Head Dia.	Unit Pkg.
23976	1/8"	13/64"	100

BLACK NYLON LOCKING HOLE PLUGS



These hole plugs are designed with multiple locks to positively snap into panel thicknesses ranging from 1/64" to 1/8". Excellent for paintless dent repair. Made of heat stabilized nylon and suitable for elevated temperatures.

Auveco Part No.	Panel Hole Diameter	Maximum Panel Thickness	Plug Dimensions		Unit Pkg.
			Head Diameter	Thickness	
19764	3/16"	1/16"	1/4"	15/64"	100
18900	1/4"	1/16"	5/16"	5/16"	50
19765	5/16"	1/16"	3/8"	5/16"	50
18901	3/8"	1/8"	15/32"	13/32"	50
19766	7/16"	1/8"	17/32"	13/32"	50
18902	1/2"	1/8"	37/64"	13/32"	50
19767	9/16"	1/8"	21/32"	13/32"	50
18903	5/8"	1/8"	23/32"	13/32"	50
18904	3/4"	1/8"	59/64"	13/32"	50
19769	13/16"	1/8"	57/64"	13/32"	50
18905	7/8"	1/8"	1-1/64"	29/64"	50
18906	1"	1/8"	1-13/64"	29/64"	50
19770	1-3/32"	1/8"	1-7/32"	29/64"	50
19771	1-3/16"	1/8"	1-5/16"	29/64"	50
18907	1-1/4"	1/8"	1-3/8"	29/64"	50
19772	1-3/8"	1/8"	1-1/2"	29/64"	25
18908	1-1/2"	1/8"	1-43/64"	29/64"	25
18910	2"	1/8"	2-9/64"	29/64"	25

KEYS

Woodruff Keys

1035 Carbon Steel • Plain

Auveco Part No.	Size	Unit Pkg.	Auveco Part No.	Size	Unit Pkg.
3877	(No. 3) 1/8" x 1/2"	100	3887	(No. 16) 3/16" x 1-1/8"	50
3878	(No. 5) 1/8" x 5/8"	100	3888	(No. 12) 7/32" x 7/8"	50
3879	(No. 7) 1/8" x 3/4"	100	3889	(No. 14) 7/32" x 1"	50
3880	(No. 4) 3/32" x 5/8"	100	3890	(No. 17) 7/32" x 1-1/8"	50
3881	(No. 6) 5/32" x 5/8"	100	3891	(No. A) 1/4" x 7/8"	50
3882	(No. 8) 5/32" x 3/4"	100	3892	(No. 15) 1/4" x 1"	50
3883	(No. 10) 5/32" x 7/8"	100	3894	(No. 21) 1/4" x 1-1/4"	50
3884	(No. 9) 3/16" x 3/4"	100	3895	(No. B) 5/16" x 1"	50
3885	(No. 11) 3/16" x 7/8"	100	3896	(No. C) 5/16" x 1-1/8"	50
3886	(No. 13) 3/16" x 1"	50			

Straight Keys

Plain



Auveco Part No.	Size	Unit Pkg.
Long Lengths		
9794	3/16" x 3/16" x 12"	5
9795	1/4" x 1/4" x 12"	5
9796	5/16" x 5/16" x 12"	5
9800	3/8" x 3/8" x 12"	5
9801	7/16" x 7/16" x 12"	5
9802	1/2" x 1/2" x 12"	5

Vinyl Vacuum Caps

Can be used for capping lines and hoses while testing carburetors, emission control systems, vacuum lines, etc.
Color coded for size identification.



Auveco Part No.	I.D.	Fits Tube O.D.	Color	Length	Unit Pkg.
18202	1/8"	3/16"	Blue	5/8"	50
18203	3/16"	1/4"	Red	5/8"	50
18204	1/4"	5/16"	White	5/8"	50
18205	5/16"	3/8"	Black	5/8"	50



Rubber Caps

Special Heat Resistant EPDM Rubber

Ford - GM - Chrysler

Can be used for capping lines and hoses while testing carburetors, emission control systems, vacuum lines, etc

Auveco Part No.	Fits Tube O.D.	Inside Length	Unit Pkg.
12209	1/8"	9/16"	25
4440	3/16"	9/16"	25
19000	3/16"	1-1/4"	25
4439	1/4"	9/16"	25
19001	1/4"	1-1/4"	25
25309	9/32"	3/4"	25
19002	5/16"	9/16"	25
12907	5/16"	1-1/4"	25
12210	3/8"	31/32"	25
19003	3/8"	1-1/2"	25
12908	1/2"	11/16"	10



23712

Heater by Pass Cap
Hose Size: 5/8"
All Cars and Trucks

UNIT PACKAGE 100



23714

Heater by Pass Cap
Hose Size: 3/4"
All Cars and Trucks

UNIT PACKAGE 100

NYLON CONNECTORS



12929

1/8" x 1/8"
Connector

UNIT PACKAGE: 10



12930

1/8" x 3/16"
Connector

UNIT PACKAGE: 10



12936

1/8" x 1/4"
Connector

UNIT PACKAGE: 10



12937

3/16" x 3/16"
Connector

UNIT PACKAGE: 10



12935

3/16" x 1/4"
Connector

UNIT PACKAGE: 10



12931

1/4" x 1/4"
Connector

UNIT PACKAGE: 10



12946

5/16" x 5/16"
Connector

UNIT PACKAGE: 10



12938

3/8" x 1/4"
Connector

UNIT PACKAGE: 10



12934

3/8" x 3/8"
Connector
UNIT PACKAGE: 10



12923

1/8" All Ends
Tee

UNIT PACKAGE: 10

NYLON CONNECTORS



10697

1/8" All Ends
Tee

UNIT PACKAGE: 10



12916

1/8" x 3/16" x 1/8"
Tee

UNIT PACKAGE: 10



12924

1/8" x 3/16" x 3/16"
Tee

UNIT PACKAGE: 10



12926

3/16" x 3/16" x 1/8"
Tee

UNIT PACKAGE: 10

23391
Same as 12926
UNIT PACKAGE: 25



12917

1/8" x 1/8" x 1/4"
Tee

UNIT PACKAGE: 10



12918

3/16" All Ends
Tee

UNIT PACKAGE: 10



23299

3/16" x 3/16" x 3/16"
Tee

UNIT PACKAGE: 10



12919

1/4" x 3/16" x 3/16"
Tee

UNIT PACKAGE: 10



17629

1/4" All Ends
Tee

UNIT PACKAGE: 10



11738

1/4" x 1/4" x 3/16"
Tee

UNIT PACKAGE: 10



12921

3/8" x 3/8" x 1/4"
Tee

UNIT PACKAGE: 10



12922

1/4" x 3/8" x 3/8"
Tee

UNIT PACKAGE: 10



12920

5/16" All Ends
Tee

UNIT PACKAGE: 10



12925

3/8" All Ends
Tee
UNIT PACKAGE: 10



12927

3/16" All Ends
Y Connector
UNIT PACKAGE: 10



12943

1/4" All Ends
Y Connector

UNIT PACKAGE: 10



12944

5/16" All Ends
Y Connector

UNIT PACKAGE: 10



23862

3/8" x 3/8" x 3/8"
Y Connector

UNIT PACKAGE: 10



12933

1/4" x 1/4"
Elbow

UNIT PACKAGE: 10



12932

3/16" x 3/16"
Elbow

UNIT PACKAGE: 10



18836

(EIZE-9E499CA)
5/32" x 5/32" x 8/16"
Emission Harness
Elbow Connector
Ford

UNIT PACKAGE: 25



12948

3/16" x 1/4"
Elbow

UNIT PACKAGE: 10



12947

1/8" x 3/16"
Elbow

UNIT PACKAGE: 10



12940

3/16" All Ends
F Connector

UNIT PACKAGE: 10



12939

3/16" All Ends
Cross Connector

UNIT PACKAGE: 5



11419

3/16" All Ends
4 Way Connector

UNIT PACKAGE: 25



12949

3/16" All Ends
5 Way Tee

UNIT PACKAGE: 5



10368

Butyrate

3-Way Universal
For 1/8" 1/4" and 3/8" Tubing
Break-Off Tee

Not for use in Fuel Line

UNIT PACKAGE: 5

Photo not actual size

Nylon Connectors Cross Reference O.E.M. Number Chart

Auveco Part No.	OEM No.	Auveco Part No.	OEM No.	Auveco Part No.	OEM No.
11419	GM: 560692, 22508803	12924	GM: 14017780	12935	GM: 1621253, 472812
	Ford: 383847-S	12925	GM: 14023108 Ford: 388131-S		Ford: 800843
11738	GM: 3963228	12926	GM: 14031114		AMC: 3239826
12916	GM: 14025274, 14031144	12927	GM: 10003617, 22508052	12936	GM: 14017702
	Ford: 383016		Ford: 383031	12937	GM: 560625, 22508051
	Chry: 4241362		AMC: 3236813		Ford: 383003, 389138
12917	GM: 1610403	12928	GM: 14046514		Chry: 4104998
12918	GM: 357020, 272766, 22508050	12929	GM: 14047034 Ford: 383000 Chry: 4095145	12938	Ford: E0VE-9K319AB
	Ford: 373846-S	12930	GM: 14017701 Ford: 383001 Chry: 3441743, 4241296	12939	GM: 354400 Ford: 387042 Chry: 4241054
	Chry: 3671410			12940	GM: 14029095
	AMC: 3673945	12931	GM: 1614858, 14004876, 10017487	12941	GM: 14031149
12919	GM: 1617333, 10003294		Ford: 383005	12943	GM: 10004121 Chry: 4019472 AMC: 4006848
	Ford: 388034 12920	12932	GM: 556992, 14031145, 22508049	12944	Chry: 4179982
	GM: 6466355		Ford: 387065	12946	Chry: 4179981
	Chry: 4167810		Chry: 4100727	12947	GM: 14017779
12921	GM: 472814 Ford: D9AE-9E645AA	12933	Ford: 387074	12948	GM: 387980
12922	GM: 472815 Ford: 801471	12934	GM: 22505958 Chry: 4201198	12949	Ford: 384111 AMC: 3237451
12923	GM: 14017705 Ford: 3895904 Chry: 3751212				



Nylon Hose Connectors

Barbed on Both Ends

Auveco Part No.	Hose Size	Unit Pkg.
10101*	1/8" x 1/8"	10
10102	3/16" x 3/16"	10
10103	1/4" x 1/4"	10
10104	5/16" x 5/16"	10
10105	3/8" x 3/8"	10

*Single barb on each end



Nylon Reducer Connector

Barbed on Both Ends

Auveco Part No.	Hose Size	Unit Pkg.
10106	1/4" x 3/16"	10



Nylon Tubing & Hose Tee Connectors

Barbed on All Ends

Auveco Part No.	Hose Size I.D.	Unit Pkg.
10108	5/32" x 5/32" x 5/32"	10
10109	3/16" x 3/16" x 3/16"	10
10110	1/4" x 1/4" x 1/4"	10
14813	5/16" x 5/16" x 5/16"	10
11228	3/8" x 3/8" x 3/8"	10



11321 Butyrate

Universal Tubing Connector
For 1/8", 1/4" or 3/8"
For use with Vacuum and Windshield Washer Tubing
Not for use in Fuel Line

UNIT PACKAGE: 10

Sec. 11

AIRLINE COUPLINGS, AIR HOSE & TOOLS

Photos not actual size

210 Series: Push-to-connect, pin-type hose couplings designed for one-way shutoff in 1/4" capacity. **Average flow:** 18 cfm at 90 PSIG (6.2 bar) inlet and 10 PSIG (0.69 bar) pressure drop. Maximum inlet pressure: 250 PSIG (17 bar). Zinc chromate finish.



16045
1/4" Female NPT
UNIT PACKAGE: 5



16046
1/4" Male NPT
UNIT PACKAGE: 5



16049
1/4" Female NPT
UNIT PACKAGE: 5



16051
1/4" Male NPT
UNIT PACKAGE: 5

MS Series: For use with industrial interchange style connectors. Push-to-connect type designed for one-way shutoff in 1/4" capacity. **Average flow:** 36 cfm at 90 PSIG (6.2 bar) inlet and 10 PSIG (0.69 bar) pressure drop. Maximum inlet pressure: 250 PSIG (17 bar)..



16066
Brass
1/4" Female NPT
UNIT PKG: 5



16067
Brass
1/4" Male NPT
UNIT PKG: 5



16070
Zinc Chromate
1/4" Female NPT
UNIT PKG: 5



16071
Zinc Chromate
1/8" Male NPT
UNIT PKG: 5

⚠ WARNING: ALL AIRLINE COUPLINGS: Reproductive Risk & Cancer www.P65Warnings.ca.gov

Red Air Hose

Photo not actual size



Male Brass Fitting

Four spiral reinforced EPDM rubber construction offers superior durability and excellent flexibility. Limited oil resistance. Coupled with brass fittings. Maximum working pressure is 300 P.S.I.

Auveco Part No.	I.D.	Description	Unit Pkg.
Impact Tool Air Hose			
15539	3/8"	1/4" Male Pipe Thread Fittings	50' Roll

20900

Hose Cutter



Razor sharp blade cleanly cuts heater hoses, fuel line hoses and any other type of flexible hose up to 1-1/4" diameter.

The stainless steel blade is reversible for double the life.

The pliers are made of glass-filled gray nylon for strength. Includes a locking hoop for safe storage.

Overall length: 9-1/2"

UNIT PACKAGE: 1

TUBING

Photos not actual size

Clear Flexible Vinyl (PVC)



Our tubing has a broad range of chemical resistance to acids, alkalis and solvents.

It's ideal for use in industrial air pressure line applications, in the food industry (FDA approved), for potable water, and for various gases and chemicals. Not for use with gasoline.

The Clear Flexible Tubing can be used with our connectors which are cataloged on page 174. The tubing can also be installed with our Hose Clamps (refer to the alphabetical index).

Auveco Part No.	I.D.	O.D.	Wall Thickness	*Max. Suggested Working Pressure (PSI @ 70F)
14801	1/8"	1/4"	1/16"	59
14802	3/16"	5/16"	1/16"	51
14803	1/4"	3/8"	1/16"	51
14804	5/16"	7/16"	1/16"	48
14805	3/8"	1/2"	1/16"	41
14807	1/2"	5/8"	1/16"	28
14808	1/2"	3/4"	1/8"	41

Unit Package: 100ft

*We recommend verification by testing of the size and material to be used.

Black O.E.M. Heater Hose



Meets or exceeds SAE20R3 specifications. O.E.M. grade EPDM hose that withstands the abuse of corrosive additives, heat, cold, ozone, weather and abrasion

Auveco Part No.	I.D.	Unit Pkg.
15540	1/2"	50' Roll
15541	5/8"	50' Roll
15542	3/4"	50' Roll

Electronic Fuel Injection Hose



Meets or exceeds SAE 30R9 specifications. Quality fluoroelastomer tube and CM cover handles virtually every fuel on the market. Burst strength exceeds 900 PSI. 180 PSI working pressure

Auveco Part No.	Size	Auveco Clamp No.	Unit Pkg.
19271	1/4" I.D. x 1/2" O.D.	15860	10 ft.
19272	5/16 I.D. x 9/16" O.D.	15861	10 ft.
19273	3/8" I.D. x 5/8" O.D.	15862	10 ft.

Vacuum and Windshield Washer Tubing



Meets SAE J1037 Type 2 Specifications EPDM Rubber

Auveco Part No.	I.D.	O.D.	Fits	Unit Pkg.
4454	7/64"	9/32"	Fits 1/8" Nipple	50'
4456	5/32"	5/16"	Fits 3/16" Nipple	25'
4457	5/32"	5/16"	Fits 3/16" Nipple	50'
4460	7/32"	13/32"	Fits 1/4" Nipple	50'
4462	9/32"	15/32"	Fits 5/16" Nipple	25'
4463	9/32"	15/32"	Fits 5/16" Nipple	50'

WARNING: ALL ITEMS IN CHART Reproductive Risk & Cancer - www.P65Warnings.ca.gov

Fuel Line Hose

Not for Electronic Fuel Injection



Meets the following O.E.M. Specifications:
GM: 6165-M • SAE J30R7 • Chrysler MSEA219

Auveco Fuel Line Hose is of the highest quality and meets all O.E.M. specifications. It has a special chemical resistant interior, a single braid, and a neoprene exterior for maximum life and durability. For temperature range from -29°F to 257°F.

Auveco Hose is designed for gas and diesel fuel lines (except Electronic Fuel Injection), emission control devices, and crankcase ventilation. In addition to the automotive applications, this hose is widely used on lawn mowers, marine motors, tractors and construction equipment to mention only a very few.

Auveco Part No.	Size	Working Pressure	Unit Pkg.
17085	3/16" I.D. x 13/32" O.D.	50 PSI	25'
4464	1/4" I.D. x 1/2" O.D.	50 PSI	25'
4466	5/16" I.D. x 9/16" O.D.	50 PSI	25'
4468	3/8" I.D. x 5/8" O.D.	35 PSI	25'

WARNING: ALL ITEMS IN CHART Reproductive Risk & Cancer - www.P65Warnings.ca.gov

For a complete listing of Barbed Brass Fittings see page 348.

SOLDERLESS TERMINALS

Nylon Insulated • Our Finest

Nylon Insulated with Insulation Grip

Highest Grade Electrolytic Copper Body... Tin Plated to Resist Corrosion

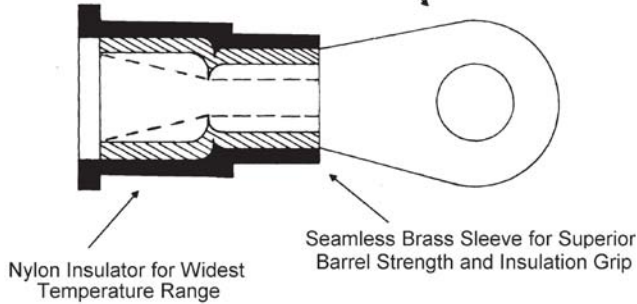

- Superior vibration resistance with insulated grip
- Superior barrel strength
- Constructed to meet the highest military and industrial standards

22-18 Gauge Wire Range (Red)

Actual Size	Stud Size	Auveco Part No.	Unit Pkg.
	#4 - #6	12149	25
	#8 - #10	12150	25
	#12 - 1/4"	17041	50
	#8 - #10	12163	25
	#4 - #6	12164	25
	Butt Connector	5791 16487	50 1000

16-14 Gauge Wire Range (Blue)

Actual Size	Stud Size	Auveco Part No.	Unit Pkg.
	#4 - #6	9052	25
	#8 - #10	9055	25
	#12 - 1/4"	9056	25

16-14 Gauge Wire Range (Blue)

Actual Size	Stud Size	Auveco Part No.	Unit Pkg.
	1/4" - 5/16"	9057	25
	5/16" - 3/8"	9058	25
	#4 - #6	9059	25
	#8 - #10	9060	25
	#8 - #10	9064	25
	Butt Connector	5792 16488	50 1000
	1/4" Female Quick Connect	12148	25
	1/4" Male Quick Connect	12147	25

12-10 Gauge Wire Range (Yellow)

Actual Size	Stud Size	Auveco Part No.	Unit Pkg.
	#8 - #10	12151	25
	#12 - 1/4"	12152	25
	5/16" - 3/8"	12153	25
	#8 - #10	12162	25
	Butt Connector	5793 16489	50 500

WARNING: ALL ITEMS ON PAGE Reproductive Risk & Cancer www.P65Warnings.ca.gov

SOLDERLESS TERMINALS

Vinyl Insulated • Copper • Electro Tin Plated

For an assortment of Solderless Terminals see the Fix-Kits in the green pages

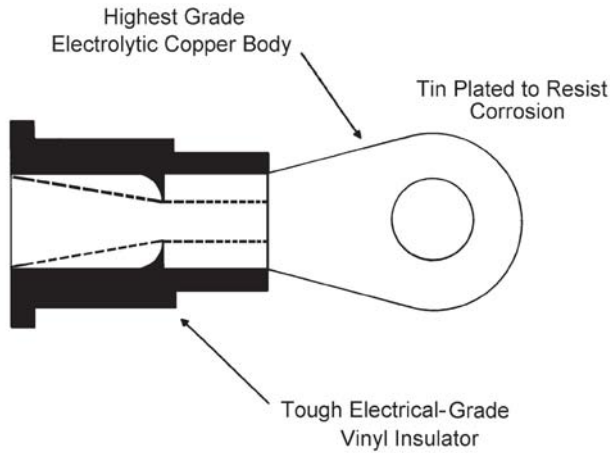

- Funnel barrel for easy wire insertion
- Friction groove in barrel resists wire pullout
- Heat treated for maximum strength

22-18 Gauge Wire Range (Red)

Actual Size	Stud Size	Auveco Part No.	Unit Pkg.
	#4 - #6	5021	100
	#8 - #10	5023	100
	#12 - 1/4"	17040	50
	#8 - #10	5034	100
	#4 - #6	5038	100
	Butt Connector	5047 16484	100 1000
	Closed End Butt Connector 22-14 Ga.	9065	100

16-14 Gauge Wire Range (Blue)

Actual Size	Stud Size	Auveco Part No.	Unit Pkg.
	#4 - #6	5024	100
	#8 - #10	5026	100

16-14 Gauge Wire Range (Blue)

Actual Size	Stud Size	Auveco Part No.	Unit Pkg.
	#12 - 1/4"	5027	100
	5/16" - 3/8"	12144	25
	#4 - #6	5035	100
	#8 - #10	5036	100
	#8 - #10	5040	100
	Butt Connector	5048 16485	100 1000
	Closed End Butt Connector 16-10 Ga.	5072	100

12-10 Gauge Wire Range (Yellow)

Actual Size	Stud Size	Auveco Part No.	Unit Pkg.
	#8 - #10	5028	100
	#12 - 1/4"	5029	100
	1/4" - 5/16"	5030	100
	5/16" - 3/8"	5031	100
	7/16" - 1/2"	5032	100

WARNING: ALL ITEMS ON PAGE Reproductive Risk & Cancer www.P65Warnings.ca.gov

SOLDERLESS TERMINALS

Vinyl Insulated • Copper – Electro Tin Plated

For an assortment of Solderless Terminals see the Fix-Kits in the green pages

12-10 Gauge Wire Range (Yellow)

Actual Size	Stud Size	Auveco Part No.	Unit Pkg.
	#8 - #10	5037	100
	#8 - #10	5041	100
	#10-#12	24058	50
	Butt Connector	5049 16486	100 500
	3-Way Connector	5056	25



8 Gauge Wire Range (Red)

Actual Size	Stud Size	Auveco Part No.	Unit Pkg.
	#12 - 1/4"	17042	25
	1/4" - 5/16"	17043	25
	5/16"-3/8"	17044	25
	7/16" - 1/2"	17045	15
	Butt Connector	17037	10

6 Gauge Wire Range (Blue)



Actual Size	Stud Size	Auveco Part No.	Unit Pkg.
	#12 - 1/4"	17046	15
	1/4" - 5/16"	17047	15
	5/16" - 3/8"	17048	15
	5/16"-3/8"	24060	10
	7/16" - 1/2"	17049	10
	Butt Connector	17038	10

4 Gauge Wire Range (Yellow)

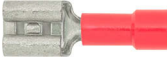

Actual Size	Stud Size	Auveco Part No.	Unit Pkg.
	5/16"-3/8"	17052	10
	Butt Connector	17039	10

 **WARNING:** ALL ITEMS ON PAGE Reproductive Risk & Cancer www.P65Warnings.ca.gov

Quick-Connect Terminals 1/4" Female Terminals Vinyl Insulated

Actual Size	Wire Size	Auveco Part No.	Unit Pkg.
 Red	22-18 Ga.	12155	25
 Blue	16-14 Ga.	5068	100
 Yellow	12-10 Ga.	12157	25





Quick-Connect Terminals Fully Insulated Nylon Mating 1/4" Quick-Connects

Actual Size	Wire Size	Auveco Part No.	Unit Pkg.
	22-18 Ga. Female Red	11827	50
	22-18 Ga. Male Red	11828	50
	16-14 Ga. Female Blue	11606	50
	16-14 Ga. Male Blue	11605	50
	12-10 Ga. Female	11829	25
	12-10 Ga. Male Yellow	11830	25



Quick-Connect Terminals 1/4" Male Tabs • Vinyl Insulated

Actual Size	Wire Size	Auveco Part No.	Unit Pkg.
 Red	22-18 Ga.	12154	25
 Blue	16-14 Ga.	5067	100
 Yellow	12-10 Ga.	12156	25

Quick-Connect Terminals .187 (3/16") Sizes • Vinyl Insulated

Actual Size	Wire Size	Auveco Part No.	Unit Pkg.
	22-18 Ga. Male	17462	25
	22-18 Ga. Female	12159	25
	16-14 Ga. Male, Blue	12165	25
	16-14 Ga. Female, Blue	8781	50

Piggyback Terminals 1/4" Female • Fully Insulated Nylon

Actual Size	Wire Range	Auveco Part No.	Unit Pkg.
	22-18 Ga. 1/4" Tab Std. Barrel Red	19298	15
	16-14 Ga. 1/4" Tab Std. Barrel Blue	19299	15



Fully Insulated Tap Disconnect

Mates with 11828, 11605 & 11830

Wire Range	Auveco Part No.	Unit Pkg.
22-18 Ga.(Red)	12791	10
18-14 Ga.(Blue)	12161	10
12 Ga.(Yellow)	12792	100

Fully insulated connectors are for tapping into a line without stripping the insulation. No special tools are required.

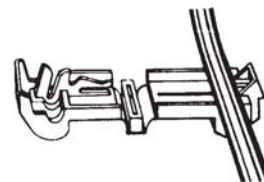

Place wire to be tapped in locating notch. Then close with pliers.

Complete connection with Auveco fully insulated male terminal:
11828 (22-18 Ga.),
11605 (16-14 Ga.) or
11830 (12 Ga.)

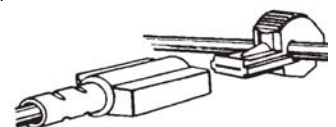

⚠ WARNING: ALL ITEMS ON PAGE Reproductive Risk & Cancer www.P65Warnings.ca.gov

SOLDERLESS TERMINALS



12158
 Vinyl Insulated
 Specialty Terminal
 Wire Range: 1/4" Tab
 Gauge: 16-14
UNIT PACKAGE: 25



17686
 Mini Fuse Blade Type Fuse Tap
 For tapping "hot side" of
 mini fuse type fuse block
 Refer to page 234
UNIT PACKAGE: 50



14474
 Blade Type Fuse Tap
 For tapping "hot side" of fuse block
 Refer to page 173
UNIT PACKAGE: 25



11405
 Fuse Block Accessory Clip
 For add-on electrical equipment
UNIT PACKAGE: 50

SNAP PLUGS AND CONNECTORS

Snap Plugs • 22-18 Gauge Universal • .157" Diameter

Actual Size	Description	Auveco Part No.	Unit Pkg.
	Vinyl Insulated	11604	50
	Insulated Crimp-on Female	10720	10

Mates with 11604

Snap Plugs • 16-14 Gauge Universal • .157" Diameter

Use with 10719 Connector

Actual Size	Description	Auveco Part No.	Unit Pkg.
	Vinyl Insulated	5063	100
	Nylon Insulated	12146	25

Snap Plugs • 16-14 Gauge Ford (American & Lucas) • .176" Dia.

Use with 11602 Connector

Actual Size	Description	Auveco Part No.	Unit Pkg.
	Vinyl Insulated	5062	100

Fully Insulated Crimp-On Female (.157")

Actual Size	Description	Auveco Part No.	Unit Pkg.
	Nylon 16-14 Ga.	10719 17494	10 25

Mates with 5063 & 12146

Fully Insulated Crimp-on Female (.176")

Actual Size	Description	Auveco Part No.	Unit Pkg.
	Nylon 16-14 Ga.	11602 17493	25 50

Mates with 5062 & 12145

Snap Plug Tap-Disconnect

Use Universal Snap Plugs (left column)

Actual Size	Description	Auveco Part No.	Unit Pkg.
	18-14 Ga.	10319	10

Dual Male-Female Adapter

Actual Size	Description	Auveco Part No.	Unit Pkg.
	Converts .250" x .032" Male Tab to 2 Male Tabs	8009	100

	Converts .250" x .032" Male Tab to 2 Male Tabs	8788	25
---	---	-------------	----

 **WARNING:** ALL ITEMS ON PAGE Reproductive Risk & Cancer www.P65Warnings.ca.gov

24-22 Gauge Wire Range (Clear)

Actual Size	Wire Size	Auveco Part No.	Unit Pkg.
	Butt Connector	21317	10







22-18 Gauge Wire Range (Red)

Actual Size	Wire Size	Auveco Part No.	Unit Pkg.
	#6	13656	10
	#10	13657	10
	Butt Connector	13659	10
	.250" Female	13660	10
	.250" Male	13661	10
	#10	13658	10







16-14 Gauge Wire Range (Blue)

Actual Size	Wire Size	Auveco Part No.	Unit Pkg.
	#6	13662	10
	#10	13663	10
	1/4"	13664	10
	5/16"	13665	10
	3/8"	13666	10
	Butt Connection	13669	10

16-14 Gauge Wire Range (Blue)

Actual Size	Wire Size	Auveco Part No.	Unit Pkg.
	.157"	13681	10
Mates with 13682			
	.157"	13682	10
Mates with 13681			
	.250"	13670	10
	.250"	13671	10
	.250" Female	13672 19260	10 25
	.250" Male	13673 19261	10 25

12-10 Gauge Wire Range (Yellow)

Actual Size	Wire Size	Auveco Part No.	Unit Pkg.
	#10	13674	10
	1/4"	13675	10
	3/8"	13676	10
	Butt Connector	13678 19262	10 25
	#10	13677	10
	.250" Female	13679	10
	.250" Male	13680	10

WARNING: ALL ITEMS ON PAGE Reproductive Risk & Cancer www.P65Warnings.ca.gov

SEALED CRIMP & SOLDER TERMINALS & CONNECTORS

Crimped for mechanical reliability, soldered for superior strength and conductivity, and sealed with heat shrink tubing for maximum durability.

Crimp Connector

- Crimp indicators show where the installation tool should be positioned
- Wire-stops in butt connectors prevent over-insertion of the wire
- Window in the connector allows for visual inspection & solder to flow into

Solder

- Flux coating to clean metal surfaces
- Low-temperature solder alloy for ease of installation
- Pre-measured solder to provide the right amount of solder ensuring a solid termination

Heat Shrink Tubing

- Adhesive lined polyolefin to seal the connection
- Translucent tubing to allow for visual inspection











24-22 Gauge Wire Range (Clear)





Actual Size	Wire Size	Auveco Part No.	Unit Pkg.
	Butt Connector	21002	10

20 - 18 Gauge Wire Range (Red)

Actual Size	Wire Size	Auveco Part No.	Unit Pkg.
	#8	21260	10
	#10	21261	10
	1/4"	21262	10
	5/16"	21263	10
	3/8"	21264	10
	1/4" Female Slip-On	21278	10
	1/4" Male Slip-On	21279	10
	Butt Connector	21003	10
	24 - 22 Ga. to 20 - 18 Ga. Step down butt connector	21275	10

16 - 14 Gauge Wire Range (Blue)





Actual Size	Wire Size	Auveco Part No.	Unit Pkg.
	#8	21265	10
	#10	21266	10
	1/4"	21267	10
	5/16"	21268	10
	3/8"	21269	10
	1/4" Female Slip-On	21280	10
	1/4" Male Slip-On	21281	10
	Butt Connector	21004	10
	Butt Connector	24125	10
	20-18 Ga. to 16-14 Ga. Step down butt connector	21276	10

Actual Size	Wire Size	Auveco Part No.	Unit Pkg.
	#8	21270	10
	#10	21271	10
	1/4"	21272	10
	5/16"	21273	10

12 - 10 Gauge Wire Range (Yellow)

⚠ WARNING: ALL ITEMS ON PAGE Reproductive Risk & Cancer www.P65Warnings.ca.gov

Sealed Crimp & Solder Terminals Continued 12 - 10 Gauge Wire Range (Yellow)

Actual Size	Wire Size	Auveco Part No.	Unit Pkg.
	1/4" Female Slip-On	21282	10
	1/4" Male Slip-On	21283	10
	Butt Connector	21005	10
	16-14 Ga. to 12-10 Ga. Step down butt connector	21277	10

WARNING: ALL ITEMS IN CHART Reproductive Risk & Cancer
www.P65Warnings.ca.gov



Crystal Clear™ Ring Terminals

45° barrel allows for proper seating of wire & stronger tubing seal.

Longer neck provides flush surface for maximum contact & ring terminals to be stacked

Auveco. Part No.	Wire Gauge (AWG)	Color Stripe	Stud Size	Unit Pkg.
22963	22-18	Red	#6	15
22964	22-18	Red	#10	15
22958	16-14	Blue	#8	15
22959	16-14	Blue	#10	15
22960	16-14	Blue	1/4"	15
22962	16-14	Blue	5/16"	15
22961	16-14	Blue	3/8"	15
22955	12-10	Yellow	#10	15
22956	12-10	Yellow	1/4"	15
22957	12-10	Yellow	3/8"	15

Crystal Clear™ Fully Insulated Quick-Connect Terminals

.250" X .032" (.80mm) Tab Size and Thickness



Auveco. Part No.	Wire Gauge (AWG)	Color Stripe	Type	Unit Pkg.
22973	22-18	Red	Female	15
22974	22-18	Red	Male	15
22971	16-14	Blue	Female	15
22972	16-14	Blue	Male	15
22969	12-10	Yellow	Female	15
22970	12-10	Yellow	Male	15

Crystal Clear™ Butt Connectors

Seamless barrel with wire stop ensures superior crimp performance & prevents over-insertion



Auveco Part No.	Wire Gauge (AWG)	Color Stripe	Unit Pkg.
22967	22-18	Red	15
22966	16-14	Blue	15
22965	12-10	Yellow	15

Crystal Clear™ Step Down Butt Connectors

Seamless barrel with wire stop ensures superior crimp performance & prevents over-insertion



Auveco Part No.	Wire Gauge (AWG)	Color Stripe	Unit Pkg.
22993	24-22 to 22-18	White/Red	15
22992	22-18 to 16-14	Red/Blue	15
22968	16-14 to 12-10	Blue/Yellow	15
22991	12-10 to 8	Yellow/Red	15

Moisture Resistant Nylon Insulated Butt Connectors



Protect electrical connections from corrosive environments: road chemicals, salt spray, etc. Insert wire and crimp twice (electrical and mechanical) at each end. No need for heat or chemicals.

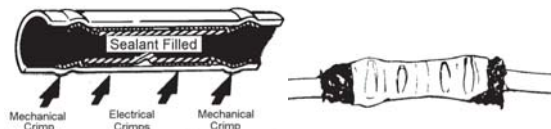

Auveco Part No.	Wire Range	Color	Unit Pkg.
13683	22-18 Ga.	Red	10
13684	16-14 Ga.	Blue	10
13685	12-10 Ga.	Yellow	10

WARNING: ALL ITEMS IN CHART Reproductive Risk & Cancer
www.P65Warnings.ca.gov

Heatless Moisture Resistant Butt Connectors





- Anaerobic sealant creates a barrier against moisture & air and creates an environmentally sealed connection
- Easy to use, simply strip the wire & crimp the connector to activate the sealant
- Nylon insulation is abrasion & puncture resistant
 - No heat tools needed for installation







Auveco Part No.	Wire Range	Color	Unit Pkg.
25019	22-18 Ga.	Red	10
25020	16-14 Ga.	Blue	10
25021	12-10 Ga.	Yellow	10

WARNING: ALL ITEMS IN CHART Reproductive Risk & Cancer
www.P65Warnings.ca.gov

**Solderless Terminals
Non-Insulated
22-18 Gauge Wire Range**

Actual Size	Wire Size	Auveco Part No.	Unit Pkg.
	#4-#6	5000	100
	#8-#10	5002	100
	Butt Connector	5044	100

16-14 Gauge Wire Range

Actual Size	Wire Size	Auveco Part No.	Unit Pkg.
	#4-#6	5003	100
	#8-#10	5005	100
	#12-1/4"	5006	100
	#4-#6	5014	100
	#8-#10	5015	100
	Butt Connector	5045	100
	#14-#16	24057	100

**16-14 Gauge Wire Range
High Temperature**

Actual Size	Wire Size	Auveco Part No.	Unit Pkg.
	#8-#10	17491	50
	#12-1/4"	17492	50



#16-#14 24191 100



.187" Female 10724 25







1/4" Female 5066 100





1/4" Male 17490 50

12-10 Gauge Wire Range

Actual Size	Wire Size	Auveco Part No.	Unit Pkg.
	#8-#10	5007	100
	#12-1/4"	5008	100
	5/16"	5009	100
	3/8"	5010	100
	Butt Connector	5046	100

**Parallel Connectors
(Fusible Link Connectors)**

Actual Size	Wire Size	Auveco Part No.	Unit Pkg.
	16-14 Ga.	12630	100
	12-10 Ga.	12631	50

WARNING: ALL ITEMS ON PAGE Reproductive Risk & Cancer www.P65Warnings.ca.gov





Parallel Connectors Proper Wire Insertion
Splice Clips

Actual Size	Wire Size	Auveco Part No.	Unit Pkg.
	Max. of 3 #16 Ga.	18952	50
	Max of 3 #12 Ga.	22341	25

8 Gauge Wire Range

Actual Size	Wire Size	Auveco Part No.	Unit Pkg.
	1/4"	15158	25

	5/16"	15159	25
--	-------	--------------	----

	3/8"	15160	25
---	------	--------------	----

	1/2"	15161	25
---	------	--------------	----

	#8	24046	25
---	----	--------------	----

6 Gauge Wire Range

Actual Size	Wire Size	Auveco Part No.	Unit Pkg.
	1/4"	15162	25



5/16" **15163** 25



3/8" **15164** 25



1/2" **15165** 25



#6 **24047** 25

4 Gauge Wire Range

Actual Size	Wire Size	Auveco Part No.	Unit Pkg.
	1/4"	15166	10

	5/16"	15167	10
--	-------	--------------	----

	3/8"	15168	10
--	------	--------------	----

WARNING: ALL ITEMS ON PAGE Reproductive Risk & Cancer www.P65Warnings.ca.gov

Tap Splice Electrical Connectors



Make quick, reliable pre-insulated tap splices, in-line splices, pass-through connections and pigtail connections without stripping, twisting, soldering or using special tools.

Easy to use:

- Open the connector making sure the piercing barb is clear of the wire channels.
- Insert unstripped wires in the proper channels.
- Use pliers to squeeze down the piercing barb until the top is flush with the connector body.
- Close the hinged cover so it locks securely.

Auveco Part No.	Wire Size	Color	Unit Pkg.
17036	22-18 Ga.	Red	25
9481	18-14 Ga.	Blue	25
14897	18-14 Ga.	Blue	500



10385
Tan

Heavy duty self-stripping connector designed for 14, 16, 18 gauge wire connected on to 10 or 12 gauge automotive wire. Ideal for over the road equipment where tap, in-line, and pigtail splices are required.

UNIT PACKAGE: 10



10386
Yellow

Designed exclusively for 10 or 12 gauge splicing on heavy duty vehicle wiring. Tap, in-line, and pigtail splices made quick and easy with this self-stripping connector.

UNIT PACKAGE: 10



10319

Bullet receptacle connector for use with 18-14 gauge wire. Mates with Auveco snap plugs 5063 and 12146. Place wire to be tapped into connector channel, snap body together and lock into place with pliers.

UNIT PACKAGE: 10

Moisture-Resistant Tap Connector

Tap connector with patented application system forces protective gel around the wire and element, providing a moisture-resistant barrier to destructive substances such as salt water and other corrosive environments. Withstands continuous operating temperatures of -40°C to 75°C (-40°F to 167°F).

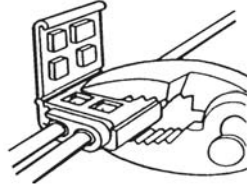

Auveco Part No.	Wire Size	Color	Unit Pkg.
17360	18-14 Ga.	Blue	50

Electrical Connectors



Fully insulated connector for tapping into a line without stripping the insulation. No special tools are required.

Place wire to be tapped in locating notch. Then close with pliers.

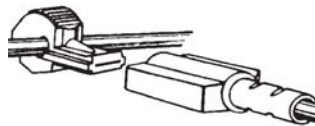
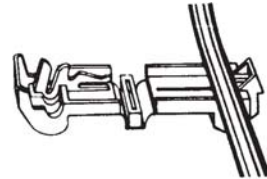

Make connection with Auveco insulated male terminal: 11828 (22-18 Gauge), 11605 (16-14 Gauge) or 11830 (12 Gauge)

Auveco Part No.	Wire Size	Color	Unit Pkg.
12791	22-18 Ga.	Red	10
12161	18-14 Ga.	Blue	10
14898	18-14 Ga.	Blue	100
12792	12 Ga.	Yellow	10



14920
With Sealant

Self-stripping connector for making 2 or 3 wire pigtail connections with a wire range of 22-14 gauge.

Simply insert 2 or 3 unstripped wires completely into the connector. Hold a crimping tool perpendicular to the wires and make the connection by driving the cap down. For use to 600V maximum.

UNIT PACKAGE: 10

O.E.M. SHELLS

GM Weather Pack Series • *Photos not actual size*

Sec. 12



15949
(12010996)
Nylon

Single Cavity Shroud
Mates with Auveco 15950

UNIT PACKAGE: 25



15953
(12010717)
Nylon

Triple Cavity Shroud
Mates with
Auveco 15954

UNIT PACKAGE: 15



18147
(12015798)
Nylon

4 Cavity Square Tower
Mates with Auveco 18148

UNIT PACKAGE: 5



15950
(12015791)
Nylon

Single Cavity Tower
Mates with Auveco 15949

UNIT PACKAGE: 25



15954
(12015793)
Nylon

Triple Cavity Tower
Mates with
Auveco 15953

UNIT PACKAGE: 15



18148
(12015024)
Nylon

4 Cavity Square Shroud
Mates with Auveco 18147

UNIT PACKAGE: 5



15951
(12010973)
Nylon

Double Cavity Shroud
Mates with Auveco 15952

UNIT PACKAGE: 25



18145
(12015797)
Nylon

4 Cavity Flat Tower
Mates with Auveco 18146

UNIT PACKAGE: 5



18149
(12034342)
Nylon

5 Cavity Round Tower
Mates with Auveco 18150

UNIT PACKAGE: 2



15952
(12015792)
Nylon

Double Cavity Tower
Mates with Auveco 15951

UNIT PACKAGE: 25



18146
(12010974)
Nylon

4 Cavity
Flat Shroud
Mates with
Auveco 18145

UNIT PACKAGE: 5



18150
(12065158)
Nylon

5 Cavity
Round Shroud
Mates with
Auveco 18149

UNIT PACKAGE: 5



18151
(12015799)
Nylon

6 Cavity Flat Tower
Mates with Auveco 18152

UNIT PACKAGE: 3

O.E.M. SHELLS & TERMINALS

GM Weather Pack Series • *Photos not actual size*



18152

(12010975)
Nylon

6 Cavity Flat Shroud
Mates with Auveco 18151

UNIT PACKAGE: 5



14462

(12014012)

Weather Pack Terminal Extractor Tool
Designed for extracting Weather Pack terminals from their connector housing. Slide the hollow shaft of the tool over the retention barbs of the terminal. Then pull the terminal out of its shell.

UNIT PACKAGE: 1

O.E.M. TERMINALS

GM Weather Pack Series

Male Terminals are used with Shrouds • Female Terminals are used with Towers



20747

(GM: 12089307)
Tin Plated

Gauge: 24-22
Mates with Auveco 20748

UNIT PACKAGE: 15

WARNING: Reproductive Harm & Cancer
www.P65Warnings.ca.gov



15948

(12010085, 12089305)
Tin Plated

Gauge: 16-14
Mates with Auveco 15937

UNIT PACKAGE: 50

WARNING: Reproductive Harm & Cancer
www.P65Warnings.ca.gov



20748

(GM: 12020801)
Tin Plated

Gauge: 24-22
Mates with Auveco 20747

UNIT PACKAGE: 15

WARNING: Reproductive Harm & Cancer
www.P65Warnings.ca.gov



15937

(12010182, 12124580)
Tin Plated

Gauge: 16-14
Mates with Auveco 15948

UNIT PACKAGE: 50

WARNING: Reproductive Harm & Cancer
www.P65Warnings.ca.gov



14151

(12034051, 12089188)
Tin Plated

Gauge: 20-18
Mates with Auveco 14150

UNIT PACKAGE: 50

WARNING: Reproductive Harm & Cancer
www.P65Warnings.ca.gov



18325

(12089306, 12124587)
Tin Plated

Gauge: 12
20 Amp Max.
Mates with Auveco 18324

UNIT PACKAGE: 25

WARNING: Reproductive Harm & Cancer
www.P65Warnings.ca.gov



14150

(12033674, 12089040)
Tin Plated

Gauge: 20-18
Mates with Auveco 14151

UNIT PACKAGE: 50

WARNING: Reproductive Harm & Cancer
www.P65Warnings.ca.gov



18324

(12015917, 12124581)
Tin Plated

Gauge: 12
20 Amp Max.
Mates with Auveco 18325

UNIT PACKAGE: 25

WARNING: Reproductive Harm & Cancer
www.P65Warnings.ca.gov

O.E.M. TERMINALS

GM Weather Pack Series

Male Terminals are used with Shrouds • Female Terminals are used with Towers



20749

(GM: 12015899)
Red Silicone

Cable Seal

Use with Auveco 20747 & 20748

UNIT PACKAGE: 25



14152

(12015323)
Green Silicone

Cable seal

Use with Auveco 14150, 14151, 15937 & 15948

UNIT PACKAGE: 50



18326

(12010293)
Gray Silicone

Use with 14 Gauge GPT & Cross-Link
Polyethylene Primary Wire

UNIT PACKAGE: 25



20618

(12015193)
Blue Silicone

Use with Auveco 18324 & 18325

UNIT PACKAGE: 25



15955

(12010300)
Silicone

Cavity Plug

Used to plug empty cavities in connector shell

UNIT PACKAGE: 25

 **WARNING:** Reproductive Harm & Cancer
www.P65Warnings.ca.gov



14153

(12014836)

Gauge: 20-18
Set of 14150 & 14152

UNIT PACKAGE: 25 Sets

 **WARNING:** Reproductive Harm & Cancer
www.P65Warnings.ca.gov



14154

(12014837)

Gauge: 20-18
Set of 14151 and 14152

UNIT PACKAGE: 25 Sets

 **WARNING:** Reproductive Harm & Cancer
www.P65Warnings.ca.gov

15921



Repair Lead Gauge: 20-18
Gauge Wire: 10" of 18

UNIT PACKAGE: 5

 **WARNING:** Reproductive Harm & Cancer
www.P65Warnings.ca.gov

15922



Repair Lead Gauge: 20-18
Gauge Wire: 10" of 18

UNIT PACKAGE: 5



8775

(2962984)

Insulates 8776
Mates with shell 8777

UNIT PACKAGE: 25



8777

(2962448)

Insulates 8774 and 15957
Mates with shell 8775

UNIT PACKAGE: 25

GM Micro - Pack Terminals



14883

(12020757)
Tin Plated

Gauge: 20-18

UNIT PACKAGE: 10



15924

(12040902)
Tin Plated

Gauge: 22

UNIT PACKAGE: 50

 **WARNING:** Reproductive Harm & Cancer
www.P65Warnings.ca.gov

GM Pack-Con I Series Terminals



11948

(8900524, 12020320)
Tin Plated

Gauge: 16-14
Mates with Auveco 15935

UNIT PACKAGE: 25



15935

(12020347)

Gauge: 16-14
Mates with Auveco 11948

UNIT PACKAGE: 50

GM Pack-Con H.D. I Series Terminals



15960

(12033817)
Tin Plated

Gauge: 12-10

UNIT PACKAGE: 25

GM Pack-Con III Series Terminals



18650

(12020321)
Brass

Gauge: 16-14

UNIT PACKAGE: 25

GM Metri-Pack 150 Series Terminals



18653

(12045773)
Tin Plated

Gauge: 20-18

UNIT PACKAGE: 25



15498

(12047581)
Tin Plated

Gauge: 20-18
Mates with Auveco 15497

UNIT PACKAGE: 25



15497

(12047680)
Tin Plated

Gauge: 20-18
Mates with Auveco 15498

UNIT PACKAGE: 25

WARNING: ALL ITEMS ON PAGE Reproductive Risk & Cancer www.P65Warnings.ca.gov



18654

(12048074)
Tin Plated

Gauge: 20-18

UNIT PACKAGE: 25



15499

(GM: 12047767; Chry: 4368618)
Tin Plated

Gauge: 20-16

UNIT PACKAGE: 25



20212

(12129484)
Tin Plated

Gauge: 18-16

UNIT PACKAGE: 15



20213

(12129373)
Tin Plated

Gauge: 22-20

UNIT PACKAGE: 15

GM Metri-Pack 150.2 Pull to Seat



20214

(12124075)
Tin Plated

Gauge: 18-16

UNIT PACKAGE: 15



20215

(12124076)
Tin Plated

Gauge: 22-20

UNIT PACKAGE: 15

GM Metri-Pack 150.1 Series Terminal



16806

(12052922, 12089340)

Gauge: 20-18
Not for use with 150.2 Series

UNIT PACKAGE: 25

GM 56 Series Terminal



18690
(2973215)
Tin Plated

Two Gauge Leads: 16-14
Or One Gauge Lead: 12
Fits 5/16" Male Tab

UNIT PACKAGE: 25



15957
(2965142)
Tin Plated

Gm 56 Series
Gauge: 16-14
Insulated with shell 8777

UNIT PACKAGE: 25



8774
(2084421,2962447)
Unplated Brass

Gm 56 Series
Gauge: 16-14
Insulated with shell 8777
Mates with terminal 8776

UNIT PACKAGE: 50



23167

Terminal Female
Gauge: 14/16
Mates w/Pin Style Male Terminal
Ford & General Purpose

UNIT PACKAGE 25



8776
(2962987)
Tin Plated

Gm 56 Series
Gauge: 16-14
Insulated with shell 8775
Mates with terminal 8774

UNIT PACKAGE: 50



17002
(8917283;12015878)
Tin Plated
Copper

Gm 56 Series
Gauge: 12-10
Insulated with shell 8775

UNIT PACKAGE: 25



23249
(D4AB-14474-JA)

Female Blade Terminal
Gauge: 12
Fits 1/4" Male Terminal
Ford & General Purpose

UNIT PACKAGE 25

WARNING: ALL ITEMS ON PAGE Reproductive Risk & Cancer www.P65Warnings.ca.gov

GM 59 Series Terminal



18651
(2973216)
Tin Plated

Gauge: 16-14
Blade Size: 5/16"

UNIT PACKAGE: 25

GM Metri-Pack 280 Series Terminal



18659
(12129497)
Tin Plated

Gauge: 16-14
Mates with Auveco 18658

UNIT PACKAGE: 25



14880
(12020116)
Tin Plated

Gauge: 16-14
Mates with Auveco 14881

UNIT PACKAGE: 25

GM Metri-Pack 280 Series Terminal



15946
(12034047)
Tin Plated

Gauge: 20-18
Mates with Auveco 15947

UNIT PACKAGE: 50



18658
(12129493)
Tin Plated

Gauge: 16-14
Mates with Auveco 18659

UNIT PACKAGE: 25



14881
(12015857)
Tin Plated

Gauge: 16-14
Mates with Auveco 14880

UNIT PACKAGE: 25



15947
(12034046)
Tin Plated

Gauge: 20-18
Mates with Auveco 15946

UNIT PACKAGE: 50



20216
(12015858)
Tin Plated

Gauge: 12-10

UNIT PACKAGE: 15



20220
(12186456)
Tin Plated

Gauge: 14-12
Mates with Auveco 20226

UNIT PACKAGE: 15



20226
(12092344)
Tin Plated

Gauge: 14-12
Mates with Auveco 20220

UNIT PACKAGE: 15

GM Metri-Pack 280 Series Terminal



20221
(12186457)
Tin Plated

Gauge: 18-16
Mates with Auveco 20227

UNIT PACKAGE: 15



20227
(12092345)
Tin Plated

Gauge: 18-16
Mates with Auveco 20221

UNIT PACKAGE: 15

GM Metri-Pack 280 Series Tangless



20217
(12110842)
Tin Plated

Gauge: 14-12
Used without cable seal

UNIT PACKAGE: 15



20222
(12110845)
Tin Plated

Gauge: 14-12
Used with cable seal

UNIT PACKAGE: 15



20223
(12129409)
Tin Plated

Gauge: 16-14
Used with cable seal

UNIT PACKAGE: 15



20218
(12110844)
Tin Plated

Gauge: 18-16
Used without cable seal

UNIT PACKAGE: 15



20224
(12110847)
Tin Plated

Gauge: 18-16
Used with cable seal

UNIT PACKAGE: 15

WARNING: ALL ITEMS ON PAGE Reproductive Risk & Cancer www.P65Warnings.ca.gov

GM Metri-Pack 280 Series Tangless



20219
(12110843)
Tin Plated

Gauge: 22-20
Used without Cable seal

UNIT PACKAGE: 15



20225
(12110846)
Tin Plated

Gauge: 22-20
Used with cable seal

UNIT PACKAGE: 15

GM Metri-Pack 280 Fuel Injector



20230
(12103360)
Tin Plated

Gauge: 22-20

UNIT PACKAGE: 15

GM Metri-Pack 480 Series



15939
(12020120)
Tin Plated

Gauge: 16-14
Blade Width: 3/16"
Mates with Auveco 15938

UNIT PACKAGE: 25



15938
(12015861)
Tin Plated

Gauge: 16-14
Mates with Auveco 15939

UNIT PACKAGE: 25

GM Metri-Pack 630 Series



15944
(12020126)
Tin Plated

Gauge: 16-14
Blade Width: 1/4"
Mates with Auveco 15945

UNIT PACKAGE: 50

GM Metri-Pack 630 Series



15945
(12015870)
Tin Plated

Gauge: 16-14
Mates with Auveco 15944

UNIT PACKAGE: 50

GM Metri-Pack 630 Pull to Seat



20231
(12066614)
Tin Plated

Gauge: 16-14

UNIT PACKAGE: 15

GM Micro-Pack 100 W Series Terminals



20209
(12084912)
Gold/Nickel Plated

Gauge: 18

UNIT PACKAGE: 10



20210
(12084913)
Gold/Nickel Plated

Gauge: 22-20

UNIT PACKAGE: 10

Ford Wedgelock Pin Type Terminals



20475
(E7EB-14461-BA)
Tin Plated

Gauge: 20-18
Diameter Pin: .060"

UNIT PACKAGE: 25

WARNING: ALL ITEMS ON PAGE Reproductive Risk & Cancer www.P65Warnings.ca.gov

Ford Wedgelock Pin Type Terminals



14887

(D1AB-14461-AA)

Gauge: 20-18
Diameter Pin: .110"
Mates with Auveco 14888

UNIT PACKAGE: 25



14888

(D1AB-14488-CA)

Gauge: 20-18
Diameter Pin: .110"
Mates with Auveco 14887

UNIT PACKAGE: 25

Ford Mini Block Terminals



16342

(E7EB-14421-EA)

Gauge: 20-18
Blade Width: 1/8"
Mates with Auveco 16344

UNIT PACKAGE: 25



16344

(E7EB-14474-CA)

Gauge: 20-18
For 1/8" Blade
Mates with Auveco 16342

UNIT PACKAGE: 25

Ford Standard Box Terminals



16348

(E8EB-14474-VA)

Tin Plated

Gauge: 16-14
For 3/16" Blade

UNIT PACKAGE: 25



14889

(D8BB-14474-BA, D3AB-14474-DA)

Gauge: 20-18

UNIT PACKAGE: 25

Ford Terminals



20815

(D20B-14421-BB)

Gauge: 20-18
Blade Width: 3/16"
Replaces Auveco 14890

UNIT PACKAGE: 25



20816

(D5AB-14474-FA, D3AZ-14474-G)

Gauge: 20-18
Replaces Auveco 14891

UNIT PACKAGE: 25

Chrysler Quick Connect Terminals



16349

(3843386)

Gauge: 16-14
Blade Width: 1/4"

UNIT PACKAGE: 25

Chrysler Terminals



16801

(7368261)

Gauge: 20-18
Diameter Pin: 3/32"
Male

UNIT PACKAGE: 25



16804

(4304729)

Gauge: 24-18
Double Cantilever Spring Terminal
Used with P.C. board connections &
general purpose

UNIT PACKAGE: 25

WARNING: ALL ITEMS ON PAGE Reproductive Risk & Cancer www.P65Warnings.ca.gov



14892

(GM: 2965470;
Ford: C5AB-14474-B;
Chry: 2096466)
Unplated Brass

Gauge: 20-18
Female: 1/4"

UNIT PACKAGE: 25



21401

(GM: 2984172;
Ford: C8AB-14463N;
Chry: 4274166)
Tin Plated

Gauge: 16-14
Stud Size: 1/4" (6.3mm)
Locking Type

UNIT PACKAGE: 10



15504

(GM: 2965580;
Ford: C1SF-14474-A;
Chry: 2096467)
Unplated Brass

Gauge: 14-12
Female: 1/4"

UNIT PACKAGE: 25

MATE-N-LOCK TERMINALS



18855

Tin Plated Brass

Gauge: 20-14
Diameter Pin: .084"
Single Retention Barb
Mates with Auveco 18856

UNIT PACKAGE: 25



18857

Tin Plated Brass

Gauge: 20-14
Diameter Pin: .084"
Dual Retention Barbs
Mates with Auveco 18858

UNIT PACKAGE: 25



18856

Tin Plated Brass

Gauge: 20-14
Diameter Pin: .084"
Single Retention Barb
Mates with Auveco 18855

UNIT PACKAGE: 25



18858

Tin Plated Brass

Gauge: 20-14
Diameter Pin: .084"
Dual Retention Barbs
Mates with Auveco 18857

UNIT PACKAGE: 25

 **WARNING:** ALL ITEMS ON PAGE Reproductive Risk & Cancer www.P65Warnings.ca.gov

CRIMPING & CUTTING TOOLS

Photos not actual size

Terminal Extractor Picks



Photo not actual size

Used to release most GM, Ford and Chrysler OEM terminals from their insulating shells. Not suitable for round, pin-type terminals.

14884
(12012000)

Narrow Blade (.050")

UNIT PACKAGE: 1

14885
(8913369)

Wide Blade (.090")

UNIT PACKAGE: 1

20583
(12094429)

Micro Terminal Extractor Pick

.035" Wide Blade used to release: 150 Metri-Pack, 280 Metri-Pack, 280 Tangless, 280 Bus Bar, 630 Pull to Seat, GT 150, GT 280, Wedge Base Light Socket terminals and indexing Candelabra Bayonet Double Contact Light Socket terminals.

UNIT PACKAGE: 1

20901

Electrical Connector Separator

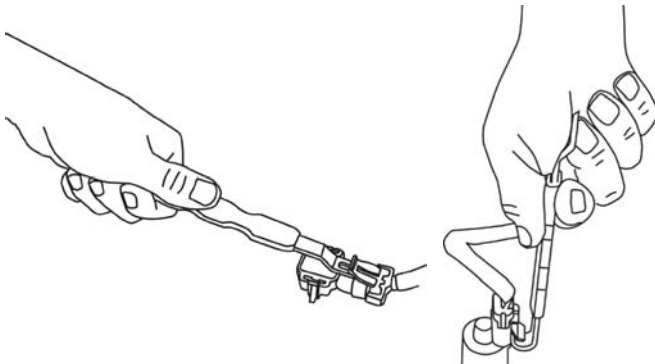

Quickly disconnects electrical connectors without damage. Simply engage the tool tip behind the connector locking clip and then pull or push to disconnect. The tool is double-ended to fit different access angles. Works on Weather Pack and other automotive electrical connectors.

UNIT PACKAGE: 1

15035

Self-Adjusting Wire Stripper/Crimping Tool



Photos not actual size

The quick and easy way to strip wire. Unique steel jaws self-adjust to strip any 26 - 10 gauge wire. Only light handle pressure is needed to make wire stripping fast and easy.

Crimps insulated and non-insulated 22 - 10 gauge and 7mm/8mm terminals

Also features precision machined blade for cutting wire sharp and smooth.
Overall Length: 8-1/4"

UNIT PACKAGE: 1

21424

Wire Stripper for Recessed Areas



This specially designed, narrow profile tool provides easy access to limited and hard-to-reach areas.

Strips 22-12 gauge single or multiple-stranded conductor wire and automatically adjusts to the wire size. The tool has an adjustable strip length gauge and built in wire cutter.
Lightweight and easy to use

UNIT PACKAGE: 1

CRIMPING & CUTTING TOOLS

Photos not actual size

Open Barrel Terminal Crimping Tool For O.E.M. Terminals



16004

Duplicates factory crimps on open barrel terminals used in automotive, computer and control applications. Features five machined and hardened crimp stations for 14 to 24 gauge wire terminations. Parallel jaws eliminate faulty crimps. Overall Length: 8-1/2"

UNIT PACKAGE: 1

Insulation Crimp:

Crimp Station A for 14-18 Gauge
Crimp Station B for 20-24 Gauge

Stripped Wire Crimp:

Crimp Station C for 14-16 Gauge
Crimp Station D for 18-20 Gauge
Crimp Station E for 22-24 Gauge

7711



Cuts and strips 22-8 gauge wire. Crimps insulated and non-insulated solderless terminals in sizes from 22-10 gauge. Overall Length: 9"

UNIT PACKAGE: 1

20751
(GM: 12014254)

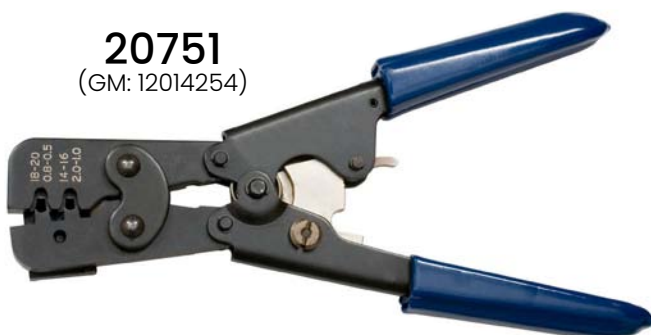

Weather Pack Crimping Tool designed specifically to crimp only Weather Pack 20-18 Gauge & 16-14 Gauge Weather Pack seals and terminals in one cycle. Ratchet mechanism ensures completion of cycle.

UNIT PACKAGE: 1

20750

Micro Crimper
30-16 Gauge
Best for 24-20 Gauge



Insulation Crimp:

Crimp Station A for 20-16 Gauge
Crimp Station B for 30-22 Gauge

Stripped Wire Crimp:

Use Crimp Station C for 18-16 Gauge
Use Crimp Station D for 22-20 Gauge
Use Crimp Station E for 30-24 Gauge

UNIT PACKAGE: 1

20752

(GM: 12085270)

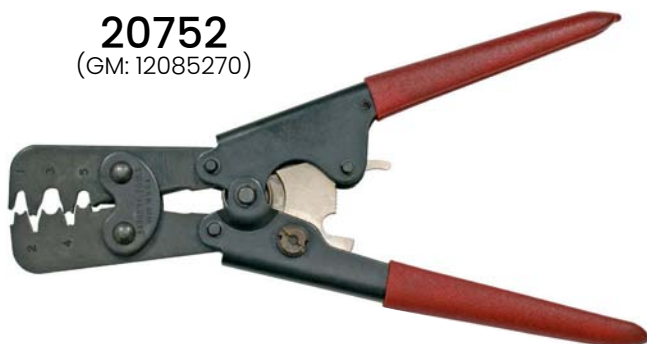

20-14 Gauge

Crimps most sealed GM terminals
Ratchet mechanism ensures completion of crimp cycle

Seal Crimp:

Crimp Station 1 for 150 Series Metri-Pack Seals
Crimp Station 3 for 480 & 630 Series Metri-Pack Seals
Crimp Station 5 for Weather Pack & 280 Series Metri-Pack Seals

Stripped Wire Crimp:

Crimp Station 2 for 20-18 Gauge
Crimp Station 4 for 16-14 Gauge

UNIT PACKAGE: 1

Twist-Type Wire Connectors

Color: Gray



Joins 18 & 16 Gauge Wires
Minimum of 2 #18 Gauge Wires
Maximum of 2 #16 Gauge Wires

10378: UNIT PACKAGE: 25

15204 UNIT PACKAGE: 100

Color: Blue



Joins 18-14 Gauge Wires
Minimum of 2 #18 Gauge Wires
Maximum of 3 #16 Gauge Wires

10379 UNIT PACKAGE: 25

15205 UNIT PACKAGE: 100

Color: Orange



Joins 18-14 Gauge Wires
Minimum of 2 #18 Gauge Wires
Maximum of 3 #16 Ga &
1 #18 Gauge Wires

10380 UNIT PACKAGE: 25

15206 UNIT PACKAGE: 100

Color: Yellow



Joins 18-12 Gauge Wires
Minimum of 1 #14 Gauge &
1 #18 Gauge Wires
Maximum of 2 #14 Gauge &
3 #16 Gauge Wires

10381 UNIT PACKAGE: 25

Color: Red



Joins 18-10 Gauge Wires
Minimum of 1 #12 Gauge &
2 #18 Gauge Wires
Maximum of 2 #10 Gauge &
1 #12 Gauge Wires

10382 UNIT PACKAGE: 25

15208 UNIT PACKAGE: 100

Twist-Type Wire Connectors

Combines both the wide range and torque of wing-style connectors with a new flexible skirt that provides over-strip protection without taking additional space in the electrical box.



Wing Twist-Type Wire Connectors

Color: Blue

Joins 14-6 Ga. Wires
Minimum of 1 #10 Ga. & 1
#12 Ga. Wires
Maximum of 1 #6 Ga. & 2
#8 Ga.

10384 UNIT PACKAGE: 25

15209 UNIT PACKAGE: 50

15705
Yellow



Joins 22-12 Ga. Wires
Minimum of 2 #18 Ga. Wires
Maximum of 2 #12 Ga. Wires

UNIT PACKAGE: 50

15706
Red



Joins 20-8 Ga. Wires
Minimum of 2 #16 Ga. Wires
Maximum of 4 #12 Ga. Wires

UNIT PACKAGE: 50

CIRCUIT TESTERS

Photos not actual size

Sec. 12

20818

Computer Safe Automotive Logic Probe



This circuit tester with its high impedance feature draws less than 7 milliamps to protect all vehicle circuits including computerized engine and body controls, sensitive electronic sensors, microprocessors, electronic ignition components and air bags. Instructions included.

For 6, 12 and 24 volt systems

Insulated probe has an exposed length of 3-3/8"
Includes Protect-A-Terminal® Probe Adapter to prevent damage to electrical connectors
6 feet of heavy duty, 18 gauge dual leads with large battery clips for easy hook-up.

UNIT PACKAGE: 1

20819

Heavy Duty Circuit Tester



An excellent quality electrical circuit tester for checking 6 and 12 volt systems. It's made to last! Has a heavy duty battery clip. 5 feet of tough, flexible, heavily insulated rubber coated wire is retained in a spring supported strain-relief design that withstands the most rugged use.

UNIT PACKAGE: 1

**For Troubleshooting
DC Primary Circuits
on 6 & 12 Volt Vehicles**

16420



Features:

- 4 Feet of Wire
- Mechanical Strain Relief
- Impact & Chemical Resistant Housing
- 8" Long Probe/Housing
- Super Sharp Probe, Tempered to Last
- 2" Long Alligator Clip

Use to Check:

Lighting Systems
Wipers
Horn
Electric Clock,
Windows, Locks
Fuses
Relays

UNIT PACKAGE: 1

WIRE LOOM

Split Flexible Tubing • Maximum Temperature of 345°F

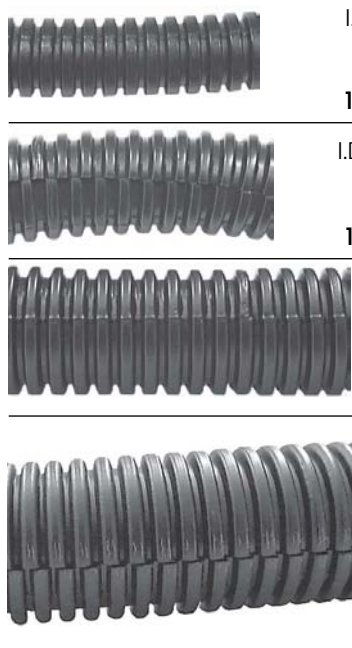

I.D. 1/4" - O.D. 3/8"
Nylon 6 - Black
14201 50' Length (Bulk)

I.D. 3/8" - O.D. 9/16"
Nylon 6 - Black
14202 50' Length (Bulk)

I.D. 1/2" - O.D. 11/16"
Nylon 6 - Black
14203 50' Length (Bulk)

I.D. 5/8"
O.D. 13/16"
Nylon 6
Black
20536:
50' Length

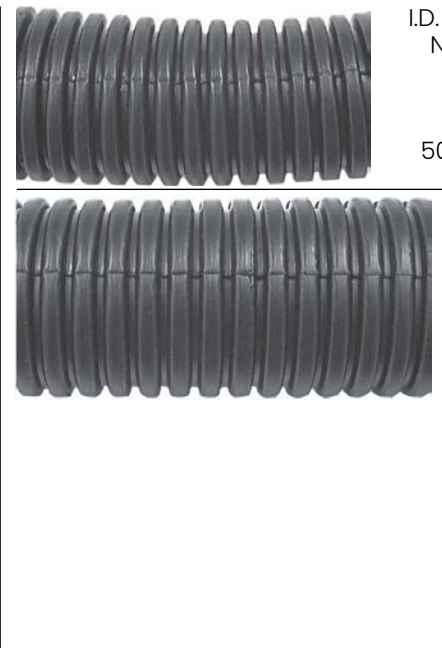

I.D. 3/4" - O.D. 15/16"
Nylon 6 - Black
14204
50' Length (Bulk)

I.D. 1"
O.D. 1-1/8"
Nylon 6
Black
18194:
25' Length

SXL Cross-Linked Polyethylene Wire

- Abrasion-resistant design is resistant to moisture, oil, grease, gasoline, and other damaging solvents
- Enhanced durability and self-extinguishing insulation
- Works well in engine compartments where strict temperature ranges are required.
- Temperature rated at -40°C (-40°F) 125°C (257°F)
- Specifications: SAE J1128, Ford ESB-MIL 123A, and Chrysler MS-5919



Gauge	Stranding	Outer Diameter	Auveco Part No.					White	Yellow
			Black	Brown	Green	Red			
20	7 x 28	0.096	22730	22731	22732	22733	22734	22735	
18	16 x 30	0.108	22736		22737	22738	22739		
16	19 x 29	0.121	22740		22741	22742	22743		
14	19 x 27	0.139	22744		22745	22746	22747		
12	19 x 25	0.164	22748		22749	22750	22751		
10	19 x 23	0.196	22752		22753	22754	22755		

100 Foot Spool

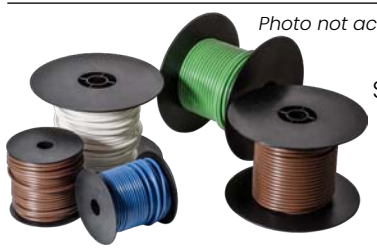

Primary Wire

Standard PVC Insulation (SE/GPT Type) Suitable for most automotive applications. Free of stripping, abrasion resistant, meets most O.E.M. vehicle standards
UNIT PACKAGE: 1 Roll

The lower the gauge number, the thicker the wire (i.e. 10 gauge is thicker than 16 gauge)

Gauge	Stranding	Outer Diameter	Auveco Part No.				Length
			Red	White	Black	Blue	
18	16 x 30	.092	20486	20487	20488	20489	45 Ft.
16	19 x 29	.104	20490	20491	20492	20493	35 Ft.
12	19 x 25	.142	20494	20495	20496		15 Ft.
10	19 x 23	.175	20498	20499	20500	20501	10 Ft.

PRIMARY AND FUSIBLE WIRE

Photos not actual size

25 Foot Spool

Gauge	Stranding	Outer Diameter	Auveco Part No.					
			Red	White	Black	Blue	Green	Yellow
14	19 x 27	.117	12419	12420	12421	12422	15239	15240

100 Foot Spool

Gauge	Stranding	Outer Diameter	Auveco Part No.						
			Red	White	Black	Blue	Green	Yellow	Brown
20	10 x 30	.085	21339	21340	21341	21342	21343	21344	21345
18	16 x 30	.092	12423	12424	12425	12426	12427	12428	15256
16	19 x 29	.104	12429	12430	12431	12432	12433	12434	15257
14	19 x 27	.117	12435	12436	12437	22725	12439	12440	15258
12	19 x 25	.142	12441	12442	12443	12444	15259	15260	22726
10	19 x 23	.175	12445	22727	12447		22728		22729

FUSIBLE LINKS

Photos not actual size



Universal Fusible Links

Auveco Part No.	Gauge	Length	Replaces	Unit Pkg.
12627	18	9"	Chry: 3843392 & other 18 Ga. links	5
12628	16	9"	GM: 6292996, 8903489 Ford D3AZ-14526-E & other 16 Ga. links	5
17465	12	9"	GM: 6293923	5
17464	10	9"	GM: 12077140	5



Test Clips



Type 1



Type 2

Auveco Part No.	Type	Description	Unit Pkg.
20478	1	10 Amp, Alligator Clip, Nickel Plated, 2" Long	5
16969	2	10 Amp, Red Insulation, 2-1/4" Long	5
16970	2	10 Amp, Black Insulation, 2-1/4" Long	5
16971	2	1 Each of 16969 & 16970	1 Pair
16972	2	30 Amp, Red Insulation, 3" Long	5
16973	2	30 Amp, Black Insulation, 3" Long	5
16974	2	1 Each of 16972 & 16973	1 Pair
16975	2	50 Amp, Red Insulation, 3" Long	5
16976	2	50 Amp, Black Insulation, 3" Long	5
16977	2	1 Each of 16975 & 16976	1 Pair

23152

Black

Insulated Alligator Test Clip
10 AMP

UNIT PACKAGE 5



23153

Charging Test Clip
10 AMP

UNIT PACKAGE 5



WARNING: ALL ITEMS ON PAGE Reproductive Risk & Cancer www.P65Warnings.ca.gov

BATTERY CABLE & TERMINALS



Battery Cable

Bare Copper Standard Conductor, covered with tough black Polyvinyl Chloride insulation.

The thick jacket is easy to strip, resistant to moisture, weather, oil and acids.

Auveco Part No.	Gauge	Stranding	O.D.	Unit Pkg.
13851▲	2/0	133 x 20	.590	25' Roll



Universal Battery Terminal

9948

For Positive & Negative Posts
Cable Range 8 thru 2/0 AWG

UNIT PACKAGE: 2

Marine Battery Terminals

Lead Plated Brass Terminal
Nickel Plated Grade 2 Steel Wing Nut
Zinc Plated Grade 2 Steel Bolt & Nut



8772

For Positive Posts
Stud: 3/8"-16

UNIT PACKAGE: 5

Solderless Battery Cable Terminals

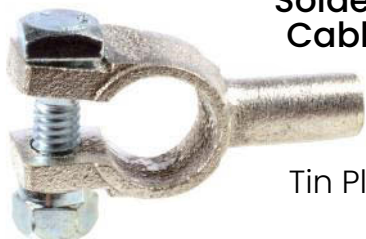

Tin Plated Copper

Auveco Part No.	Cable Size	Post Size	Unit Pkg.
11360	No. 6 AWG	Universal	2
11361	No. 4 AWG	Universal	2
11362	No. 1 AWG	Positive	2
11363	No. 1 AWG	Negative	2
11364	No. 1/0 AWG	Positive	2
11365	No. 1/0 AWG	Negative	2
11366	No. 2/0 AWG	Positive	2
11367	No. 2/0 AWG	Negative	2
15858▲	No. 3/0 AWG	Positive	2



8773

For Negative Posts
Stud: 5/16"-18

UNIT PACKAGE: 5

All Lead Terminal



10808

Zinc Plated Steel
Bolt & Nuts
Stud: 5/16"-18
Universal Positive & Negative

UNIT PACKAGE: 2

Assemble with common hand tools.

All clamps and lugs are made of cast copper • All clamps, lugs and fasteners are tin plated

Engine Ground & Bonding Strap



19499

Replacement for body to engine block straps. Solves light dimming problems by grounding charging system. Also reduces radio noise. Copper braided wire with tin-plated brass ring terminals.

Length: 8"

Gauge: 10

Stud Size Ring Terminal: 5/16" - 3/8"

UNIT PACKAGE: 2

WARNING: Reproductive Harm & Cancer
www.P65Warnings.ca.gov

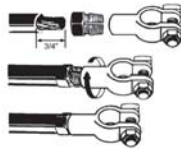
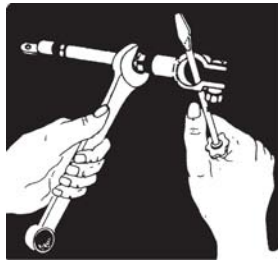

Three Easy Steps

1. Strip 3/4" of insulation from the end of the cable. Insert bared wire into the compression nut.
2. Thread terminal on compression nut.
3. Grip compression nut with wrench and turn the terminal until the compression nut seats. With larger gauges you may want to hold the terminal in a vise



Straight Clamp

Auveco Part No.	Cable Gauge	Description.	Color	Unit Pkg.
15603	4	Pos.	Gray	2
15605	1&2	Pos.	Green	2
15606	1/0	Neg.	Black	2
15607	1/0	Pos.	Black	2
15608	2/0	Neg.	Orange	2
15609	2/0	Pos.	Orange	2

Heavy Wall Copper Lug



Auveco Part No.	Cable Gauge	Hole Size	Color	Unit Pkg.
15618	4	3/8"	Gray	2
15619	1&2	3/8"	Green	2
15620	1/0	3/8"	Black	2
15621	1/0	1/2"	Black	2
15622	2/0	3/8"	Orange	2



Stud/Side Terminal

Auveco Part No.	Cable Gauge	Color	Unit Pkg.
15628	1/0	Black	2

Copper Battery Cable Lugs



Auveco Part No.	Cable Size	Stud Size	Unit Pkg.
22979	6 Ga.	1/4"	10
22982	6 Ga.	5/16"	5
22978	4 Ga.	1/4"	10
22976	4 Ga.	5/16"	10
22987	4 Ga.	3/8"	10
5794	4 Ga.	3/8"	25
22980	2 Ga.	1/4"	5
22977	2 Ga.	5/16"	5
22975	2 Ga.	3/8"	5
22984	1 Ga.	3/8"	5
22983	1/0 Ga.	5/16"	5
22989	1/0 Ga.	3/8"	5
5796	1/0 Ga.	3/8"	25
22986	2/0 Ga.	5/16"	5
22988	2/0 Ga.	3/8"	5
22985	2/0 Ga.	1/2"	5
24087	2/0	5/16"-3/8"	10
11467	2/0 Ga.	1/2"	10
22981	4/0 Ga.	3/8"	5
24098	4/0	1/2"	10

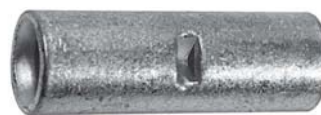

Butt Connector (Double Flared)

Pure Copper with Tin Plating

Applications: Field or shop splicing of battery cables and welding cables.

Auveco Part No.	Cable Size	Length	Unit Pkg.
11729	2/0 Ga.	1-3/4"	5

BATTERY TERMINALS & TOOLS

Photos not actual size



11083
(8917444)
Zinc

Battery Side Terminal Bolt
Thread Size: 3/8"-16
Overall Length: 1-1/8"
GM

UNIT PACKAGE: 10



19199
(12004188)
Zinc

Battery Side Terminal Bolt
Thread Size: 3/8"-16
Overall Length: 1-3/4"
GM

UNIT PACKAGE: 5



13816
Stainless Steel

Battery Hold Down Nuts
Thread Size: 3/8"-16"
Overall Length: 13/16"

UNIT PACKAGE: 4



Battery Terminal Bolt & Nut
Zinc Chromate

Auveco Part No.	Size	Unit Pkg.
3186	5/16"-18 x 1-1/4" Bolt w/Collared Nut	100
8003	5/16"-18 x 1-1/4" Bolt W/Hex Nut	50
14974	5/16"-18 x 1-1/4" Bolt Only	50
14975	5/16"-18 Collared Nut Only	50

WARNING: ALL ITEMS IN CHART Reproductive Harm & Cancer
www.P65Warnings.ca.gov

Heavy Duty Battery Cable Terminal Ends for Stud-Type Batteries

For Auto, Truck, Marine and H.D. Equipment



Single Barrel
Copper/Plated
Stud Size: 3/8

Auveco Part No.	Cable Size	Unit Pkg.
13810	1/0	2
13811	2/0	2



Double Barrel
Copper/Plated
Stud Size: 3/8

Auveco Part No.	Cable Size	Unit Pkg.
13814	2/0	1

Suggested Terminal Assemblies

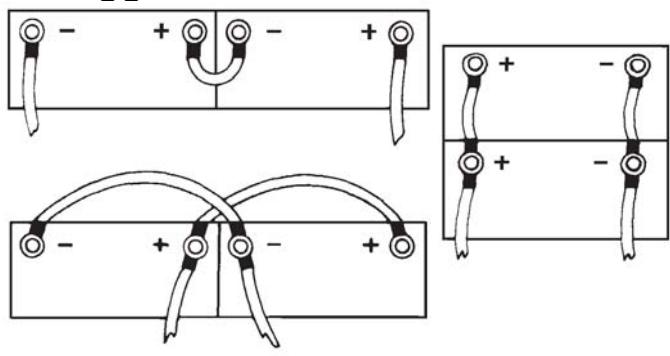

Solder Pellets

- Pre-measured solder pellets provide the proper amount of solder per connection
- Color-coded to industry standards for proper identification
- Flux core aids in preventing dirt and contaminants hindering the solder process
- Provides excellent conductivity and termination without the need of crimping tools
- Used with closed-end battery terminals or lugs

Auveco Part No.	Cable Size	Color	Unit Pkg.
25170	6 Ga.	Gray	15
25163	4 Ga.	Gray	15
25164	2 Ga.	Green	15
25165	1 Ga.	Pink	15
25166	1/0 Ga.	Black	10
25167	2/0 Ga.	Orange	10
25168	3/0 Ga.	Purple	10
25169	4/0 Ga.	Yellow	10

20899

Side Terminal Battery Cleaner



Coil spring cutters polish the battery contacts while the stainless steel brushes clean the cable terminals.

UNIT PACKAGE: 1

Photos not actual size



20898

Battery Brush

Cleans dirt and corrosion from post type battery terminals and cable clamps. Made of heavy duty stainless steel wire. Case is made of high impact plastic that will not weaken in cleaning solutions.

UNIT PACKAGE: 1

3M Vinyl Electrical Tape

Made in U.S.A.



.007" Thick x 3/4" Wide x 60 Ft. Long

16527: UNIT PACKAGE: 5 Rolls

16578: UNIT PACKAGE: 15 Rolls

General purpose vinyl insulating tape with excellent resistance to abrasion, moisture, alkalis, acid, copper corrosion and varying weather conditions. Can be used as a primary electrical insulation for all wire and cable splices rated up to 600 volts.

⚠️ WARNING: Reproductive Risk & Cancer
www.P65Warnings.ca.gov

Wrap & Seal Self-fusing Silicone Tape

- Ideal for applications requiring a water-proof seal and/or high temperatures
- Applications include battery terminals & cable, automotive hose systems, marine connections wire taps & connections and more
- Self-fusing & begins curing immediately (full cure within 24 hours)
- No adhesive residue upon removal
- Alternative to heat shrink tubing
 - Excellent insulator with high dielectric strength: 400 volts per mil
- Operating Temperature: -85°F to 500°F
 - Tensile strength: 700 psi
 - Salt water resistant



Photos not actual size

Auveco Part No.	Size (Width x Length)	Color	Unit Pkg.
25022	1" x 20'	Black	1
25023	1" x 20'	Red	1

CIRCUIT BREAKERS

Automatic Re-Set

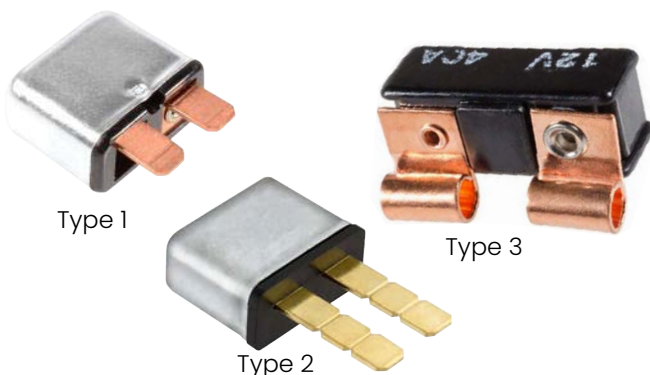

Auveco Part No.	Type	Specifications	Unit Pkg.
15046	1	30 Amps at 12 Volts	5
18518	2	10 Amps at 12 Volts	2
18519	2	15 Amps at 12 Volts	2
18520	2	20 Amps at 12 Volts	2
18521	2	30 Amps at 12 Volts	2
18522	2	40 Amps at 12 Volts	2
15048	3	30 Amps at 12 Volts	5

⚠️ WARNING: ALL ITEMS IN CHART Reproductive Risk & Cancer
www.P65Warnings.ca.gov

HEAT SHRINK TUBING

Made in the U.S.A. • Photos not actual size



Black Thin Wall Heat Shrink Tubing

- 2 to 1 Shrink Ratio
- Cross linked Polyolefin
- Highly Flame Retardant (VW-1)

Auveco Part No.	Size	Pre-Shrink I.D.	Post-Shrink I.D.	Length	Unit Pkg.
18693	3/64"	.046"	.023"	6"	25
18694	1/16"	.063"	.031"	6"	25
18695	3/32"	.093"	.046"	6"	25
18696	1/8"	.125"	.062"	6"	25
18697	3/16"	.187"	.093"	6"	25
18698	1/4"	.250"	.125"	6"	25
18699	3/8"	.375"	.187"	6"	15
18700	1/2"	.500"	.250"	6"	15
18701	3/4"	.750"	.375"	6"	10
18702	1"	1.00"	.500"	6"	10
18703	1-1/2"	1.50"	.750"	6"	5



Adhesive Lined Heat Shrink Tubing

- 4 to 1 Shrink Ratio
- Cross linked, Semi-Rigid Polyolefin Outer Jacket
- Hot-Melt Adhesive Inner Wall adheres to all major types of Wire
- Environmentally Seals & Insulates
- Meets O.E.M. Specs: Ford: ESB M99 D56 AI Chrysler: MS-DB56

Auveco Part No.	Pre-Shrink I.D.	Post-Shrink I.D.	Length	Color	Unit Pkg.
18705	.228"	.050"	3-1/2"	Black	10
18706	.295"	.065"	3-1/2"	Black	10
18707	.429"	.095"	3-1/2"	Black	10
18708	.701"	.175"	3-1/2"	Black	5



Adhesive Lined Dual Wall Self-Sealing Heat Shrink Tubing

- 3 to 1 Shrink Ratio
- Excellent Insulating, Abrasion-Resisting & Strain Relief Properties
- Provides Waterproofing & Environmental Protection

Auveco Part No.	Size	Pre-Shrink I.D.	Post-Shrink I.D.	Length	Color	Unit Pkg.
16665	22-14 Gauge	.188"	.062"	12"	Black	4
16666	12-10 Gauge	.250"	.083"	12"	Black	4
18733	14-10 Gauge	.400"	.150"	6"	Black	4
19102	14-10 Gauge	.400"	.150"	6"	Black	25
18734	14-10 Gauge	.400"	.150"	6"	Red	4
19103	14-10 Gauge	.400"	.150"	6"	Red	25
18735	8-1 Gauge	.750"	.220"	6"	Black	4
19104	8-1 Gauge	.750"	.220"	6"	Black	25
18736	8-1 Gauge	.750"	.220"	6"	Red	4
19105	8-1 Gauge	.750"	.220"	6"	Red	25
18737	2-4/0 Gauge	1.100"	.375"	6"	Black	4
19106	2-4/0 Gauge	1.100"	.375"	6"	Black	25
18738	2-4/0 Gauge	1.100"	.375"	6"	Red	4
19107	2-4/0 Gauge	1.100"	.375"	6"	Red	25

Heavy Wall Heat Shrink Tubing with Sealant

- Rigid heavy wall polyolefin shrink tubing provides the highest strain relief, abrasion and corrosion resistance
- Flame retardant – meets MIL Spec 23053/15 Class 1 requirements
- 3:1 shrink ratio

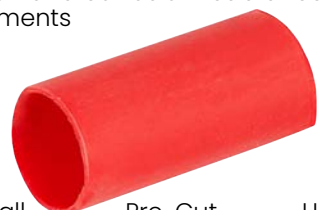

Auveco Part No.	Wire Range	Color	Pre-Shrunk Size	Post-Shrunk I.D.	I.D.	Max. Wall Thickness	Pre-Cut Length	Unit Pkg.
25171	12-4 Ga.	Black	1/2"	0.510"	0.160"	0.080"	1-1/2"	10
25172	12-4 Ga.	Red	1/2"	0.510"	0.160"	0.080"	1-1/2"	10
25173	8-1 Ga.	Black	3/4"	0.750"	0.220"	0.090"	1-1/2"	10
25174	8-1 Ga.	Red	3/4"	0.750"	0.220"	0.090"	1-1/2"	10
25175	2-4/0 Ga.	Black	1"	1.100"	0.375"	0.120"	1-1/2"	10
25176	2-4/0 Ga.	Red	1"	1.100"	0.375"	0.120"	1-1/2"	10

HEAT SHRINK TUBING

Made in the U.S.A. • Photos not actual size



18887

Six inch lengths of black thin wall, cross linked polyolefin, heat shrink tubing in a durable translucent polypropylene box. The tubing has 2:1 shrink ratio.

Heat Shrink Tubing Kit

Auveco Part No.	Qty.	Pre-Shrink Size	Post-Shrink I.D.	I.D.
18697	36	3/16"	.187"	.093"
18698	24	1/4"	.250"	.125"
18699	12	3/8"	.375"	.187"
18700	6	1/2"	.500"	.250"
18701	4	3/4"	.750"	.375"
18702	4	1"	1.00"	.500"

UNIT PACKAGE: 1



Thin Wall Heat Shrink Tubing Disk Packs

- 8ft lengths
- 2:1 shrink ratio
- Polyolefin heat shrink, ideal for light duty applications
- Effective for wire bundling, abrasion resistance and strain relief
 - Highly flame retardant
- Convenient dispenser pack allows for easy storage and cutting - eliminating waste
- Available in 3 colors to NEMA color-code standard to identify connections easily and correctly

Auveco Part No.	Wire Range	Color	Size	Pre-Shrunk I.D.	Post-Shrunk I.D.	Max. Wall Thickness	Unit Pkg.
25016	22-18 Ga.	Red	3/16"	.187"	.093"	.020"	1
25017	16-14 Ga.	Blue	1/4"	.250"	.125"	.025"	1
25018	12-10 Ga.	Yellow	5/16"	.312"	.156"	.025"	1



Clear Adhesive Lined Dual Wall Heat Shrink Tubing

- 3:1 shrink ratio
- Flexible adhesive lined tubing provides a water-tight seal and strain relief
 - Abrasion resistance for connectors & splices
- Clear polyolefin tubing allows for visual inspection of the connection
 - Dielectric strength: 600 volts per mil
- Temperature range: -67°F to 230°F (-55°C to 110°C)

Auveco Part No.	Wire Range	Size	Pre-Shrunk I.D.	Post-Shrunk I.D.	Max. Wall Thickness	Length	Unit Pkg.
25024	20-14 Ga.	3/16"	.187"	.060"	.040"	6"	25
25102							10
25025	18-10 Ga.	1/4"	.250"	.080"	.040"	6"	25
25103							10
25026	12-6 Ga.	3/8"	.375"	.125"	.060"	6"	25
25104							10
25027	8-4 Ga.	1/2"	.500"	.160"	.070"	6"	25
25105							10
25028	4-2/0 Ga.	3/4"	.750"	.250"	.070"	6"	25
25106							5
25029	2-4/0 Ga.	1"	1.00"	.320"	.100"	6"	25
25107							5

FUSE HOLDERS & ACCESSORIES

Photos not actual size

12592
Nylon



Glass Tube Fuse Puller

UNIT PACKAGE: 1

12079
Nylon

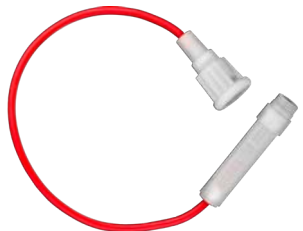

Moulded In-Line Fuse Holder with 8" of 18 Gauge Wire
Use with Auveco 1/4" x 1-1/4" Glass Tube Fuses
Up to and including 20 Amps

UNIT PACKAGE: 3

WARNING: Reproductive Harm & Cancer
www.P65Warnings.ca.gov

11618
Nylon



Fuse Assembly with 30 Amp Fuse Included
12 Gauge Wire

UNIT PACKAGE: 5

WARNING: Reproductive Harm & Cancer
www.P65Warnings.ca.gov

18103



Tests ATO[®] (Blade Type) and Mini-Fuses.
Now you can make sure the fuse is good before installing it.

Also functions as a fuse puller.
40 Amp maximum

UNIT PACKAGE: 1

12359



In-Line Fuse Holder

Accommodates all ATO/ATC fuses from 3-30 Amps
Heavy Duty Hard Shell Construction
10" Loop of 14 Gauge Wire

UNIT PACKAGE: 3

WARNING: Reproductive Harm & Cancer
www.P65Warnings.ca.gov

14055

In-Line Fuse Holder



Accommodates all ATO/ATC fuses from 3-30 Amps Heavy Duty Hard Shell Construction
10" Loop of 12 Gauge Wire

UNIT PACKAGE: 3

WARNING: Reproductive Harm & Cancer
www.P65Warnings.ca.gov

12363

In-Line Fuse Holder



Accommodates all ATO/ATC fuses from 3 thru 20 Amps.
Comes with two 4" 16 Gauge Wire Leads.

UNIT PACKAGE: 5

WARNING: Reproductive Harm & Cancer
www.P65Warnings.ca.gov

20789

In-Line Mini Fuse Holder



30 Amp Maximum
12 Gauge Wire
Use with Auveco Mini Fuses 16351-16360
Replaces Auveco 17648 Fuse NOT Included

UNIT PACKAGE: 3

WARNING: Reproductive Harm & Cancer
www.P65Warnings.ca.gov

FUSES AND FUSE HOLDERS

Photos not actual size

12977

Self-Stripping Fuse Holder

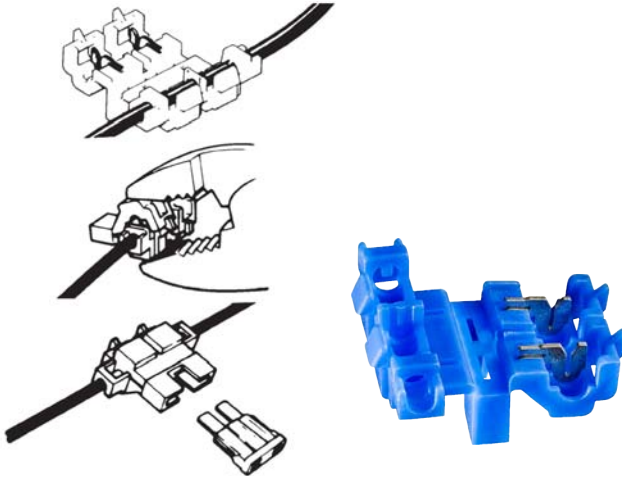

Mates with most plug-in blade type fuses found in late-model domestic and some import cars.
For 18-14 gauge copper wire.

32 volts maximum
20 amp maximum with 14 gauge wire
10 amp maximum with 16 gauge wire
7.5 amp maximum with 18 gauge wire

UNIT PACKAGE: 5

Sealed Fuse Holders For ATM Mini® Fuses



20206

20, 25 & 30 Amp Capacity
10" Long 12 Gauge Cross-Linked
Polyethylene Leads
Fuse NOT Included

UNIT PACKAGE: 1

High Power Sealed Fuse Holder

20320



For ATC & ATO Fuses
40 Amp Capacity
12" Long 10 Gauge 105
Strand
EZ Flex Wire Leads
Fuse NOT Included

UNIT PACKAGE: 1



20207

2-15 Amp Capacity
10" Long 16 Gauge Cross-Linked
Polyethylene Leads
Fuse NOT Included

UNIT PACKAGE: 1

⚠ WARNING: ALL ITEMS ON PAGE Reproductive Risk & Cancer www.P65Warnings.ca.gov

FUSES & FUSE HOLDERS

Photos not actual size

Environmentally Sealed Blade Type Fuse Holder

Also used as Fuel Pump Fuse Holder on GM Vehicles



13686

(GM: 12101917; Delco: PT-189)

UNIT PACKAGE: 1

⚠️ WARNING: Reproductive Harm & Cancer

www.P65Warnings.ca.gov

Electrical system protection for fleets, construction equipment, aircraft service vehicles, outdoor power equipment and marine installations.

Resistant to moisture, salt spray and engine compartment fluids. Withstands 50g physical shock. Operating temperature range from -40° to 125°C.

- Nylon Body with Latching Cap
- Silicone Rubber Seals at Wires and Cap
- 12 Gauge SE/GPT Wire Leads
- 3 to 30 Amp Capacity - Type ATC/ATO Fuses
- 5" Long Wire Leads
- Fuses NOT included

PAL™ (Pacific Auto Link) Fuses



Type 1

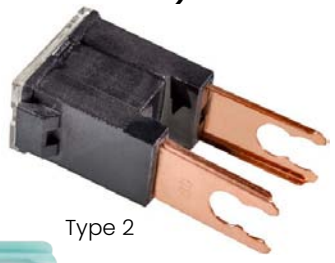

Type 2



Type 4

Auveco Part No.	Type	Amp Rating	Color	Unit Pkg.
20560	1	20	Blue	1
15926	1	30	Pink	1
15927	1	40	Green	1
19294	1	50	Red	3
15928	1	60	Yellow	1
15929	2	30	Pink	1
15930	2	60	Yellow	1
15931	2	80	Black	1
15932	3	30	Pink	1
15933	3	40	Green	1
19296	3	100	Blue	2
20551	4	20	Blue	2
20552	4	30	Pink	2
20553	4	40	Green	2
20554	4	50	Red	2
20555	4	60	Yellow	2

⚠️ WARNING: Reproductive Harm & Cancer

www.P65Warnings.ca.gov



Low Profile JCase Fuses

Auveco Part No.	Amp Rating	Color	Unit Pkg.
21472	20	Blue	3
21473	25	White	3
21474	30	Pink	3
21106	40	Green	3
21475	50	Red	3
21476	60	Yellow	3

⚠️ WARNING ALL ITEMS IN CHART: Reproductive Harm & Cancer

www.P65Warnings.ca.gov

MCASE™ Unslotted Cartridge Fuses



Auveco Part No.	Current Rating (Amps)	Housing Color.	Max Voltage Drop (mV)	Cold Resistance (mΩ)	I ² t (A ² s)	Unit Pkg.
22804	15	Gray	125	5.1	310	3
22805	20	Blue	125	3.4	750	3
22806	25	White	125	2.5	1300	3
22807	30	Pink	120	1.8	970	3
22808	40	Green	120	1.1	1550	3

MCASE™ Slotted Cartridge Fuses



Auveco Part No.	Current Rating (Amps)	Housing Color.	Max Voltage Drop (mV)	Cold Resistance (mΩ)	I ² t (A ² s)	Unit Pkg.
22809	15	Gray	125	5.1	310	3
22810	20	Blue	125	3.4	750	3
22811	25	White	125	2.5	1300	3
22812	30	Pink	120	1.8	970	3
22813	40	Green	120	1.1	1550	3
22814	50	Red	120	0.8	4000	3
22815	60	Yellow	120	0.6	8500	3

⚠️ WARNING: ALL ITEMS IN CHART Reproductive Risk & Cancer www.P65Warnings.ca.gov

Photos not actual size

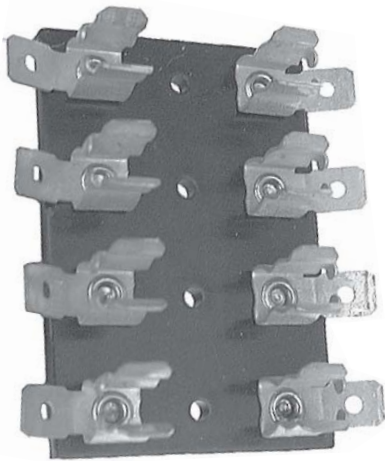

13445

Four Gang Fuse Block

Size: 2-7/16" x 2-15/16" x 3/4"

For use with SFE-20 Amp. fuse or any 3 AG series fuse. Phosphor bronze fuse clips. Brass screws

UNIT PACKAGE: 1



14474

Blade Type Fuse Tap

A quick, easy alternative to direct wiring when tapping the "hot side" of the fuse block. The blade type fuse tap is made of sturdy brass and is engineered for quick connect and disconnect of accessories such as C.B. radios, hand-held lights, etc.

UNIT PACKAGE: 25

Installation can be completed in three steps:

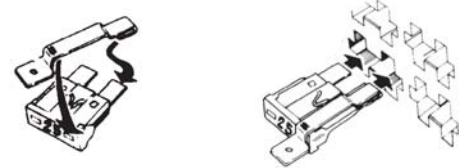

1. Use a test probe to locate the "hot side" of the circuit in the fuse block. Then snap the tap over the corresponding "hot side" blade of the fuse. Insert the fuse into the fuse block.

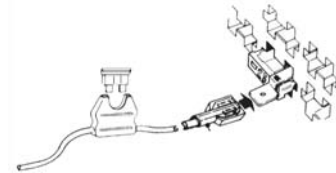

2. Crimp one end of an in-line fuse holder (with the fuse installed) to a fully insulated nylon .250" female quick-connect terminal. Attach the other fuse holder lead to the accessory wire.

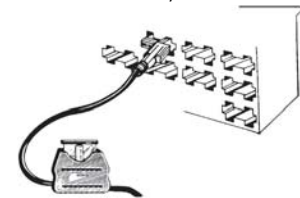

3. Complete the connection by sliding the female quick-connect terminal onto protruding tab of the tap.

Terminal/Junction Blocks



For marine and exposed applications. Brass nickel plated terminal links and binding head terminal screws. Moisture repellent molded ABS base with protective insulator barrier strips. 20 Amp rating.

13446

4 Gang (Circuits)
Size: 3-1/4" x 1-5/16" x 5/8"

UNIT PACKAGE: 1

13447

6 Gang (Circuits)
Size 3-3/8" x 1-1/8" x 9/16"

UNIT PACKAGE: 1



17686

Mini Fuse Blade Type Fuse Tap

"Tapping" fuse blocks equipped with Mini Fuses are no Problem!

Now there's a quick, easy alternative to direct wiring for tapping the "hot side" of mini fuse style fuse blocks. The blade type fuse tap is made of .016" thick sturdy brass with a .187" (3/16") wide tab. It is engineered for quick connect and disconnect of accessories.

UNIT PACKAGE: 50



Installation can be complete in 3 steps:

1. Locate "hot side" of circuit in fuse block with a test probe. Slide the tap onto corresponding "hot side" blade of fuse.

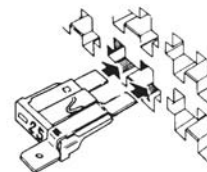

2. Insert the fuse into the fuse block

3. Crimp one end of an in-line fuse holder (with the fuse installed) to the appropriate Auveco female connector 8781 (16-14 Ga.) or 12159 (22-18 Ga.). Attach the other fuse holder lead to the accessory wire.

Slide the female connector onto protruding tab of the tap.

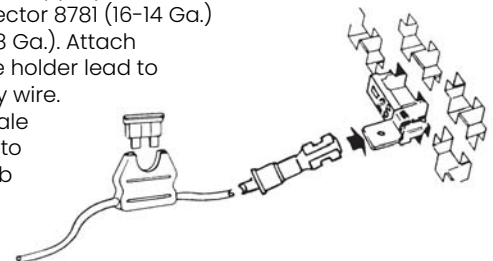

WARNING: ALL ITEMS ON PAGE Reproductive Risk & Cancer www.P65Warnings.ca.gov

ATC®/ATO® (Blade Type) Fuses



Auveco Part No.		Amp Rating	Color
Unit Pkg. 5	Unit Pkg. 25		
12534	12548	3	Violet
12535	12549	4	Pink
12536	12550	5	Tan
12537	12551	7-1/2	Brown
12538	12552	10	Red
12539	12553	15	Blue
12540	12554	20	Yellow
12541	12555	25	White
12542	12556	30	Green
25240	25242	35	Blue-Green
25241	25243	40	Orange

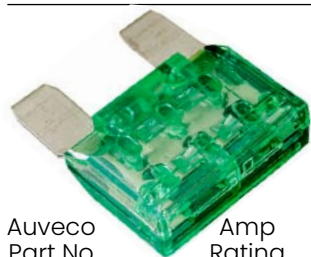

Maxi™ Fuses

Auveco Part No.	Amp Rating	Color	Unit Pkg.
15505	20	Yellow	2
15506	30	Green	2
15507	40	Orange	2
15508	50	Red	2
15509	60	Blue	2



Low Profile Mini Fuses

Auveco Part No.	Amp Rating	Color	Unit Pkg.
21602	5	Tan	5
21603	7.5	Brown	5
21436	10	Red	5
21437	15	Blue	5
21166	20	Yellow	5
21438	25	Clear	5
21604	30	Green	5

Mega® Fuses



Auveco Part No.	Amp Rating	Unit Pkg.
21598	40	2
21599	60	2
21600	80	2
18986	100	2
18987	125	2
18988	150	2
18989	175	2
18990	200	2
22118	250	2
22119	300	2
22120	500	2

⚠ WARNING: ALL ITEMS BUT MEGA FUSES ON PAGE Reproductive Risk & Cancer www.P65Warnings.ca.gov

FUSES



Glass Tube Fuses

Auveco Part No.	Size	Amp	Code	Unit Pkg.
18981	1/4" x 1-1/4"	2	AGC-2	5
17625	1/4" x 1-1/4"	3	AGC-3	5
17626	1/4" x 1-1/4"	5	AGC-5	10
17627	1/4" x 1-1/4"	7.5	AGC-7.5	10
12545	1/4" x 1-1/4"	10	AGC-10	5
12546	1/4" x 1-1/4"	15	AGC-15	5
18982	1/4" x 1-1/4"	20	AGC-20	5
12543	1/4" x 1-1/4"	20	SFE-20	5
18983	1/4" x 1-1/4"	25	AGC-25	5
12544	1/4" x 1-7/16"	30	SFE-30	5
12547	1/4" x 1-1/4"	30	AGC-30	5



Mini® Fuses

Auveco Part No.	Amp Rating	Color	Unit Pkg.
16351	2	Gray	5
16352	3	Purple	5
16353	4	Pink	5
16354	5	Tan	5
16355	7.5	Brown	5
16356	10	Red	5
16357	15	Blue	5
16358	20	Yellow	5
16359	25	White	5
16360	30	Green	5



Micro Fuses 2 Blades

Auveco Part No.	Amp Rating	Color	O.E.M. No.	Unit Pkg.
25244	3	Violet		5
21828	5	Tan	GM: 19209790	5
21829	7.5	Brown	GM: 19209791	5
21830	10	Red	GM: 19209792	5
21831	15	Blue	GM: 19209793	5
21832	20	Yellow	GM: 19209794	5
21833	25	Natural	GM: 19209795	5
21834	30	Green	GM: 19209796	5



Micro Fuses 3 Blades

Auveco Part No.	Amp Rating	Color	O.E.M. No.	Unit Pkg.
25245	3	Violet		2
21749	5	Tan	Ford: DG9Z-14526-N GM: 19209797	2
21750	7.5	Brown	Ford: DG9Z-14526-S GM: 19209798	2
21751	10	Red	Ford: DG9Z-14526-P GM: 19209799	2
21752	15	Blue	Ford: DG9Z-14526-R GM: 19119304	2

LIGHTING

Photos not actual size



5220

Pigtail Connector
Single Large Wire
Lead - 12" Long
For Sockets Housing Single
Contact Lights

UNIT PACKAGE: 10



5225

Pigtail Connector
Three Wire Sealed Beam
12" Long - Molded

UNIT PACKAGE: 10



5226

Universal Signal, Park,
Stop & Tail Lights
For 7/8" to 1-1/8" Hole
Bulb No. 198, 1016,
1034, 1154 & 1157

UNIT PACKAGE: 10



8750

(2974309, 2983540,
6299087 & 8912698)

Signal, Park, Stop & Tail Lights
Bulb No. 1034, 1154 & 1157
GM

UNIT PACKAGE: 5



8754

Weatherproof Signal,
Park, Stop & Tail Lights
For 3/4" Hole
Bulb No. 198, 1016, 1034, 1154 & 1157
GM

UNIT PACKAGE: 5



8755

(2978302)

License Plate, Back-Up
& Instrument Panel Lights
For 1-1/8" Hole
Bulb No. 63, 67, 81, 87, 89, 93,
209, 1003, 1073, 1129, 1133 & 1141
GM

UNIT PACKAGE: 10



8756

(2974309)

Signal, Park, Stop & Tail Lights
For 1-1/8" Hole
Bulb No. 198, 1016, 1034, 1154 & 1157
GM

UNIT PACKAGE: 10



8759

Signal, Park, Stop
& Tail Lights
For 3/4" Hole
Bulb No. 198, 1016,
1034, 1154 & 1157
GM

UNIT PACKAGE: 5



8761

License Plate & Instrument
Panel Lights
For 5/8" Hole
Bulb No. 51, 53, 55, 57 & 57X
Ford

UNIT PACKAGE: 10



8764

Single Contact License Plate Lights
For 7/8"-1-1/8" Holes
Bulb No. 63, 67, 87, 89, 93, 97, 209,
1003, 1073, 1129, 1133, 1141 & 1156

UNIT PACKAGE: 5

WARNING: ALL ITEMS ON PAGE Reproductive Risk & Cancer www.P65Warnings.ca.gov

GM SOCKET ASSEMBLY & HARNESS CONNECTORS

LIGHTING

Photos not actual size



9883
(6298886,
6298892, 6298935;
D0DZ-15A434B)
Side Marker Assembly
Bulb No. 158, 194, 194A
GM & Ford

UNIT PACKAGE: 5

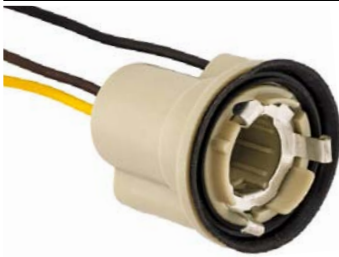

11154
(8903202, 8914822)
Park, Stop & Tail Lights
Bulb No. 1034,
1154 & 1157
GM

UNIT PACKAGE: 1

WARNING: Reproductive Harm & Cancer
www.P65Warnings.ca.gov



11156
(GM: 5963268,
8904437, 8909518;
IHC: 57172C91)
Back-Up & Cornering
Bulb No. 1156
GM & IHC

UNIT PACKAGE: 1

WARNING: Reproductive Harm & Cancer
www.P65Warnings.ca.gov



11157
(4486948;
2983540, 8912698;
6299087)
Signal, Park, Stop
& Tail Lights
Bulb No. 1034,
1154 & 1157
GM & AMC

UNIT PACKAGE: 1

WARNING: Reproductive Harm & Cancer
www.P65Warnings.ca.gov



11439
Headlight & Flasher
For all cars using 3 prong
sealed Headlight Bulbs 4002, 3,
5, 5040, 2, 5400, 2,
40, 421, 6006, 12 & 13
Also fits 2 & 3 Prong Flashers

UNIT PACKAGE: 10

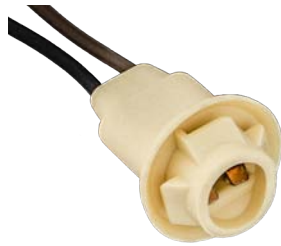

11441
Instrument Panel and
Marker Lights
Bulb No. 158, 194, 194A
GM & Ford

UNIT PACKAGE: 10



11446
(8902487, 8903283,
8907701 & 8909908)
Stop & Tail Lights
Bulb No. 1157
GM

UNIT PACKAGE: 5

WARNING: Reproductive Harm & Cancer
www.P65Warnings.ca.gov



11475
(8903202, 8914822)
Park, Stop & Tail Lights
Bulb No. 1034, 1154 & 1157
GM

UNIT PACKAGE: 5



11476
(8903203, 8914823)
Park, Stop & Tail Lights
Bulb No. 1157
GM

UNIT PACKAGE: 5



12237
(3744750; 1200431,
25015169; C80Z-13711A)
Instrument Panel Socket for 1/2" Hole
Bulb No. 158, 194, 194A
GM, Ford & Chrysler

UNIT PACKAGE: 2



9905
(2496279; 2973932;
3509575; 374985C1)
Instrument Panel Socket for 5/8" Hole
Bulb No. 158, 194, 194A
GM, Chrysler, AMC & International

UNIT PACKAGE: 10

LIGHTING

Photos not actual size

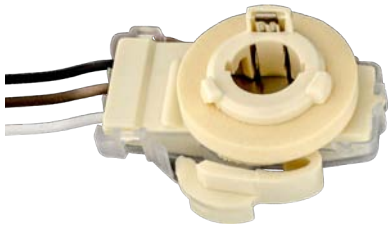

12600
(12003759;
812893)

90° Pigtail &
Socket Assembly
Bulb No. 1016, 1034,
1154 & 1157
GM & AMC

UNIT PACKAGE: 1



13545
(12003758)

Tail Lights
Single Contact
Bulb No. 87, 93 & 1156
GM

UNIT PACKAGE: 1

WARNING: Reproductive Harm & Cancer
www.P65Warnings.ca.gov



13540
(8912750)

Side Marker, License,
Parking & Tail Lights
Bulb No. 158, 194, 194A
GM

UNIT PACKAGE: 1



13546
(12003757)

Signal & Park Lights
Bulb No. 198 & 2057
GM

UNIT PACKAGE: 1

WARNING: Reproductive Harm & Cancer
www.P65Warnings.ca.gov



13541
(3588314)

Side Marker Assembly
Bulb No. 194, 194A
Chrysler

UNIT PACKAGE: 2

WARNING: Reproductive Harm & Cancer
www.P65Warnings.ca.gov



13549
(12001470)

Side Marker, License,
Tail & Stop Lights
Bulb No. 158, 194, 194A
GM

UNIT PACKAGE: 1

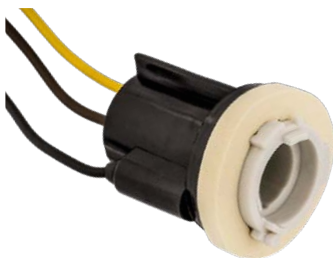

13543
(8919916, 12013813)

Park, Stop &
Tail Lights
Bulb No. 1157
GM

UNIT PACKAGE: 1

WARNING: Reproductive Harm & Cancer
www.P65Warnings.ca.gov

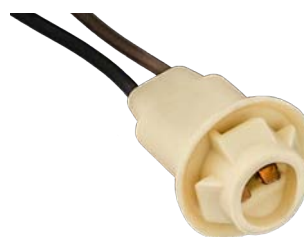

13558
(6298892, 6298886)

Side Marker Assembly
Bulb No. 158, 194, 194A
GM

UNIT PACKAGE: 1



13544
(12003878, 8904251)

Back-up, Cornering
& Turn Signal
Bulb No. 1156
GM

UNIT PACKAGE: 1

WARNING: Reproductive Harm & Cancer
www.P65Warnings.ca.gov



13559

Headlight & Flasher
For all cars using 2 prong
Sealed Headlight
Bulb No. 4001

UNIT PACKAGE: 3

GM SOCKET ASSEMBLY & HARNESS CONNECTORS LIGHTING

Photos not actual size



14918
(12048369)

Headlight Socket Assembly for High-Low 9004 & 9007 Halogen Bulb
GM, Ford & Imports

UNIT PACKAGE: 1



16174

Headlight Socket Assembly For Low Beam 9006 Halogen Bulb
Single Indexing Groove
GM, Ford, AMC & Imports

UNIT PACKAGE: 4



16175
(12101898)

Headlight Socket Assembly For High Beam 9005 Halogen Bulb
Two Indexing Grooves
GM, Ford, AMC & Imports

UNIT PACKAGE: 4



16585
(12083005)

Signal, Park, Stop & Tail Lights Dual Filament Wedge Base
Bulb No. 3057
GM

UNIT PACKAGE: 1



16586
(12083006)

Signal, Park, Stop & Tail Lights Dual Filament Wedge Base
Bulb No. 3057
GM

UNIT PACKAGE: 1

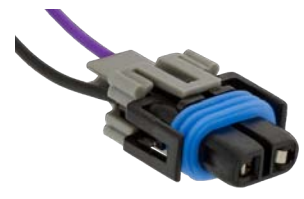

16694
(12043215, 12085498)

Cornering & Fog Light Socket for 881 & H11 Halogen Bulbs
GM

UNIT PACKAGE: 1



17172
(12083680)
Black Shell

Stop, Tail, Turn & Parking Lights Bulb No. 3057 & 3157
GM: 1989-On

UNIT PACKAGE: 1



17173
(12083689)
Ivory Shell

Stop, Tail, Turn & Parking Lights Bulb No. 3057 & 3157
GM 1990-On

UNIT PACKAGE: 1



17174
(12085330)
Brown Shell

Back-Up Lights Bulb No. 2456 & 3156
GM 1990-On

UNIT PACKAGE: 1



17175
(12076946)
Ivory Shell

Stop, Tail, Turn & Parking Lights Bulb No. 3057 & 3157
GM 1988-On

UNIT PACKAGE: 1

WARNING: ALL ITEMS ON PAGE Reproductive Risk & Cancer www.P65Warnings.ca.gov

LIGHTING

Photos not actual size



18525
(Not Supplied by O.E.M.)

**Tail Light
Harness Connector**
GM Full Size Pick-Up
Trucks 1995 - 88

UNIT PACKAGE: 1



18923
(12027133)

Back-Up Lights
GM 1982-On

UNIT PACKAGE: 1

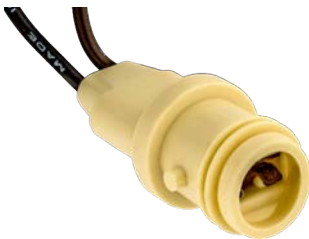

18924
(12083460)

Rear Side Marker Lights
Bulb No. 158, 194, 194A
GM 1985-On

UNIT PACKAGE: 1



21006
(15306157)

White Shell, Natural Insert

**Daytime Running Lights
& Turn Signal**
Bulb No. 3156 & 4156
GM 1999 - On

UNIT PACKAGE: 1



21220
(88987187)

**Headlight Socket
Harness Connector for
H9 Halogen Bulb**
(Auveco Bulb No. BH9)

GM, Audi, Mazda, Mini-Cooper, Porsche,
Volkswagen & Volvo

UNIT PACKAGE: 1



21490

(12102664,88862264,
1U2Z-14S411-YA)

**Fog & Front Lights, Power
Steering & Oil Pressure Switch
Harness Connector**
GM 2005 - 1986
Ford 2004 - 1995
Jeep Eagle 1994

UNIT PACKAGE: 1



22772

(12126453; PT724)

**Dome Lamp, Headlight Actuator,
4WD Lamp & Selector Switch
Repair Harness Connector**
Two 18 ga. 12" Leads
GM Light Duty Trucks
2000 - 1988

UNIT PACKAGE: 1

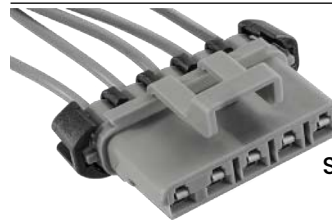

22773

(15305874, PT1015)

**Headlight Actuator &
Switch, Cooling Fan Motor,
Taillight Circuit Board &
Windshield Wiper Motor
Repair Harness Connector**
Five 18 ga. 17" Leads
GM Cars & Light Duty Trucks
2012 - 1991

UNIT PACKAGE: 1



22775

(15306398; PT1451)

**Lamp Socket
Repair Harness Connector**
Three 18 ga. 8" Leads
Buick Rainier 2007 - 2004
Chevrolet SSR, Trailblazer &
GMC Envoy 2009 - 2002
Oldsmobile Bravada
2004 - 2002

UNIT PACKAGE: 1

WARNING: ALL ITEMS ON PAGE Reproductive Risk & Cancer www.P65Warnings.ca.gov

GM SOCKET ASSEMBLY & HARNESS CONNECTORS LIGHTING

Photos not actual size



22931
(12117369; PT2468)
**90° Headlight
Repair Harness Connector**
Three 16 Ga. 8" Leads

Cadillac Escalade 2000 - 1999
Chevrolet Astro, Blazer, C/K1500 - C/K3500,
Express, G10 - G30, Impala, P30, S10,
Suburban & Tahoe 2017 - 1991
GMC C/K1500 - C/K3500, G1500 - G3500, Jimmy,
Safari, Savana, Samona, Suburban,
Typhoon & Yukon 2017 - 1992
Oldsmobile Bravada 1997 -1996

UNIT PACKAGE: 1



23046
(12117025,
88862272, 3U2Z-14S411-UNA)
**Crank Position Sensor, Electric
Brake Module,
Engine Cooling Fan Motor,
Engine Coolant Level Switch &
Lamp Socket Repair Harness
Connector**
Gauge: 16
Three GXL 8" Leads
Sensor:10154687
GM Car & Truck 1990 - On
Ford

UNIT PACKAGE: 1



23014
(145306086, 88860455)
Headlight Socket Assembly
Gauge: 16
Two 6" Leads
For Mini Seal Low Beam 4703
GM 1986 -On

UNIT PACKAGE: 6



23120
(88860530, PT1975)
**Sealed Beam
Socket Assembly**
Gauge: 16
Three GXL 8" Lead
For Lamps H4666 and H6545
GM, Firebird, Blazer 1993 - On
Ford, Probe 1993 - On
Chrysler, Daytona, Laser 1989 - 1991

UNIT PACKAGE: 1



23015
(15306087, 88860454)
Headlight Socket Assembly
Gauge: 16
Two 6" Leads
For Mini Seal High Beam 4701
GM Various Models 1986 - On

UNIT PACKAGE: 6



23127
(12141388, 88986416, LS44)
**Backup, License Plate,
Side Marker, Parking &
Turn Signal Lamp
Socket Assembly**
Gauge: 20
Two TXL 8" Leads
For T-3-1/4 Wedge Base Bulbs
GM Cars & Trucks 1992 - On,
Isuzu Hombre 1996 - On

UNIT PACKAGE: 1

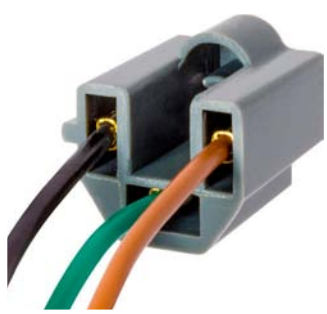

23035
(88860446, 12117333)
**Sealed Beam Headlights
Socket Assembly
With Fiber Optics**
Gauge: 16
Three GPT 8" Leads
GM

UNIT PACKAGE: 1



23130
(12141301, LS39)
**Backup & Fog Lamp
Socket Assembly**
Gauge: 18
Two TXL 8" Leads
For Bulbs 1156, 2056
GM 1992 - 2003

UNIT PACKAGE: 1

WARNING: ALL ITEMS ON PAGE Reproductive Risk & Cancer www.P65Warnings.ca.gov

LIGHTING

Photos not actual size



23131

(15306194, 12141302, LS96, LS40)

Parking, Turn Signal, Tail & Cornering Lamp Socket Assembly

Gauge: 18
Three TXL 8" Leads
For Bulbs 1157, 2057
GM 1992 - 2004

UNIT PACKAGE: 1



23132

(12141493, LS49)

Backup, Parking, Turn Signal, Stop & Tail Lamp Socket Assembly

Gauge: 18
Three TXL 8" Leads
For Bulbs 1157, 2057
GM 1993 - 2005

UNIT PACKAGE: 1



23134

(88953146, PT1555)

Combination Lamp Back Plate Repair Harness Connector

Gauge: 20
Five TXL 8" Lead
Plate: 16532713
GM S/T Trucks 2002 - 2009
Saab 9-7 2005 - 2006
Isuzu Acender 2003 - 2006

UNIT PACKAGE: 1



23136

Socket Assembly
Length: 8"
Used with: PS19W Bulb
Gauge: 18

UNIT PACKAGE: 1



23156

(12102747, PT374, 88862226, PT2307, 13580106, PT2625, 3U2Z-14S411-CJAA, WPT-692)

A/C Pressure Cycling & Backup Lamp Switch, Wheel Speed Sensor, EGR Valve Control & Windshield Waser Pump, Fog Lamp Repair Harness Connector

Gauge: 16
Two GXL 8" Leads
Switch: 25604949
Pump: 22127653
GM Car & Truck 1987 - On,
Ford 2000 - On, SAAB

UNIT PACKAGE: 1

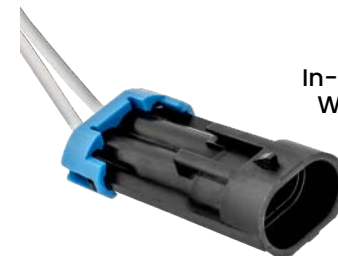

23190

(12167120, PT786, 888622292, PT2373)

In-Line Brakes, Engine, Lamps, Wheel Speed Sensor Repair Harness Connector

Gauge: 18
Two GXL 8" Leads
4 Wheel Drive &
Power Steering
GM Cars & Trucks 1992 - On

UNIT PACKAGE: 1



23229

Hi-Temp Headlight Socket Assembly

Gauge: 14
Three 6" Leads
For Hi-Intensity
(Hi-Heat output) Bulbs
For Bulb 9004 or 9007
Connector rated at 300°C/572°F

UNIT PACKAGE: 2



23230

Hi-Temp Headlight Socket Assembly
Gauge: 14
Two 6" Leads
For Hi-Intensity
(Hi-Heat outpwut) Bulbs
Use with Bulbs 9005,
H10, H12

Connector rated at
300°C/572°F

UNIT PACKAGE: 2

WARNING: ALL ITEMS ON PAGE Reproductive Risk & Cancer www.P65Warnings.ca.gov

GM SOCKET ASSEMBLY & HARNESS CONNECTORS
LIGHTING AND AIR & FUEL

Photos not actual size



23231
Hi-Temp Headlight Socket Assembly
 Gauge: 14
 Leads Length: 6"
 For Hi-Intensity (Hi-Heat output) Bulbs
 For Bulb 9006
 Connector rated at 300°C/572°F

UNIT PACKAGE: 2



23256
 (12085535, PT146, 88862269, PT2350)
In-Line Connector Repair Harness Connector
 Gauge: 18
 Two GPT 8" Leads
 For Interior Lighting, Rear View Mirror, Side Marker Lamp, Van Mirror, Radio Speaker, Lumbar Switch, Etc
 GM Cars & Trucks 1986 - On

UNIT PACKAGE: 1

GM SOCKET ASSEMBLY & HARNESS CONNECTORS
AIR & FUEL



16962
 (Not Supplied by O.E.M.)
 Harness Connector used with GM Mixture Control Solenoid Kits: 17067343, 17067344 and 17111102 on 2 & 4 barrel Rochester Varajet Carburetors.
 GM cars and trucks 1980-On

UNIT PACKAGE: 1

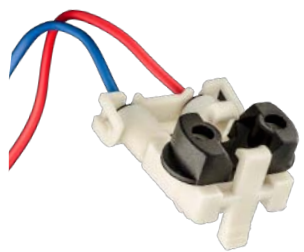

17463
 (12102568)
 Fuel Injector Connector for TBI (Throttle Body Injector) Systems
 All GM (Including Trucks) 1978 - On

UNIT PACKAGE: 1



16968
 (12085491)
Fuel Injector Solenoid Harness Connector
 Fits GM Multi-Port Fuel Injector 1711799 on 2.8 and 3.1 liter engines (27 models) 1986 - On
 Fits Fuel Injectors on Ford, Chrysler & Imports (Bosch)

UNIT PACKAGE: 1



18320
 (12101856)
Air Switch Valve Harness Connector
 GM 1993-91

UNIT PACKAGE: 1



17114
 (12085496)
Direct Ignition Throttle Body Injection Pigtail
 GM 1987-On

UNIT PACKAGE: 2



18918
 (12085506)
Fuel Injection Idle Air Control Valve, Stoplight Switch & Torque Converter Clutch Valve Harness Connector
 GM 1985 - On

UNIT PACKAGE: 1



18925
 (25117765)
E.F.I. Fuel Pump Harness Connector
 GM with Fuel Pump in Gas Tank 1995-88

UNIT PACKAGE: 1

⚠ WARNING: ALL ITEMS ON PAGE Reproductive Risk & Cancer www.P65Warnings.ca.gov

AIR & FUEL

Photos not actual size



22774

(15306349, PT1402)

**Fuel Pump & Sender
Repair Harness Connector**
Four 20 ga. 12" Leads
Chevrolet Cobalt, Malibu, S-10,
GMC Sonoma &
Pontiac G5 2008 - 2000

UNIT PACKAGE: 1



23020

(12126487, PT757, 19115673,
PT2203, 19257375, PT2605,
88862215, PT2296,
3U2Z-14S411-SCA, WPT-704,
8U2Z-14S411-DA, WPT-915)

**Distributor Module
Repair Harness Connector**

Gauge: 18
Four TXL 8" Leads
Module: 1987466, GM 1985 - 1992
Ignition Coil: 12558693,
Lt. Duty GM Trucks 1999 - 2007
Crank Sensor: 25526124, 25535481, 25526122
GM w/2.8 Eng. 1985 - On, w/3.8 1988 - On
IAC Valves, GM 1987 - 2007 & Chrysler 1986 - 1995
Door jamb switch, Ford 2003 - 2007

UNIT PACKAGE: 1

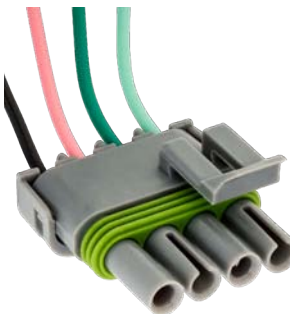

23025

(Not Available By OEM)

**Idle Speed Control
Repair Harness Connector**

Gauge: 18
Four GXL 12" Leads
GM V6 - V8
w/Carburetors 1981 - 1987

UNIT PACKAGE: 1



23032

(12085491, PT113,
12085490, PT112,
88862303, PT2384)

**Fuel Injector
Repair Harness Connector**

Gauge: 18
Two 8" GXL Leads
Lucas & Bosch Injectors
w/External Spring Clip Retainer
Domestic & Import Vehicles

UNIT PACKAGE: 1



23096

(88861107, PT2164)

**Fuel Injector Plug
Repair Harness Connector**
Gauge: 18
Two 8" SXL Leads
Lucas & Bosch Injectors
w/External Spring Clip Retainer
Domestic & Import Vehicles

UNIT PACKAGE: 1



23135

(5183448AA)

**Fuel Injector &
ABS Sensor
Repair Harness Connector**

Gauge: 20
Two TXL 12" Leads
Chrysler, Dodge & Jeep 2001 - On
Mitsubishi 2007 - On
GM & Ford

UNIT PACKAGE: 1



23156

(12102747, PT374, 88862226, PT2307, 13580106, PT2625,
3U2Z-14S411-CJAA, WPT-692)

**A/C Pressure Cycling & Backup
Lamp Switch, Wheel Speed Sensor,
EGR Valve Control & Windshield
Waser Pump, Fog Lamp
Repair Harness Connector**

Gauge: 16
Two GXL 8" Leads
Switch: 25604949
Pump: 22127653
GM Car & Truck 1987 - On, Ford 2000 - On, SAAB

UNIT PACKAGE: 1



23181

(12085485, PT107, 88862267,
PT2348, 3U2Z-14S411-NZA,
3U2Z-14S411-SFA, WPT-494,
WPT-564, 5019910AA)

**Backup Lamp Switch,
Speed Sensor, IAC Value
Repair Harness Connector**

Gauge: 12
Two SXL 8" Leads
Switch: 23049569, D2220A
GM Cars & Trucks 1971 - On, Ford Mustang 2001-2014

UNIT PACKAGE: 1

WARNING: ALL ITEMS ON PAGE Reproductive Risk & Cancer www.P65Warnings.ca.gov

GM SOCKET ASSEMBLY & HARNESS CONNECTORS

AIR & FUEL

Photos not actual size



23221
 (12101858, 13585860, PT250, PT2784)
Vapor Canister Purge Solenoid Repair Harness Connector
 Gauge: 16
 Two TXL 8" Leads
 GM Cars & Lt. Truck 1990 - On Saturn 2007 - 2009

UNIT PACKAGE: 1



24202
 (88988963, PT2183, CU2Z-14S411-ARA, WPT-1302)
Fuel Injector, Knock, Cam Crank, Coolant Temp Sensor Repair Harness Connector
 Gauge: 14
 Two TXL 8" Leads
 GM 2004 - 2014
 Ford 2010 - 2016

UNIT PACKAGE: 1

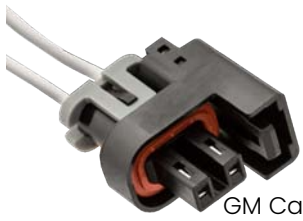

23227
 (88988814, PT2135)
Fuel Injector Repair Harness Connector
 Gauge: 20
 Two TXL 8" Leads
 GM Cars & Lt Duty Trucks 1999 - 2008

UNIT PACKAGE: 1



25160
 (CU2Z-14S411-UA; WPT-1277; 90980-11875)

Variable Timing Solenoid, Fuel Injector, Knock Sensor Repair Harness Connector
 2-18 ga. 8" Leads
 Acura 2017- 2005; Chevrolet Prism 2002 - 1998; Ford; Lincoln 2017 - 2011; Honda 2016 -2005; Isuzu 2017 - 2004 Mercedes E-320 2000; Pontiac Vibe 2010 - 2003; Scion 2015 - 2008; Suzuki 2013 - 2009; Toyota 2017 - 1998

UNIT PACKAGE: 1

GM SOCKET ASSEMBLY & HARNESS CONNECTORS

CHARGING & STARTING

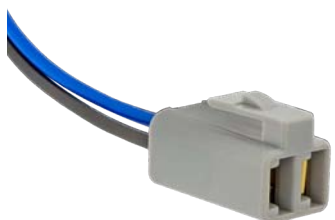

11442
 (2977373)
Alternator Harness Connector with External Voltage Regulators
 GM 1977-62

UNIT PACKAGE: 10



13547
 (2977373)
Alternator Extender Harness Connector with Female Connector
 GM 1974-62

UNIT PACKAGE: 2

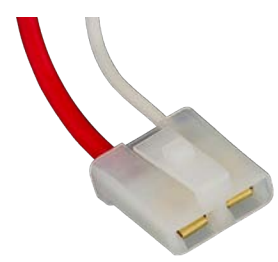

11443
 (6294493)
Alternator Harness Connector with Transistorized Alternators
 GM

UNIT PACKAGE: 10

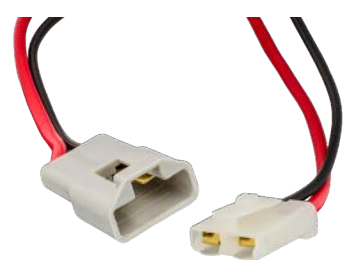

13548
 (6294493)
Alternator Extender Harness Connector with Female Connector
 GM 1971-On

UNIT PACKAGE: 2



11444
Voltage Regulator Pigtail
 GM

UNIT PACKAGE: 10



17109
 (12085525, 12085527, 12085528, 12101895, 12117361)
3 Wire Alternator Harness Connector
 Two 18 gauge and one 12 gauge leads
 Can be used to replace two wire and single wire harness connectors by taping (do NOT cut) the appropriate unused leads.
 GM 1986-On

UNIT PACKAGE: 1

⚠ WARNING: ALL ITEMS ON PAGE Reproductive Risk & Cancer www.P65Warnings.ca.gov

GM SOCKET ASSEMBLY & HARNESS CONNECTORS

CHARGING & STARTING AND HEATING & AIR CONDITIONING

Photos not actual size



22776

(88953267, PT1616)

Alternator, Door Jamb & Brake Pressure Switch, Washer Pump & Door Lock Actuator Repair Harness Connector
Two 16 Ga. 5" Leads

Chevrolet Equinox 2007 - 2005
Hummer H2 2009 - 2003
Chrysler Cars & Light Duty Trucks 2018 - 1997
Jeep 2007 - 1998

UNIT PACKAGE: 1



23124

(12085537, PT147, 15306009, PT1136, 15324824, 88862284, PT2365)

Neutral/Park & Rear Wiper Switch, Alternator, Wheel/Vehicle Speed Sensors, Repair Harness Connector

Gauge: 18
Four GXL 8" Leads
Switch: 1994363, 1994335
GM 1986 - On

UNIT PACKAGE: 1



23001

Alternator Harness Connector
Length: 8"
Gauge: 14
2 Wires

UNIT PACKAGE: 1

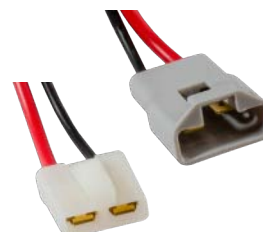

23141

(88861073, 89057714, PT2064, PT2145)

Alternator Leads Extender Repair Harness Connector with Built-in Voltage Regulator

One 12 Gauge
One 16 Gauge
Two 11" Leads
GM Cars & Trucks

UNIT PACKAGE: 12



23027

(88860484, 88987962, PT1929, PT1742)

Voltage Regulator Repair Harness Connector
Three 18 Gauge
One 12 Gauge
GXL 8" Leads

All Models with Internal Regulators
Regulators: 1116411 & 1116408
GM 1986 - On

UNIT PACKAGE: 1



23211

(89046837, PT2057, 13585849, PT2787)

Alternator Repair Harness Connector
Gauge: 14

Two TXL 8" Leads
GM 2004 - On

UNIT PACKAGE: 1

GM SOCKET ASSEMBLY & HARNESS CONNECTORS

HEATING & AIR CONDITIONING



16514

(12085503)

Replacement Harness Connector used on GM V-5 Air Conditioning Compressor Pressure Cut-off Switches.
Fits GM low Pressure Switch 6551946 and others.
Index slot is at three o'clock position
Features two 9" long 18 gauge wire leads

UNIT PACKAGE: 1



22773

(15305874, PT1015)

Headlight Actuator & Switch, Cooling Fan Motor, Taillight Circuit Board & Windshield Wiper Motor Repair Harness Connector

Five 18 ga. 17" Leads
GM Cars & Light Duty Trucks 2012 - 1991

UNIT PACKAGE: 1



17113

(12101937)

A.C. Compressor Clutch Harness Connector
GM Cars & APV 1989-On

UNIT PACKAGE: 1

WARNING: ALL ITEMS ON PAGE Reproductive Risk & Cancer www.P65Warnings.ca.gov

GM SOCKET ASSEMBLY & HARNESS CONNECTORS HEATING & AIR CONDITIONING

Photos not actual size



23017

(12085521, PT131,
88862212, PT2293)

A/C Compressor High Pressure Cut-Off Switch Repair Harness Connector
Gauge: 18
Two 7" Leads
Index Slot at 1 o'clock
GM all w/V-5
Compressor 1993 - 1996

UNIT PACKAGE: 1



23018

(12085503, PT124,
88862211, PT2292)

A/C Compressor Low Pressure Switch Repair Harness Connector
Gauge: 18
Two 7" Leads
Index Slot at 3 o'clock
GM all w/V-5
Compressor 1993 - 1996

UNIT PACKAGE: 1



23046

(12117025, PT420,
88862272, PT2353
3U2Z-14S411-UNA, WPT-763)

Crank Position Sensor, Electric Brake Module, Engine Cooling Fan Motor, Engine Coolant Level Switch & Lamp Socket Repair Harness Connector

Gauge: 16
Three GXL 8" Leads
Sensor:10154687
GM Car & Truck 1990 - On Ford

UNIT PACKAGE: 1



23146

(12101907, PT179,
88862248, PT2329)

A/C Compressor Clutch Repair Harness Connector with Diode
Gauge: 18
Two GXL 6" Leads
GM Vehicles 1983 - 1989

UNIT PACKAGE: 1

WARNING: Reproductive Harm & Cancer
www.P65Warnings.ca.gov



23156

(12102747, PT374, 88862226, PT2307, 13580106, PT2625,
3U2Z-14S411-CJAA, WPT-692)

A/C Pressure Cycling & Backup Lamp Switch, Wheel Speed Sensor, EGR Valve Control & Windshield Waser Pump, Fog Lamp Repair Harness Connector

Gauge: 16
Two GXL 8" Leads
Switch: 25604949
Pump: 22127653
GM Car & Truck 1987 - On, Ford 2000 - On, SAAB

UNIT PACKAGE: 1

WARNING: Reproductive Harm & Cancer
www.P65Warnings.ca.gov

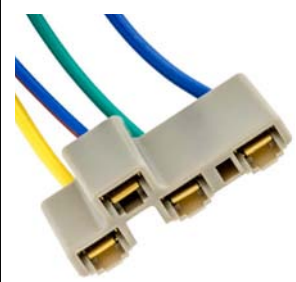

23158

(12102675, PT342,
88862233, PT2314)

Heater Resistor Repair Harness Connector

Two 16 Gauge
Two 18 Gauge
GXL 8" Leads
Resistor: 526897, 10039426
GM 1977 - 1992

UNIT PACKAGE: 1

WARNING: Reproductive Harm & Cancer
www.P65Warnings.ca.gov

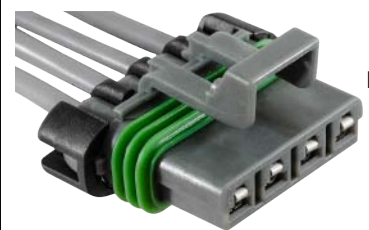

23164

Blower Resistor Harness Connector
Length: 8"
Gauge: 12
4 Wires

UNIT PACKAGE: 1

WARNING: Reproductive Harm & Cancer
www.P65Warnings.ca.gov

IGNITION

Photos not actual size



17112

Not Supplied By O.E.M.

Distributor Module Pigtail

Used on GM distributor module 1987466 on 6 cylinder 2.8 engines 1985-On

UNIT PACKAGE: 1



18867

(12101880)

Direct Ignition Harness Connector

GM
1987-On

UNIT PACKAGE: 1



22935

(19179280; PT2427)

Cam/Crank Sensor, Ignition Coil, MAP Sensor, Oil Pressure Switch & Throttle Position Sensor Repair Harness Connector

Three 22 Ga. 8" Leads

Cadillac DeVille, Eldorado, Fleetwood & Seville 1988 - 1980, Chevrolet Express 1500-3500 & Silverado 1500, GMC Savanna 1500-3500, Silverado 1500 2014 - 2007, Pontiac Gran Prix 1984, Acura CL, MDX, RDX, RL, RSX, TL & TSX 2012 - 2001, Honda Accord, Civic, CR-V, Element, Fit, Insight, Odyssey, Pilot & Ridgeline 2011 - 2003, Scion FR-S, iA 2016 - 2013, Toyota Yaris 2018 - 2017

UNIT PACKAGE: 1



23020

(12126487, PT757, 19115673, PT2203, 19257375, PT2605, 88862215, PT2296, 3U2Z-14S411-SCA, WPT-704, 8U2Z-14S411-DA, WPT-915)

Distributor Module Repair Harness Connector

Gauge: 18

Four TXL 8" Leads

Module: 1987466, GM 1985 - 1992

Ignition Coil: 12558693,

Lt. Duty GM Trucks 1999 - 2007

Crank Sensor: 25526124, 25535481, 25526122

GM w/2.8 Eng. 1985 - On, w/3.8 1988 - On

IAC Valves, GM 1987 - 2007 & Chrysler 1986 - 1995

Door jamb switch, Ford 2003 - 2007

UNIT PACKAGE: 1

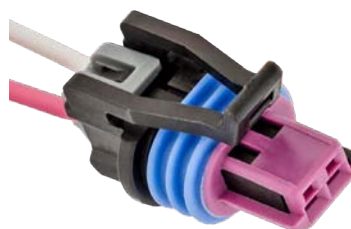

23021

Distributor Module & Horn Repair Harness Connector

Gauge: 18

Two TXL 8" Leads

Module: 1987466

Horns: 5269098,

5269099 & 5269103

GM w/2.8 (6 cyl.) Eng. 1985 - On

Chrysler 1991 - 1995

UNIT PACKAGE: 1



23053

(15305942, PT1174, 88987184, PT1627, 88862287, PT2368)

Crank Sensor & Ignition Coils Repair Harness Connector

Gauge: 18

Four TXL 8" Leads

Sensors: 12537111, 24500988, 24501417, 25533327

Coils: 10457730, 12558693, 12570616,

12573190, 19005218

GM 1988 - On

UNIT PACKAGE: 1

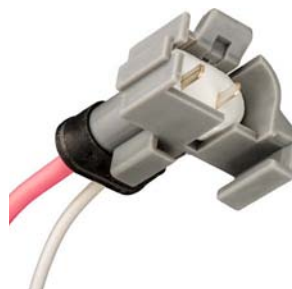

23079

(12101896, PT166, 88862221, PT2302)

Ignition Coil Repair Harness Connector

One 18 Gauge

One 12 Gauge

GXL 8" Lead

Fits Coils 1115315 & 1115317

GM 1985 - On

UNIT PACKAGE: 1



23080

(88860464, PT1909)

Ignition Coil Repair Harness Connector

Gauge: 18

Two GXL 8" Leads

Fits Coils: 1115315 & 1115317

GM 1985 - On

UNIT PACKAGE: 1

WARNING: ALL ITEMS ON PAGE Reproductive Risk & Cancer www.P65Warnings.ca.gov

**GM SOCKET ASSEMBLY & HARNESS CONNECTORS
HEATING & AIR CONDITIONING AND IGNITION**

Photos not actual size

23160

**Ignition, Cam, Crank,
Map, TPS Sensor Harness
Connector**
Length: 8"
Gauge: 14
3 Wires



UNIT PACKAGE: 1

23275
(12167658)

**H.E.I. Distributor Power &
Tach Feed Repair
Harness Connector**
Contains 2 Harnesses
One 14 Gauge
One 12 Gauge
GXL 12" Leads
GM 1974 - 1990

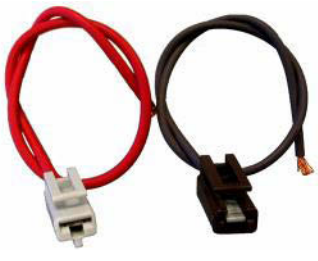

UNIT PACKAGE: 1

25210

(88986460; PT2048)

**Canister Vent Solenoid, Ignition
Coil, EGR Solenoid, High Mount
Stop Light, Crank Position
Sensor & Variable Valve Timing
Solenoid Repair Harness
Connector**
2-16 Ga.
8" Wire Leads



GM Camaro, Malibu 2013 - 2005; Equinox 2010 - 2005,
Nova 1988 - 1986, Metro 2001 - 1998,
Tracker 2004 - 2001, Acadia 2010 - 2007,
Yukon 2009 - 2008, Solstice, Torrent 2009 - 2006,
Vibe 2005 - 2003; Saturn Outlook, Relay 2007,
Sky 2009 - 2007; Hyundai Accent 2013 - 2005,
Elantra 2010 - 2002, Equus 2016 - 2011,
Genesis 2016 - 2009, Santa Fe, Tuscon 2015 - 2010,
Sonata 2014 - 2005, Tiburon 2013 - 2003,
Veloster 2013 - 2012; Kia Borrego 2011 - 2009,
Forte 2015 - 2010, K900 2017 - 2015,
Magentis 2009 - 2008, Optima 2015 - 2006,
Rio 2014 - 2005, Rondo 2014 - 2007,
Sorento 2015 - 2011, Soul 2013 - 2010,
Spectra 2009 - 2004, Sportage 2016 - 2004;
Lexus ES300 2003 - 1999, ES330 2006 - 2004, ES350,
GS450h, LS460, RX350 2013 - 2007, GS400 2000 - 1998,
GS430 2007 - 2001, GS460 2011 - 2008, GX460, RX450h
2013 - 2010, GX470 2007 - 2003,
HS250h 2012 - 2010, IS F 2014 - 2008,
IS250, 2013 - 2006, IS300 2005 - 2001,
LS400 2000 - 1999, LS430 2006 - 2001, LS600h, LX570
2013 - 2008, LX470 2007 - 1998,
RX300 2003 - 1999, RX330 2006 - 2004,
RX400h 2008 - 2006, SC300, SC400 2000 - 1992, SC430
2010 - 2002; Scion IQ 2015 - 2012,
tC 2010 - 2005, xA 2006 - 2004, xB 2015 - 2004; Subaru
Impreza 2005 - 1998, Legacy 2004 - 1998, Suzuki
Sidekick 1998 - 1996, Swift 2001 - 1998,
XL-7 2009 - 2006; Toyota 4Runner 2010 - 1988,
Avalon 2016 - 2000, Camry 2011 - 2002,
Corolla 1989 - 1986; Paseo 1994 - 1992,
Pickup 1995 - 1988, Solara 2008 - 2004,
T100 1998 - 1993, Tacoma 2016 - 1995, Tundra
2016 - 2005, Venza 2013 - 2009, Yaris 2014- 2006

UNIT PACKAGE: 1

**GM SOCKET ASSEMBLY & HARNESS CONNECTORS
MISCELLANEOUS**

16967
(12101906)

Heater Blower connector
pigtail on GM 1985-On.
Can also be used as
an ATO/ATC Fuse Holder.
Features two 8" long 12 gauge
GXL wire leads.



UNIT PACKAGE: 1

WARNING: Reproductive Harm & Cancer
www.P65Warnings.ca.gov

17111
(12116958)

Horn Harness Connector
Fits Horns 1999160, 1999161,
10456327 and 10456328
GM 1988-On

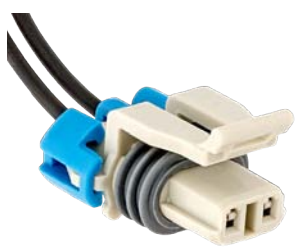

UNIT PACKAGE: 1

WARNING: Reproductive Harm & Cancer
www.P65Warnings.ca.gov

MISCELLANEOUS

Photos not actual size

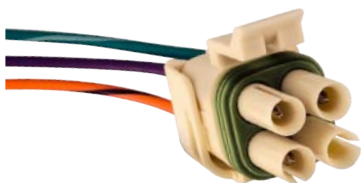

17199

(12085533)

**Transmission
Converter Clutch
Harness Connector**

3 Wires (Cavity "C" is not wired)
GM 1990-84

UNIT PACKAGE: 1



21212

(88988609)

**Window Motor Regulator
Harness Connector**

Two 12 Gauge
10" Long Leads
GM 1995 - On

UNIT PACKAGE: 1



22772

(12126453; PT724)

**Dome Lamp, Headlight Actuator,
4WD Lamp & Selector Switch
Repair Harness Connector**

Two 18 ga. 12" Leads
GM Light Duty Trucks
2000 - 1988

UNIT PACKAGE: 1



22773

(15305874; PT1015)

**Headlight Actuator &
Switch, Cooling Fan Motor,
Taillight Circuit Board &
Windshield Wiper Motor
Repair Harness Connector**

Five 18 ga. 17" Leads
GM Cars & Light Duty Trucks 2012 - 1991

UNIT PACKAGE: 1



22776

(88953267; PT1616)

**Alternator, Door Jamb &
Brake Pressure Switch,
Washer Pump & Door Lock
Actuator Repair
Harness Connector**

Two 16 Ga. 5" Leads

Chevrolet Equinox 2007 - 2005
Hummer H2 2009 - 2003
Chrysler Cars & Light Duty Trucks 2018 - 1997
Jeep 2007 - 1998

UNIT PACKAGE: 1

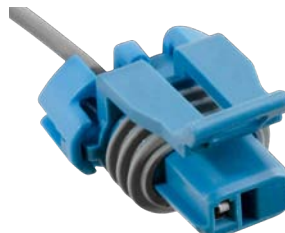

22932

(12126458; PT728)

**Engine Coolant Temp Sensor,
A/C Compressor &
Master Cylinder Reservoir
Repair Harness Connector**

One 18 Ga. 8" Lead

Cadillac Escalade 2000 - 1999
Chevrolet Astro, Blazer, C/K1500 - C/K3500,
Express, G10 - G30, Impala, P30, S10,
Suburban & Tahoe 2005 - 1991
GMC C/K1500 - C/K3500, G1500 - G3500,
Jimmy, Safari, Savana, Sonoma, Suburban,
Typhoon & Yukon 2005 - 1992
Oldsmobile Bravada 1997 -1996

UNIT PACKAGE: 1

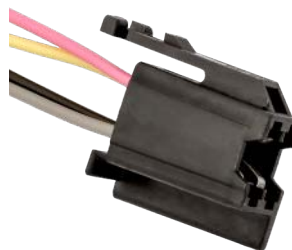

23012

(12102601, PT287)

**Radio Power Supply
Repair Harness Connector**

Four 18 Gauge Wires
GM 1978 - On

UNIT PACKAGE: 6

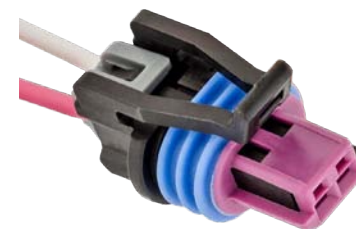

23021

**Distributor Module &
Horn Repair Harness
Connector**

Gauge: 18

Two TXL 8" Leads
Module: 1987466
Horns: 5269098,
5269099 & 5269103

GM w/2.8 (6 cyl.) Eng. 1985 - On
Chrysler 1991 - 1995

UNIT PACKAGE: 1



23038

(12101914, 12107779,
PT186, PT407,
88862236, PT2317)

**Window Lift Motor &
Door Lock Actuator
Repair Harness Connector**

Gauge: 12

Two GPT 8" Leads
GM Vehicles 1979 - On

UNIT PACKAGE: 1

WARNING: ALL ITEMS ON PAGE Reproductive Risk & Cancer www.P65Warnings.ca.gov

GM SOCKET ASSEMBLY & HARNESS CONNECTORS

MISCELLANEOUS

Photos not actual size



23046

(12117025, PT420,
88862272, PT2353
3U2Z-14S411-UNA, WPT-763)

**Crank Position Sensor, Electric
Brake Module,
Engine Cooling Fan Motor,
Engine Coolant Level Switch &
Lamp Socket Repair Harness
Connector**

Gauge: 16
Three GXL 8" Leads
Sensor:10154687
GM Car & Truck 1990 - On
Ford

UNIT PACKAGE: 1

WARNING: Reproductive Harm & Cancer
www.P65Warnings.ca.gov



23050

(12117277, PT1489,
88862283, PT2364)

**Front Axle 4WD Actuator
Repair Harness Connector**
Actuator # 26060073
For replacing original actuator

Gauge: 18
Five GXL Leads
GM Trucks 1997 - On

UNIT PACKAGE: 1



23071

(3U2Z-14S411-LKA,
WPT-615, 5017112AA)

Data Link for OBDII Harness Connector Kit

Contents: 1-Connector (12110250), 2 Locks,
Six 16 Ga., Six 20 Ga. & Two 22 Ga.
TXL 8" Leads

All Cars & Lt Duty Trucks
Built in the U.S. 1995 - On

UNIT PACKAGE: 1

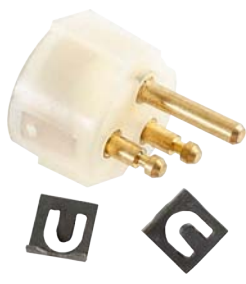

23117

**Tailgate Harness Connector
For Lock Assembly 6259467**

GM Station Wagon
with Power Tailgate
Use Old Lock Cylinder.
No Recoding of Lock or
Extra Keys necessary
Contains: Connector &
2 Retainers
GM Suburban & Blaze 1960 - On

UNIT PACKAGE: 1



23156

(12102747, PT374, 88862226, PT2307, 13580106, PT2625,
3U2Z-14S411-CJAA, WPT-692)

**A/C Pressure Cycling & Backup
Lamp Switch, Wheel Speed Sensor,
EGR Valve Control & Windshield
Washer Pump, Fog Lamp
Repair Harness Connector**

Gauge: 16
Two GXL 8" Leads
Switch: 25604949
Pump: 22127653
GM Car & Truck 1987 - On,
Ford 2000 - On, SAAB

UNIT PACKAGE: 1

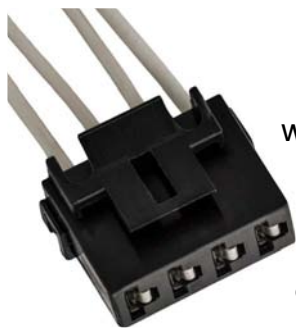

23157

(12085487, PT109,
88862268, PT2349)

**Wiper Motor, Windshield Wiper
& Window Switch
Repair Harness Connector**

Gauge: 18
Four GXL 8" Leads
Wiper Motor 22062912
GM Cars & Trucks 1984 - 1995

UNIT PACKAGE: 1

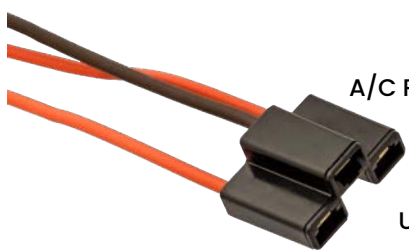

23165

**A/C Power Servo Harness
Connector**

Gauge: 12
3 Wires

UNIT PACKAGE: 12

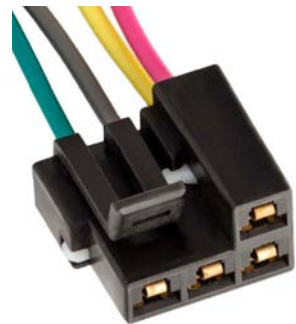

23179

(12085530, PT140,
88862257, PT2338)

**Windshield Wiper Motor
Repair Harness Connector**

Gauge: 18
Four GPT 8" Leads
GM Vehicles 1984 - 1989

UNIT PACKAGE: 1

MISCELLANEOUS

Photos not actual size



23190

(12167120, PT786,
88862292, PT2373)

**In-Line Brakes, Engine, Lamps,
Wheel Speed Sensor Repair
Harness Connector**

Gauge: 18
Two GXL 8" Leads
4 Wheel Drive &
Power Steering
GM Cars & Trucks 1992 - On

UNIT PACKAGE: 1

WARNING: Reproductive Harm & Cancer
www.P65Warnings.ca.gov



23265

(12101888, PT159,
88862295, PT2376)

**Window Lift Motor
Repair Harness
Connector**

Early Design
Window Motors
Gauge: 12
Two GXL 8" Leads
GM 1990 - 1995

UNIT PACKAGE: 1

WARNING: Reproductive Harm & Cancer
www.P65Warnings.ca.gov



23256

(12085535, PT146,
88862269, PT2350)

**In-Line Connector Repair
Harness Connector**

Gauge: 18
Two GPT 8" Leads
For Interior Lighting,
Rear View Mirror,
Side Marker Lamp,
Van Mirror, Radio Speaker,
Lumbar Switch, Etc
GM Cars & Trucks 1986 - On

UNIT PACKAGE: 1

WARNING: Reproductive Harm & Cancer
www.P65Warnings.ca.gov



23437

(3U2Z-14S411-JFA,
3U2Z-14S411-EPAA, WPT-288,
WPT-719, 88860557, PT2002)

**Windshield Washer Pump
Repair Harness Connector**

Gauge: 16
Two GPTL 8" Leads
Pump: E4TZ-17664-A, E5TZ-17664-B,
F19Z-17664-A, E6S3-17664-CA,
22048650 & 22049373
Ford Car & Truck 1984 - On
GM Cars & Lt. Duty Trucks 1982 - 1992

UNIT PACKAGE: 1



25211

(12125641; PT553)
**Wiper Motor & Power Seat
Repair Harness Connector**

5-16 Ga.
8" Wire Leads
GM Escalade 2000 - 1999, Astro 2005 - 1994,
Blazer 2005 - 1992, Pickups 2002 - 1988, G10-G30,
G1500-G3500 Van 1996 - 1992, Lumina 1996 - 1990, P30
1994 - 1991, S10, S10 Blazer 1999 - 1994, Suburban 2002 -
1992, Express, Savanna 1996,
Tahoe 2002 - 1995, Yukon 2000 - 1992,
Bravada 2001 - 1996, Jimmy 1998 - 1994, Silhouette,
Transport 1996 - 1990

UNIT PACKAGE: 1



23260

(12102763 PT392,
88862281, PT2362)

**Stop Lamp Switch &
Torque Coverter
Repair Harness Connector**

Three 12 Gauge
Three 16 Gauge
GXL 8" Leads
Switches: 12450076,
15705015, 15686968,
15732489
GM Truck 1994 - On

UNIT PACKAGE: 1

WARNING: Reproductive Harm & Cancer
www.P65Warnings.ca.gov

GM SOCKET ASSEMBLY & HARNESS CONNECTORS

MISCELLANEOUS

Photos not actual size



11440
(2962510)

**Air Conditioner Blower Relay
Harness Connector**
18 Gauge Wire
GM, AMC & Chrysler

UNIT PACKAGE: 10



18871
(12101939)

**Harness Connector for
Cooling Fan, Fuel Pump,
Starter Interrupt Relay &
Fan Control Switch**
Cadillac 1988-On

UNIT PACKAGE: 1

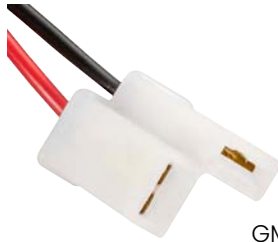

22771
(12126032; PT663)

**Signal Flasher & Relay
Repair Harness Connector**
Two 20 ga. 6" Leads
GM, Ford, Chrysler & Import Cars
& Trucks 2002 - 1956

UNIT PACKAGE: 1



23054

(15306045, PT1205,
88862290, PT2371)

**Fuel Pump, Head Lamp,
Blower, ABS, Horn Relay Repair
Harness Connector**

Three 14 Ga. & Two 12 Ga.
GXL 8" Leads
Relays: 12077864, 12077867,
12088577, 12135113, 12193601
GM Vehicles 1993 - On

UNIT PACKAGE: 1



23081

(12085501, 12102491, 15306002,
88862280, PT122, PT1115, PT282,
PT2361)

**Fuel Pump, Blower Motor &
Daytime Running Lamp Relay
Repair Harness Connector**

Two 14 Ga. & Three 12 Ga.
GXL 8" Leads
Relay: 14089936
GM 1987 - On

UNIT PACKAGE: 1



23092

(12101885, 12101939,
12126460, 88987189, 88862270,
PT156, PT211, PT730, PT1636,
PT2351)

**Relay Repair Harness
Connector Kit**

Contains:
1 Hard-Shell, 1 Lock
One 10 Gauge,
One 12 Gauge, Two 18 Gauge
GXL 4" Leads
GM 1982 - On

UNIT PACKAGE: 1

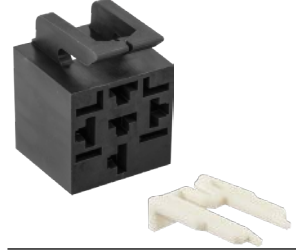

23184

**Cooling Fan Relay Repair
Harness Connector**

Four 18 Gauge
Two 12 Gauge
GPT 8" Leads
Relay: 10038311, 10032082
GM 1985 - On

UNIT PACKAGE: 1

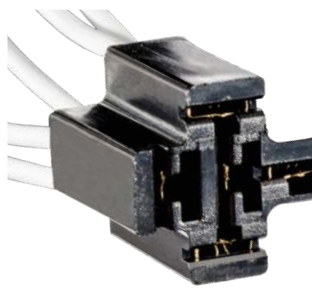

23196

(12102696, 88861106,
89057715, 88862254
PT363, PT1842, PT2163,
PT2335)

**Universal 5 Blade Relay
Repair Harness
Connector**

Gauge: 16
Five GXL 8" Leads
GM 1980 - On &
General Purpose

UNIT PACKAGE: 1



23210

(12101881, PT152,
12101882, PT153)

**Relay Repair Harness
Connector with Shroud**

Three 18 Ga. & Two 12 Ga.
GPT 8" Leads
GM 1988 - 1993

UNIT PACKAGE: 1



23259

(12101871, PT262,
88862286, PT2367)

**Glow Plug Control Repair
Harness Connector**

Gauge: 18
Four SXL 8" Leads
Controller: 12088520
GM Trucks 1985 - On

UNIT PACKAGE: 1

WARNING: ALL ITEMS ON PAGE Reproductive Risk & Cancer www.P65Warnings.ca.gov

GM SOCKET ASSEMBLY & HARNESS CONNECTORS

CHARGING & STARTING AND SENSORS

Sec. 12

Photos not actual size

CHARGING & STARTING

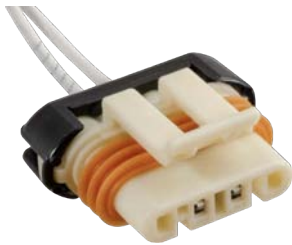

22934
(15306329; PT1383)

**Alternator Repair
Harness Connector**
Two 18 Ga. 18" Leads

Buick Rainier & Rendezvous 2007 - 2004
Cadillac Escalade 2006 - 2002
Chevrolet Avalanche, Blazer, Classic, Cobalt,
Colorado, Express 1500-4500, HHR, Malibu, S10, Silverado
1500-3500, SSR, Suburban, Tahoe & Trailblazer and
GMC Canyon, Envoy, Jimmy,
Savana 1500-4500, Sierra, 1500-3500,
Sonoma & Yukon 2011 - 2000
Hummer H2 2007 - 2003
Isuzu Ascender, I-280 & I-350 2006 - 2003
Oldsmobile Alero & Bravada 2004 - 2001
Pontiac G5, G6, Grand AM & Pursuit 2010 - 2002
Saab 9-7X 2006 - 2005; Saturn Aura & Ion 2008 - 2006

UNIT PACKAGE: 1

SENSORS



14580
(12102621)

**Radiator Fan Sensor Switch
Harness Connector**

Fits electric cooling fan switches:
3040674, 14043275 and 14043276
GM 1980-On

UNIT PACKAGE: 1

⚠️ WARNING: Reproductive Harm & Cancer
www.P65Warnings.ca.gov

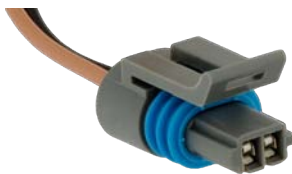

16693
(12046624, 12102620)

**Replacement Harness
Connector used with
1985-on GM Manifold**

Air Temperature Sensors including 25036751. Features
two 9" long 18 gauge wire leads.

UNIT PACKAGE: 1

⚠️ WARNING: Reproductive Harm & Cancer
www.P65Warnings.ca.gov



16964
(12085502)
Green

**Manifold Absolute Pressure
(MAP) Harness Connector**

Fits GM MAP Sensor 6137039 on
GM vehicles (38 models) 1982-on

UNIT PACKAGE: 1

⚠️ WARNING: Reproductive Harm & Cancer
www.P65Warnings.ca.gov



17107
(12117385)

**Oxygen Sensor
Connector Pigtail**

Fits the Following Oxygen Sensors:

8990469 (AC-Delco AFS13P)
8990625 (AC-Delco AFS15P)
8990741 (AC-Delco AFS16P)
10042186 (AC-Delco 213-15)
25105107 (AC-Delco AFS20)
25105901 (AC-Delco AFS21)
25106073 (AC-Delco AFS22)
Most GM Models 1982-On

UNIT PACKAGE: 1



17110
(12102747)

**Windshield Washer Pump,
Low Coolant Sensor
Harness Connector**
GM Cars & Trucks 1992-87

UNIT PACKAGE: 1



18524
(12085497)

**MAP Mass Air Flow Sensor
Harness Connector**

GM with 2.8 Eng &
Sequential Fuel Injection
1989-85

UNIT PACKAGE: 1



18527
(12102748)

**Throttle Position Sensor
Harness Connector**

GM 1994-90

UNIT PACKAGE: 1



18674
(12126451)

**Coolant Temperature
Sensor Harness Connector**

Fits Sensor 10232601 & 25037203
GM 1987-On

UNIT PACKAGE: 1

**GM SOCKET ASSEMBLY & HARNESS CONNECTORS
SENSORS**

Photos not actual size



18868
(12085495)

**Mass Air Flow Sensor
Harness Connector**
GM 1988-On

UNIT PACKAGE: 1



18870
(12101855)

**Direct Ignition
Vehicle Speed Sensor
Harness Connector**
GM
1987-On

UNIT PACKAGE: 1



18917
(12085538)

**Camshaft Sensor
Harness Connector**
Buick, Olds & Pontiac
1992-86

UNIT PACKAGE: 1



22770
(12125649; PT561)

**ABS Speed, Air Temp Sensors,
Power Mirror &
Door Lock Switch
Repair Harness Connector**
Two 18 ga. 8" Leads
GM Cars & Light Duty Trucks
2002 - 1990

UNIT PACKAGE: 1

WARNING: Reproductive Harm & Cancer
www.P65Warnings.ca.gov

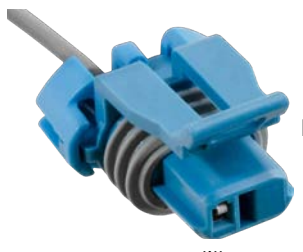

22932
(12126458; PT728)

**Engine Coolant Temp Sensor,
A/C Compressor &
Master Cylinder Reservoir
Repair Harness Connector**
One 18 Ga. 8" Lead

Cadillac Escalade 2000 - 1999
Chevrolet Astro, Blazer, C/K1500 - C/K3500,
Express, G10 - G30, Impala, P30, S10,
Suburban & Tahoe 2005 - 1991
GMC C/K1500 - C/K3500, G1500 - G3500,
Jimmy, Safari, Savana, Sonoma, Suburban,
Typhoon & Yukon 2005 - 1992
Oldsmobile Bravada 1997 -1996

UNIT PACKAGE: 1



22935
(19179280; PT2427)

**Cam/Crank Sensor,
Ignition Coil, MAP Sensor,
Oil Pressure Switch &
Throttle Position Sensor
Repair Harness Connector**
Three 22 Ga. 8" Leads

Cadillac DeVille, Eldorado, Fleetwood &
Seville 1988 - 1980, Chevrolet Express 1500-3500 &
Silverado 1500, GMC Savanna 1500-3500,
Silverado 1500 2014 - 2007, Pontiac Gran Prix 1984,
Acura CL, MDX, RDX, RL, RSX, TL & TSX 2012 - 2001,
Honda Accord, Civic, CR-V, Element, Fit,
Insight, Odyssey, Pilot & Ridgeline 2011 - 2003,
Scion FR-S, iA 2016 - 2013,
Toyota Yaris 2018 - 2017

UNIT PACKAGE: 1

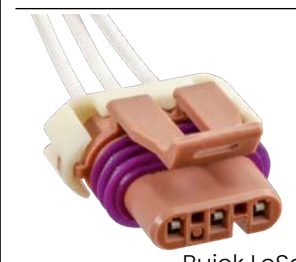

22936
(88987992; PT1795)

**Ignition Coil & Flex Fuel Sensor
Repair
Harness Connector**
Three 18 Ga. 8" Leads

Buick LeSabre, Park Avenue
& Roadmaster 2005 - 1996
Cadillac Deville, Eldorado,
Fleetwood & Seville 2005 - 1999
Chevrolet Astro, Avalanche, Blazer, C/K1500-C/K3500,
Camaro, Caprice, Corvette, Express 1500-3500, G30,
Impala, P30, S-10 Silverado 1500-3500, Sonoma,
Suburban, Tahoe 2007 - 1995
GMC C/K1500-C/K3500, G3500, Jimmy, P3500,
Safari Savana, Sierra 1500-3500,
Sonora & Yukon 2007 - 1996
Oldsmobile Auror & Bravada 2003 - 1996
Pontiac Bonneville, Firebird & Sunbird 2005 - 1994
Isuzu Hombre & NPR 2006 - 2002

UNIT PACKAGE: 1



23003

**Throttle Position Harness
Connector**
Length: 8"
Gauge: 16
6 Wires

WARNING: Reproductive Harm & Cancer
www.P65Warnings.ca.gov

UNIT PACKAGE: 1

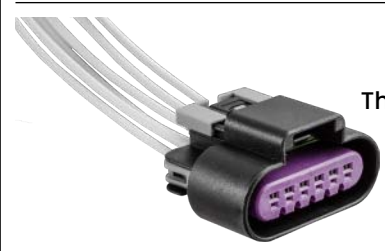

23004

**Throttle Position Harness
Connector**
Length: 8"
Gauge: 16
6 Wires

WARNING: Reproductive Harm & Cancer
www.P65Warnings.ca.gov

UNIT PACKAGE: 1

SENSORS

Photos not actual size

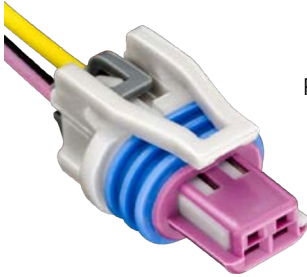

23016

(12046623, 12101899, 12126469, 15306031, 88987993, PT169, PT739, PT1158, PT1798, WPT-751, 3U2Z-14S411-EMMA)

Coolant Temp & Speed Sensor Repair Harness Connector

Gauge: 18
Two 12" Leads
Sensors: 25036708, 25036979
Crank Sensors: 1103703, 1103661, 10456043
GM 1985 - On
Ford

UNIT PACKAGE: 1



23034

(12102748, PT375, 12126473, PT743, 88862238, PT2319, 5C3Z-12224-A)

Throttle Position, Fuel Injection Timing & EGR Pressure Feedback Sensor Repair Harness Connector

Gauge: 20
Three TXL 8" Leads
Throttle Sensor: 17112679, 17106681, 17123852
Fuel Sensor: 3C3Z-9F838-AA, 3C3Z-9F838-EA & 4C3Z-9J460-A
GM 1990 - On
Ford 'F' Super Duty & Excursion 6.0 1999 - 2007

UNIT PACKAGE: 1



23020

(12126487, PT757, 19115673, PT2203, 19257375, PT2605, 88862215, PT2296, 3U2Z-14S411-SCA, WPT-704, 8U2Z-14S411-DA, WPT-915)

Distributor Module Repair Harness Connector

Gauge: 18
Four TXL 8" Leads
Module: 1987466, GM 1985 - 1992
Ignition Coil: 12558693, Lt. Duty GM Trucks 1999 - 2007
Crank Sensor: 25526124, 25535481, 25526122
GM w/2.8 Eng. 1985 - On, w/3.8 1988 - On
IAC Valves, GM 1987 - 2007 & Chrysler 1986 - 1995
Door jamb switch, Ford 2003 - 2007

UNIT PACKAGE: 1



23046

(12117025, PT420, 88862272, PT2353, 3U2Z-14S411-UNA, WPT-763)

Crank Position Sensor, Electric Brake Module, Engine Cooling Fan Motor, Engine Coolant Level Switch & Lamp Socket Repair Harness Connector

Gauge: 16
Three GXL 8" Leads
Sensor: 10154687
GM Car & Truck 1990 - On
Ford

UNIT PACKAGE: 1



23026

(12085492, PT114, 12085497, PT119, 88862224, PT3205)

Mass Air Flow Sensor Repair Harness Connector

Gauge: 20
Three TXL 8" Leads
Sensors: 25007554, 25007555, 25007770, 25007877, 25043940, 25043941

UNIT PACKAGE: 1



23053

(15305942, PT1174, 88987184, PT1627, 88862287, PT2368)

Crank Sensor & Ignition Coils Repair Harness Connector

Gauge: 18
Four TXL 8" Leads
Sensors: 12537111, 24500988, 24501417, 25533327
Coils: 10457730, 12558693, 12570616, 12573190, 19005218
GM 1988 - On

UNIT PACKAGE: 1

GM SOCKET ASSEMBLY & HARNESS CONNECTORS

SENSORS

Photos not actual size



23124

(12085537, PT147, 15306009, PT1136, 15324824, 88862284, PT2365)

Neutral/Park & Rear Wiper Switch, Alternator, Wheel/Vehicle Speed Sensors, Repair Harness Connector

Gauge: 18
Four GXL 8" Leads
Switch: 19943363, 1994335
GM 1986 - On

UNIT PACKAGE: 1



23160

Ignition, Cam, Crank, Map, TPS Sensor Harness Connector

Length: 8"
Gauge: 14
3 Wires

UNIT PACKAGE: 5



23145

(12116257, PT430, 88862222, PT2303)

Throttle Position Sensor Repair Harness with Seal

Gauge: 18
Three 10" Leads
GM 1983 - On with Fuel Injection

UNIT PACKAGE: 1



23181

(12085485, PT107, 88862267, PT2348, 3U2Z-14S411-NZA, 3U2Z-14S411-SFA, WPT-494, WPT-564, 5019910AA)

Backup Lamp Switch, Speed Sensor, IAC Value Repair Harness Connector

Gauge: 12
Two SXL 8" Leads
Switch: 23049569, D2220A
GM Cars & Trucks 1971 - On, Ford Mustang 2001-2014

UNIT PACKAGE: 1



23147

(12085524, PT134, 88862250, PT2331)

2 Cavity Shroud Weather Pack

Gauge: 16
Two 8" GXL Leads
Mates with 23263
GM Vehicles 1990 - On

UNIT PACKAGE: 1



23190

(12167120, PT786, 88862292, PT2373)

In-Line Brakes, Engine, Lamps, Wheel Speed Sensor Repair Harness Connector

Gauge: 18
Two GXL 8" Leads
4 Wheel Drive & Power Steering
GM Cars & Trucks 1992 - On

UNIT PACKAGE: 1

(12102747, PT374, 88862226, PT2307, 13580106, PT2625, 3U2Z-14S411-CJAA, WPT-692)

23156

A/C Pressure Cycling & Backup Lamp Switch, Wheel Speed Sensor, EGR Valve Control & Windshield Waser Pump, Fog Lamp Repair Harness Connector

Gauge: 16
Two GXL 8" Leads
Switch: 25604949
Pump: 22127653
GM Car & Truck 1987 - On, Ford 2000 - On, SAAB

UNIT PACKAGE: 1

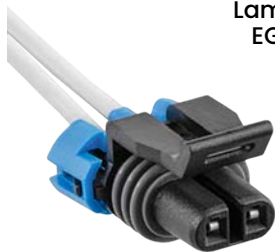

23226

(15305960, PT1069)

O2 Sensor Repair Harness Connector

Gauge: 16
Four GXL Grey 8" Leads
GM Cars & Lt Duty Trucks 1998 - 2011

UNIT PACKAGE: 1

WARNING: ALL ITEMS ON PAGE Reproductive Risk & Cancer www.P65Warnings.ca.gov

SENSORS

Photos not actual size

SENSORS

23241



Crank, Park Aid Harness Connector
Length: 8"
Gauge: 18
3 Wires

UNIT PACKAGE: 1

23243



Crank Sensor, Oil Pressure Harness Connector
Length: 8"
Gauge: 16
3 Wires

UNIT PACKAGE: 1

23268

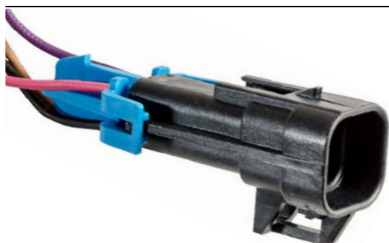

(15305801, PT919, 88862293, PT2374)

Oxygen Sensor Repair Harness Connector
Gauge: 18

Four TXL 8" Leads

Sensors: 25162980, 25312195, 25161130, 25161131, 25162981, 25164727, 25164983, 25167114, 25170120
GM 1995 - On

UNIT PACKAGE: 1

WARNING: Reproductive Harm & Cancer
www.P65Warnings.ca.gov

SWITCHES

25210

(88986460; PT2048)



Canister Vent Solenoid, Ignition Coil, EGR Solenoid, High Mount Stop Light, Crank Position Sensor & Variable Valve Timing Solenoid Repair Harness Connector

2-16 Ga.

8" Wire Leads

GM Camaro, Malibu 2013 - 2005; Equinox 2010 - 2005, Nova 1988 - 1986, Metro 2001 - 1998, Tracker 2004 - 2001, Acadia 2010 - 2007, Yukon 2009 - 2008, Solstice, Torrent 2009 - 2006, Vibe 2005 - 2003; Saturn Outlook, Relay 2007, Sky 2009 - 2007; Hyundai Accent 2013 - 2005, Elantra 2010 - 2002, Equus 2016 - 2011, Genesis 2016 - 2009, Santa Fe, Tuscon 2015 - 2010, Sonata 2014 - 2005, Tiburon 2013 - 2003, Veloster 2013 - 2012; Kia Borrego 2011 - 2009, Forte 2015 - 2010, K900 2017 - 2015, Magentis 2009 - 2008, Optima 2015 - 2006, Rio 2014 - 2005, Rondo 2014 - 2007, Sorento 2015 - 2011, Soul 2013 - 2010, Spectra 2009 - 2004, Sportage 2016 - 2004; Lexus ES300 2003 - 1999, ES330 2006 - 2004, ES350, GS450h, LS460, RX350 2013 - 2007, GS400 2000 - 1998, GS430 2007 - 2001, GS460 2011 - 2008, GX460, RX450h 2013 - 2010, GX470 2007 - 2003, HS250h 2012 - 2010, IS F 2014 - 2008, IS250, 2013 - 2006, IS300 2005 - 2001, LS400 2000 - 1999, LS430 2006 - 2001, LS600h, LX570 2013 - 2008, LX470 2007 - 1998, RX300 2003 - 1999, RX330 2006 - 2004, RX400h 2008 - 2006, SC300, SC400 2000 - 1992, SC430 2010 - 2002; Scion IQ 2015 - 2012, tC 2010 - 2005, xA 2006 - 2004, xB 2015 - 2004; Subaru Impreza 2005 - 1998, Legacy 2004 - 1998, Suzuki Sidekick 1998 - 1996, Swift 2001 - 1998, XL-7 2009 - 2006; Toyota 4Runner 2010 - 1988, Avalon 2016 - 2000, Camry 2011 - 2002, Corolla 1989 - 1986; Paseo 1994 - 1992, Pickup 1995 - 1988, Solara 2008 - 2004, T100 1998 - 1993, Tacoma 2016 - 1995, Tundra 2016 - 2005, Venza 2013 - 2009, Yaris 2014- 2006

UNIT PACKAGE: 1

11436



Dimmer Switch Harness Connector
GM

UNIT PACKAGE: 10

WARNING: Reproductive Harm & Cancer
www.P65Warnings.ca.gov

GM SOCKET ASSEMBLY & HARNESS CONNECTORS

SWITCHES

Photos not actual size

11438



Temperature Sending Unit
Harness Connector
GM
Voltage Regulator
Harness Connector
Chrysler

UNIT PACKAGE: 10

13644



Right Angle Pigtail
General Purpose
11-1/2" Wire Lead for .160 Stud
Ford

UNIT PACKAGE: 10

17690

(12101903)



Washer Fluid Sensor
Harness Connector
Also used on Back-Up
Light Switch & A.C. Compressor Switch
GM 1985-On

UNIT PACKAGE: 5

18530

(Not Supplied by O.E.M.)

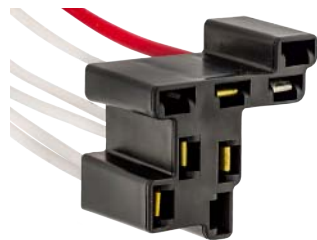

Headlight Switch
Harness Connector
Fits Switch 1995217
GM 1991-68

UNIT PACKAGE: 1

18916

(12085483)



Ignition Module, Crankshaft
Coolant Sensor & Power
Steering Pressure Switch
Harness Connector
GM 1986-On

UNIT PACKAGE: 1

19554

(12102757)



Harness Connector
Headlight & Ignition
Switch

UNIT PACKAGE: 1

19555

(12102757)



Harness Connector
Headlight Dimmer Switch
GM Most Models
1990-On

UNIT PACKAGE: 1

19882

(12085485)



Back-Up Light Switch &
Speed Sensor Harness Connector
Used with Switch 23049569,
PT107 & IACV Motor
GM 1971-On

UNIT PACKAGE: 1

21490

(12102664, 88862264;
1U2Z-14S411-YA)



Fog & Front Lights,
Power Steering & Oil Pressure
Switch Harness Connector
GM 2005 - 1986
Ford 2004 - 1995
Jeep Eagle 1994

UNIT PACKAGE: 1

22770

(12125649; PT561)



ABS Speed, Air Temp Sensors,
Power Mirror &
Door Lock Switch
Repair Harness Connector
Two 18 ga. 8" Leads
GM Cars & Light Duty Trucks
2002 - 1990

UNIT PACKAGE: 1

WARNING: Reproductive Harm & Cancer
www.P65Warnings.ca.gov

WARNING: ALL ITEMS ON PAGE Reproductive Risk & Cancer www.P65Warnings.ca.gov

SWITCHES

Photos not actual size



22772

(12126453; PT724)

**Dome Lamp, Headlight Actuator,
4WD Lamp & Selector Switch
Repair Harness Connector**

Two 18 ga. 12" Leads
GM Light Duty Trucks
2000 - 1988

UNIT PACKAGE: 1

⚠️ WARNING: Reproductive Harm & Cancer
www.P65Warnings.ca.gov



22773

(15305874; PT1015)

**Headlight Actuator &
Switch, Cooling Fan Motor,
Taillight Circuit Board &
Windshield Wiper Motor
Repair Harness Connector**

Five 18 ga. 17" Leads
GM Cars & Light Duty Trucks
2012 - 1991

UNIT PACKAGE: 1

⚠️ WARNING: Reproductive Harm & Cancer
www.P65Warnings.ca.gov



22776

(88953267; PT1616)

**Alternator, Door Jamb &
Brake Pressure Switch,
Washer Pump & Door Lock
Actuator Repair
Harness Connector**

Two 16 Ga. 5" Leads

Chevrolet Equinox 2007 - 2005
Hummer H2 2009 - 2003
Chrysler Cars & Light Duty Trucks 2018 - 1997
Jeep 2007 - 1998

UNIT PACKAGE: 1

⚠️ WARNING: Reproductive Harm & Cancer
www.P65Warnings.ca.gov



22935

(19179280; PT2427)

**Cam/Crank Sensor,
Ignition Coil, MAP Sensor,
Oil Pressure Switch &
Throttle Position Sensor
Repair Harness Connector**

Three 22 Ga. 8" Leads

Cadillac DeVille, Eldorado, Fleetwood &
Seville 1988 - 1980, Chevrolet Express 1500-3500 &
Silverado 1500, GMC Savanna 1500-3500,
Silverado 1500 2014 - 2007, Pontiac Gran Prix 1984,
Acura CL, MDX, RDX, RL, RSX, TL & TSX 2012 - 2001,
Honda Accord, Civic, CR-V, Element, Fit,
Insight, Odyssey, Pilot & Ridgeline 2011 - 2003,
Scion FR-S, iA 2016 - 2013,
Toyota Yaris 2018 - 2017

UNIT PACKAGE: 1



23006

**Stop Lamp Switch &
Harness Connector**

Length: 8"
Gauge: 12
4 Wires

UNIT PACKAGE: 1

⚠️ WARNING: Reproductive Harm & Cancer
www.P65Warnings.ca.gov

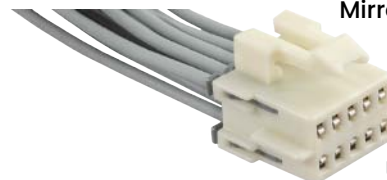

23008

**Ignition, Hazard, & Power
Mirror Switch & Harness
Connector**

Length: 8"
Gauge: 18
10 Wires

UNIT PACKAGE: 1

⚠️ WARNING: Reproductive Harm & Cancer
www.P65Warnings.ca.gov

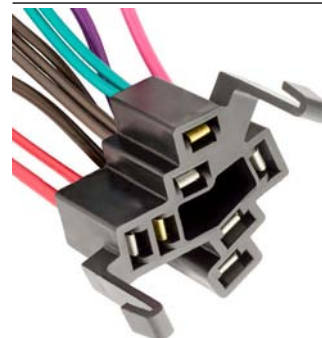

23009

(12125643, 88860519,
PT555, PT1964)

**Ignition Repair
Harness Connector**

Gauge: 14 & 18
Ten 6" Leads
GM "C", "G" & "P"
Trucks 1967 - 1993

UNIT PACKAGE: 6

⚠️ WARNING: Reproductive Harm & Cancer
www.P65Warnings.ca.gov

GM SOCKET ASSEMBLY & HARNESS CONNECTORS

SWITCHES

Photos not actual size



23046

(12117025, PT420,
88862272, PT2353
3U2Z-14S411-UNA, WPT-763)

**Crank Position Sensor, Electric
Brake Module,
Engine Cooling Fan Motor,
Engine Coolant Level Switch &
Lamp Socket Repair Harness
Connector**

Gauge: 16
Three GXL 8" Leads
Sensor:10154687
GM Car & Truck 1990 - On
Ford

UNIT PACKAGE: 1

⚠ WARNING: Reproductive Harm & Cancer
www.P65Warnings.ca.gov

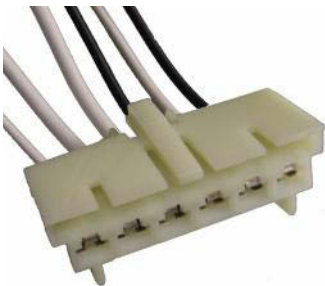

23065

(12101927, PT199,
88862273, PT2354)

**Headlight & Ignition
Switch Repair Harness
Connector**

Two 18 Ga., Two 16 Ga. &
Two 12 Ga.
Six GXL 8" Leads

Switch: 10470881, 10471139, 15693547, 1995287, 1995316,
1995330, 15702304, 15719854, 22534233
GM Cars & Trucks 1982 - 2002

UNIT PACKAGE: 1

⚠ WARNING: Reproductive Harm & Cancer
www.P65Warnings.ca.gov

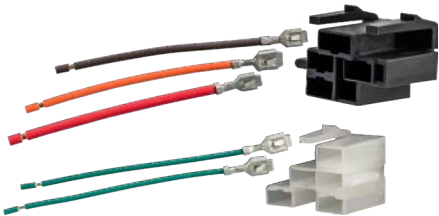

23090

(88860483,
PT1928)

Ignition Switch Harness Connector Kit

Contains: 2 Connectors (1-5 Position & 1-4 Position)
One 10 Ga., Two 12 Ga., Two 20 Ga.

GXL 4" Leads
Switches: GM 1990105, 1990109,
1990110, 1990115, 1990116, 7909811,
AMC/Jeep 3250575, 3250576, 8128889, 8128890
GM 1969 - On & AMC/Jeep 1978 - 1988

UNIT PACKAGE: 1

⚠ WARNING: Reproductive Harm & Cancer
www.P65Warnings.ca.gov



23124

(12085537, PT147, 15306009,
PT1136, 15324824, 88862284,
PT2365)

**Neutral/Park & Rear Wiper
Switch, Alternator, Wheel/
Vehicle Speed Sensors,
Repair Harness Connector**

Gauge: 18
Four GXL 8" Leads
Switch: 1994363, 1994335
GM 1986 - On

UNIT PACKAGE: 1



23138

**Dimmer Switch
Repair Harness
Connector**

Gauge: 18
Three 8" Leads
GM 1961 - 1979
Ford 1961 - 1979
IHC 1967 - 1983
Jeep 1963 - 1985

UNIT PACKAGE: 10

⚠ WARNING: Reproductive Harm & Cancer
www.P65Warnings.ca.gov

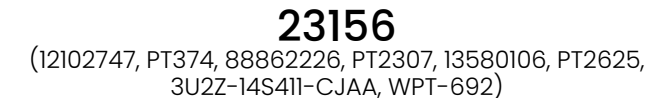

23156

(12102747, PT374, 88862226, PT2307, 13580106, PT2625,
3U2Z-14S411-CJAA, WPT-692)

**A/C Pressure Cycling & Backup
Lamp Switch, Wheel Speed Sensor,
EGR Valve Control & Windshield
Washer Pump, Fog Lamp
Repair Harness Connector**

Gauge: 16
Two GXL 8" Leads
Switch: 25604949
Pump: 22127653
GM Car & Truck 1987 - On,
Ford 2000 - On, SAAB

UNIT PACKAGE: 1

⚠ WARNING: Reproductive Harm & Cancer
www.P65Warnings.ca.gov

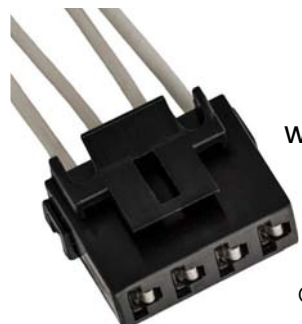

23157

(12085487, PT109,
88862268, PT2349)

**Wiper Motor, Windshield Wiper
& Window Switch
Repair Harness Connector**

Gauge: 18
Four GXL 8" Leads
Wiper Motor 22062912
GM Cars & Trucks 1984 - 1995

UNIT PACKAGE: 1

⚠ WARNING: Reproductive Harm & Cancer
www.P65Warnings.ca.gov

SWITCHES

Photos not actual size



23163

Oil Pressure Switch & Harness Connector
Length: 8"
Gauge: 18
3 Wires

UNIT PACKAGE: 1



23181

(12085485, PT107, 88862267, PT2348, 3U2Z-14S411-NZA, 3U2Z-14S411-SFA, WPT-494, WPT-564, 5019910AA)

Backup Lamp Switch, Speed Sensor, IAC Value Repair Harness Connector
Gauge: 12

Two SXL 8" Leads
Switch: 23049569, D2220A
GM Cars & Trucks 1971 - On,
Ford Mustang 2001-2014

UNIT PACKAGE: 1



23243

Crank Sensor Oil Pressure Harness Connector
Length: 8"
Gauge: 16
3 Wires

UNIT PACKAGE: 1



23252

(12085539, PT149, 88862244, PT2325, 3U2Z-14S411-VFA, WPT-685)

Oil & Low Air Pressure Switch Repair Harness Connector
Gauge: 14

Four SXL 8" Leads
Switches: 3532954, 10206847, 12555492, 25605389, 25627057
GM "E", "H" & "W" Bodies 1987 - 1994
Ford

UNIT PACKAGE: 1



23254

(12085500, 15306358, PT100, 88862245, PT2326, 88988620, PT2105)

Oil Pressure Switch Repair Harness Connector
Gauge: 18

One GXL 8" Lead
Switch: 10240133, 10240134
GM "L", "Y", & "F" Bodies 1987 - 1994

UNIT PACKAGE: 1

WARNING: Reproductive Harm & Cancer
www.P65Warnings.ca.gov



23260

(12102763 PT392, 88862281, PT2362)

Stop Lamp Switch & Torque Converter Repair Harness Connector
Three 12 Gauge
Three 16 Gauge
GXL 8" Leads

Switches: 12450076, 15705015, 15686968, 15732489
GM Truck 1994 - On

UNIT PACKAGE: 1

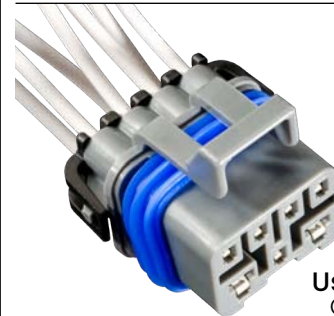

23261

(15305887, PT1031, 88862288, PT2369)

Neutral Safety Switch Harness Connector
Gauge: 18

Seven GXL 8" Leads
Switch: 12450016
Use with 23262 (99-8043)
GM Car & Trucks 1995 - On

UNIT PACKAGE: 1



23262

(15305925, 88860579, PT1184, PT2024)

Neutral Safety Switch Harness Connector
Gauge: 16

Four GXL 8" Leads
Switch: 12450016
Use with 23261 (99-8042)
GM Car & Trucks 1995 - On

UNIT PACKAGE: 1

WARNING: ALL ITEMS ON PAGE Reproductive Risk & Cancer www.P65Warnings.ca.gov

FORD SOCKET ASSEMBLY & HARNESS CONNECTORS

LIGHTING

Photos not actual size



8761

License Plate & Instrument Panel Lights For 5/8" Hole Bulb No. 51, 53, 55, 57 & 57X Ford

UNIT PACKAGE: 10



8763 (13235-A)

Weatherproof Covered Neoprene Signal, Park, Stop & Tail Lights Bulb No. 198, 1016, 1034, 1154 & 1157

UNIT PACKAGE: 10

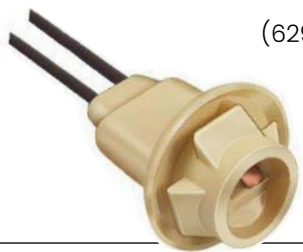

9883

(6298886, 6298892, 6298935; D0DZ-15A434B)

Side Marker Assembly Bulb No. 158, 194, 194A GM & Ford

UNIT PACKAGE: 5

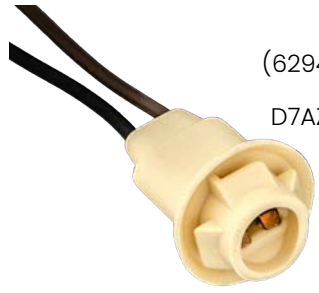

11166

(6294015, 8901283, 8918527; D40Z-13410E, D7AZ-13412A, D7FZ-13412A)

Side Marker and License Plate Lights Bulb No. 158, 194, 194A GM & Ford

UNIT PACKAGE: 1



11439

Headlight & Flasher For all cars using 3 prong sealed Headlight Bulbs 4002, 3, 5, 5040, 2, 5400, 2, 40, 421, 6006, 12 & 13 Also fits 2 & 3 Prong Flashers

UNIT PACKAGE: 10

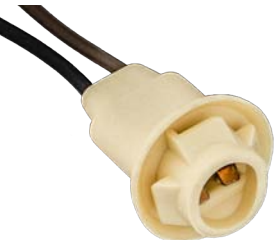

11441

Instrument Panel and Marker Lights Bulb No. 158, 194, 194A GM & Ford

UNIT PACKAGE: 10



12237

(3744750; 1200431I, 25015169; C80Z-13711A)

Instrument Panel Socket for 1/2" Hole Bulb No. 194 GM, Ford & Chrysler

UNIT PACKAGE: 2

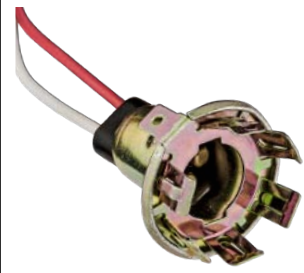

13537

(DIAZ-13410B)

Stop & Tail Lights with one Ground Male Blade Terminal Bulb No. 1034, 1154 & 1157 Ford

UNIT PACKAGE: 1



13559

Headlight & Flasher For all cars using 2 prong Sealed Headlight Bulb No. 4001

UNIT PACKAGE: 3



14130

(D4ZZ-13234-A)

Signal & Parking Lights Bulb No. 1157 Ford

UNIT PACKAGE: 1

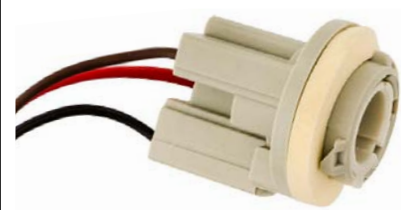

14133

(D4LY-13410-A)

Tail & Stop Lights Bulb No. 1157 Ford

UNIT PACKAGE: 1

LIGHTING

Photos not actual size



14135
(DIFZ-13234-A)

Parking Lights
Bulb No. 1157
Ford

UNIT PACKAGE: 1

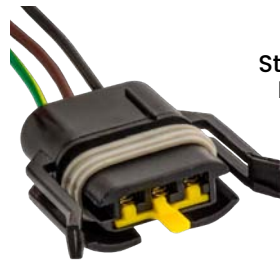

19125
(Not Supplied by O.E.M.)

Stop, Tail, Turn & Parking Lights
Plugs into Light Socket Base
For Double Filament
Wedge Type Bulbs
Ford Ranger, Explorer &
Econoline 1991-On

UNIT PACKAGE: 1



14918
(12048369)

Headlight Socket Assembly
For High-Low 9004 &
9007 Halogen Bulb
GM, Ford & Imports

UNIT PACKAGE: 1

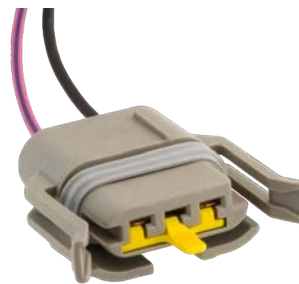

19126
(Not Supplied by O.E.M.)

Back-Up Lights Plugs into
Light Socket Base
For Single Filament
Wedge Type Bulbs
Ford Ranger, Explorer &
Econoline 1991-On

UNIT PACKAGE: 1

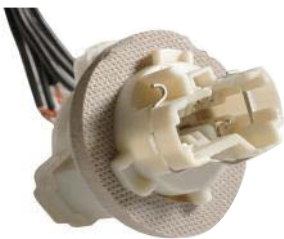

16174

Headlight Socket Assembly
For Low Beam 9006
Halogen Bulb
Single Indexing Groove
GM, Ford, AMC & Imports

UNIT PACKAGE: 4



20837
(Not Supplied by O.E.M.)

Stop & Tail Light
Three 20 Gauge
Wire Leads
Uses 2458, 3057 &
3157 Wedge Type Bulbs
Ford 1987 - On

UNIT PACKAGE: 1



16175
(12101898)

Headlight Socket Assembly
For High Beam 9005
Halogen Bulb
Two Indexing Grooves
GM, Ford, AMC & Imports

UNIT PACKAGE: 4



20848
(Not Supplied by O.E.M.)

Rear Light Assembly
Harness Connector
Four 18 Gauge Wire Leads
Ford F250 thru F750 without Pick Up Box 1999 - On

UNIT PACKAGE: 1

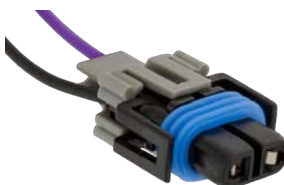

16694
(12043215, 12085498)

Cornering & Fog Light Socket
for 881 & H11 Halogen Bulbs
GM

UNIT PACKAGE: 1



21210
(Not Available from O.E.M.)

Universal Headlight Harness Connector
Two 18 Gauge 6" Long Leads
For H7 Halogen Bulbs
Ford, Audi, BMW, Hyundai,
Kia, Mazda, Mercedes,
Mini Cooper, Saab & Subaru

UNIT PACKAGE: 1

WARNING: ALL ITEMS ON PAGE Reproductive Risk & Cancer www.P65Warnings.ca.gov

FORD SOCKET ASSEMBLY & HARNESS CONNECTORS

SWITCHES

Photos not actual size



21490

(12102664, 88862264
1U2Z-14S411-YA)

Fog & Front Lights, Power Steering & Oil Pressure Switch Harness Connector
GM 2005 - 1986
Ford 2004 - 1995
Jeep Eagle 1994

UNIT PACKAGE: 1



22425

(3U2Z-14S411-FKAA,
3U2Z-14S411-FKAB,
5U2Z-14S411-XA, WPT-793,
WPT-859, WPT943)

Headlight Harness Connector
Three 16 ga. TXL 8" Wire Leads
For 9008/H13 Halogen Bulb
Replaces Auveco 20847
Ford 2004 - On

UNIT PACKAGE: 1



22796

(2U5Z-13411-DA)

Park, Stop, Tail & Turn Signal Lights Socket Base
For Bulb No. 3157
Black Housing
90° Angle Base
Use with Auveco No. 23061
Ford Cars & Trucks 1995 - On

UNIT PACKAGE: 1



23028

(3U2Z-14S411-JDA,
WPT-286, 88860469, LSI52)

Cornering & Side Marker Lamps Socket Assembly
Gauge: 18
Two GPT 8" Leads
For 3156 Wedge-Style Bulbs
Ford 1987 - On

UNIT PACKAGE: 1



23029

(Not Available from OEM)

Rear Lamp Socket Assembly
Gauge: 18
Two GPT 8" Leads
For 3156 Wedge-Style Bulbs
Ford 1987 - On

UNIT PACKAGE: 1



23046

(12117025, PT420,
88862272, PT2353
3U2Z-14S411-UNA, WPT-763)

Crank Position Sensor, Electric Brake Module, Engine Cooling Fan Motor, Engine Coolant Level Switch & Lamp Socket Repair Harness Connector

Gauge: 16
Three GXL 8" Leads
Sensor: 10154687
GM Car & Truck 1990 - On
Ford

UNIT PACKAGE: 1



23055

(3U2Z-14S411-EKA,
4U2Z-14S411-RA,
WPT-254, WPT-837)

Rear AXL Speed Sensor, Backup & Stop Lamp Socket Repair Harness Connector

Gauge: 20
Two TXL 8" Leads
Sensors: 1L2Z-9E731-AA,
1L2Z-9E731-AA,
DY887, DY1000
Socket: 6E5Z-13411-AA
Ford Explorer/Mountaineer & Aviator 2002 - On
Ford Fusion, Zephyr,
MKZ, Milan 2006 - On

UNIT PACKAGE: 1

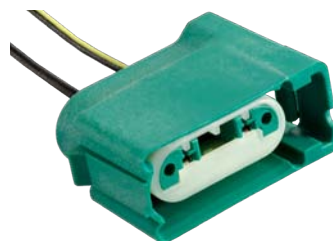

23058

(3U2Z-14S411-DNAA,
6U2Z-14S411-CA,
WPT-773, WPT-868)

Straight Lamp Socket Assembly

Gauge: 18
Two TXL 8" Leads
For Wedge Bulb
Ford Escape, F150,
Taurus & Sable 2000 - On

UNIT PACKAGE: 1

WARNING: ALL ITEMS ON PAGE Reproductive Risk & Cancer www.P65Warnings.ca.gov

SWITCHES

Photos not actual size



23059

(3U2Z-14S411-FHAB,
WPT-1167, 88988117, PT1774)

**Straight Lamp
Socket Assembly**

Gauge: 18
Three TXL 8" Leads
For Wedge Bulb
Ford Focus, Escape, Ranger,
Explorer, Mountaineer,
F150 & F-Super Duty 1998 - On

UNIT PACKAGE: 1



23061

(3U2Z-14S411-CKAA,
WPT- 671, 6U2Z-14S411-AA, AB,
WPT-866, WPT-1025
88988139, PT1783)

**90° Lamp
Socket Assembly**

Gauge: 18
Three TXL 8" Leads
For Wedge Bulb
Ford Focus, Escape, Expedition, Navigator, Explorer,
Mountaineer, Ranger, Freestar, Monterey,
F150, F Super Duty & Excursion 1995 - On

UNIT PACKAGE: 1



23064

(3U2Z-14S411-JLA,
WPT292, WPT830,
5C3Z-14S411-AA)

**Vehicle Speed Sensor,
Relays, Switches, Lamps,
Pumps & Motors
Repair Harness Connector**

Gauge: 16
Two TXL 8" Leads
Sensors: 6L3Z-9E731-A,
DY-1073
Ford, Lincoln & Mercury Cars &
Lt Duty Trucks 2000- On

UNIT PACKAGE: 1



23100

(F81Z-13411-AA,
AL8Z-13411-B)

**License, Side Marker &
Backup, Straight Housing
Socket Assembly**

For T-3-1/4 Wedge Base Bulb
Use with 23128 (99-8429)
Ford, Lincoln, Mercury Cars
& Lt. Duty Trucks 1999 - On

UNIT PACKAGE: 1



23101

(2U5Z-13411-RA)

Backup Lamp Socket

For 3156 Bulb
Use with 23058
Ford Cars &
Trucks 2000 - On

UNIT PACKAGE: 1



23102

(2U5Z-13411-SA)

**Park & Turn Signal, Tail &
Side Marker Lamp Socket**

For 3157 Bulb
Use with 23059 (99-8533)
Ford Cars & Trucks 1998 - On

UNIT PACKAGE: 1

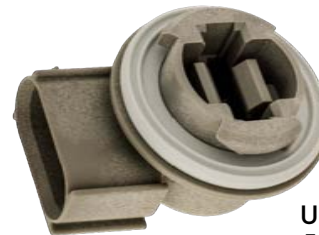

23103

(2U5Z-13411-AA)

**Backup, Stop/Turn/Tail
Lamp Socket**

90° Housing
For 3156 Bulb
Use with 23060 (99-8534)
Ford Cars & Trucks 2000 - On

UNIT PACKAGE: 1



23104

(2U5Z-13411-CA)

**Backup & Stop/Turn/Tail
Lamp Socket**

90° Housing
For 3156 Bulb
Use with 23060 (99-8534)
Ford Cars & Trucks 1998 - On

UNIT PACKAGE: 1

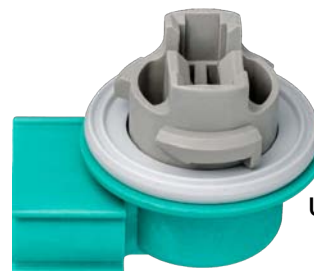

23105

(2U5Z-13411-HA)

Signal Lamp Socket

90° Housing
For 3156 Bulb
Use with 23058 (99-8532)
Ford Escape 2003 - On

UNIT PACKAGE: 1

WARNING: ALL ITEMS ON PAGE Reproductive Risk & Cancer www.P65Warnings.ca.gov

FORD SOCKET ASSEMBLY & HARNESS CONNECTORS

LIGHTING

Photos not actual size



23106
(2U5Z-13411-BB)
Backup, Park/Turn, Stop/Tail Lamp Socket
90° Housing
For 3157 Bulb
Use with 23061 (99-8535)
Ford Cars & Trucks 1999 - On

UNIT PACKAGE: 1



23129
(F81Z-13411-BA)
Park, Side Marker & Backup, Right Angle Housing Socket Assembly
For T-3-1/4 Wedge Base Bulb
Use with 23128
Ford Explorer, Excursion, Focus, Ranger & T. Bird, Lincoln Aviator, LS 1998 - On

UNIT PACKAGE: 1



23120
(88860530, PT1975)
Sealed Beam Socket Assembly
Gauge: 16
Three GXL 8" Lead
For Lamps H4666 and H6545
GM, Firebird, Blazer 1993 - On
Ford, Probe 1993 - On
Chrysler, Daytona, Laser 1989 - 1991

UNIT PACKAGE: 1

23156
(12102747, PT374, 88862226, PT2307, 13580106, PT2625, 3U2Z-14S411-CJAA, WPT-692)

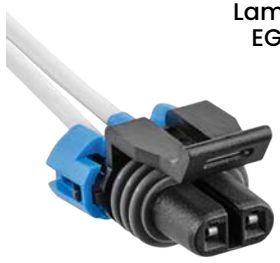

A/C Pressure Cycling & Backup Lamp Switch, Wheel Speed Sensor, EGR Valve Control & Windshield Waser Pump, Fog Lamp Repair Harness Connector
Gauge: 16
Two GXL 8" Leads
Switch: 25604949
Pump: 22127653
GM Car & Truck 1987 - On
Ford 2000 - On
SAAB

UNIT PACKAGE: 1



23121
(1U2Z-14S411-EA, WPT-106)
Straight Lamp Socket Assembly
Gauge: 18
Two TXL 8" Leads
For Wedge Bulb
Ford Windstar 1995 - On

UNIT PACKAGE: 1



23195
(F85Z-13411-AA, 88861087, LS219)
Running Board Light Socket Assembly
For T-3-1/4 Wedge Base Bulb
Use with 23194 (99-8143)
Ford Lt. Duty Trucks 1997 - On

UNIT PACKAGE: 1

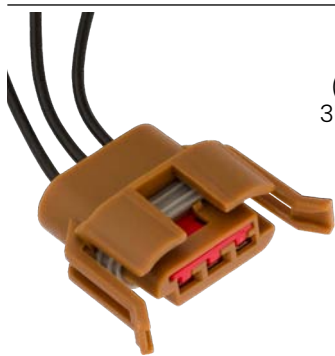

23122
(1U2Z-14S411-HA, WPT-109, 3U2Z-14S411-ECA, WPT-243)
Straight Lamp Socket Assembly
Gauge: 18
Three TXL 8" Leads
For Wedge Bulb
Ford Windstar

UNIT PACKAGE: 1



23200
(1U2Z-14S411-BDA, WPT-149, 1U2Z-14S411-BDB, WPT-964)
License Plate & Side Marker Light Socket Assembly
Gauge: 18
Two GXL 8" Leads
For T-3-1/4 Wedge Base Bulb
Ford Cars & Trucks 1998 - On

UNIT PACKAGE: 1



23128
(1U2Z-14S411-BEA, BEB, BEC, WPT-150, WPT-1204, WPT-1460)
Marker, Signal, License, Backup & Liftgate Lamp Socket Assembly
Gauge: 18
Two GXL 8" Leads
Use with 23100 & 23129
Ford Cars & Trucks 1998 - On

UNIT PACKAGE: 1

⚠️ WARNING: ALL ITEMS ON PAGE Reproductive Risk & Cancer www.P65Warnings.ca.gov

LIGHTING

Photos not actual size



23201

(1F1Z-14A411-BA, WPT-489,
88861093, PT2159,
3U2Z-14S411-RPA)

**Brake Lamp Switch, Parking
Lamp, Air Bag Crash
Sensor Repair Harness**

Gauge: 18
Two TXL 8" Leads
Switch: YF1Z-13480-BA, Sensor:
6L4Z-4B004-AA, Socket: 6R3Z-
13411-BA

Ford Taurus & Sable Station Wagons 2000 - On,
Explorer, Escape, Mariner,
Expedition, Navigator 2001 - On
Mustang 2004 - On

UNIT PACKAGE: 1



23216

(FITZ-13411-G,
88861080, LS215)

**Backup, Parking &
Stop Lamp Socket**

For 3156 Bulb
Use with 19126
Ford Cars & Trucks 1990 - On

UNIT PACKAGE: 1

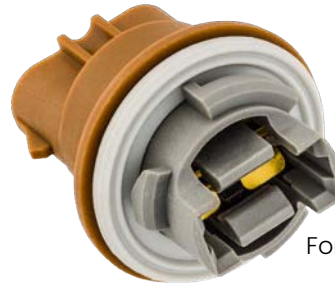

23217

(F47Z-13411-A,
88861082, LS217)

**Stop, Tail & Turn
Signal Lamp Socket**

For 3157 Bulb
Use with 23122
Ford Cars & Trucks 1994 - On

UNIT PACKAGE: 1



23213

(FITZ-13411-F,
88860591, LS184)

**Stop, Parking & Turn
Signal Lamp Socket**

For 3157 Bulb
Use with 19125 (95-7428)
Ford Cars & Trucks 1991 - On

UNIT PACKAGE: 1



23218

(F58Z-13411-A,
88861083, LS218)

Turn Signal Lamp Socket

For 3156 Bulb
Use with 23121
Ford Cars &
Trucks 1995 - 2004

UNIT PACKAGE: 1



23214

(FITZ-13411-E)

**Stop & Turn Signal
Lamp Socket**

For 3157 Bulb
Use with 19125
Ford Cars & Trucks 1997 - On

UNIT PACKAGE: 1



23219

(F37Z-13411-A,
88862300, PT2381)

**Backup & Stop/Tail
Lamp Socket**

For 3156 Bulb
Use with 23121 (96-7572)
Ford Cars &
Trucks 1993 - 2004

UNIT PACKAGE: 1

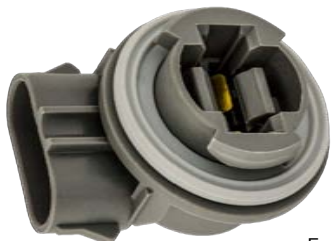

23215

(FITZ-13411-B,
88861079, LS214)

**Backup, Parking
& Stop Lamp Socket**

For 3156 Bulb
Use with 19126
Ford Cars & Trucks 1991 - On

UNIT PACKAGE: 1

WARNING: ALL ITEMS ON PAGE Reproductive Risk & Cancer www.P65Warnings.ca.gov

FORD SOCKET ASSEMBLY & HARNESS CONNECTORS

LIGHTING

Photos not actual size



25292
(Ford: 5T2Z-13411-A)
Gray Housing

Turn Signal Lamp Socket Base
Bulb No. 3157
Two Terminals
Use with Auveco No. 23060
Ford Escape 2016 - 2013

UNIT PACKAGE: 1



25293
(2U5Z-13411-WA)
Brown Housing

Turn Signal Lamp Socket Base
Bulb No. 3157
Three Terminals
Use with Auveco No. 23059
Ford Edge 2014 - 2011, Explorer 2019 - 2016,
F-250, 350, 450, 550 2016 - 2011
Lincoln MKX 2015 - 2011

UNIT PACKAGE: 1

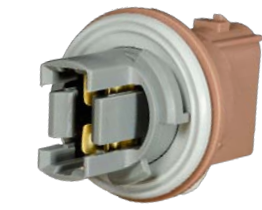

25296
(4F9Z-13411-A)
Brown Housing

Turn Signal & Back Up Lamp Socket
Bulb No. 3157
Three Terminals
Use with Auveco No. 23059
Ford Expedition 2014 - 2007, Explorer 2010 - 2006,
F-250, 350, 450, 550 2016 - 2011, Fusion 2012 - 2010,
Mustang Convertible 2019 - 2015, Taurus 2009 - 2008
Lincoln Navigator 2014 - 2007

UNIT PACKAGE: 1

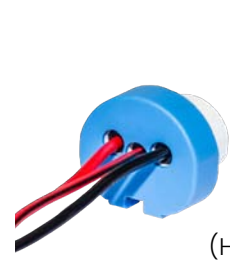

23229

Hi-Temp Headlight Socket Assembly

Gauge: 14
Three 6" Leads
For Hi-Intensity
(Hi-Heat output) Bulbs
For Bulb 9004 or 9007
Connector rated at 300°C/572°F

UNIT PACKAGE: 2



23230

Hi-Temp Headlight Socket Assembly

Gauge: 14
Two 6" Leads
For Hi-Intensity
(Hi-Heat output) Bulbs
Use with Bulbs 9005,
H10, H12
Connector rated at
300°C/572°F

UNIT PACKAGE: 2



23231

Hi-Temp Headlight Socket Assembly

Gauge: 14
Leads Length: 6"
For Hi-Intensity
(Hi-Heat output) Bulbs
For Bulb 9006
Connector rated at
300°C/572°F

UNIT PACKAGE: 2

AIR & FUEL

Photos not actual size



16968
(12085491)

Fuel Injector Solenoid Harness Connector
Fits GM Multi-Port Fuel Injector 1711799 on 2.8 and 3.1 liter engines (27 models) 1986 - On
Fits Fuel Injectors on Ford, Chrysler & Imports (Bosch)

UNIT PACKAGE: 1



18668
(Not Supplied by O.E.M.)

In-Tank Fuel Pump & Sending Unit Connector
Ford 1985 - On

UNIT PACKAGE: 5



20840
(Not Supplied by O.E.M.)

Glow Plug Pass thru at Valve Cover Gasket Harness Connector

Two 16 Gauge & Three 18 Gauge Wire Leads
Ford E350, F250-F550SD & Excursion 7.3 Diesel 1996 - On

UNIT PACKAGE: 1



20842
(Not Supplied by O.E.M.)

Fuel Injectors Harness Connector
One 16 Gauge & One 18 Gauge Wire Leads with Oval Injector Connectors
Ford 1999 - On

UNIT PACKAGE: 1



23032
(12085491, PT113, 12085490, PT112, 88862303, PT2384)

Fuel Injector Repair Harness Connector
Gauge: 18
Two 8" GXL Leads
Lucas & Bosch Injectors w/External Spring Clip Retainer
Domestic & Import Vehicles

UNIT PACKAGE: 1

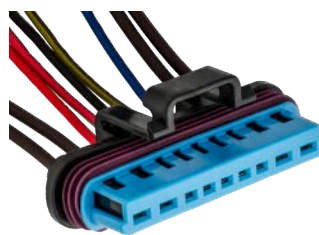

23062
(7U2Z-14S411-AA, WPT-886)

Injector/Glow Plug Pass through at valve Cover Gasket Repair Harness Connector
Five 18 Ga. & Four 14 Ga. TXL 8" Leads
Gasket: F81Z-6584-AA
Ford E & F Series Trucks 7.3 Diesel 1998 - On & Excursion 2000 - On

UNIT PACKAGE: 1



23096
(88861107, PT2164)

Fuel Injector Plug Repair Harness Connector
Gauge: 18
Two 8" SXL Leads
Lucas & Bosch Injectors w/External Spring Clip Retainer
Domestic & Import Vehicles

UNIT PACKAGE: 1



23156
(12102747, PT374, 88862226, PT2307, 13580106, PT2625, 3U2Z-14S411-CJAA, WPT-692)

A/C Pressure Cycling & Backup Lamp Switch, Wheel Speed Sensor, EGR Valve Control & Windshield Waser Pump, Fog Lamp Repair Harness Connector

Gauge: 16
Two GXL 8" Leads
Switch: 25604949
Pump: 22127653
GM Car & Truck 1987 - On, Ford 2000 - On, SAAB

UNIT PACKAGE: 1



23181
(12085485, PT107, 88862267, PT2348, 3U2Z-14S411-NZA, 3U2Z-14S411-SFA, WPT-494, WPT-564, 5019910AA)

Backup Lamp Switch, Speed Sensor, IAC Value Repair Harness Connector
Gauge: 12
Two SXL 8" Leads
Switch: 23049569, D2220A
GM Cars & Trucks 1971 - On, Ford Mustang 2001-2014

UNIT PACKAGE: 1

WARNING: ALL ITEMS ON PAGE Reproductive Risk & Cancer www.P65Warnings.ca.gov

FORD SOCKET ASSEMBLY & HARNESS CONNECTORS

AIR & FUEL

Photos not actual size



23191
(Not Available from OEM)

**Fuel Gauge Sensor
Repair Harness
Connector**

Gauge: 18

Two GXL 8" Leads

Connector: FIZZ-9A407-B, FIZZ-9A407-C,
E5ZZ-9A407-B, E5ZZ-9A407-A
Ford Mustang 1985 - 1997

UNIT PACKAGE: 1



23269
(3U2Z-14S411-HVA,
3U2Z-14S411- CDA,
WPT-657, WPT-304, 88861090,
PT2156, 5014002AA)

**Windshield Washer Pump,
IAC Valve, Coolant Temp,
Trans Speed Sensor
Repair Harness Connector**

Gauge: 16

Two TXL 8" Leads

Pumps: F6SZ-17664-BA, F6SU-17664-DA, WG300
IAC Valves: F65Z-9F715-EB, F75Z-9F715- AB
Ford Cars & Trucks 1995 - On, Chrysler 1997 - On

UNIT PACKAGE: 1

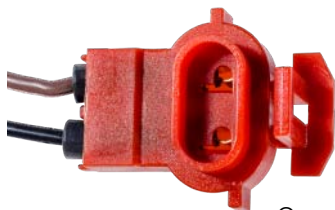

23192
(Not Available from OEM)

**Fuel Pump Assembly
Repair Harness
Connector**

Gauge: 14

Two GXL 8" Leads

Connector: FIZZ-9A407-B, FIZZ-9A407-C,
E5ZZ-9A407-B & E5ZZ-9A407-A
Ford Mustang 1985 - 1997

UNIT PACKAGE: 1



24202
(88988963, PT2183,
CU2Z-14S411-ARA, WPT-1302)

**Fuel Injector, Knock, Cam
Crank, Coolant Temp Sensor
Repair Harness Connector**

Gauge: 14

Two TXL 8" Leads

GM 2004 - 2014

Ford 2010 - 2016

UNIT PACKAGE: 1



23199
(88861094, PT2160,
1U2Z-14S411-BPA, WPT-159)

**Fuel Injectors, A/C
Compressor Clutch
Repair Harness Connector
with Oval Injector Connectors**

Bosch EV6 type

One 18 Gauge

One 16 Gauge

TXL 8" Leads

GM 1995 - On

Ford Cars & Trucks 4, 6, 8 & 10
Cyl. 1999 - On

UNIT PACKAGE: 1



25160
(CU2Z-14S411-UA;
WPT-1277;
90980-11875 - Connector
Only)

**Variable Timing Solenoid, Fuel
Injector, Knock Sensor Repair
Harness Connector**

2-18 ga. 8" Leads

Acura 2017- 2005; Chevrolet Prism 2002 - 1998;
Ford; Lincoln 2017 - 2011; Honda 2016 -2005;
Isuzu 2017 - 2004 Mercedes E-320 2000;
Pontiac Vibe 2010 - 2003; Scion 2015 - 2008;
Suzuki 2013 - 2009; Toyota 2017 - 1998

UNIT PACKAGE: 1

WARNING: ALL ITEMS ON PAGE Reproductive Risk & Cancer www.P65Warnings.ca.gov

FORD SOCKET ASSEMBLY & HARNESS CONNECTORS

CHARGING & STARTING

Photos not actual size



11445
Voltage Regulator
Harness Connector
Ford

UNIT PACKAGE: 10

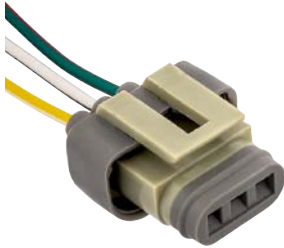

17659
(Not Supplied by O.E.M.)
Voltage Regulator Plug
Harness Connector
Sable, Taurus, Tempo
& Topaz with
Internal Voltage Regulator
1986 - On

UNIT PACKAGE: 1

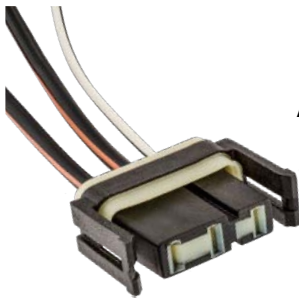

18218
(Not Supplied by O.E.M.)
Alternator Harness Connector
Ford Aerostar, Tempo, Topaz,
Taurus & Sable with
6 Cylinder Engine & 75 Amp
Alternator 1989-On
4 Cylinder Engine 1985-On

UNIT PACKAGE: 1

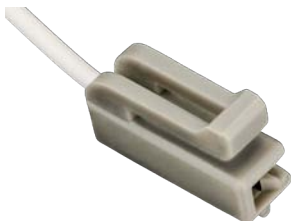

19156
(Not Supplied by O.E.M.)
Alternator Regulator &
Air Conditioner Clutch Field
Harness Connector
Ford 1994-On

UNIT PACKAGE: 10



20838
(Not Supplied by O.E.M.)
Alternator Harness Connector
Two 16 Gauge Wire Leads
100 Amp Alternator
Ford 1990 - 75

UNIT PACKAGE: 10



20846
(F4VY-14A411-S)
Starter Solenoid
In-line Repair
Harness Connector
12 Gauge Wire Lead
Ford & Lincoln Town Car
1997 - 91

UNIT PACKAGE: 1



20851
(1U2Z-14S411-TA, WPT118)
Alternator Harness Connector
Three 14 Gauge
Wire Leads
Ford 1996 - On

UNIT PACKAGE: 1

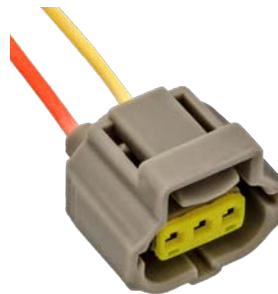

23098
(Not Available from OEM)
Alternator Repair
Harness Connector
Gauge: 16
Two TXL 8" Leads
Ford F250/350 7.3 Diesel Eng. &
Cr. Vic, Gr. Marquis,
Town Car, Contour
& Mystique 1996 - On

UNIT PACKAGE: 1

WARNING: ALL ITEMS ON PAGE Reproductive Risk & Cancer www.P65Warnings.ca.gov

FORD SOCKET ASSEMBLY & HARNESS CONNECTORS
HEATING & AIR CONDITIONING

Photos not actual size



17598
(Not Supplied by O.E.M.)
**Air Conditioning Clutch
Cycling Pressure Switch
Harness Connector**
Fits Switch E35Y-19E561-A
Ford 1980-On

UNIT PACKAGE: 1

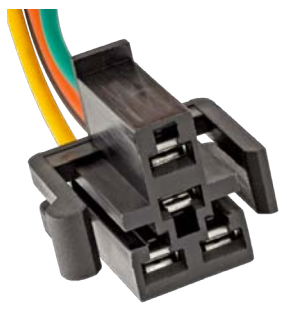

17620
(Not Supplied by O.E.M.)
**Air Conditioning Blower
Motor Resistor Assembly
Harness Connector**
Fits Resistor Assembly
E7TZ-19A706-A
Ford Trucks 1983 - On

UNIT PACKAGE: 1

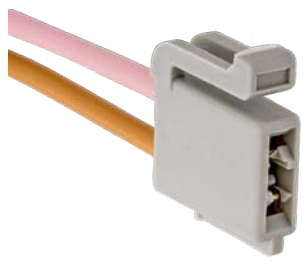

18671
(Not Supplied by O.E.M.)
**Air Conditioner
Clutch Field Coil
Harness Connector**
Ford

UNIT PACKAGE: 10



19156
(Not Supplied by O.E.M.)
**Alternator Regulator &
Air Conditioner Clutch Field
Harness Connector**
Ford 1994-On

UNIT PACKAGE: 10

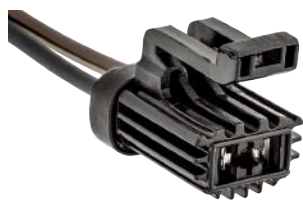

19582
(Not Supplied by O.E.M.)
**Harness Connector for
Heater Blower Motor &
Radiator Cooling Fan Motor**
Replaces Auveco 18213
Ford Truck & Vans 1986-82
Ford 4-Cylinder Engine
1979-On

UNIT PACKAGE: 5



19661
(Not Supplied by O.E.M.)
**Blower Motor Resistor
Harness Connector**
Fits Resistors F1CZ-19A706-A
& F7CZ-19A706-AA
One Connector has one each of 8"
Long 20 Gauge, 16 Gauge, 14 Gauge
& 12 Gauge GXL Wire Leads.
The other Connector has one 8" Long
12 Gauge GXL Wire Lead.
Ford Escort & Tracer 1991-On

UNIT PACKAGE: 1



20549
(Not Supplied by O.E.M.)
**Radiator Cooling Fan Motor
Harness Connector**
Fits Fan & Shroud Assemblies
F4DZ-8C607B &
F5CA-8C607A
Ford Contour, Continental,
Escort, Mystique,
Sable & Taurus 1997 - 90

UNIT PACKAGE: 1



20843
(F81Z-19D887-AA, WPT-169,
1U2Z-14S411-AEA)
**A/C Clutch Cycling
Pressure Switch
Harness Connector**
Four 16 Gauge Wire Leads
Fits Switches F5VY-19E561-A,
F3AZ-19D594-C,
F5TZ-19D594-AA & YH-592
Ford 1990 - On

UNIT PACKAGE: 1



20852
(Not Supplied by O.E.M.)
**Radiator Cooling
Motor & Resistor
Harness Connector**
Two 12 Gauge Leads
For Resistor F5RZ-8L603-AC &
Motors F8RZ-8C607-GC, GE, RF28, RF76 & RF81
Ford Contour, Mystique & Cougar 1995 - On

UNIT PACKAGE: 1

WARNING: ALL ITEMS ON PAGE Reproductive Risk & Cancer www.P65Warnings.ca.gov

FORD SOCKET ASSEMBLY & HARNESS CONNECTORS

Sec. 12

LIGHTING AND AIR & FUEL

Photos not actual size



23046

(12117025, PT420,
88862272, PT2353
3U2Z-14S411-UNA, WPT-763)

**Crank Position Sensor, Electric
Brake Module,
Engine Cooling Fan Motor,
Engine Coolant Level Switch &
Lamp Socket Repair Harness
Connector**

Gauge: 16
Three GXL 8" Leads
Sensor:10154687
GM Car & Truck 1990 - On
Ford

UNIT PACKAGE: 1

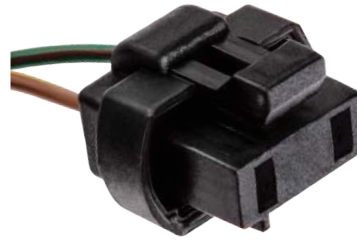

23168

(3U2Z-14S411-MGA,
WPT-438, 88860488,
88860518, PT1933,
PT1963)

**A/C Cycling Switch
Repair Harness
Connector**

Gauge: 16
Two 8" PVC Wire Leads
Switch: YH513, E35Y-19E561-A
All Ford 1983 - On

UNIT PACKAGE: 1

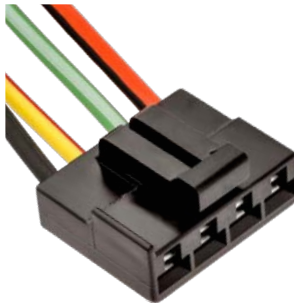

23051

(3U2Z-14S411-LJA, WPT-556,
88860576, PT2021)

**A/C Blower Switch
Repair Harness Connector**

Three 12 Ga. & One 10 Ga.
GXL 8" Leads
Switch: FOAZ-19986-C, YH510
Ford 1990 - 1994

UNIT PACKAGE: 1



23208

(1U2Z-14S411-AJA,
WPT-173)

**A/C Compressor Clutch
& Radio Antenna Repair
Harness Connector**

Gauge: 14
Two TXL 8" Leads
Ford 1995 - 2007

UNIT PACKAGE: 1

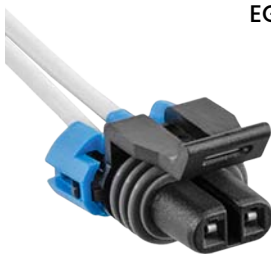

23156

(12102747, PT374, 88862226, PT2307, 13580106, PT2625,
3U2Z-14S411-CJAA, WPT-692)

**A/C Pressure Cycling & Backup
Lamp Switch, Wheel Speed Sensor,
EGR Valve Control & Windshield
Washer Pump, Fog Lamp
Repair Harness Connector**

Gauge: 16
Two GXL 8" Leads
Switch: 25604949
Pump: 22127653
GM Car & Truck 1987 - On,
Ford 2000 - On, SAAB

UNIT PACKAGE: 1



23212

(F5RZ-14A411-AA,
F6RZ-14A411-BA,
3U2Z-14S411-PGA, WPT-480,
88860548, PT1993)

**Blower Motor Switch &
Resistor Repair
Harness Connector**

Gauge: 12
Four GXL 8" Leads

Switches: F5RZ-18578-A, F7RZ-18578-DA
Resistors: F5RZ-18591-A, YH1722,
3M5Z-18591-BA, YH1696
Ford Contour/Mystique 1995 - 2000
Cougar 1999 - 2002
Transit Connect 2010 - On

UNIT PACKAGE: 1

WARNING: ALL ITEMS ON PAGE Reproductive Risk & Cancer www.P65Warnings.ca.gov

FORD SOCKET ASSEMBLY & HARNESS CONNECTORS

IGNITION

Photos not actual size



17112
(Not Supplied By O.E.M.)
Distributor Module Pigtail
Used on GM distributor module 1987466 on 6 cylinder 2.8 engines 1985-On

UNIT PACKAGE: 1

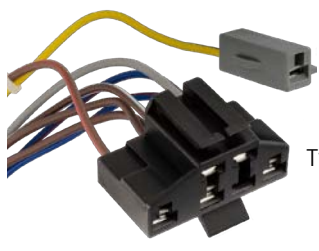

17623
(Not Supplied by O.E.M.)
EEC IV Test Plug Repair Harness Connector
Two Connectors with eight 18 Gauge Leads Ford 1983-On

UNIT PACKAGE: 1

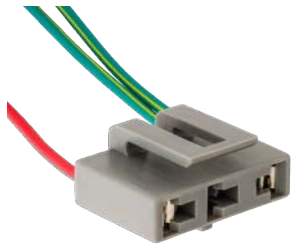

17661
(Not Supplied by O.E.M.)
Electronic Ignition Coil Harness Connector
Fits Coil E73Z-12029A Ford 1986-On

UNIT PACKAGE: 1



18217
(E5ZZ-12A209A)
Ignition Module & Neutral Safety Switch Harness Connector
For E.E.C. IV Ignition 1995-83 Ford Neutral Safety Switch E80Z-7A247-A 1988-On

UNIT PACKAGE: 1



18867
(12101880)
Direct Ignition Harness Connector
GM 1987-On

UNIT PACKAGE: 1

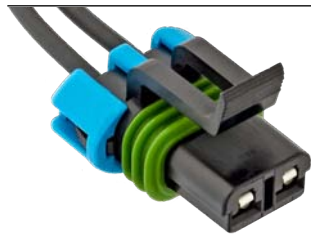

18870
(12101855)
Direct Ignition Vehicle Speed Sensor Harness Connector
GM 1987-On

UNIT PACKAGE: 1



18916
(12085483)
Ignition Module, Crankshaft Coolant Sensor & Power Steering Pressure Switch Harness Connector
GM 1986-On

UNIT PACKAGE: 1

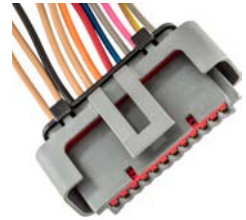

19623
(Not Supplied by O.E.M.)
Ignition Control Module Harness
For Modules FIAZ, F4SZ-12072A & F5SZ-12072AA Wire Gauge: 5 of 18 & 7 of 16 8" Leads
Ford: Full Size Trucks & Vans, T-Bird, Cougar Lincoln Town & Mark 1991 - On

UNIT PACKAGE: 1



20839
(Not Supplied by O.E.M.)
Coil to Ignition Harness Connector
Two 18 Gauge Wire Leads Ford 1977 - On

UNIT PACKAGE: 10



20841
(Not Supplied by O.E.M.)
Electronic Ignition Module Harness Connector
Four 18 Gauge Wire Leads Fits Module F2PZ-12A199-AA, DY683 Ford Cars & Lt. Trucks 1985 - 75 700 Series & Larger 1991 - 75

UNIT PACKAGE: 1



20844
(Not Supplied by O.E.M.)
Electronic Ignition Module Harness Connector
Four 16 Gauge Wire Leads Fits Modules F2PZ-12A199-AA, DY683 Ford 1975 - On

UNIT PACKAGE: 1



20853
(Not Supplied by O.E.M.)
Ignition Coil Harness Connector
Two 16 Gauge Wire Leads Fits Coils F7TZ-12029-CC & 1L2Z-12029-AA Ford Cars & Lt. Duty Trucks 1999 - On

UNIT PACKAGE: 1

WARNING: ALL ITEMS ON PAGE Reproductive Risk & Cancer www.P65Warnings.ca.gov

MSICELLANEOUS

Photos not actual size



17110
(12102747)

Windshield Washer Pump,
Low Coolant Sensor
Harness Connector
GM Cars & Trucks 1992-87

UNIT PACKAGE: 1



17621
(Not Supplied by O.E.M.)

Windshield Washer
Pump Harness Connector
Fits Pumps E0AZ-17664-A &
E30Z-17664-A
Ford 1968 - On

UNIT PACKAGE: 1



19076
(Not Supplied by O.E.M.)

Master Cylinder,
Door Jamb Switch
& Power Mirror
Harness Connector
Ford 1987-On

UNIT PACKAGE: 1

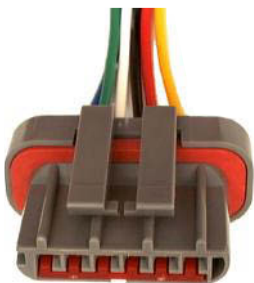

19885
(F4PZ-14A411C)

Windshield Wiper Motor
Harness Connector
For New Single Connector
Replacement Motors
(6 Positions)
Ford 1987-On

UNIT PACKAGE: 1

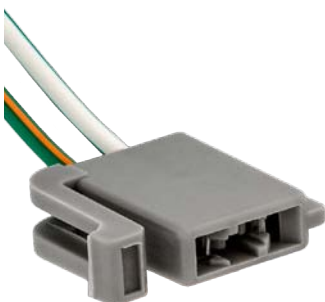

23024
(3U2Z-14S411-GJA,
5U2Z-14S411-DA,
5U2Z-14S411-DB, WPT-416,
WPT-843, WPT-1110)

Radio Speaker
Repair Harness Connector
Gauge: 18
Two GPT 8" Leads
Ford 1989 - On

UNIT PACKAGE: 5



23046
(12117025, PT420, 88862272,
3U2Z-14S411-UNA,
PT2353, WPT-763)

Crank Position Sensor,
Electric Brake Module,
Engine Cooling Fan Motor,
Engine Coolant Level Switch,
Lamp Socket Repair Harness
Connector

Gauge: 16
Three GXL 8" Leads
GM Car & Truck 1990 - On Ford

UNIT PACKAGE: 1



23064
(3U2Z-14S411-JLA,
WPT292, WPT830,
5C3Z-14S411-AA)

Vehicle Speed Sensor,
Relays, Switches, Lamps,
Pumps & Motors
Repair Harness Connector

Gauge: 16
Two TXL 8" Leads
Sensors: 6L3Z-9E731-A,
DY-1073
Ford, Lincoln & Mercury Cars &
Lt Duty Trucks 2000- On

UNIT PACKAGE: 1



23071
3U2Z-14S411-LKA,
WPT-615, 5017112AA

Data Link for OBDII Harness Connector Kit
Contents: 1-Connector (12110250), 2 Locks,
Six 16 Ga., Six 20 Ga. & Two 22 Ga.

TXL 8" Leads
All Cars & Lt Duty Trucks
Built in the U.S. 1995 - On

UNIT PACKAGE: 1

23156
(12102747, PT374, 88862226, PT2307, 13580106, PT2625,
3U2Z-14S411-CJAA, WPT-692)

A/C Pressure Cycling & Backup
Lamp Switch, Wheel Speed Sensor,
EGR Valve Control & Windshield
Waser Pump, Fog Lamp
Repair Harness Connector

Gauge: 16
Two GXL 8" Leads
Switch: 25604949
Pump: 22127653
GM Car & Truck 1987 - On
Ford 2000 - On
SAAB

UNIT PACKAGE: 1

WARNING: ALL ITEMS ON PAGE Reproductive Risk & Cancer www.P65Warnings.ca.gov

**FORD SOCKET ASSEMBLY & HARNESS CONNECTORS
MISCELLANEOUS, RELAYS, AND RH LIGHTING**

Photos not actual size

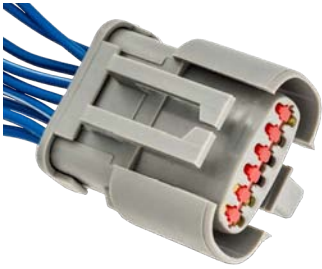

23193

(F2PZ-14A464-B,
3U2Z-14S411-VNA,
WPT-571, 88861076,
PT2148)

**Transmission Solenoid
Assembly Repair
Harness Connector**

Two 16 Ga. & Seven 18 Ga.
TXL 8" Leads

Solenoids: F5TZ-7G391-A,
F7TZ-7G391-AA, F8TZ-7G391-BA
Ford 'E', 'F', 'U150', Expedition &
Navigator w/E4OD Trans. 1990 - 1998

UNIT PACKAGE: 1



20172

(Not Supplied by O.E.M.)

EEC Relay Harness Connector
Used with Relay E3AZ-12A646-A
Two 18 Gauge Wire Leads,
Two 16 Gauge Wire Leads &
One 14 Gauge Wire lead
Ford Cars & Trucks 1981-On

UNIT PACKAGE: 1

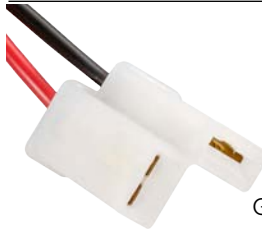

22771

(12126032; PT663)

**Signal Flasher & Relay
Repair Harness Connector**

Two 20 ga. 6" Leads
GM, Ford, Chrysler & Import Cars
& Trucks 2002 - 1956

UNIT PACKAGE: 1



23269

(3U2Z-14S411-HVA,
3U2Z-14S411- CDA,
WPT-657, WPT-304, 88861090,
PT2156, 5014002AA)

**Windshield Washer Pump, IAC
Valve, Coolant Temp, Trans
Speed Sensor
Repair Harness Connector**

Gauge: 16

Two TXL 8" Leads

Pumps: F6SZ-17664-BA, F6SU-17664-DA, WG300
IAC Valves: F65Z-9F715-EB, F75Z-9F715-AB
Ford Cars & Trucks 1995 - On; Chrysler 1997 - On

UNIT PACKAGE: 1

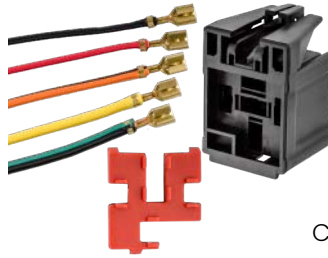

23186

(3U2Z-14S411-ZVA,
3U2Z-14S411-TAA,
WPT-662, WPT-802,
88860547, PT1992)

**Horn & Blower Relay
Harness Connector Kit**

Contains: 1 Connector, 1 Lock
One Each: 10 Ga., 12 Ga.,
14 Ga., 16 Ga., 18 Ga.
SXL 4" Leads

Relay: FOA8-14B193-AB
Ford Cars & Trucks

UNIT PACKAGE: 1



23437

(3U2Z-14S411-JFA,
3U2Z-14S411-EPAA, WPT-288,
WPT-719, 88860557, PT2002)

**Washer Pump Repair
Harness Connector**

Gauge: 16

Two GPTL 8" Leads

Pumps: E4TZ-17664-A,
E5TZ-17664-B
F19Z-17664-A &
E6S3-17664-CA,
22048650, 22049373

Ford Car & Truck 1984 - On
GM Cars & Lt. Duty Trucks 1982 - 1992

UNIT PACKAGE: 1

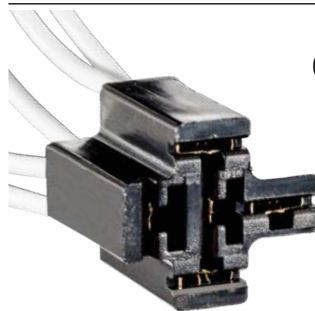

23196

(12102696, 88861106, 89057715,
88862254, PT363, PT1842,
PT2163, PT2335)

**Universal 5 Blade Relay
Repair Harness Connector**

Gauge: 16

Four GXL 8" Leads

GM 1980 - On
& General Purpose

UNIT PACKAGE: 1

RELAYS



17622

(Not Supplied by O.E.M.)

**Fuel Pump Relay Assembly
Harness Connector**

Fits Relay Assembly

E3FZ-9345-B

Ford 1983 - On

UNIT PACKAGE: 1

RH LIGHTING



23209

(Not Available from OEM)

Halogen Headlight Socket Assembly

Gauge: 12

One 12" GXL Lead

Right Angle for 1/4" Male Spade Terminals

For H1 & H3 Halogen Bulbs

Ford & General Purpose

UNIT PACKAGE: 1

WARNING: ALL ITEMS ON PAGE Reproductive Risk & Cancer www.P65Warnings.ca.gov

SENSORS

Photos not actual size



16693

(12046624, 12102620)

Replacement Harness Connector used with 1985-on GM Manifold

Air Temperature Sensors including 25036751. Features two 9" long 18 gauge wire leads.

UNIT PACKAGE: 1



18527

(12102748)

Throttle Position Sensor Harness Connector
GM 1994-90

UNIT PACKAGE: 1



17110

(12102747)

Windshield Washer Pump, Low Coolant Sensor Harness Connector
GM Cars & Trucks 1992-87

UNIT PACKAGE: 1



18870

(12101855)

Direct Ignition Vehicle Speed Sensor Harness Connector
GM 1987-On

UNIT PACKAGE: 1



17683

(Not Supplied by O.E.M.)

Coolant Temperature Sensor Harness Connector
Fits Sensor EIAZ-12A648A
Ford 1981-On

UNIT PACKAGE: 1



18916

(12085483)

Ignition Module, Crankshaft Coolant Sensor & Power Steering Pressure Switch Harness Connector
GM 1986-On

UNIT PACKAGE: 1



18215

(Not Supplied by O.E.M.)
Black Shell

Exhaust Oxygen Sensor Harness Connector

Fits Sensors
F0SZ-9F472-A & B,
F0TZ-9F472-B & E,
F02Z-9F472-C &
F03Z-9F472-A
Ford 1995-89

UNIT PACKAGE: 1



19004

(F2PZ-14A464C,
F4UB-14A464A)

Transmission MLP Sensor Harness Connector
E150/350, F250/350 &
U150 (Bronco)
1990-On

UNIT PACKAGE: 1



18216

(Not Supplied by O.E.M.)
Gray Shell

Exhaust Oxygen Sensor Harness Connector

Fits Sensors F0TZ-9F472-A & C,
F09Z-9F472-A & C,
F1SZ-9F472-A & FIUZ-9F472-C
Ford 1995-89

UNIT PACKAGE: 1



19157

(Not Supplied by O.E.M.)

Variable Speed Sensor Harness Connector
For Speed Sensors with
Ford Base No. 9E731
Ford 1993-On

UNIT PACKAGE: 1

WARNING: ALL ITEMS ON PAGE Reproductive Risk & Cancer www.P65Warnings.ca.gov

SENSORS

Photos not actual size



19880
(Not Supplied by O.E.M.)

**Transmission Gear Shift
Position Sensor
Harness Connector**
Eight Wire Leads

Used with Switch F5TZ-7A247
on Ford Trucks with E 4 OD Transmission,
RWD 1989-84 and E, F & U Series 1989-On

UNIT PACKAGE: 1



19882
(12085485)

**Back-Up Light Switch &
Speed Sensor Harness Connector**

Used with Switch 23049569,
PT107 & IACV Motor
GM 1971-On

UNIT PACKAGE: 1

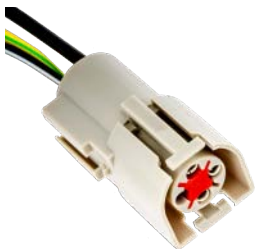

19889

(Not Supplied by O.E.M.)

**Exhaust Oxygen Sensor
Harness Connector**

Used with 3 Wire O2 Sensors
(Base No. 9F472)
Ford 1986-On

UNIT PACKAGE: 1



20845

(Not Supplied by O.E.M.)

**Cam Shaft &
Crank Shaft Sensors
Harness Connector**

Two 18 Gauge Leads
Fits Sensors F0CZ-6B288-A,
F1AZ-6B288-A, F1AZ-6C315-A &
XC3Z-6B288-AA
Ford 1991 - On

UNIT PACKAGE: 1

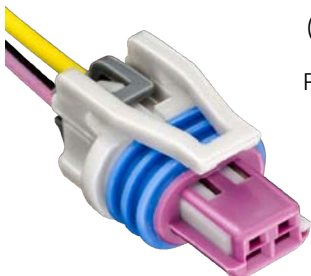

23016

(12046623, 12101899, 12126469,
15306031, 88987993, PT169,
PT739, PT1158, PT1798, WPT-751,
3U2Z-14S411-EMMA)

**Coolant Temp & Speed
Sensor Repair Harness
Connector**

Gauge: 18
Two 12" Leads
Sensors: 25036708, 25036979
Crank Sensors: 1103703, 1103661,
10456043
GM 1985 - On
Ford

UNIT PACKAGE: 1

WARNING: ALL ITEMS ON PAGE Reproductive Risk & Cancer www.P65Warnings.ca.gov



23020

(12126487, PT757, 19115673,
PT2203, 19257375, PT2605,
88862215, PT2296,
3U2Z-14S411-SCA, WPT-704,
8U2Z-14S411-DA, WPT-915)

**Distributor Module
Repair Harness Connector**

Gauge: 18
Four TXL 8" Leads
Module: 1987466, GM 1985 - 1992
Ignition Coil: 12558693,
Lt. Duty GM Trucks 1999 - 2007
Crank Sensor: 25526124, 25535481, 25526122
GM w/2.8 Eng. 1985 - On, w/3.8 1988 - On
IAC Valves, GM 1987 - 2007 & Chrysler 1986 - 1995
Door jamb switch, Ford 2003 - 2007

UNIT PACKAGE: 1



23033

(3U2Z-14S411-FUA, WPT-263,
88860490, PT1935)

**Map Sensor Repair
Harness Connector**

Gauge: 18
Three GPT 8" Leads
Ford Vehicles 1985 - On

UNIT PACKAGE: 1



23034

(12102748, PT375,
12126473, PT743, 88862238,
PT2319, 5C3Z-12224-A)

**Throttle Position,
Fuel Injection Timing &
EGR Pressure
Feedback Sensor
Repair Harness Connector**

Gauge: 20
Three TXL 8" Leads
Throttle Sensor: 17112679, 17106681, 17123852
Fuel Sensor: 3C3Z-9F838-AA,
3C3Z-9F838-EA & 4C3Z-9J460-A
GM 1990 - On
Ford 'F' Super Duty & Excursion 6.0 1999 - 2007

UNIT PACKAGE: 1

SENSORS

Photos not actual size

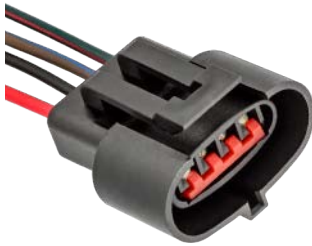

23039

(3U2Z-14S411-ACA, WPT-207, 88860508, PT1953)

Mass Air Flow Sensor, Ignition Coil Repair Harness Connector
One 16 Ga. & Three 18 Ga.
GXL 8" Leads

Sensor w/Base: 12B579

Coil: F0TZ-12029-A, FISZ-12029-A, F5SZ-12029-A
Ford Vehicles 1989 - 1992

UNIT PACKAGE: 1



23043

(88860522, PT1967)

Exhaust Oxygen Sensor Repair Harness Connector
One 12 Ga. & Two 16 Ga.
GXL 8" Leads
Base: 9F472
Ford Vehicles 1986 - On

UNIT PACKAGE: 1

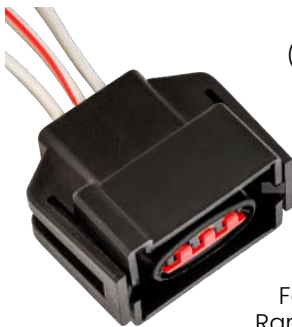

23040

(3U2Z-14S411-NLA, WPT-445, 88860520, PT1965)

Throttle Position Sensor Repair Harness Connector
Gauge: 18
Three GPT 8" Leads

Sensor Base: 9B989

Ford Taurus, Sable 1990 - On
Ranger, Explorer, Escort 1991 - On
Crown Victoria/Marquis 1992 - On

UNIT PACKAGE: 1



23046

(12117025, PT420, 88862272, 3U2Z-14S411-UNA, PT2353, WPT-763)

Crank Position Sensor, Electric Brake Module, Engine Cooling Fan Motor, Engine Coolant Level Switch, Lamp Socket Repair Harness Connector
Gauge: 16
Three GXL 8" Leads

GM Car & Truck 1990 - On Ford

UNIT PACKAGE: 1

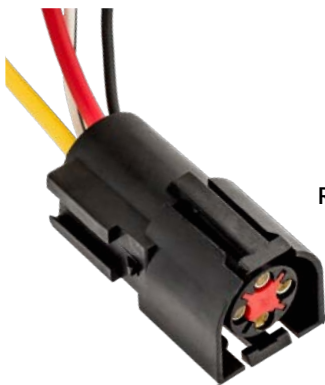

23042

(3U2Z-14S411-DRA, 3U2Z-14S411-DGA, WPT-386, WPT-427)

Exhaust Oxygen Sensor Repair Harness Connector
One 18 Ga., One 16 Ga. & Two 12 Ga.
GXL 8" Leads

Base: 9F472

Ford Vehicles 1990 - On

UNIT PACKAGE: 1



23055

(3U2Z-14S411-EKA, 4U2Z-14S411-RA, WPT-254, WPT-837)

Rear AXL Speed Sensor, Backup & Stop Lamp Socket Repair Harness Connector
Gauge: 20
Two TXL 8" Leads

Sensors: 1L2Z-9E731-AA, 1L2Z-9E731-AA, DY887, DY1000

Socket: 6E5Z-13411-AA
Ford Explorer/Mountaineer & Aviator 2002 - On
Ford Fusion, Zephyr, MKZ, Milan 2006 - On

UNIT PACKAGE: 1

WARNING: ALL ITEMS ON PAGE Reproductive Risk & Cancer www.P65Warnings.ca.gov

FORD SOCKET ASSEMBLY & HARNESS CONNECTORS

SENSORS

Photos not actual size



23064

(3U2Z-14S411-JLA, WPT292, WPT830, 5C3Z-14S411-AA)

Vehicle Speed Sensor, Relays, Switches, Lamps, Pumps & Motors Repair Harness Connector

Gauge: 16
Two TXL 8" Leads
Sensors: 6L3Z-9E731-A, DY-1073
Ford, Lincoln & Mercury Cars & Lt Duty Trucks 2000- On

UNIT PACKAGE: 1



23181

(12085485, PT107, 88862267, PT2348, 3U2Z-14S411-NZA, 3U2Z-14S411-SFA, WPT-494, WPT-564, 5019910AA)

Backup Lamp Switch, Speed Sensor, IAC Value Repair Harness Connector

Gauge: 12
Two SXL 8" Leads
Switch: 23049569, D2220A
GM Cars & Trucks 1971 - On
Ford Mustang 2001-2014

UNIT PACKAGE: 1

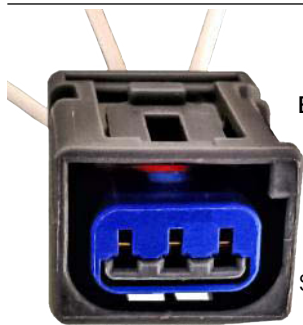

23067

(3U2Z-14S411-KMA, WPT-393)

EGR Valve, Pressure Feedback Sensor, Fuel Tank Pressure Transducer Repair Harness Connector

Gauge: 18
Three TXL 8" Leads
Sensor: 4U7F-9J460-AA, DPFE4, 8C3Z-9J460-B, DPFE9
Ford Cars & Lt Duty Trucks 2001 - On

UNIT PACKAGE: 1



23201

(1F1Z-14A411-BA, WPT-489, 88861093, PT2159, 3U2Z-14S411-RPA)

Brake Lamp Switch, Parking Lamp, Air Bag Crash Sensor Repair Harness

Gauge: 18
Two TXL 8" Leads
Switch: YF1Z-13480-BA, Sensor: 6L4Z-4B004-AA, Socket: 6R3Z-13411-BA

Ford Taurus & Sable Station Wagons 2000 - On, Explorer, Escape, Mariner, Expedition, Navigator 2001 - On, Mustang 2004 - On

UNIT PACKAGE: 1



23119

(88861072, PT2144)

EGR Sensor Repair Harness Connector

Gauge: 18
Three GXL 8" Leads
Sensors: E2TZ-9G428-A, E5AZ-9G428-A, E7TZ-9G428-A, F2ZZ-9G428-B, F2ZE-9G428-BA
Ford Cars & Trucks 1985 - 1997

UNIT PACKAGE: 1



23202

(3U2Z-14S411-CEAA, 3U2Z-14S411-FGAA, 3U2Z-14S411-CEAB, WPT-803, WPT-806, WPT-996, 88861085, PT2152)

Transmission Lever Position Sensor Repair Harness Connector

Gauge: 16
Twelve TXL 8" Leads
Sensor: F7TZ-7F293-AA
Ford Lt. & Med. Duty Trucks With 4R100 Trans. 1997 - On

UNIT PACKAGE: 1



23156

(12102747, PT374, 88862226, PT2307, 13580106, PT2625, 3U2Z-14S411-CJAA, WPT-692)

A/C Pressure Cycling & Backup Lamp Switch, Wheel Speed Sensor, EGR Valve Control & Windshield Waser Pump, Fog Lamp Repair Harness Connector

Gauge: 16
Two GXL 8" Leads
Switch: 25604949
Pump: 22127653
GM Car & Truck 1987 - On
Ford 2000 - On
SAAB

UNIT PACKAGE: 1

WARNING: ALL ITEMS ON PAGE Reproductive Risk & Cancer www.P65Warnings.ca.gov

SENSORS

Photos not actual size

23204

(PT2482, 1U2Z-14S411-AFA,
3U2Z-14S411-EYAA,
WPT-170, WPT-754)



**Throttle Position Sensor
Repair Harness Connector**
Gauge: 14
Three TXL 8" Leads
Sensors: F80Z-9B989-AA,
F4SZ-9B989-A,
DY968, CX1488
Ford Cars &
Lt. Duty Trucks 1995 - On

UNIT PACKAGE: 1

23206

(2U2Z-14S411-AA, WPT-188)



**PFE/EGR Sensor
Repair Harness Connector**
Gauge: 14
Three 8" TXL Leads
Base: 9J460
Sensor: F7UZ-AA,
F77Z-AB, YFIZ-AB,
YFIZ-AC, YS4Z-AA, 2FIZ-AA
Ford Cars &
Lt. Duty Trucks 1992 - On

UNIT PACKAGE: 1

23269

(3U2Z-14S411-HVA,
3U2Z-14S411-CDA,
WPT-657, WPT-304, 88861090,
PT2156, 5014002AA)



**Windshield Washer Pump, IAC
Valve, Coolant Temp, Trans
Speed Sensor
Repair Harness Connector**
Gauge: 16
Two TXL 8" Leads
Pumps: F6SZ-17664-BA, F6SU-17664-DA, WG300
IAC Valves: F65Z-9F715-EB, F75Z-9F715-AB
Ford Cars & Trucks 1995 - On; Chrysler 1997 - On

UNIT PACKAGE: 1



23271

(3U2Z-14S411-VA, WPT-206,
3U2Z-14S411-HYA, WPT 284,
3U2Z-14S411-HYB,
WPT-989, 5014003AA)

**Coolant & Air Temp Sensor,
Brake Fluid Level Sensor
Repair Harness Connector**
Gauge: 14
Two TXL 8" Leads
Sensor: F5AZ-12A648-AB,
3FIZ-12A648-A, DY719, DY1144
Ford Cars & Trucks 1995 - On, Chrysler 1997 - On

UNIT PACKAGE: 1

24202

(88988963, PT2183,
CU2Z-14S411-ARA, WPT-1302)



**Fuel Injector, Knock, Cam
Crank, Coolant Temp Sensor
Repair Harness Connector**
Gauge: 14
Two TXL 8" Leads
GM 2004 - 2014
Ford 2010 - 2016

UNIT PACKAGE: 1

25192

(3U2Z-14S411-FZA)

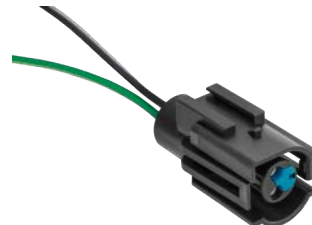

Air Temp Sensor Harness
2-18 Ga.
8" Wire Leads
Ford Aerostar, Crown Victoria, Ranger 1997 - 1986,
Bronco 1995 - 1986, Contour, Mystique 2000 - 1995,
E-Vans 1996 - 1986, Escort 1995 - 1981,
Explorer 2005 - 1991, F-Pickup & SD 2012 - 1985, Fairmont,
Zephyr 1983 - 1981, Festiva 1992 - 1988, Freestar,
Monterey 2007 - 2004, Granada 1982 - 1981, LTD 1991 -
1982, Mustang 2004 - 1981,
Probe 1995 - 1989, Ranger 1994 - 1985,
Taurus 2007 - 1986, Tempo, Topaz 1994 - 1984,
Thunderbird, Cougar, Grand Marquis 1997 - 1981,
Windstar 2003 - 1995, Continental 1994 - 1993,
Mark VI, VII, VIII 1998 - 1980, Town Car 1994 - 1982 Capri
1994, LN7, Lynx 1987 - 1981,
Marquis 1984 - 1981, Mountaineer 2001 - 1997, Sable
2005 - 1986; Tracer 1996 - 1987, Villager 1995 - 1993;
Mazda B2300, B3000, B4000 1994

UNIT PACKAGE: 1

WARNING: ALL ITEMS ON PAGE Reproductive Risk & Cancer www.P65Warnings.ca.gov

FORD SOCKET ASSEMBLY & HARNESS CONNECTORS

SWITCHES

Photos not actual size



11437
**Dimmer Switch
 Harness Connector**
 Ford & Chrysler

UNIT PACKAGE: 10



18463
 (Not Supplied by O.E.M.)
**Headlight Switch
 Harness Connector**
 Fits Headlight Switches
 E6DZ-11654A & F2DZ-11654A
 Ford Taurus & Mercury Sable
 with Rotary Knob 1994-86

UNIT PACKAGE: 1



13644
Right Angle Pigtail
 General Purpose
 11-1/2" Wire Lead for .160 Stud
 Ford

UNIT PACKAGE: 10

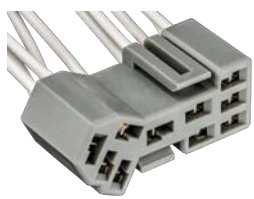

18673
 (Not Supplied by O.E.M.)
**Multi-Function Switch
 Harness Connector**
 (Turn Signal & Windshield Wiper)
 Fits Switch E9DZ-13K359-A, B, C,
 E8ZZ-13K359-B & F0ZZ-13K359-A
 Ford Mustang 1993-87
 Taurus & Sable 1989-86

UNIT PACKAGE: 1

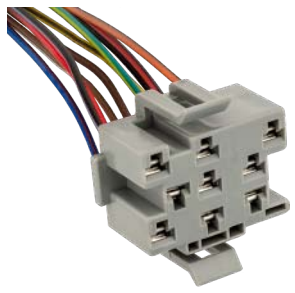

17624
 (Not Supplied by O.E.M.)
**Headlight Switch Assembly
 Harness Connector**
 Fits Instrument Panel
 Headlight Switch
 E7TZ-11654-C
 Ford Trucks: F150, F250, F350 &
 Bronco 1991-87

UNIT PACKAGE: 1

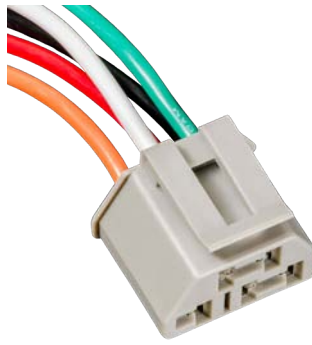

18819
 (Not Supplied by O.E.M.)
**Heater & Air Conditioner
 Blower Switches
 Harness Connector**
 Fits most Ford Switches with
 Base Number 19986
 1973-On

UNIT PACKAGE: 1

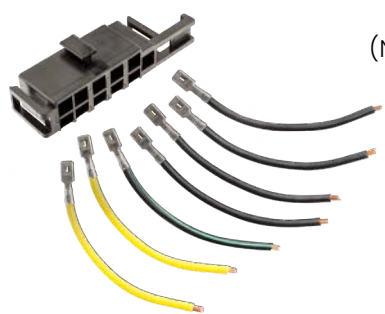

17684
 (Not Supplied by O.E.M.)
**Ignition Switch
 Harness Connector**
 Fits Ignition Switch
 E6FZ-11572A
 Ford 1992-80

UNIT PACKAGE: 1



18916
 (12085483)
**Ignition Module, Crankshaft
 Coolant Sensor & Power
 Steering Pressure Switch
 Harness Connector**
 GM 1986-On

UNIT PACKAGE: 1

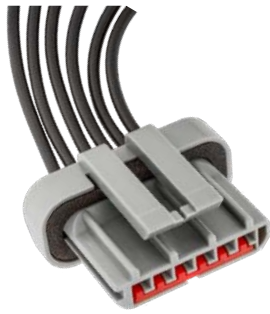

18217
 (E5ZZ-12A209A)
**Ignition Module &
 Neutral Safety Switch
 Harness Connector**
 For E.E.C. IV Ignition 1995-83
 Ford Neutral Safety Switch
 E80Z-7A247-A 1988-On

UNIT PACKAGE: 1



19076
 (Not Supplied by O.E.M.)
**Master Cylinder,
 Door Jamb Switch
 & Power Mirror
 Harness Connector**
 Ford 1987-On

UNIT PACKAGE: 1

SWITCHES

Photos not actual size



19813
(D1AZ-13410-A)

**Power Brake
Harness Connector**
Ford 1965-On

UNIT PACKAGE: 10



20246
(Not Supplied by O.E.M.)

**Multi-Function Switch
Repair Harness**
Eleven 18 Gauge Leads
Aerostar, E Van, Expedition,
Mustang, Navigator, Sable,
Taurus & Windstar 1992 - On

UNIT PACKAGE: 1



19881
(Not Supplied by O.E.M.)

**Ignition Switch
Harness Connector**
Used with Switches
DOTZ-11572A, SW944
Ford Trucks: 100-900 Series
1970-On

UNIT PACKAGE: 1



20277
(Not Supplied by O.E.M.)

**Heater/Air Conditioner
Fan Speed Switch
Harness Connector**
Two 12 Gauge, one 14 Gauge &
One 16 Gauge Leads
Fits Switches E6DZ-A, E9SZ-A,
F2DZ-A & F2UZ-19986A,B

Ford Cougar, E Van, Mustang, Sable,
Taurus & T-Bird 1986 - On

UNIT PACKAGE: 1



19882
(12085485)

**Back-Up Light Switch &
Speed Sensor Harness Connector**
Used with Switch 23049569,
PT107 & IACV Motor
GM 1971-On

UNIT PACKAGE: 1



20547
(Not Supplied by O.E.M.)

**Multi-Function Switch
Harness Connector**
Fits 13K359 Switches E8DZ-B,
E8ZZ-B, E9DZ-A,B,C, E90Y-D,
E9SZ-B,D,E & F0ZZ-A,B
Ford Taurus, Sable, T-Bird, Cougar
and Continental 1993 - 86

UNIT PACKAGE: 1

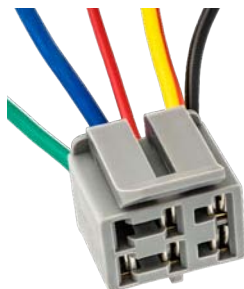

19887
(Not Supplied by O.E.M.)

**Auxiliary Blower Switch
Harness Connector**
Fits Switch F2UZ-19986C, YH-538
Ford Vans E150/350 1992-On

UNIT PACKAGE: 1

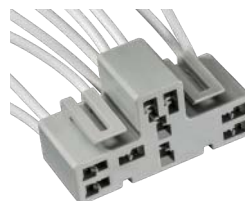

20548
(Not Supplied by O.E.M.)

**Multi-Function Switch
Harness Connector**
Fits 13K359 Switches E8DZ-B,
E8ZZ-B, E9DZ-A, B, C, E90Y-D,
E9SZ-B, D, E & F0ZZ-A, B
Ford Taurus, Sable, T-Bird, Cougar and
Continental 1993 - 86

UNIT PACKAGE: 1



19890
(Not Available from O.E.M.)

**Back-Up Light Switch
Harness Connector**
Fits Switches
C9TZ-15520C & SW-849
Ford Trucks & T-Bird 1967-On

UNIT PACKAGE: 1

WARNING: ALL ITEMS ON PAGE Reproductive Risk & Cancer www.P65Warnings.ca.gov

SWITCHES

Photos not actual size



20550

(Not Supplied by O.E.M.)

**Multi-Function Switch
Harness Connector**

Fits 13K359 Switches
F1AZ-A, B, F1DZ-B, F1LY-B,
F1OY-D, F1VY-C, F3TZ-B, F3UZ-C,

F4ZZ-AA, F58Z-A, F5AZ-A, F5TZ-B, F65Z-AA, F6DZ-A, F75Z-
AB,AC,BA, F77Z-AA, F79Z-CA & F85Z-AA
Ford Aerostar, Bronco, Continental, Cougar, Expedition,
Explorer, F Pick-Ups, Mark Series, Mountaineer, Mustang,
Navigator, Ranger, Sable, T-Bird, Taurus, Town Car &
Windstar 1990 - On

UNIT PACKAGE: 1



23020

(12126487, PT757, 19115673,
PT2203, 19257375, PT2605,
88862215, PT2296,
3U2Z-14S411-SCA, WPT-704,
8U2Z-14S411-DA, WPT-915)

**Distributor Module
Repair Harness Connector**

Gauge: 18
Four TXL 8" Leads

Module: 1987466, GM 1985 - 1992

Ignition Coil: 12558693,

Lt. Duty GM Trucks 1999 - 2007

Crank Sensor: 25526124, 25535481, 25526122

GM w/2.8 Eng. 1985 - On, w/3.8 1988 - On

IAC Valves, GM 1987 - 2007 & Chrysler 1986 - 1995

Door jamb switch, Ford 2003 - 2007

UNIT PACKAGE: 1

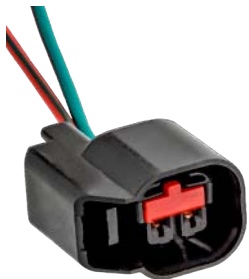

20561

(Not Supplied by O.E.M.)

**Brake Light Switch
Harness Connector**

Fits Switches YFIZ-13480-AA
& YFIZ-13480BA

Ford, Lincoln

& Mercury 2000 - On

Ford Explorer &

Mercury Mountaineer 1999 - 98

UNIT PACKAGE: 1

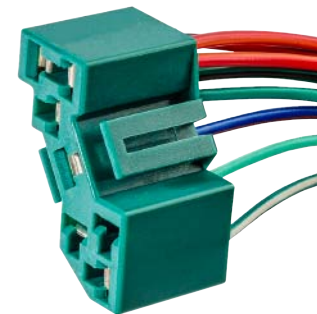

23037

(88860494, PT1939)

**Turn Signal Switch
Repair Harness Connector**

Two 18 Ga. & Six 16 Ga.

GPT 8" Leads

Switches E7FZ-13341-A,

F33Z-13341-B

Ford 1985 - 1994

UNIT PACKAGE: 1



20849

(Not Supplied by O.E.M.)

**Blower Motor Switch
Harness Connector**

Five 16 Gauge Wire Leads

Fits Switches D0HZ-19986-A, YH411

Ford Heavy Duty Trucks 1989 - 1968

UNIT PACKAGE: 1



23041

(88860521, PT1966)

**Headlight Switch
Repair Harness Connector**

Six 18 Ga. & Two 12 Ga

GPT 8" Leads

Switches: SW2105,

E7ZZ-11654-A

Lamp Switch: SW2106,

E7ZZ-11654-B

Ford Mustang 1987 - 1993

UNIT PACKAGE: 1



21490

(12102664, 88862264;
1U2Z-14S411-YA)

**Fog & Front Lights, Power
Steering & Oil Pressure Switch
Harness Connector**

GM 2005 - 1986

Ford 2004 - 1995

Jeep Eagle 1994

UNIT PACKAGE: 1



23046

(12117025, PT420, 88862272,
3U2Z-14S411-UNA,
PT2353, WPT-763)

**Crank Position Sensor,
Electric Brake Module,
Engine Cooling Fan Motor,
Engine Coolant Level Switch,
Lamp Socket Repair Harness
Connector**

Gauge: 16

Three GXL 8" Leads

GM Car & Truck 1990 - On Ford

UNIT PACKAGE: 1

WARNING: ALL ITEMS ON PAGE Reproductive Risk & Cancer www.P65Warnings.ca.gov

SWITCHES

Photos not actual size



23047
(88860566, PT2011)

**Headlight Switch
Repair Harness Connector**

One 16 Ga., One 18 Ga.
& One 20 Ga.

GPT 8" Leads

Switches: F2AZ-11654-A, F3VY-11654-A, F2AZ-11654B

Use with 17624 (91-6894)

Ford & Lincoln 1992 - 1994

UNIT PACKAGE: 1



23057

(3U2Z-14S411-MHA, WPT-439)

**Oil Pressure Switch
Repair Harness
Connector**

Gauge: 14

One TXL 8" Lead

Switches F75Z-9278-CB, F8AZ-9278-DA,

1U5Z-9278-DA,

SW-5192, SW-5696

Ford Cars & Lt. &

Med. Trucks 1997 - On

UNIT PACKAGE: 1

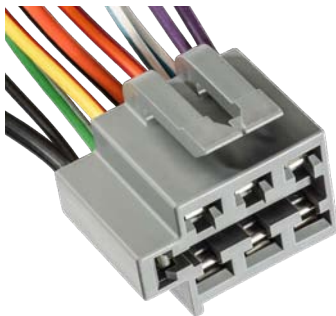

23048

(3U2Z-14S411-DTA,
WPT-238, 88860589,
PT2034)

**Blower Switch Repair
Harness Connector**

One 20 Ga., Two 18 Ga.,
Two 16 Ga., Three 14 Ga.
& Two 12 Ga.

8" Leads

Switches: YH489,
E9TZ-19986-A

Ford Bronco II, Explorer &
Ranger 1989 - 1994

UNIT PACKAGE: 1



23064

(3U2Z-14S411-JLA,
WPT292, WPT830,
5C3Z-14S411-AA)

**Vehicle Speed Sensor,
Relays, Switches, Lamps,
Pumps & Motors
Repair Harness Connector**

Gauge: 16

Two TXL 8" Leads

Sensors: 6L3Z-9E731-A,
DY-1073

Ford, Lincoln & Mercury Cars &
Lt Duty Trucks 2000- On

UNIT PACKAGE: 1



23051

(3U2Z-14S411-LJA, WPT-556,
88860576, PT2021)

**A/C Blower Switch
Repair Harness Connector**

Three 12 Ga. & One 10 Ga.

GXL 8" Leads

Switch: F0AZ-19986-C, YH510

Ford 1990 - 1994

UNIT PACKAGE: 1

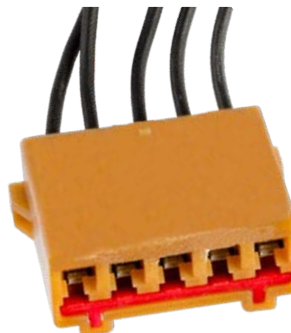

23076

(3U2Z-14S411-GAA, WPT-415,
6U2Z-14S411-TA, WPT-882)

**Stop Lamp Switch
Repair Harness Connector**

Gauge: 18

Five TXL 8" Leads

Switch: SW5219,

F87Z-13480-AA

Ford Cars &
Trucks 1998 - 2011

UNIT PACKAGE: 1



23052

(F6HZ-14A464-FUA,
3U2Z-14S411-KA, WPT-320,
88860563, PT2008)

**Ignition Switch Repair
Harness Connector**

Two 8 Ga., Four 12 Ga.,
One 14 Ga., Two 16 Ga.,
Five 18 Ga. & One 24 Ga.

All Leads 8"

Switch: SW 1379,

D7AZ-11572-A

Ford Cars &
Trucks 1970 - 1977

UNIT PACKAGE: 1

WARNING: ALL ITEMS ON PAGE Reproductive Risk & Cancer www.P65Warnings.ca.gov

FORD SOCKET ASSEMBLY & HARNESS CONNECTORS

SWITCHES

Photos not actual size



23138

Dimmer Switch Repair Harness Connector
 Gauge: 18
 Three 8" Leads
 GM 1961 - 1979
 Ford 1961 - 1979
 IHC 1967 - 1983
 Jeep 1963 - 1985

UNIT PACKAGE: 10

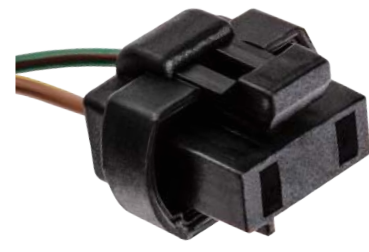

23168

(3U2Z-14S411-MGA, WPT-438, 88860488, 88860518, PT1933, PT1963)

A/C Cycling Switch Repair Harness Connector

Gauge: 16
 Two 8" PVC Wire Leads
 Switch: YH513, E35Y-19E561-A
 All Ford 1983 - On

UNIT PACKAGE: 1



23139

(88860504, LPT949)

Dimmer Switch Repair Harness Connector
 Gauge: 3
 Three 11" Leads
 Ford 1960 - 1972
 Chrysler 1959 - 1972
 American Motors 1959 - 1972

UNIT PACKAGE: 10



23169

(3U2Z-14S411-BXA 3U2Z-14S411-BFA, WPT-368, WPT-491, 88860489, PT1934)

Ignition Switch Harness Connector Kit

Contains: 1 Socket
 Four 12 Ga. & Three 10 Ga. GPT 4" Leads
 Switches: E6FZ-11572-A, SW1774B, F29Z-11572-D, SW2474, SW2472, F2TZ-11572-E
 Ford 1981 - On

UNIT PACKAGE: 1

23156

(12102747, PT374, 88862226, PT2307, 13580106, PT2625, 3U2Z-14S411-CJAA, WPT-692)

A/C Pressure Cycling & Backup Lamp Switch, Wheel Speed Sensor, EGR Valve Control & Windshield Waser Pump, Fog Lamp Repair Harness Connector

Gauge: 16
 Two GXL 8" Leads
 Switch: 25604949
 Pump: 22127653
 GM Car & Truck 1987 - On
 Ford 2000 - On
 SAAB

UNIT PACKAGE: 1

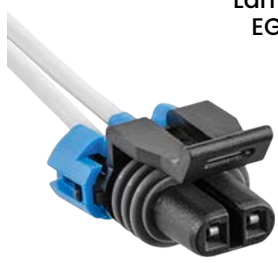

23180

(3U2Z-14S411-NUA, WPT-446, 88860532, PT1977)

Inertia Fuel Shut Off Switch Repair Harness Connector

Two 14 Ga. & One 18 Ga. SXL 8" Leads
 Switches: E8AZ-9341-A, FO2Z-A, F2AZ-A
 Ford 1990 - On

UNIT PACKAGE: 1

SWITCHES

Photos not actual size

23181

(12085485, PT107, 88862267, PT2348, 3U2Z-14S411-NZA, 3U2Z-14S411-SFA, WPT-494, WPT-564, 5019910AA)



Backup Lamp Switch, Speed Sensor, IAC Value Repair Harness Connector

Gauge: 12
Two SXL 8" Leads
Switch: 23049569, D2220A
GM Cars & Trucks 1971 - On
Ford Mustang 2001-2014

UNIT PACKAGE: 1



23203

(1U2Z-14S411-BXA, WPT-187, 88861092, PT2158)

Headlight Switch Repair Harness Connector

Gauge: 14
Eleven TXL 8" Leads
Switches: F57Z-11654-A, F87Z-11654-AA, F87Z-11654-BA, 2L5Z-11564-AA, SW5055, SW5847, SW6123
Ford Explorer, Mountaineer & Ranger 1995 - On

UNIT PACKAGE: 1

23182

(3U2Z-14S411-NKA, 3U2Z-14S411-NJA, WPT-577, WPT-475, 88860544, PT1989)



Ignition Switch Harness Connector Kit

Contains: 1 Connector, 1 Lock, Three GPT 10 Ga. Three GPT 12 Ga. One TWP 20 Ga. All Leads 4"
Switches: F2DZ-11572-A, F4DZ-11572-B
Ford, Lincoln, Mercury, Lt. Duty Trucks 1990 - On

UNIT PACKAGE: 1



23212

(F5RZ-14A411-AA, F6RZ-14A411-BA, 3U2Z-14S411-PGA, WPT-480, 88860548, PT1993)

Blower Motor Switch & Resistor Repair Harness Connector

Gauge: 12
Four GXL 8" Leads
Switches: F5RZ-18578-A, F7RZ-18578-DA
Resistors: F5RZ-18591-A, YH1722, 3M5Z-18591-BA, YH1696
Ford Contour/Mystique 1995 - 2000
Cougar 1999 - 2002
Transit Connect 2010 - On

UNIT PACKAGE: 1

23201

(1F1Z-14A411-BA, WPT-489, 88861093, PT2159, 3U2Z-14S411-RPA)



Brake Lamp Switch, Parking Lamp, Air Bag Crash Sensor Repair Harness

Gauge: 18
Two TXL 8" Leads
Switch: YF1Z-13480-BA, Sensor: 6L4Z-4B004-AA, Socket: 6R3Z-13411-BA
Ford Taurus & Sable Station Wagons 2000 - On, Explorer, Escape, Mariner, Expedition, Navigator 2001 - On
Mustang 2004 - On

UNIT PACKAGE: 1



23242

Parking Aid, A/C Switch Harness Connector

Length: 8"
Gauge: 20
3 Wires

UNIT PACKAGE: 1



23171

(E7EB-14488-NA)

Terminated Lead Male Mini Pin

Wire Gauge: 16
Length: 4"
Dwr. B5

UNIT PACKAGE 10

WARNING: ALL ITEMS ON PAGE Reproductive Risk & Cancer www.P65Warnings.ca.gov

LIGHTING

Photos not actual size



23175
(E8EB-14474-PA)

Terminated Lead Female Blade
Wire Gauge: 12
Length: 4"
Dwr. D27

UNIT PACKAGE 10



23257
(E93B-14474-AA)

Terminated Lead Female Mini Blade
Wire Gauge: 16
Length: 4"
Dwr. D43

UNIT PACKAGE 10



23178
(E8EB-14488-AFA)

Terminated Lead Female Pin Grip
Wire Gauge: 16
Length: 4"
Dwr. II

UNIT PACKAGE 10



23248
(E8EB-14474-VA)

Terminated Lead Female Box Blade
Wire Gauge: 16
Length: 4"
Dwr. D2

UNIT PACKAGE 10



23177
(E7EB-14490-EA)

Terminated Lead Female Right Angle Lamp
Wire Gauge: 18
Length: 4"
Dwr. H10

UNIT PACKAGE 10



23173
(E8EB-14474-BFA)

Terminated Lead Female Mini Blade
Wire Gauge: 16
Length: 4"
Dwr. D14

UNIT PACKAGE 10



23174
(E8EB-14474-SA)

Terminated Lead Female Blade
Wire Gauge: 16
Length: 4"
Dwr. D26

UNIT PACKAGE 10



9905

(2496279; 2973932;
3509575; 374985C1)

Instrument Panel Socket for 5/8" Hole
Bulb No. 158, 194, 194A
GM, Chrysler, AMC & International

UNIT PACKAGE: 10



11157

(4486948; 2983540, 8912698;
6299087)

Signal, Park, Stop & Tail Lights
Bulb No. 1034,
1154 & 1157
GM & AMC

UNIT PACKAGE: 1



12237

(3744750; 1200431,
25015169; C80Z-13711A)

Instrument Panel Socket for 1/2" Hole
Bulb No. 158, 194, 194A
GM, Ford & Chrysler

UNIT PACKAGE: 2



12598

(3764865, 3843245,
4124721, 4163003)

Single Contact with Ground
Bulb No. 87, 93,
1073, 1141 & 1156
Chrysler

UNIT PACKAGE: 1



12599

(3764863)

Double Contact with Ground
Bulb No. 1034,
1154 & 1157
Chrysler

UNIT PACKAGE: 1

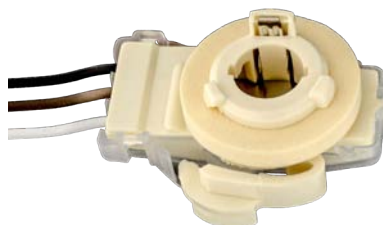

12600

(12003759;
812893)

90° Pigtail & Socket Assembly
Bulb No. 1016, 1034,
1154 & 1157
GM & AMC

UNIT PACKAGE: 1

WARNING: ALL ITEMS ON PAGE Reproductive Risk & Cancer www.P65Warnings.ca.gov

LIGHTING

Photos not actual size



13233
(3843432)

Signal & Park Lights
Bulb No. 198, 1016, 1034,
1154 & 1157
Chrysler

UNIT PACKAGE: 1



13541
(3588314)

Side Marker Assembly
Bulb No. 194, 194A
Chrysler

UNIT PACKAGE: 2



13542
(3513686, 4055028)

Side Marker Assembly
Bulb No. 194, 194A
Chrysler

UNIT PACKAGE: 2



13559

Headlight & Flasher
For all cars using 2 prong
Sealed Headlight
Bulb No. 4001

UNIT PACKAGE: 3



16174

Headlight Socket Assembly
For Low Beam 9006
Halogen Bulb
Single Indexing Groove
GM, Ford, AMC & Imports

UNIT PACKAGE: 4



16175
(12101898)

Headlight Socket Assembly
For High Beam 9005
Halogen Bulb
Two Indexing Grooves
GM, Ford, AMC & Imports

UNIT PACKAGE: 4



18921
(4636360)

Signal, Park &
Back-Up Lights
Chrysler 1993-88

UNIT PACKAGE: 1



20389

(Not Supplied by O.E.M.)

Signal, Stop, Tail &
Turn Lights
Bulb No. 1157
Chrysler including Trucks
1992 - 1989

UNIT PACKAGE: 1



21490

(12102664, 88862264,
1U2Z-14S411-YA)

Fog & Front Lights, Power
Steering & Oil Pressure Switch
Harness Connector
GM 2005 - 1986
Ford 2004 - 1995
Jeep Eagle 1994

UNIT PACKAGE: 1



22425

(3U2Z-14S411-FKAA,
3U2Z-14S411-FKAB,
5U2Z-14S411-XA, WPT-793,
WPT-859, WPT943)

Headlight
Harness Connector
Three 16 ga. TXL 8" Wire Leads
For 9008/H13 Halogen Bulb
Replaces Auvenco 20847
Ford 2004 - On

UNIT PACKAGE: 1



23073

(5013984AA)

Window & Wiper Motor,
Tail Lamp
Harness Connector Kit
Contains: 1-Connector,
Six 12 Ga. & Six 18 Ga.
TXL 8" Leads
Chrysler, Dodge
& Jeep 1997 - 2010

UNIT PACKAGE: 1



23107

(4857327AA)

Park & Turn
Signal Socket
For 3157 Bulb
Chrysler &
Dodge 2001 - On

UNIT PACKAGE: 1

WARNING: ALL ITEMS ON PAGE Reproductive Risk & Cancer www.P65Warnings.ca.gov

LIGHTING

Photos not actual size



23120
(88860530, PT1975)

**Sealed Beam
Socket Assembly**
Gauge: 16

Three GXL 8" Lead
For Lamps H4666 and H6545
GM, Firebird, Blazer 1993 - On
Ford, Probe 1993 - On
Chrysler, Daytona, Laser 1989 - 1991
UNIT PACKAGE: 1



23144
(4400448,
4400741, 4636358)

**Backup, Park &
Turn Lamps Low Profile
Socket Assembly**
Gauge: 18

Two 10" Leads
For Single Filament Wedge
Bulb 3156
Chrysler 1987 - On
UNIT PACKAGE: 6



23222
(4399900, 68063066AA,
88860571, LS171)

**Stop, Tail, Turn,
Parking & Marker
Lamp Socket**
For 3157 Bulb

Chrysler 300M, 'LH', Neon
& Mini Vans, Dakota, Durango
& Vans, Jeep Cherokee,TJ,
Wrangler 1990 - 2004
UNIT PACKAGE: 1



23223
(4676589,
88860570, LS170)

Tail Lamp Socket
For 3157 Bulb

Chrysler, Dodge
Mini Vans 1996 - 2000
Dodge Durango 1998 - 2003
Jeep Grand
Cherokee 1996 - 2004
Liberty 2002 - 2007
UNIT PACKAGE: 1



23229

**Hi-Temp Headlight
Socket Assembly**

Gauge: 14
Three 6" Leads
For Hi-Intensity
(Hi-Heat output) Bulbs
For Bulb 9004 or 9007
Connector rated at 300°C/572°F
UNIT PACKAGE: 2

⚠️ WARNING: ALL ITEMS ON PAGE Reproductive Risk & Cancer www.P65Warnings.ca.gov



23230

**Hi-Temp Headlight
Socket Assembly**

Gauge: 14
Two 6" Leads
For Hi-Intensity
(Hi-Heat output) Bulbs
Use with Bulbs 9005,
H10, H12
Connector rated at
300°C/572°F

UNIT PACKAGE: 2



23231

**Hi-Temp Headlight
Socket Assembly**

Gauge: 14
Leads Length: 6"
For Hi-Intensity
(Hi-Heat output) Bulbs
For Bulb 9006
Connector rated at
300°C/572°F

UNIT PACKAGE: 2



23277

**Map Sensor Lamp
Harness Connector**

Length: 8"
Gauge: 16
3 Wires

UNIT PACKAGE: 1



16968
(12085491)

**Fuel Injector
Solenoid Harness Connector**

Fits GM Multi-Port Fuel
Injector 1711799 on 2.8
and 3.1 liter engines
(27 models) 1986 - On
Fits Fuel Injectors on Ford,
Chrysler & Imports (Bosch)

UNIT PACKAGE: 1



23020

(12126487, PT757, 19115673,
PT2203, 19257375, PT2605,
88862215, PT2296,
3U2Z-14S411-SCA, WPT-704,
8U2Z-14S411-DA, WPT-915)

**Distributor Module
Repair Harness Connector**

Gauge: 18
Four TXL 8" Leads
Module: 1987466, GM 1985 - 1992
Ignition Coil: 12558693,
Lt. Duty GM Trucks 1999 - 2007
Crank Sensor: 25526124, 25535481, 25526122
GM w/2.8 Eng. 1985 - On, w/3.8 1988 - On
IAC Valves, GM 1987 - 2007 & Chrysler 1986 - 1995
Door jamb switch, Ford 2003 - 2007

UNIT PACKAGE: 1

CHRYSLER SOCKET ASSEMBLY & HARNESS CONNECTORS

LIGHTING AND CHARGING & STARTING

Sec. 12

Photos not actual size



23032

(12085491, PT113,
12085490, PT112,
88862303, PT2384)

**Fuel Injector
Repair Harness Connector**
Gauge: 18
Two 8" GXL Leads
Lucas & Bosch Injectors
w/External Spring Clip Retainer
Domestic & Import Vehicles

UNIT PACKAGE: 1



23162

**Fuel Injector, Crank Shaft
Harness Connector**
Length: 7.5"
Gauge: 18
2 Wires

UNIT PACKAGE: 1



23096

(88861107, PT2164)

**Fuel Injector Plug
Repair Harness Connector**
Gauge: 18
Two 8" SXL Leads
Lucas & Bosch Injectors
with External Spring Clip
Retainer Domestic & Import
Vehicles

UNIT PACKAGE: 1



23269

(3U2Z-14S411-HVA,
3U2Z-14S411- CDA,
WPT-657, WPT-304, 88861090,
PT2156, 5014002AA)

**Windshield Washer Pump,
IAC Valve, Coolant Temp,
Trans Speed Sensor
Repair Harness Connector**

Gauge: 16

Two TXL 8" Leads

Pumps: F6SZ-17664-BA, F6SU-17664-DA, WG300

IAC Valves: F65Z-9F715-EB, F75Z-9F715-AB

Ford Cars & Trucks 1995 - On, Chrysler 1997 - On

UNIT PACKAGE: 1



23135

(5183448AA)

**Fuel Injector &
ABS Sensor
Repair Harness Connector**

Gauge: 20

Two TXL 12" Leads

Chrysler, Dodge & Jeep 2001 - On

Mitsubishi 2007 - On; GM & Ford

UNIT PACKAGE: 1

CHRYSLER SOCKET ASSEMBLY & HARNESS CONNECTORS

CHARGING & STARTING



11438

**Temperature Sending Unit
Harness Connector**

GM

Voltage Regulator
Harness Connector
Chrysler

UNIT PACKAGE: 10



22776

(88953267; PT1616)

**Alternator, Door Jamb &
Brake Pressure Switch,
Washer Pump & Door Lock
Actuator Repair
Harness Connector**

Two 16 Ga. 5" Leads

Chevrolet Equinox 2007 - 2005

Hummer H2 2009 - 2003

Chrysler Cars & Light Duty Trucks 2018 - 1997

Jeep 2007 - 1998

UNIT PACKAGE: 1



11444

**Voltage Regulator
Pigtail**
GM

UNIT PACKAGE: 10



23078

(2983727,
88860471, PT1916)

**Electronic Voltage
Regulator Repair
Harness Connector**

Gauge: 16

Two 6" Leads

Chrysler 1970 - 1992

UNIT PACKAGE: 10

WARNING: ALL ITEMS ON PAGE Reproductive Risk & Cancer www.P65Warnings.ca.gov

CHRYSLER SOCKET ASSEMBLY & HARNESS CONNECTORS
HEATING & AIR CONDITIONING AND IGNITION

Photos not actual size

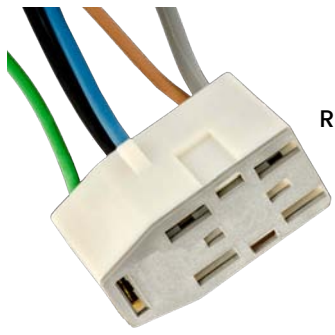

23049
(88860567, PT2012)

**Blower Motor Resistor
Repair Harness Connector**
Gauge: 12, 14 & 16
Five 8" Leads
Resistor: 4462978
Chrysler Neon &
Mini Van 1990 - 1995

UNIT PACKAGE: 1



23072
(5017124AB)

**Blower Resistor
Harness Connector Kit**
Contains: 1-Connector,
Five 16 Ga. & Five 12 Ga.
TXL 8" leads
Resistors: 5061575AA,
5061094AB, 5166541AB,
5174618AA, 5183153AA
Chrysler, Dodge &
Jeep 2001 - On

UNIT PACKAGE: 1



23095

(5102406AA,
12126486, PT756)

Blower Motor Resistor Repair Harness Connector Kit
Contains: 1-Connector, 1-Lock,
Three 12 Gauge & Three 16 Gauge
TXL 8" Leads
Resistor: 5012699AA, 68027884AB
Jeep Grand Cherokee 1999 - 2004
GM 2000 - 2006

UNIT PACKAGE: 1



23278

**Coil, Clutch, Motor,
Sensor, Solenoid, Switch
Harness Connector Kit**
Length: 8"
Gauge: 18
2 Wires

UNIT PACKAGE: 1

IGNITION



23021

**Distributor Module &
Horn Repair Harness
Connector**
Gauge: 18
Two TXL 8" Leads
Module: 1987466
Horns: 5269098,
5269099 & 5269103

GM w/2.8 (6 cyl.) Eng. 1985 - On
Chrysler 1991 - 1995

UNIT PACKAGE: 1



23198

(88862279,
PT2360, 4897087AA)

**Cam & Crank Shaft Sensors,
Ignition Coil Repair
Harness Connector**

Gauge: 18
Three TXL 8" Leads
Sensors: 4671011, 4882526,
4882851AA, 5269559,
5269559, 5269705, 4778796,
5235378, 4882850AA, 4609083,
5269703,

Coils: 4557468, 5269670, 4671025, 4557468, 4777667
Chrysler, Eagle & Mitsubishi 1995 - On

UNIT PACKAGE: 1



23278

**Coil, Clutch, Motor,
Sensor, Solenoid, Switch
Harness Connector Kit**

Length: 8"
Gauge: 18
2 Wires

UNIT PACKAGE: 1

WARNING: ALL ITEMS ON PAGE Reproductive Risk & Cancer www.P65Warnings.ca.gov

CHRYSLER SOCKET ASSEMBLY & HARNESS CONNECTORS

MISCELLANEOUS AND RELAYS

Sec. 12

Photos not actual size



22776

(88953267; PT1616)

Alternator, Door Jamb & Brake Pressure Switch, Washer Pump & Door Lock Actuator Repair Harness Connector
Two 16 Ga. 5" Leads

Chevrolet Equinox 2007 - 2005
Hummer H2 2009 - 2003
Chrysler Cars & Light Duty Trucks 2018 - 1997
Jeep 2007 - 1998

UNIT PACKAGE: 1



23021

Distributor Module & Horn Repair Harness Connector
Gauge: 18

Two TXL 8" Leads
Module: 1987466
Horns: 5269098, 5269099 & 5269103

GM w/2.8 (6 cyl.) Eng. 1985 - On
Chrysler 1991 - 1995

UNIT PACKAGE: 1



23071

(3U2Z-14S411-LKA, WPT-615, 5017112AA)

Data Link for OBDII Harness Connector Kit

Contents: 1-Connector (12110250), 2 Locks, Six 16 Ga., Six 20 Ga. & Two 22 Ga.

TXL 8" Leads

All Cars & Lt Duty Trucks
Built in the U.S. 1995 - On

UNIT PACKAGE: 1



23073

(5013984AA)

Window & Wiper Motor, Tail Lamp

Harness Connector Kit
Contains: 1-Connector, Six 12 Ga. & Six 18 Ga.
TXL 8" Leads
Chrysler, Dodge & Jeep 1997 - 2010

UNIT PACKAGE: 1



23269

(3U2Z-14S411-HVA, 3U2Z-14S411-CDA, WPT-657, WPT-304, 88861090, PT2156, 5014002AA)

Windshield Washer Pump, IAC Valve, Coolant Temp, Trans Speed Sensor Repair Harness Connector

Gauge: 16

Two TXL 8" Leads

Pumps: F6SZ-17664-BA, F6SU-17664-DA, WG300

IAC Valves: F65Z-9F715-EB, F75Z-9F715-AB

Ford Cars & Trucks 1995 - On, Chrysler 1997 - On

UNIT PACKAGE: 1



23278

Coil, Clutch, Motor, Sensor, Solenoid, Switch Harness Connector Kit

Length: 8"

Gauge: 18

2 Wires

UNIT PACKAGE: 1

RELAYS



11440

(2962510)

Air Conditioner Blower Relay Harness Connector

18 Gauge Wire
GM, AMC & Chrysler

UNIT PACKAGE: 10

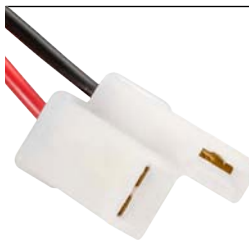

22771

(12126032; PT663)

Signal Flasher & Relay Repair Harness Connector

Two 20 ga. 6" Leads

GM, Ford, Chrysler & Import Cars & Trucks 2002 - 1956

UNIT PACKAGE: 1

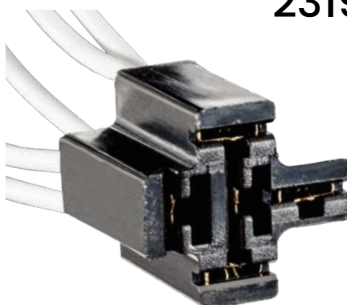

23196

(12102696, 88861106, 89057715, 88862254, PT363, PT1842, PT2163, PT2335)

Universal 5 Blade Relay Repair Harness Connector

Gauge: 16

Five GXL 8" Leads
GM 1980 - On & General Purpose

UNIT PACKAGE: 1

WARNING: ALL ITEMS ON PAGE Reproductive Risk & Cancer www.P65Warnings.ca.gov

CHRYSLER SOCKET ASSEMBLY & HARNESS CONNECTORS
RH LIGHTING AND SENSORS

Photos not actual size

RH LIGHTING



23209

(Not Available from OEM)

Halogen Headlight Socket Assembly
 Gauge: 12
 One 12" GXL Lead
 Right Angle for 1/4" Male Spade Terminals
 For H1 & H3 Halogen Bulbs
 Ford & General Purpose

UNIT PACKAGE: 1

SENSORS



23162

**Vehicle Fuel Injector,
 Crank Shaft Harness
 Connector**
 Length: 7.5"
 Gauge: 18
 2 Wires

UNIT PACKAGE: 1



23183

(8860553, PT1998)

**Oil Pressure Switch &
 Vehicle Speed Sensor
 Repair Harness Connector**
 Gauge: 20
 Two GPT 8" Leads
 Switches: 4707015,
 5233397, 56026779
 Sensors: 5227897,
 4439096, 4312032

Chrysler 1985 - 2002, Jeep 1992 - 1996

UNIT PACKAGE: 1



23198

(88862279,
 PT2360, 4897087AA)

**Cam & Crank Shaft Sensors,
 Ignition Coil Repair
 Harness Connector**
 Gauge: 18
 Three TXL 8" Leads
 Sensors: 4671011, 4882526,
 4882851AA, 5269559,
 5269559, 5269705, 4778796,
 5235378, 4882850AA, 4609083,
 5269703,

Coils: 4557468, 5269670, 4671025, 4557468, 4777667
 Chrysler, Eagle & Mitsubishi 1995 - On

UNIT PACKAGE: 1



23269

(3U2Z-14S411-HVA,
 3U2Z-14S411- CDA,
 WPT-657, WPT-304, 88861090,
 PT2156, 5014002AA)

**Windshield Washer Pump,
 IAC Valve, Coolant Temp,
 Trans Speed Sensor
 Repair Harness Connector**
 Gauge: 16

Two TXL 8" Leads
 Pumps: F6SZ-17664-BA, F6SU-17664-DA, WG300
 IAC Valves: F65Z-9F715-EB, F75Z-9F715-AB
 Ford Cars & Trucks 1995 - On, Chrysler 1997 - On

UNIT PACKAGE: 1



23271

(3U2Z-14S411-VA, WPT-206,
 3U2Z-14S411-HYA, WPT 284,
 3U2Z-14S411-HYB,
 WPT-989, 5014003AA)

**Coolant & Air Temp Sensor,
 Brake Fluid Level Sensor
 Repair Harness Connector**
 Gauge: 14

Two TXL 8" Leads
 Sensor: F5AZ-12A648-AB,
 3FIZ-12A648-A, DY719, DY1144
 Ford Cars & Trucks 1995 - On, Chrysler 1997 - On

UNIT PACKAGE: 1

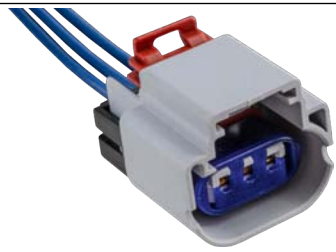

23277

**Map Sensor Lamp
 Harness Connector**
 Length: 8"
 Gauge: 16
 3 Wires

UNIT PACKAGE: 1



23278

**Coil, Clutch, Motor,
 Sensor, Solenoid, Switch
 Harness Connector Kit**
 Length: 8"
 Gauge: 18
 2 Wires

UNIT PACKAGE: 1



25161

**Coolant Temp Sensor Repair
 Harness Connector**
 2-18 ga. 8" Leads

Chrysler; Dodge Eagle 2005 - 1993;
 Hyundai 2011 - 1999; Kia 2013 - 2001;
 Mitsubishi 2012 -1993

UNIT PACKAGE: 1

WARNING: ALL ITEMS ON PAGE Reproductive Risk & Cancer www.P65Warnings.ca.gov

SWITCHES

Photos not actual size



11437

**Dimmer Switch
Harness Connector**
Ford & Chrysler

UNIT PACKAGE: 10



11438

**Temperature Sending Unit
Harness Connector**
GM
Voltage Regulator
Harness Connector
Chrysler

UNIT PACKAGE: 10



21490

(12102664,88862264; 1U2Z-14S411-YA)

**Fog & Front Lights, Power
Steering & Oil Pressure Switch
Harness Connector**
GM 2005 - 1986
Ford 2004 - 1995
Jeep Eagle 1994

UNIT PACKAGE: 1



22776

(88953267; PT1616)

**Alternator, Door Jamb &
Brake Pressure Switch,
Washer Pump & Door Lock
Actuator Repair
Harness Connector**
Two 16 Ga. 5" Leads

Chevrolet Equinox 2007 - 2005
Hummer H2 2009 - 2003
Chrysler Cars & Light Duty Trucks 2018 - 1997
Jeep 2007 - 1998

UNIT PACKAGE: 1

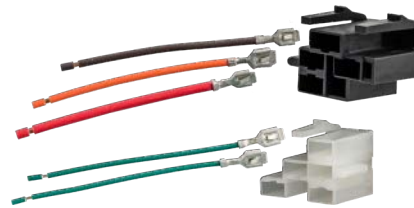

23090
88860483,
PT1928

Ignition Switch Harness Connector Kit
Contains: 2 Connectors (1-5 Position & 1-4 Position)
One 10 Ga., Two 12 Ga., Two 20 Ga.

GXL 4" Leads
Switches: GM 1990105, 1990109,
1990110, 1990115, 1990116, 7909811,
AMC/Jeep 3250575, 3250576, 8128889, 8128890
GM 1969 - On & AMC/Jeep 1978 - 1988

UNIT PACKAGE: 1

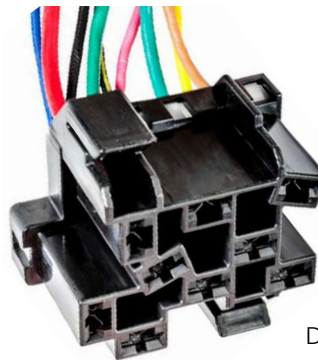

23123

(4728204,
888605850, PT1995)

**Headlight Switch
Repair Harness
Connector**
One 12 Ga., Two 14 Ga.
& Six 18 Ga.
All 8" Leads
Switch: 56007043
Dodge Dakota, "B" Van & Full
Size Pickup 1990 - On

UNIT PACKAGE: 1



23138

**Dimmer Switch
Repair Harness
Connector**
Gauge: 18
Three 8" Leads
GM 1961 - 1979
Ford 1961 - 1979
IHC 1967 - 1983
Jeep 1963 - 1985

UNIT PACKAGE: 10

WARNING: ALL ITEMS ON PAGE Reproductive Risk & Cancer www.P65Warnings.ca.gov

CHRYSLER SOCKET ASSEMBLY & HARNESS CONNECTORS SENSORS

Photos not actual size



23139
(88860504, LPT949)
**Dimmer Switch
Repair Harness Connector**
Gauge: 3
Three 11" Leads
Ford 1960 - 1972
Chrysler 1959 - 1972
American Motors 1959 - 1972
UNIT PACKAGE: 10

⚠ WARNING: Reproductive Harm & Cancer
www.P65Warnings.ca.gov



23183
(8860553, PT1998)
**Oil Pressure Switch &
Vehicle Speed Sensor
Repair Harness Connector**
Gauge: 20
Two GPT 8" Leads
Switches: 4707015,
5233397, 56026779
Sensors: 5227897,
4439096, 4312032
Chrysler 1985 - 2002, Jeep 1992 - 1996
UNIT PACKAGE: 1

⚠ WARNING: Reproductive Harm & Cancer
www.P65Warnings.ca.gov



23155
(2926502, 42096502,
88861067, PT2139)
**Neutral Safety Switch
Repair Harness Connector**
Gauge: 16
Three 8" Leads
Switches: 2932820,
3747361, 4057750
Chrysler, Jeep, AMC, IHC 1967 - 1994
UNIT PACKAGE: 1

⚠ WARNING: Reproductive Harm & Cancer
www.P65Warnings.ca.gov



23278
**Coil, Clutch, Motor,
Sensor, Solenoid, Switch
Harness Connector Kit**
Length: 8"
Gauge: 18
2 Wires
UNIT PACKAGE: 1

LIGHTING

Photos not actual size



14918
(12048369)

Headlight Socket Assembly
For High-Low 9004 & 9007 Halogen Bulb
GM, Ford & Imports

UNIT PACKAGE: 1



16174

Headlight Socket Assembly
For Low Beam 9006
Halogen Bulb
Single Indexing Groove
GM, Ford, AMC & Imports

UNIT PACKAGE: 4



16175
(12101898)

Headlight Socket Assembly
For High Beam 9005
Halogen Bulb
Two Indexing Grooves
GM, Ford, AMC & Imports

UNIT PACKAGE: 4

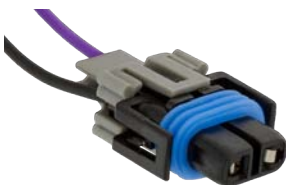

16694

(12043215, 12085498)

Cornering & Fog Light Socket for 881 & H11 Halogen Bulbs
GM

UNIT PACKAGE: 1



21210

(Not Supplied by O.E.M.)

Universal Headlight Harness Connector
For H7 Halogen Bulbs
Two 18 Gauge 6" Long Leads
Ford, Audi, BMW, Hyundai, Kia, Mazda, Mercedes, Mini Cooper, Saab & Subaru

UNIT PACKAGE: 1



21220
(88987187)

Headlight Socket Assembly
For H9 Halogen Bulb
GM, Audi, Mazda, Mini-Cooper, Porsche, Volkswagen & Volvo

UNIT PACKAGE: 1



23127

(12141388, 88986416, LS44)

Backup, License Plate, Side Marker, Parking & Turn Signal Lamp Socket Assembly

Gauge: 20

Two TXL 8" Leads

For T-3-1/4 Wedge Base Bulbs
GM Cars & Trucks 1992 - On,
Isuzu Hombre 1996 - On

UNIT PACKAGE: 1



23134

(88953146, PT1555)

Combination Lamp Back Plate Repair Harness Connector

Gauge: 20

Five TXL 8" Lead

Plate: 16532713

GM S/T Trucks 2002 - 2009

Saab 9-7 2005 - 2006

Isuzu Ascender 2003 - 2006

UNIT PACKAGE: 1



23230

Hi-Temp Headlight Socket Assembly

Gauge: 14

Two 6" Leads

For Hi-Intensity (Hi-Heat output) Bulbs
Use with Bulbs 9005, H10, H12

Connector rated at 300°C/572°F

UNIT PACKAGE: 2



23231

Hi-Temp Headlight Socket Assembly

Gauge: 14

Leads Length: 6"

For Hi-Intensity (Hi-Heat output) Bulbs
For Bulb 9006

Connector rated at 300°C/572°F

UNIT PACKAGE: 2



25291

(90075-60060)
Gray Housing

Turn Signal Lamp Socket Base
Bulb No. 7440/7440NA
Three Terminals

Toyota 4Runner 2006 - 2003, Camry 2010 - 2007,
Corolla 2013 - 2009, Highlander 2013 - 2010,
RAV4 2014 - 2012, Sequoia 2018 - 2008,
Solara 2007 - 2004, Tacoma 2016 - 2005,
Tundra 2008 - On, Venza 2017 - 2009

UNIT PACKAGE: 1

WARNING: ALL ITEMS ON PAGE Reproductive Risk & Cancer www.P65Warnings.ca.gov

IMPORT SOCKET ASSEMBLY & HARNESS CONNECTORS
AIR & FUEL, HEATING & COOLING, AND IGNITION

Photos not actual size

AIR & FUEL



16968
(12085491)

Fuel Injector Solenoid Harness Connector
 Fits GM Multi-Port Fuel Injector 1711799 on 2.8 and 3.1 liter engines (27 models) 1986 - On Fits Fuel Injectors on Ford, Chrysler & Imports (Bosch)

UNIT PACKAGE: 1



23162

Fuel Injector, Crank Shaft Harness Connector
 Length: 7.5"
 Gauge: 18
 2 Wires

UNIT PACKAGE: 1



25160

(CU2Z-14S411-UA; WPT-1277; 90980-11875 - Connector Only)

Variable Timing Solenoid, Fuel Injector, Knock Sensor Repair Harness Connector
 2-18 ga. 8" Leads

Acura 2017- 2005; Chevrolet Prism 2002 - 1998; Ford; Lincoln 2017 - 2011; Honda 2016 -2005; Isuzu 2017 - 2004 Mercedes E-320 2000; Pontiac Vibe 2010 - 2003; Scion 2015 - 2008; Suzuki 2013 - 2009; Toyota 2017 - 1998

UNIT PACKAGE: 1



23032

(12085491, PT113, 12085490, PT112, 88862303, PT2384)

Fuel Injector Repair Harness Connector
 Gauge: 18
 Two 8" GXL Leads
 Lucas & Bosch Injectors
 w/External Spring Clip Retainer
 Domestic & Import Vehicles

UNIT PACKAGE: 1



23045

(88862261, PT2342)

Fuel Injector Repair Harness Connector
 Gauge: 18
 Two 8" Leads
 w/Off Set Index
 Lucas & Bosch Injectors
 Domestic & Import Vehicles

UNIT PACKAGE: 1



23096

(88861107, PT2164)

Fuel Injector Plug Repair Harness Connector
 Gauge: 18
 Two 8" SXL Leads
 Lucas & Bosch Injectors
 w/External Spring Clip Retainer
 Domestic & Import Vehicles

UNIT PACKAGE: 1

HEATING & COOLING



23278

Coil, Clutch, Motor, Sensor, Solenoid, Switch Harness Connector Kit
 Length: 8"
 Gauge: 18
 2 Wires

UNIT PACKAGE: 1

IGNITION



22935

(19179280; PT2427)

Cam/Crank Sensor, Ignition Coil, MAP Sensor, Oil Pressure Switch & Throttle Position Sensor Repair Harness Connector
 Three 22 Ga. 8" Leads

Cadillac DeVille, Eldorado, Fleetwood & Seville 1988 - 1980, Chevrolet Express 1500-3500 & Silverado 1500, GMC Savanna 1500-3500, Silverado 1500 2014 - 2007, Pontiac Gran Prix 1984, Acura CL, MDX, RDX, RL, RSX, TL & TSX 2012 - 2001, Honda Accord, Civic, CR-V, Element, Fit, Insight, Odyssey, Pilot & Ridgeline 2011 - 2003, Scion FR-S, iA 2016 - 2013, Toyota Yaris 2018 - 2017

UNIT PACKAGE: 1

WARNING: ALL ITEMS ON PAGE Reproductive Risk & Cancer www.P65Warnings.ca.gov

CHRYSLER SOCKET ASSEMBLY & HARNESS CONNECTORS

IGNITION, MISCELLANEOUS, AND SENSORS

Sec. 12

Photos not actual size



23278

Coil, Clutch, Motor,
Sensor, Solenoid, Switch
Harness Connector Kit

Length: 8"
Gauge: 18
2 Wires

UNIT PACKAGE: 1

25210

(88986460; PT2048)

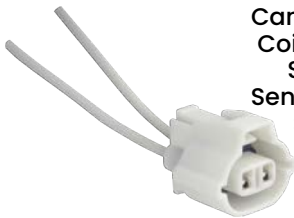

Canister Vent Solenoid, Ignition
Coil, EGR Solenoid, High Mount
Stop Light, Crank Position
Sensor & Variable Valve Timing
Solenoid Repair Harness
Connector

2-16 Ga.
8" Wire Leads

GM Camaro, Malibu 2013 - 2005; Equinox 2010 - 2005,
Nova 1988 - 1986, Metro 2001 - 1998,
Tracker 2004 - 2001, Acadia 2010 - 2007,
Yukon 2009 - 2008, Solstice, Torrent 2009 - 2006,
Vibe 2005 - 2003; Saturn Outlook, Relay 2007,
Sky 2009 - 2007; Hyundai Accent 2013 - 2005,
Elantra 2010 - 2002, Equus 2016 - 2011,
Genesis 2016 - 2009, Santa Fe, Tuscon 2015 - 2010,
Sonata 2014 - 2005, Tiburon 2013 - 2003,
Veloster 2013 - 2012; Kia Borrego 2011 - 2009,
Forte 2015 - 2010, K900 2017 - 2015,
Magentis 2009 - 2008, Optima 2015 - 2006,
Rio 2014 - 2005, Rondo 2014 - 2007,
Sorento 2015 - 2011, Soul 2013 - 2010,
Spectra 2009 - 2004, Sportage 2016 - 2004;
Lexus ES300 2003 - 1999, ES330 2006 - 2004, ES350,
GS450h, LS460, RX350 2013 - 2007, GS400 2000 - 1998,
GS430 2007 - 2001, GS460 2011 - 2008, GX460, RX450h
2013 - 2010, GX470 2007 - 2003,
HS250h 2012 - 2010, IS F 2014 - 2008,
IS250, 2013 - 2006, IS300 2005 - 2001,
LS400 2000 - 1999, LS430 2006 - 2001, LS600h, LX570
2013 - 2008, LX470 2007 - 1998,
RX300 2003 - 1999, RX330 2006 - 2004,
RX400h 2008 - 2006, SC300, SC400 2000 - 1992, SC430
2010 - 2002; Scion IQ 2015 - 2012,
tC 2010 - 2005, xA 2006 - 2004, xB 2015 - 2004; Subaru
Impreza 2005 - 1998, Legacy 2004 - 1998, Suzuki
Sidekick 1998 - 1996, Swift 2001 - 1998,
XL-7 2009 - 2006; Toyota 4Runner 2010 - 1988,
Avalon 2016 - 2000, Camry 2011 - 2002,
Corolla 1989 - 1986; Paseo 1994 - 1992,
Pickup 1995 - 1988, Solara 2008 - 2004,
T100 1998 - 1993, Tacoma 2016 - 1995, Tundra
2016 - 2005, Venza 2013 - 2009, Yaris 2014 - 2006

UNIT PACKAGE: 1

MISCELLANEOUS



23071

(3U2Z-14S411-LKA,
WPT-615, 5017112AA)

Data Link for OBDII Harness Connector Kit

Contents: 1-Connector (12110250), 2 Locks,
Six 16 Ga., Six 20 Ga. & Two 22 Ga.

TXL 8" Leads

All Cars & Lt Duty Trucks
Built in the U.S. 1995 - On

UNIT PACKAGE: 1

SENSORS

22935

(19179280; PT2427)



Cam/Crank Sensor,
Ignition Coil, MAP Sensor,
Oil Pressure Switch &
Throttle Position Sensor
Repair Harness Connector

Three 22 Ga. 8" Leads

Cadillac DeVille, Eldorado, Fleetwood &
Seville 1988 - 1980, Chevrolet Express 1500-3500 &
Silverado 1500, GMC Savanna 1500-3500,
Silverado 1500 2014 - 2007, Pontiac Gran Prix 1984,
Acura CL, MDX, RDX, RL, RSX, TL & TSX 2012 - 2001,
Honda Accord, Civic, CR-V, Element, Fit,
Insight, Odyssey, Pilot & Ridgeline 2011 - 2003,
Scion FR-S, iA 2016 - 2013,
Toyota Yaris 2018 - 2017

UNIT PACKAGE: 1

22936

(88987992; PT1795)

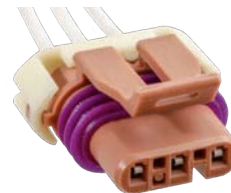

Ignition Coil & Flex Fuel Sensor
Repair
Harness Connector

Three 18 Ga. 8" Leads

Buick LeSabre, Park Avenue
& Roadmaster 2005 - 1996
Cadillac Deville, Eldorado,
Fleetwood & Seville 2005 - 1999
Chevrolet Astro, Avalanche, Blazer, C/K1500-C/K3500,
Camaro, Caprice, Corvette, Express 1500-3500, G30,
Impala, P30, S-10 Silverado 1500-3500, Sonoma,
Suburban, Tahoe 2007 - 1995
GMC C/K1500-C/K3500, G3500, Jimmy, P3500,
Safari Savana, Sierra 1500-3500,
Sonora & Yukon 2007 - 1996
Oldsmobile Auror & Bravada 2003 - 1996
Pontiac Bonneville, Firebird & Sunbird 2005 - 1994
Isuzu Hombre & NPR 2006 - 2002

UNIT PACKAGE: 1

23003

Throttle Position Harness
Connector

Length: 8"
Gauge: 16
6 Wires



UNIT PACKAGE: 1

WARNING: ALL ITEMS ON PAGE Reproductive Risk & Cancer www.P65Warnings.ca.gov

SENSORS

Photos not actual size



23004

Throttle Position Harness Connector
Length: 8"
Gauge: 16
6 Wires
UNIT PACKAGE: 1



23162

Fuel Injector, Crank Shaft Harness Connector
Length: 7.5"
Gauge: 18
2 Wires
UNIT PACKAGE: 1



23241

Crank, Park Aid Harness Connector
Length: 8"
Gauge: 18
3 Wires
UNIT PACKAGE: 1



23278

Coil, Clutch, Motor, Sensor, Solenoid, Switch Harness Connector Kit
Length: 8"
Gauge: 18
2 Wires
UNIT PACKAGE: 1



25161

Coolant Temp Sensor Repair Harness Connector
2-18 ga. 8" Leads
Chrysler; Dodge Eagle 2005 - 1993;
Hyundai 2011 - 1999; Kia 2013 - 2001;
Mitsubishi 2012 -1993
UNIT PACKAGE: 1



25162

MAP, Fuel Vapor, Pressure, Crankshaft, TPS Sensor, Ignition Coil Repair Harness Connector
2-18 ga. 8" Leads
Chevrolet Tracker 2004 - 1999; Infiniti 2019-1990;
Isuzu Rodeo 2004; Kia Sephia 1997;
Mazda 2015 - 1997; Mercury Villager 2002 - 1996;
Mitsubishi 2008 - 2004; Nissan 2020 - 1989;
Subaru 2004 - 1998; Suzuki 2012 - 1998;
Toyota 1984 - 1983

UNIT PACKAGE: 1



25210

(88986460; PT2048)

Canister Vent Solenoid, Ignition Coil, EGR Solenoid, High Mount Stop Light, Crank Position Sensor & Variable Valve Timing Solenoid Repair Harness Connector
2-16 Ga.
8" Wire Leads

GM Camaro, Malibu 2013 - 2005; Equinox 2010 - 2005, Nova 1988 - 1986, Metro 2001 - 1998, Tracker 2004 - 2001, Acadia 2010 - 2007, Yukon 2009 - 2008, Solstice, Torrent 2009 - 2006, Vibe 2005 - 2003; Saturn Outlook, Relay 2007, Sky 2009 - 2007; Hyundai Accent 2013 - 2005, Elantra 2010 - 2002, Equus 2016 - 2011, Genesis 2016 - 2009, Santa Fe, Tuscon 2015 - 2010, Sonata 2014 - 2005, Tiburon 2013 - 2003, Veloster 2013 - 2012; Kia Borrego 2011 - 2009, Forte 2015 - 2010, K900 2017 - 2015, Magentis 2009 - 2008, Optima 2015 - 2006, Rio 2014 - 2005, Rondo 2014 - 2007, Sorento 2015 - 2011, Soul 2013 - 2010, Spectra 2009 - 2004, Sportage 2016 - 2004; Lexus ES300 2003 - 1999, ES330 2006 - 2004, ES350, GS450h, LS460, RX350 2013 - 2007, GS400 2000 - 1998, GS430 2007 - 2001, GS460 2011 - 2008, GX460, RX450h 2013 - 2010, GX470 2007 - 2003, HS250h 2012 - 2010, IS F 2014 - 2008, IS250, 2013 - 2006, IS300 2005 - 2001, LS400 2000 - 1999, LS430 2006 - 2001, LS600h, LX570 2013 - 2008, LX470 2007 - 1998, RX300 2003 - 1999, RX330 2006 - 2004, RX400h 2008 - 2006, SC300, SC400 2000 - 1992, SC430 2010 - 2002; Scion IQ 2015 - 2012, tC 2010 - 2005, xA 2006 - 2004, xB 2015 - 2004; Subaru Impreza 2005 - 1998, Legacy 2004 - 1998, Suzuki Sidekick 1998 - 1996, Swift 2001 - 1998, XL-7 2009 - 2006; Toyota 4Runner 2010 - 1988, Avalon 2016 - 2000, Camry 2011 - 2002, Corolla 1989 - 1986; Paseo 1994 - 1992, Pickup 1995 - 1988, Solara 2008 - 2004, T100 1998 - 1993, Tacoma 2016 - 1995, Tundra 2016 - 2005, Venza 2013 - 2009, Yaris 2014- 2006
UNIT PACKAGE: 1

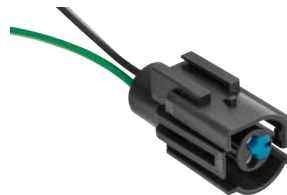

25192

(3U2Z-14S411-FZA)

Air Temp Sensor Harness
2-18 Ga.
8" Wire Leads

Ford Aerostar, Crown Victoria, Ranger 1997 - 1986, Bronco 1995 - 1986, Contour, Mystique 2000 - 1995, E-Vans 1996 - 1986, Escort 1995 - 1981, Explorer 2005 - 1991, F-Pickup & SD 2012 - 1985, Fairmont, Zephyr 1983 - 1981, Festiva 1992 - 1988, Freestar, Monterey 2007 - 2004, Granada 1982 - 1981, LTD 1991 - 1982, Mustang 2004 - 1981, Probe 1995 - 1989, Ranger 1994 - 1985, Taurus 2007 - 1986, Tempo, Topaz 1994 - 1984, Thunderbird, Cougar, Grand Marquis 1997 - 1981, Windstar 2003 - 1995, Continental 1994 - 1993, Mark VI, VII, VIII 1998 - 1980, Town Car 1994 - 1982 Capri 1994, LN7, Lynx 1987 - 1981, Marquis 1984 - 1981, Mountaineer 2001 - 1997, Sable 2005 - 1986; Tracer 1996 - 1987, Villager 1995 - 1993; Mazda B2300, B3000, B4000 1994

UNIT PACKAGE: 1

WARNING: ALL ITEMS ON PAGE Reproductive Risk & Cancer www.P65Warnings.ca.gov

SWITCHES

Photos not actual size



22935

(19179280; PT2427)

Cam/Crank Sensor,
Ignition Coil, MAP Sensor,
Oil Pressure Switch &
Throttle Position Sensor
Repair Harness Connector
Three 22 Ga. 8" Leads

Cadillac DeVille, Eldorado, Fleetwood &
Seville 1988 - 1980, Chevrolet Express 1500-3500 &
Silverado 1500, GMC Savanna 1500-3500,
Silverado 1500 2014 - 2007, Pontiac Gran Prix 1984,
Acura CL, MDX, RDX, RL, RSX, TL & TSX 2012 - 2001,
Honda Accord, Civic, CR-V, Element, Fit,
Insight, Odyssey, Pilot & Ridgeline 2011 - 2003,
Scion FR-S, iA 2016 - 2013,
Toyota Yaris 2018 - 2017

UNIT PACKAGE: 1



23278

Coil, Clutch, Motor,
Sensor, Solenoid, Switch
Harness Connector Kit
Length: 8"
Gauge: 18
2 Wires

UNIT PACKAGE: 1

UNIVERSAL SOCKET ASSEMBLY & HARNESS CONNECTORS

LIGHTING



5219

Pigtail Connector
Single Small Wire
Lead - 12" Long
For Sockets Housing
Miniature Lights

UNIT PACKAGE: 10



5221

Pigtail Connector
Double Wire
Lead - 12" Long
Aligned Ears
For Sockets Housing
Double Contact Lights

UNIT PACKAGE: 10



8755

(2978302)

License Plate, Back-Up
& Instrument Panel Lights
For 1-1/8" Hole
Bulb No. 63, 67, 81, 87, 89, 93,
209, 1003, 1073, 1129, 1133 & 1141
GM

UNIT PACKAGE: 10



8756

(2974309)

Signal, Park, Stop & Tail Lights
For 1-1/8" Hole
Bulb No. 198, 1016, 1034, 1154 & 1157
GM

UNIT PACKAGE: 10



8759

Signal, Park, Stop
& Tail Lights
For 3/4" Hole
Bulb No. 198, 1016,
1034, 1154 & 1157
GM

UNIT PACKAGE: 5

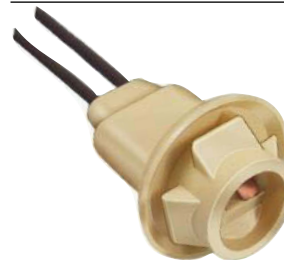

9883

(6298886,
6298892, 6298935;
D0DZ-15A434B)

Side Marker Assembly
Bulb No. 158, 194, 194A
GM & Ford

UNIT PACKAGE: 5

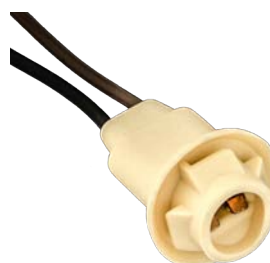

11166

(6294015,
8901283, 8918527;
D40Z-13410E,
D7AZ-13412A, D7FZ-13412A)

Side Marker &
License Plate Lights
Bulb No. 158, 194, 194A
GM & Ford

UNIT PACKAGE: 1

UNIVERSAL SOCKET ASSEMBLY & HARNESS CONNECTORS

LIGHTING

Photos not actual size



11439

Headlight & Flasher
For all cars using 3 prong sealed Headlight Bulbs 4002, 3, 5, 5040, 2, 5400, 2, 40, 421, 6006, 12 & 13
Also fits 2 & 3 Prong Flashers

UNIT PACKAGE: 10

WARNING: Reproductive Harm & Cancer
www.P65Warnings.ca.gov



11441

Instrument Panel and Marker Lights
Bulb No. 158, 194, 194A
GM & Ford

UNIT PACKAGE: 10



13554

Shielded License/Utility Light Sealed Socket Assembly with Chrome Plastic Shield
1/4" Sealed Plastic Boot

28" Lead with Male Spade Terminal
Bulb Included-Mounts in 1-1/4" Hole

UNIT PACKAGE: 1



16966

Three terminal Flasher connector pigtail designed specifically for heavy duty thermal and electronic flashers with variable and fixed loads - single and alternating flash patterns. Features three 10" long 14 gauge GXL wire leads.

UNIT PACKAGE: 2

WARNING: Reproductive Harm & Cancer
www.P65Warnings.ca.gov



22937

Not Available from O.E.M.

Headlamp Repair Harness Connector
Three 14 Ga. 8" Leads

Acura 2005 - 2003, Audi 1998 - 1994, Chevrolet 2011 - 1999, Daewoo 2002 - 1999, Eagle 1996 - 1993, Ford 2004 - 1994, Honda 2018 - 1992, Hyundai 2018 - 1999, Infiniti 2005 - 1993, Isuzu 2013 - 1996, Jeep 1974 - 1958, Kia 2018 - 1996, Land Rover 2003 - 1989, Lexus 1997 - 1994, Mazda 2014 - 1993, Mercedes 2010 - 1991, Mini 2018 - 2015, Mitsubishi 2018 - 1983, Nissan 2018 - 1993, Pontiac 2010 - 2005, Porsche 1995 - 1992, Saab 2003 - 1994, Scion 2014 - 2004, Smart 2018 - 2016, Subaru 2005 - 1992, Suzuki 2009 - 1995, Toyota 2018 - 1993, Volkswagen 2018 - 1992

UNIT PACKAGE: 1



23109

(88861108, LS229)

License Plate Socket Assembly
Wire Gauge: 18
Single Contact
Regular Base
Fits 3/4" Hole

UNIT PACKAGE: 10

WARNING: Reproductive Harm & Cancer
www.P65Warnings.ca.gov



23110

Stop, Turn & Parking Lamps Socket Assembly
Double Contact 12" Leads
Regular Base
For Indexed Bulbs 1034-1154
Fits 1-1/8" Hole Size

UNIT PACKAGE: 10

WARNING: Reproductive Harm & Cancer
www.P65Warnings.ca.gov



23111

(88861048, 88861049, LS197, LS198)

Double Contact Regular Base Socket Assembly
Lead Length: 12"
with Aligned Contacts

UNIT PACKAGE: 10

WARNING: Reproductive Harm & Cancer
www.P65Warnings.ca.gov

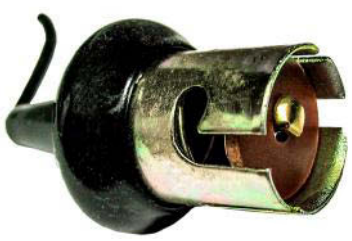

23112

(88861103, LS226)

Stop, Tail & Parking Lamps Socket Assembly
Single Contact 12" Lead
Regular Base
Fully insulated

UNIT PACKAGE: 10

WARNING: Reproductive Harm & Cancer
www.P65Warnings.ca.gov



23114

Parking Lamp and Turn Signals Socket Assembly
Double Contact 30" Leads with 1" Sealed Plastic Boot
For Bulbs 1304 and 1154
Fits 3/4" Hole Size

UNIT PACKAGE: 10

WARNING: Reproductive Harm & Cancer
www.P65Warnings.ca.gov

LIGHTING

Photos not actual size



23142

(3U2Z-14S411-BHA,
WPT-301,
12117367, PT500)

**Headlight Seal Beam
Socket Assembly**

Gauge: 18
Three 8" Leads

For Lamps 6006, 6014, 6054, 4000,
4652, 4656, 9003, H4 (HB2)

UNIT PACKAGE: 6

⚠️ WARNING: Reproductive Harm & Cancer
www.P65Warnings.ca.gov

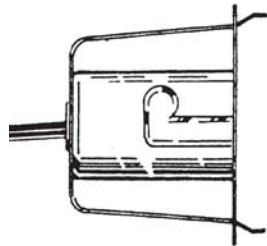

23148

(88861050, LS199)

**License Plate
Socket Assembly**

Single Contact 12" Lead
Spring Loaded
Fits 3/4" to 1-1/8" Holes

UNIT PACKAGE: 10



23209

(Not Available from OEM)

Halogen Headlight Socket Assembly

Gauge: 12
One 12" GXL Lead

Right Angle for 1/4" Male Spade Terminals
For H1 & H3 Halogen Bulbs
Ford & General Purpose

UNIT PACKAGE: 1



23220

(88861049, LS198)

**Park, Turn Signal, Tail Lamp
Socket Assembly**

Two 18 Gauge Leads
Regular Base
For Bulbs 198, 1016,
1034, 1154, 1157

UNIT PACKAGE: 5



23232

**Hi-Temp Headlight
Socket Assembly**

Gauge: 14
One 6" Lead
For Hi-Intensity
(Hi-Heat output) Bulbs
For Bulbs H1 or H3

Connector rated at 300°C/572°F

UNIT PACKAGE: 2

⚠️ WARNING: ALL ITEMS ON PAGE Reproductive Risk & Cancer www.P65Warnings.ca.gov



23233

**Hi-Temp Headlight
Socket Assembly**

Gauge: 14
Three 6" Leads
For Hi-Intensity
(Hi-Heat output) Bulbs
For H4 Bulb
Connector rated at
300°C/572°F

UNIT PACKAGE: 2



23234

**Hi-Temp Headlight
Socket Assembly**

Gauge: 14
Two 6" Leads
For Hi-Intensity
(Hi-Heat output) Bulbs
For H7 Bulb
Connector rated at
300°C/572°F

UNIT PACKAGE: 2

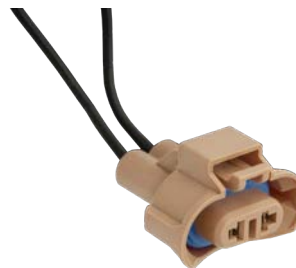

25157

**Fog Light Repair Harness
Connector**

For 880, 884, 885, 890, 892,
893, 899 Halogen Bulbs
2-18 ga. 11" Leads
Universal

UNIT PACKAGE: 1



25158

**Headlight, Fog Light &
Driving Light Repair Harness
Connector**

For H8, H11, H12, H16, 862, 881,
886, 889, 894, 896, 898
Halogen Bulbs
2-18 ga. 11" Leads
Universal

UNIT PACKAGE: 1

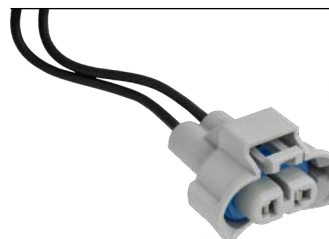

25159

**Headlight Repair Harness
Connector**

For H9 Halogen Bulb
2-18 ga. 11" Leads
Universal

UNIT PACKAGE: 1

Photos not actual size

AIR & FUEL



23045 (88862261, PT2342) Fuel Injector Repair Harness Connector Gauge: 18 Two 8" Leads w/Off Set Index Lucas & Bosch Injectors Domestic & Import Vehicles

UNIT PACKAGE: 1

MISCELLANEOUS



8768 3-Way Harness Connector 7-1/2" Leads Color Coded Wire Automotive For Truck and Marine Use where a Triple Harness is required Use with Auveco 8769

UNIT PACKAGE: 5



8769 3-Way Harness Connector 7-1/2" Leads Color Coded Wire For Automotive, Truck and Marine Use where a Triple Harness is required Use with Auveco 8768

UNIT PACKAGE: 5



8770 2 Way Harness Connector 7-1/2" Leads - 18 Gauge For Automotive, Truck and Marine Use where a double harness is required Also used on Trailers and Farm Implements

UNIT PACKAGE: 5



9900 Pigtail Connector Single Wire Lead 16 Gauge - 12" Long Snap plug for use wherever there is a junction of two or more wires; such as behind an instrument panel or in an engine compartment. Use with Auveco 9901

UNIT PACKAGE: 20



9901 Pigtail Connector Single Wire Lead 16 Gauge - 12" Long Receptacle for use wherever there is a junction of two or more wires; such as behind an instrument panel or in an engine compartment. Use with Auveco 9900

UNIT PACKAGE: 20

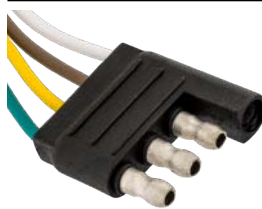

10222 4 Way Harness Connector 12" Leads - 18 Gauge For Automotive, Truck, Trailer, Marine and Farm Implement Use Use with Auveco 10223

UNIT PACKAGE: 5

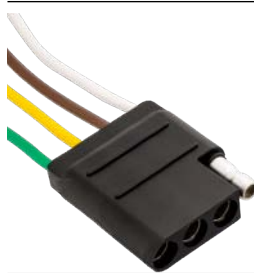

10223 4 Way Harness Connector 12" Leads - 18 Gauge For Automotive, Truck, Trailer, Marine and Farm Implement Use Use with Auveco 10222

UNIT PACKAGE: 5



10782 4 Way Harness Connector 48" Wire Leads - 18 Gauge For Automotive, Truck, Trailer, Marine and Farm Implement Use Use with Auveco 10783

UNIT PACKAGE: 2

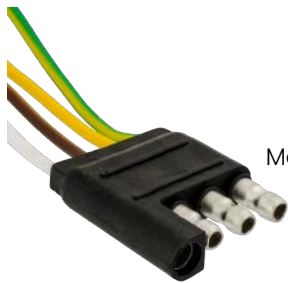

10783 4 Way Harness Connector 48" Wire Leads - 18 Gauge For Automotive, Truck, Trailer, Marine and Farm Implement Use Use with Auveco 10782

UNIT PACKAGE: 2



11434 Six Way Trailer Connector 6 Color Coded Wire Leads For Trailer Application (Male) Use with Auveco 11435

UNIT PACKAGE: 5

WARNING: ALL ITEMS ON PAGE Reproductive Risk & Cancer www.P65Warnings.ca.gov

MISCELLANEOUS
Photos not actual size



11435

Six Way Trailer Connector
6 Color Coded Wire leads
For Trailer Application
(Female)
Use with Auveco 11434

UNIT PACKAGE: 5

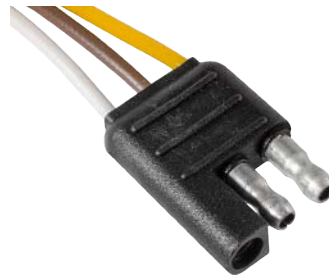

23074

**Universal Flat 3-Way
Harness Connector**
Gauge: 18
Three 12" Leads
1 Female, 2 Male

UNIT PACKAGE: 10



13634

**Complete 4-Way Trailer
Connector**
Polarized four prong
Chrome plated die cast housing
2-hole flange mounting
1-13/16" on centers
Mounting bracket available

UNIT PACKAGE: 1 Set

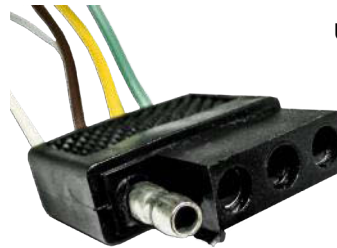

23115

**Universal 4-Way Shroud
Harness Connector**
Gauge: 18
Four 12" Leads
1 Female, 3 Male

UNIT PACKAGE: 5

13636



Complete 6-Way Trailer Connector
Assembly consists of
13639 plug and 13640 socket.
Specifically designed for
Recreational Vehicles
Die cast plug housing is
chrome plated and socket is
a one piece plastic molded unit
complete with plated spring
loaded cover and a special
moisture and dust-proof boot

UNIT PACKAGE: 1 Set



23125

**4 Cavity Shroud
Weather Pack**
Gauge: 16
Four 8" Leads
Mates with 23188

UNIT PACKAGE: 1

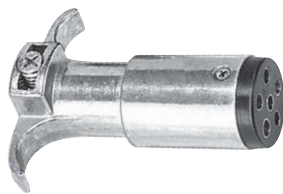

13639

**6-Way Trailer
Connector Plug**

UNIT PACKAGE: 1



23126

**6 Cavity Shroud
Weather Pack**
Gauge: 16
Six 8" Leads
Mates with 23189

UNIT PACKAGE: 1



16967
(12101906)

**Heater Blower Connector
Pigtail on GM 1985-On**
Can also be used as
an ATO/ATC Fuse Holder.
Features two 8" long 12 gauge
GXL wire leads

UNIT PACKAGE: 1



23147

(12085524, PT134,
88862250, PT2331)

**2 Cavity Shroud
Weather Pack**
Gauge: 16
Two 8" GXL Leads
Mates with 23263

UNIT PACKAGE: 1

WARNING: ALL ITEMS ON PAGE Reproductive Risk & Cancer www.P65Warnings.ca.gov

MISCELLANEOUS

Photos not actual size



23149
Moulded In-Line Glass Fuse Holder with Wire
 AMP: 20
 8" of 18 Gauge Wire

UNIT PACKAGE: 10



23150
Moulded In-Line Glass Fuse Holder with Wire
 AMP: 30
 8" of 12 Gauge Wire

UNIT PACKAGE:: 10

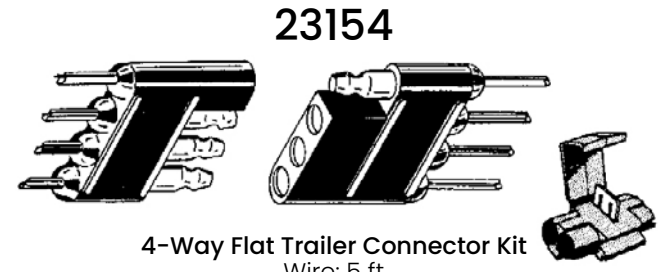

23154

4-Way Flat Trailer Connector Kit
 Wire: 5 ft

All connectors to eliminate the cutting, stripping, splicing and taping of wires

UNIT PACKAGE: 1



23187
3 Cavity Shroud Weather Pack
 Gauge: 16
 Three 8" Leads
 Mates with 23264

UNIT PACKAGE: 1



23188
4 Cavity Tower Weather Pack
 Gauge: 16
 Four 8" Leads
 Mates with 23125

UNIT PACKAGE: 1



23189
6 Cavity Tower Weather Pack
 Gauge: 16
 Six 8" Leads
 Mates with 23126

UNIT PACKAGE: 1



23263
2 Cavity Tower Weather Pack
 Gauge: 16
 Two 8" Leads
 Mates with 23147

UNIT PACKAGE: 1



23264
3 Cavity Tower Weather Pack
 Gauge: 16
 Three 8" Leads
 Mates with 23187

UNIT PACKAGE: 1

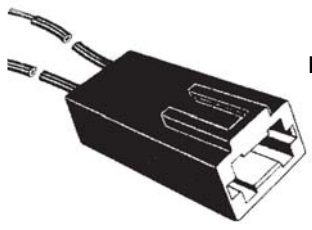

23276
In-Line Blade Type ATC/ATO Fuse Holder with Wire
 Gauge: 14
 8" Wire Loop

UNIT PACKAGE: 10



Moulded In-Line ATO/ATC Fuse Holder
Includes Fuse

Auveco Part No.	Fuse Included	Unit Pkg.
23546	ATO/ATC 10	10
23547	ATO/ATC 20	10
23548	ATO/ATC 30	5

WARNING: ALL ITEMS ON PAGE Reproductive Risk & Cancer www.P65Warnings.ca.gov

MINIATURE BULBS

Wagner Miniature Bulbs • *Photos not actual size*



Auveco Part No.	Type	Replaces Bulb No.	Unit Pkg.
16899	1	1157	10
16901	1	1157NA	10
16902	2	194	10
16904	3	1156	10
16905	4	67	10
16906	4	1895	10
16907	1	2057	10
16908	1	2057NA	10
16909	5	1893	10
16910	4	57	10
16911	4	89	10
16912	4	97	10
16913	6	211-2	10
16914	4	53	10
16915	7	3057	10
16916	7	3057NA	10
16917	7	3157	10
16918	3	1003	10
16919	5	1816	10
16920	17	1004	10
16921	2	168	10
16922	10	906	10
16923	3	1141	10
16924	1	198	10
16926	3	93	10
16927	8	PR2	10
17597	3	1156NA	10
17994	9	13050	10
17995	9	12100	10
17996	18	3156	10
17997	18	3155	10

Auveco Part No.	Type	Replaces Bulb No.	Unit Pkg.
17998	3	2396	10
17999	1	2357	10
18000	1	2357NA	10
18001	7	3157NA	10
18003	5	1889	10
18004	3	1073	10
18005	10	921	10
18006	10	916	10
18007	10	916NA	10
18008	10	912	10
18010	11	561	10
18011	6	212-2	10
18012	2	194NA	10
18013	2	193	10
18014	2	158	10
18015	12	90	10
18016	2	74	10
18017	13	24	10
18465	2	37	10
18466	3	199	10
18468	4	631	10
18469	17	1076	10
18470	4	1155	10

A - Amber (Darker)
 LL - Long Life
 NA - Natural Amber (Lighter)
 SA - Special Application

WARNING: Reproductive Harm & Cancer
www.P65Warnings.ca.gov

Continued on next page

Sec. 12

MINIATURE BULBS

Wagner Miniature Bulbs • *Photos not actual size*



Auveco Part No.	Type	Replaces Bulb No.	Unit Pkg.
18473	14	1449	10
18474	5	1815	10
18475	18	3156NA	10
18477	15	3357	10
18478	15	3357NA	10
18479	15	3157SA	10
19206	16	7440	2
19207	16	7443	2
20282	4	55	10
20283	4	63	10
20284	2	73	10
20285	2	161	10
20286	2	192	10
20291	10	904	10
20292	12	68	10
20294	10	922	10

Auveco Part No.	Type	Replaces Bulb No.	Unit Pkg.
20295	1	1638	10
20296	20	3496	10
20299	9	11005	10
20585	1	1176	10
20587	7	3457	10
20588	7	3457NA	10
20589	5	17131	10
20590	21	17171	10
20591	2	17177	10
20593	1	17916	10
20620	7	4157LL	2
20621	7	4157NALL	2
20681	1	1142	10
22887	2	7444NA	2

A - Amber (Darker)
 LL - Long Life
 NA - Natural Amber (Lighter)
 SA - Special Application

WARNING: Reproductive Harm & Cancer
www.P65Warnings.ca.gov

WAGNER HALOGEN LIGHT BULBS

Photos not actual size

Sec. 12



16896

9004/HB1 Bulb
High-Low Beam in Single Headlight Assemblies
Volts: 12-18
Watts: 25-65
Use with Auveco Socket 14918

UNIT PACKAGE: 1



18662

9007/HB5 Bulb
High-Low Beam
Volts: 12.8
Watts: 55-65
Use with Auveco Socket 14918

UNIT PACKAGE: 1



16897

9005/HB3 Bulb
High Beam in Dual Headlight Assemblies
Volts: 12.8
Watts: 65
Use with Auveco Socket 16175

UNIT PACKAGE: 1



16898

9006/HB4 Bulb
Low Beam in Dual Headlight Assemblies
Volts: 12.8
Watts: 55
Use with Auveco Socket 16174

UNIT PACKAGE: 1



20683

886 Bulb

UNIT PACKAGE: 1



20595

881 Bulb

UNIT PACKAGE: 1



18661

9003/HB2 Bulb
High-Low Beam
Volts: 12.0
Watts: 55-60
Use with Auveco Socket 5225

UNIT PACKAGE: 1



20599

893 Bulb

UNIT PACKAGE: 1



20598

891 Bulb

UNIT PACKAGE: 1



20600

1255/H3 Bulb

UNIT PACKAGE: 1

 **WARNING:** ALL ITEMS ON PAGE Reproductive Risk & Cancer www.P65Warnings.ca.gov

BULB NUMBER TO AUVECO'S WAGNER BULB NUMBER

Bulb No.	Auveco No.	Bulb No.	Auveco No.	Bulb No.	Auveco No.
H3	20600	881	20595	2057NA	16908
HB1	16896	886	20683	2357	17999
HB2	18661	891	20598	2357NA	18000
HB3	16897	893	20599	2396	17998
HB4	16898	904	20291	3057	16915
HB5	18662	906	16922	3057NA	16916
PR2	16927	912	18008	3155	17997
24	18017	916	18006	3156	17996
37	18465	916NA	18007	3156NA	18475
53	16914	921	18005	3157	16917
55	20282	922	20294	3157NA	18001
57	16910	1003	16918	3157SA	18479
63	20283	1004	16920	3357	18477
67	16905	1073	18004	3357NA	18478
68	20292	1076	18469	3457	20587
73	20284	1141	16923	3457NA	20588
74	18016	1142	20681	3496	20296
89	16911	1155	18470	4157LL	20620
90	18015	1156	16904	4157NALL	20621
93	16926	1156NA	17597	7440	19206
97	16912	1157	16899	7443	19207
158	18014	1157NA	16901	9003/HB2	18661
161	20285	1176	20585	9004/HB1	16896
168	16921	1255/H3	20600	9005/HB3	16897
192	20286	1449	18473	9006/HB4	16898
193	18013	1638	20295	9007/HB5	18662
194	16902	1815	18474	11005	20299
194NA	18012	1816	16919	12100	17995
198	16924	1889	18003	13050	17994
199	18466	1893	16909	17131	20589
211-2	16913	1895	16906	17171	20590
212-2	18011	2057	16907	17177	20591
561	18010			17916	20593
631	18468				

Halogen Bulb Industry Standard Number to Auveco Harness Connector Number

Halogen Bulb No.	Auveco Harness No.	Halogen Bulb No.	Auveco Harness No.	Halogen Bulb No.	Auveco Harness No.
880	21490	898	16694	H8	16694
881	16694	899	21490	H9	21220
884	21490	9003	11439	H10	16175
885	21490	9004	14918	H11	16694
886	16694	9005	16175	H12	16175
889	16694	9006	16174	HB1	14918
890	21490	9007	14918	HB2	11439
892	21490	9055	16175	HB3	16175
893	21490	H4	11439	HB4	16174
894	16694	H7	21210		
896	16694				

WARNING: ALL ITEMS ON PAGE Reproductive Risk & Cancer www.P65Warnings.ca.gov

HIGH PERFORMANCE IMPORTED MINIATURE BULBS

Photos not actual size



Type 1



Type 2



Type 3



Type 4



Type 5



Type 9



Type 10



Type 12



Type 13



Type 15



Type 16



Type 18



Type 22

Auveco Part No.	Type	Replaces Bulb No.	Unit Pkg.
B24	13	24	10
B53	4	53	10
B57	4	57	10
B67	4	67	10
B68	12	68	10
B89	4	89	10
B97	4	97	10
B168	2	168	10
B194	2	194	10
B194-100	2	194	100
B194A	2	194A	10
B906	10	906	10
B906A	10	906A	10
B912	10	912	10
B916	10	916	10
B916A	10	916A	10
B921	10	921	10
B921A	10	921A	10
B1141	3	1141	10
B1156	3	1156	10
B1156A	3	1156A	10
B1157	1	1157	10
B1157A	1	1157A	10
B1893	5	1893	10
B1895	4	1895	10
B2057	1	2057	10
B2057A	1	2057A	10
B2357	1	2357	10
B2357A	1	2357A	10
B2721	2	2721	10
B2722	2	2722	10
B2821	2	2821	10

Auveco Part No.	Type	Replaces Bulb No.	Unit Pkg.
B2827	2	2827	10
B3057	15	3057	10
B3057A	15	3057A	10
B3156	18	3156	10
B3156A	18	3156A	10
B3157	15	3157	10
B3157A	15	3157A	10
B3357	15	3357	10
B3457	15	3457	10
B3457A	15	3457A	10
B4114K	15	4114K	10
B4157	15	4157	10
B4157K	15	4157K	10
B5007	5	5007	10
B5008	5	5008	10
B6411	9	6411	10
B6413	9	6413	10
B6418	9	6418	10
B7225	1	7225	10
B7440	22	7440	10
B7440A	22	7440A	10
B7443	16	7443	10
B7443A	16	7443A	10
B7505	22	7505	10
B7506	3	7506	10
B7507	3	7507	10
B7528	1	7528	10

⚠ WARNING: ALL ITEMS ON PAGE Reproductive Risk & Cancer www.P65Warnings.ca.gov

HIGH PERFORMANCE IMPORTED HALOGEN BULBS

Photos not actual size



B880

880 Bulb

UNIT PACKAGE: 1



B894

894 Bulb

UNIT PACKAGE: 1



B881

881 Bulb

UNIT PACKAGE: 1



B896

896 Bulb

UNIT PACKAGE: 1



B886

886 Bulb

UNIT PACKAGE: 1



B9004

9004/HB1 Bulb
High-Low Beam in
Single Headlight Assemblies
Volts: 12-18
Watts: 25-65
Use with Auveco Socket 14918

UNIT PACKAGE: 1



B891

891 Bulb

UNIT PACKAGE: 1



B9005

9005/HB3 Bulb
High Beam in
Dual Headlight Assemblies
Volts: 12.8
Watts: 65
Use with Auveco Socket 16175

UNIT PACKAGE: 1



B893

893 Bulb

UNIT PACKAGE: 1

WARNING: ALL ITEMS ON PAGE Reproductive Risk & Cancer www.P65Warnings.ca.gov

HIGH PERFORMANCE IMPORTED HALOGEN BULBS

Photos not actual size

Sec. 12



B9006

9006/HB4 Bulb
Low Beam in
Dual Headlight Assemblies
Volts: 12.8
Watts: 55
Use with Auveco Socket 16174

UNIT PACKAGE: 1



BH7

H7 Bulb

UNIT PACKAGE: 1



B9007

9007/HB5 Bulb
High-Low Beam
Volts: 12.8
Watts: 55-65
Use with Auveco Socket 14918

UNIT PACKAGE: 1



BH9

H9 Bulb

UNIT PACKAGE: 1



BH1

H1 Bulb

UNIT PACKAGE: 1



BH10

H10/9145 Bulb

UNIT PACKAGE: 1



BH3

H3/12V 55W Bulb

UNIT PACKAGE: 1



BH11

H11 Bulb

UNIT PACKAGE: 1



B64132

H6W/ 64132 Bulb

UNIT PACKAGE: 10



BH13

H13/9008 Bulb

UNIT PACKAGE: 1

WARNING: ALL ITEMS ON PAGE Reproductive Risk & Cancer www.P65Warnings.ca.gov

Bulb Number to Auveco's High Performance Imported Bulb Number

Halogen Bulb No.	Auveco No.	Halogen Bulb No.	Auveco No.	Halogen Bulb No.	Auveco No.
24	B24	1157A	B1157A	7440A	B7440A
53	B53	1893	B1893	7443	B7443
57	B57	1895	B1895	7443A	B7443A
67	B67	2057	B2057	7505	B7505
68	B68	2057A	B2057A	7506	B7506
89	B89	2357	B2357	7507/Amber	B7507
97	B97	2357A	B2357A	7528	B7528
168	B168	2721	B2721	9004	B9004
194	B194	2722	B2722	9005	B9005
194A	B194A	2821	B2821	9006	B9006
880	B880	2827/Amber	B2827	9007	B9007
881	B881	3057	B3057	9008	BH13
885	B885	3057A	B3057A	9145	BH10
886	B886	3156	B3156	H1	BH1
891	B891	3156A	B3156A	H3	BH3
893	B893	3157	B3157	H4	B64193
894	B894	3157A	B3157A	H6W	B64132
896	B896	3357	B3357	H7	BH7
906	B906	3457	B3457	H9	BH9
906A	B906A	3457A	B3457A	H10	BH10
912	B912	4114K	B4114K	H11	BH11
916	B916	4157	B4157	H13	BH13
916A	B916A	4157K	B4157K	HB1	B9004
921	B921	5007	B5007	HB3	B9005
921A	B921A	5008	B5008	HB4	B9006
1141	B1141	6411	B6411	HB5	B9007
1156	B1156	6413	B6413		
1156A	B1156A	6418	B6418		
1157	B1157	7225	B7225		
		7440	B7440		

Bulb Number to Auveco's Premium Imported Bulb Number

Premium Imported Miniature Bulbs

Bulb No.	Auveco No.	Auveco Part No.	Type	Replaces Bulb No.	Unit Pkg.
168	20706	20706	2	168	10
3457	20728	20728	23	3457	10

NA- Natural Amber (Lighter)

SWITCHES

Photos not actual size

Push-Pull Switches



13552

Marine Switch

3 Position "Off-On-On"

First 'On' position energizes one circuit.
In second "On" position both circuits are energized.
Mounting stem 1-1/4" long. 3/8" diameter.
Brass hex back-up nut, brass washer, chrome plated
brass face nut and chrome plated knob.
15 Amps @ 12 Volts

UNIT PACKAGE: 1



12077

Push-Pull Switch

Heavy Duty

2 position "Off-On" switch with 2 Screw Terminals.

25 Amps @ 6 Volts; 15 Amps @ 12 Volts

UNIT PACKAGE: 1



Push Button Switch Heavy Duty Construction

12078

Horn Button

UNIT PACKAGE: 1

TOGGLE & ROCKER SWITCHES



13555

Brass

S.P. S.T. Toggle Switch "Off-On"

Mounting Stem 3/8" long
Diameter: 7/16" with
7/16" x 28 threads
Rating: 35 Amps @ 6 Volts
20 Amps @ 12 Volts

UNIT PACKAGE: 1



13632

D.P. D.T. Toggle Switch "On-Off-On"

Phenolic Housing
Mounting Stem 15/32" long
Diameter: 15/32"
6 Screw Terminals
Rating: 15 Amps 125 Volts AC
10 Amps 250 Volts AC
3/4 HP 120-240 Volts AC

UNIT PACKAGE: 1

 **WARNING:** ALL ITEMS ON PAGE Reproductive Risk & Cancer www.P65Warnings.ca.gov

TOGGLE & ROCKER SWITCHES

Photos not actual size



13630

S.P. S.T. Toggle Switch "Off-On"
 Phenolic Housing
 Mounting Stem 15/32" long
 Diameter: 15/32"
 2 Screw Terminals
 Bat Handle
 Rating: 15 Amps 125 Volts AC
 10 Amps 250 Volts AC
 3/4 HP 120-240 Volts AC

UNIT PACKAGE: 1



13631

S.P. D.T. Toggle Switch "On-Off-On"
 Phenolic Housing
 Mounting Stem 15/32" long
 15/32" Diameter
 3 Screw Terminals
 Bat Handle
 Rating: 15 Amps 125 Volts AC
 10 Amps 250 Volts AC
 3/4 HP 120-240 Volts AC

UNIT PACKAGE: 1



13629

S.P. S.T. Toggle Switch "Off-On"
 Two 6" Wire Leads
 Nickel plated "Off-On" indicator plate assembled
 Mounting Stem 3/8" long
 Diameter: 15/32" diameter
 Bat handle
 Rating: 15 Amps 12 Volts DC
 6 Amps 125 Volts AC

UNIT PACKAGE: 1



12076

Chrome Plated Handle
Heavy Duty Toggle Switch
 2 Position "On-Off"
 Stem Diameter: 15/32"
 Low Voltage -High Amp Application
 Rating: 35 Amps @ 6-12 Volts DC

UNIT PACKAGE: 1



13514

Black Molded Bat Handle

Heavy Duty S.P. D.T. Toggle Switch
 3 Position "On-Off-On"
 3 Blade Terminals
 Spring loaded for positive snap action
 Includes bezel nut and collar
 Fits in 1/2" diameter hole
 Rating: 16 Amps @12 Volts

UNIT PACKAGE: 1

Illuminated Toggle Switches

2 Position "Off-On"
 Handle illuminated in 'On' position
 With bezel nut and back-up collar for mounting in 1/2" hole.
 Rating: 20 Amps @ 12 Volts



Auveco Part No.	Color
13523	Red illuminated toggle
13524	Green illuminated toggle
12236	Amber illuminated toggle

UNIT PACKAGE:

WARNING: ALL ITEMS ON PAGE Reproductive Risk & Cancer www.P65Warnings.ca.gov

TOGGLE SWITCHES

Photos not actual size



Illuminated Rocker Switches

2 Position "Off-On"
Rocker illuminated in 'On' position
Snaps into 1" x 1/2"
rectangular hole
Rating: 20 Amps. @ 12 Volts

Terminal Coding:
1 -Power
2 -Accessory
3 -Ground

Auveco
Part No.

Color

12234	Red illuminated rocker
13529	Green illuminated rocker
13530	Amber illuminated rocker

UNIT PACKAGE: 1

WARNING: ALL ITEMS IN CHART Reproductive Harm & Cancer
www.P65Warnings.ca.gov



13528

Non-illuminated Rocker Switch
2 position "Off-On"
Fits 1-1/8" x 7/16" rectangular hole
Rating: 20 Amps @ 12 Volts

UNIT PACKAGE: 1

WARNING: Reproductive Harm & Cancer
www.P65Warnings.ca.gov



Illuminated Toggle Switch Mounting Panel 12233

1-1/8" x 7/16" Hole
Use with Auveco
12234, 13529, 13530 &
13531

UNIT PACKAGE: 1



Illuminated Toggle Switch Mounting Panel 12235

1/2" Hole Diameter

UNIT PACKAGE: 1



Led Indicator Lamps

- Long Lasting LED
- Mounts in 1/2" hole (12.70 MM)
- 12 Volt DC application

Installs in Auveco Mounting Panel 12235
Mates with Terminal Numbers
13660 or 12155

Auveco
Part No.

Color

22603	Red Lens
22602	Green Lens
22600	Amber Lens
22601	Blue Lens

UNIT PACKAGE: 1

WIRE LOOM CLIPS



1340

Wire Loom Clips
Clamping
Diameter: 1/4"

UNIT PACKAGE: 100



1341

Wire Loom Clips
Clamping Diameter: 3/16"

UNIT PACKAGE: 100



3758

Wire Loom Clips
Clamping Diameter: 3/8"

UNIT PACKAGE: 100



14388

(145525)

Heavy Duty
Frame Wiring Clip
Clamping Diameter: 3/16"
Fits panels from .030"-.230"

UNIT PACKAGE: 50



9864

(372741-S100)

Wire Loom Clip
General Purpose

UNIT PACKAGE: 100



Nylon Cable Clips

Auveco Part No.	Cable Size	Screw Size	Unit Pkg.
13939	3/16"	#8-10	50



Nylon Tubing & Hose Clips Adhesive Backed

Auveco Part No.	Range	Unit Pkg.
10057	5/32" to 1/4"	10
10058	5/16" to 1/2"	10



Strain-Relief Cable Connector

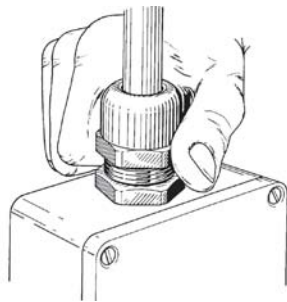

Photo not actual size

Reliable, liquid-tight, nylon strain-relief cable connector for quick and easy installation. They do not have to be disassembled before using. Simply insert a cable into the connector, tighten the cap nut and the cable is automatically fixed, centered, sealed and strain relieved.

15851

Wire Diameter: .236" - .472"
 Thread: 1/2" NPT
 Thread Length (Bottom): .512"
 Hex: .945"

UNIT PACKAGE: 5



Routing Clips

A quick, economical method of fastening wires, tubes, hoses or rods from 1/4" to 1" diameter to metal, plastic or any other surface ranging from 1/32" to 1/8" thickness. Clips are molded of durable black nylon plastic. They snap into 1/4" diameter holes and are held firmly in place by flexible "snubber tips" which compensate for variation in wall thickness.

Auveco Part No.	Tube/Hose Wire Outside Dia.	Clip Overall Height	Clip Height Above Panel	Unit Pkg.
14529	1/4"	27/32"	7/16"	25
14530	3/8"	29/32"	15/32"	25
14531	1/2"	1-1/16"	5/8"	25
14532	5/8"	1-3/16"	3/4"	25
14533	3/4"	1-5/16"	7/8"	25



22998

Black Nylon

C-Clip with Tree Mount Retainer

Overall Height: 33.5mm
 Cable Diameter: 6mm - 7.6mm
 Fits into 6.6mm Hole

- Ideal for panels with pre-drilled holes
- Easy installation by hand eliminates need for tools
- Once installed, the cable simply snaps into the clip. Cable can be removed and reinstalled without removing the clip providing multiple use options
- Excellent heat resistance and UV stability

UNIT PACKAGE: 10

Wire Loom Routing Clips

Black Nylon • Also called split flexible tubing, convoluted conduit or wiring harness

Photos not actual size



Auveco Part No.	Type	For Conduit Size		GM No.	Unit Pkg.
		I.D.	O.D.		
19440	3	1/4"	3/8"	12040984	15
19795	4	1/4"	3/8"	12015631	15
14544	1	11/32"	1/2"	8911473	25
20397*	6	10mm	13mm	12160858	15
20471	4	10mm	13mm	8905794	15
14545	1	13/32"	19/32"	8911497	25
14546	1	1/2"	11/16"	8911472	25
19851	5	1/2"	11/16"	12040983	15
14547	1	3/4"	1"	3816659 8917320	25
20665	7	19mm	24mm	12160374	15
23089	7			12176839	25

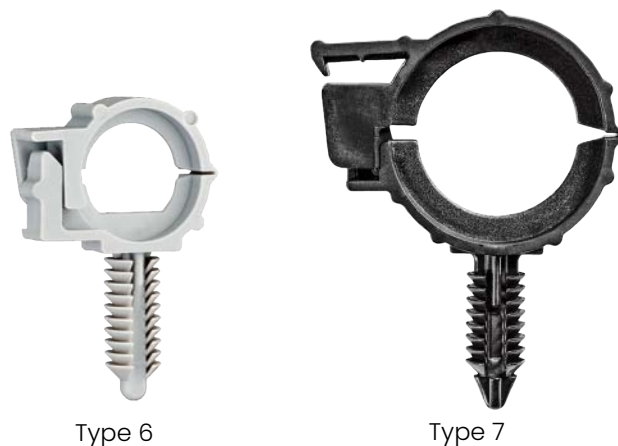

CABLE & HARNESS STRAPS



8550

Black Nylon, 2-1/4" Long

UNIT PACKAGE: 25



8273

Black Nylon, 2-3/4" Long
For 1/4" Hole in 115" Thick Metal

UNIT PACKAGE: 50



3690

Photo not actual size

Natural Nylon, 3-1/2" Long

UNIT PACKAGE: 100

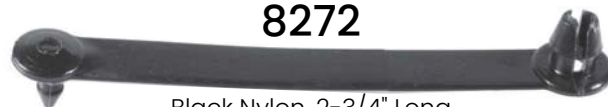

8272

Black Nylon, 2-3/4" Long
For 1/4" Hole in .093" Thick Metal

UNIT PACKAGE: 50



9115

Photo not actual size

Black Nylon, 4" Long

UNIT PACKAGE: 50



14376

(Mazda: 9928-90-753)

Black Nylon, 110mm (4-3/8") Long, Releasable,
Max. Bundle Diameter: 25mm (1"), Fits into 7mm Hole

UNIT PACKAGE: 15

CABLE & HARNESS STRAPS

Photos not actual size



20654

(Mercedes: 001-997-42-90)

Black Nylon 120mm (4-3/4") Long,
Fits into 8mm Hole

UNIT PACKAGE: 10

14298

(Honda: 90672-SA0-003; Mazda: 9928-91-053)



Black Nylon, 140mm (5-1/2") Long, Releasable, Max. Bundle Dia: 30mm (1-5/32"), Fits into 7mm Hole

UNIT PACKAGE: 25

21203



Gray Nylon, 155mm (6-1/8") Long, Max. Bundle Dia: 30mm (1-3/16"), Fits into 6.3mm (1/4") Hole

UNIT PACKAGE: 25

20655



(Mercedes: 114-997-02-90)

Black Nylon, 160mm (6-3/8") Long, Fits into 8mm (5/16") Hole

UNIT PACKAGE: 10

21355



Black Nylon, 160mm (6-3/8") Long, Max. Bundle Diameter: 36mm (1-13/32"), Fits into 7mm Hole

UNIT PACKAGE: 25

21553

(Toyota: 82711-12200)



Black Nylon, 170mm (6-3/4") Long, Max. Bundle Dia.: 40mm (1-9/16"), Fits into 13mm (1/2") Hole

UNIT PACKAGE: 25

CABLE & HARNESS STRAPS

Photos not actual size

Sec. 12

21310



Black Nylon, 174MM (6-15/16") Long, Max. Bundle Diameter: 40mm (1-9/16"), Fits into 13mm (1/2") Hole

UNIT PACKAGE: 25

20380



Black Nylon, 200mm (8") Long, Max. Bundle Diameter: 44mm (1-3/4"), Fits into 6.3mm (1/4") Hole

UNIT PACKAGE: 25

21259

(Nissan: 24225-89960)



Black Nylon, 200mm (8") Long, Max. Bundle Diameter: 55mm (2-3/16"), Fits into 8mm (5/16") Hole

UNIT PACKAGE: 25

24497



Push Mount Cable Tie

Tensile Strength: 50lb, Hole Size: 1/4" (6.3mm), Overall Length: 8.6" (219mm), Bundle Diameter: 2"(51mm) Max.

UNIT PACKAGE: 25

25006

Black Nylon

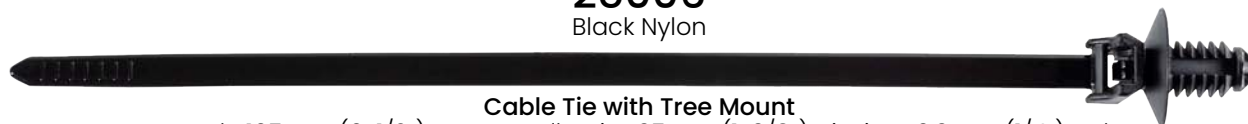

Cable Tie with Tree Mount

Length: 165mm (6-1/2"), Max. Bundle Dia.: 35mm (1-3/8"), Fits into 6.3mm (1/4") Hole

UNIT PACKAGE: 25

25005

Black Nylon



Cable Tie with Stud Mount

Length: 160mm (6"), Max. Bundle Dia.: 35mm (1-3/8"), Fits onto 6.3mm (1/4") Stud

UNIT PACKAGE: 25

22954

(Audi: 3W0-971-838)

Gray Nylon



Cable Tie

Length: 200mm (8")

Max. Bundle Diameter: 55mm (2-3/16")

Fits into 7mm (9/32") Hole

Audi Q5 2016 - 2013; R8 2012 - 2011; S5 2012 - 2008

UNIT PACKAGE: 25

CABLE & HARNESS STRAPS

Photos not actual size

Self-Clamping Natural Nylon Straps



Reusable

Auveco Part No.	Tensile Strength	Strap Length	Max Bundle Dia.	Width	Unit Pkg.
10217	18 lb.	3-7/8"	3/4"	3/32"	10
9637	50 lb.	14-7/8"	4"	3/16"	10
10218	120 lb.	14-1/2"	4"	9/32"	10

Black Nylon Cable Ties Self Clamping



Auveco Part No.	Tensile Strength	Length	Width	Unit Pkg.
15144	18 lb.	4"	3/32"	100
15196	18 lb.	4"	3/32"	1000
15145	30 lb.	5-1/2"	1/8"	100
15197	30 lb.	5-1/2"	1/8"	1000
15146	50 lb.	7"	3/16"	50
15198	50 lb.	7"	3/16"	1000
15147	50 lb.	11"	3/16"	50
15199	50 lb.	11"	3/16"	500
15753	50 lb.	14"	3/16"	25
15148	120 lb.	14"	5/16"	25
15200	120 lb.	14"	5/16"	500

Natural Nylon Cable Ties Self Clamping

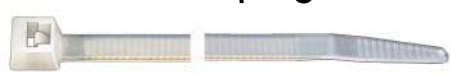

Auveco Part No.	Tensile Strength	Length	Width	Unit Pkg.
11953	18 lb.	3"	3/32"	50
11954	18 lb.	4"	3/32"	50
14836	18 lb.	4"	3/32"	100
15188	18 lb.	4"	3/32"	1000
11955	30 lb.	5"	1/8"	50
14837	30 lb.	5"	1/8"	100
15189	30 lb.	5"	1/8"	1000
11956	50 lb.	7"	5/32"	25
14838	50 lb.	7"	5/32"	50
11957	50 lb.	11"	5/32"	25
14839	50 lb.	11"	5/32"	50
15754	50 lb.	14"	5/32"	25
11958	120 lb.	14"	9/32"	10
14840	120 lb.	14"	9/32"	25
15192	120 lb.	14"	9/32"	500

Black Nylon Cable Ties Self-Clamping with Mounting Hole



Auveco Part No.	Tensile Strength	Length	Screw Hole Size	Width	Unit Pkg.
15150	50 lb.	7-1/2"	#10	3/16"	50
15202	50 lb.	7-1/2"	#10	3/16"	250
15151	120 lb.	14-3/4"	#14	5/16"	25
15203	120 lb.	14-3/4"	#14	5/16"	200

Natural Nylon Cable Ties Self-Clamping with Mounting Hole



Auveco Part No.	Tensile Strength	Length	Screw Hole Size	Width	Unit Pkg.
11961	50 lb.	7"	#10	5/32"	50
15194	50 lb.	7"	#10	5/32"	250

Cable Tie Mount with Adhesive

Uses a #6 flat head screw or 1/8" flat head rivet. Features a 4 way insertion and accepts 18, 30, and 50 pound cable ties. 1" x 1" Adhesive backing



12361

Natural Nylon

UNIT PACKAGE: 10



16001

Black Nylon

UNIT PACKAGE: 10



22999

Black Nylon

UNIT PACKAGE: 10



25004

Black Nylon

Tape-On Bundling Clip
 Head Size: 9mm x 55m
 Panel Range: 0.6mm - 5.1mm
 Fits into 6.3mm (1/4") Hole

- Designed to provide simple and easy methods for securing cable bundles, hoses or wires to the bar using tape or cable ties
 - Fits a variety of panel thicknesses
- Holding tabs prevent ties from slipping sideways

UNIT PACKAGE: 25

Steel with Rubber Seal Oil Drain Plug Gaskets



16026



24343



24344



18299



18931



18932



24345

Auveco Part No.	Nominal Size	I.D.	O.D.	Thickness	Unit Pkg.
16026	1/2" x 1"	.461"	.969"	.092"	5
24343	M12 x M24.5	11.8mm	24.5mm	1.8mm	10
24344	M13 x M25	13mm	25mm	1.9mm	10
18299	M14 x M25	14mm	24.4mm	1mm	10
18931	M16 x M24	15.8mm	24mm	2mm	10
18932	M18 x M27	18mm	27.1mm	2mm	10
24345	M21 x M35	21.4mm	35.2mm	2.1mm	10

Photos not actual size

Rubber Oil Drain Plug Gaskets



Auveco Part No.	Nominal Size	I.D.	O.D.	Thickness	Use with Drain Plug	Application	Unit Pkg.
21180	M11 x M18	10.5mm	18.7mm	2.58mm	20347	Ford 1993-On	10
21179	M11 x M19	10.5mm	19.5mm	2.78mm	21047	GM 1985-On	10
18665	M11 x M21	10.8mm	20.4mm	2.8mm	18663, 18664 20372 & 24241	GM	10
19630	M11 x M25	10.4mm	25.9mm	2.8mm	18023	GM	10
24362	M12 x M18	12mm	18mm	3mm	22143		10
24351	M12 x M19.5	12.4mm	19.5mm	3.5mm	24266		10
24348	M12 x M21	12mm	21mm	3.33mm	21354		10
20896	M13 x M19	12.5mm	19.3mm	2.8mm	19773		10
24342	M13 x M20	13mm	20.4mm	2.76mm	24228, 24229, 24230 & 24231		25
20453	M13 x M22	12.8mm	22.3mm	3.3mm	19279 & 21354	FSTZ-6734-BA	10
24361	M16 x M21	15.8mm	21mm	2.6mm			10
24350	M19 x M23	19mm	23mm	1.5mm			10
24363	M19 x M24	19mm	24mm	2.75mm	24295		10
24354	M19 x M25	19.2mm	25.2mm	3mm	22344		10
24356	M70 x M75	70mm	75mm	2.7mm			10
24355	M75 x M82	75mm	82mm	3.5mm			10

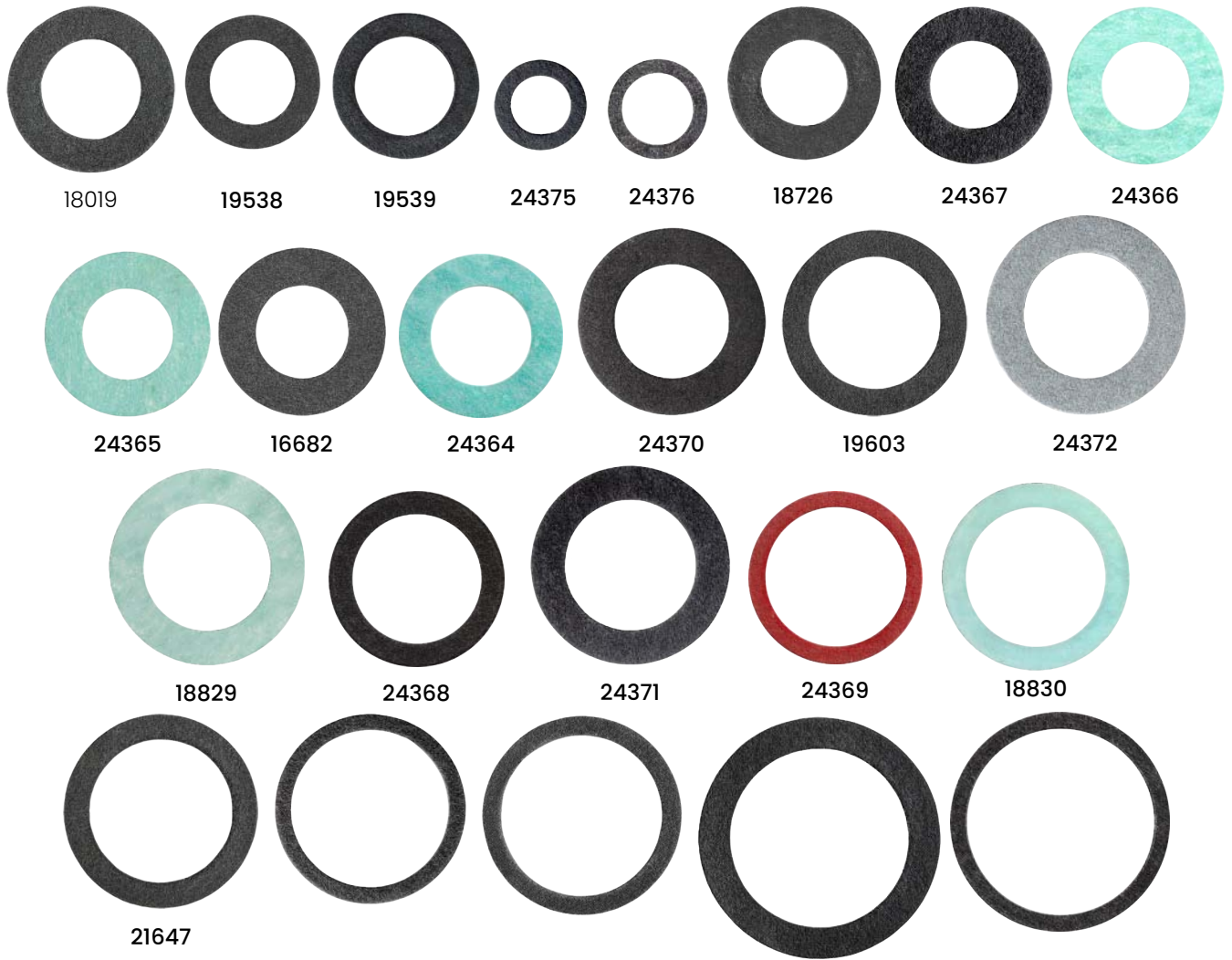

Auveco Part No.	Nominal Size	I.D.	O.D.	Thickness	Color	Unit Pkg.
18019	1/2" x 15/16"	.507"	.935"	.062"	Black	50
19538	1/2" x 3/4"	.5"	.75"	.078"	Black	50
19539	9/16" x 13/16"	.562"	.812"	.062"	Black	50
24375	M8 x M13	8mm	12.7mm	1.6mm	Black	25
24376	M10 x M14	9.75mm	14mm	1.6mm	Black	25
18726	M12 x M22	12mm	22mm	1.5mm	Black	50
24367	M12 x M22	12mm	22.1mm	2.26mm	Black	50
24366	M12 x M22	12mm	22.2mm	1.6mm	Green	25
24365	M13 x M24	12.86mm	23.78mm	1.6mm	Green	25
16682	M14 x M24	13.9mm	23.89mm	1.6mm	Black	50
24364	M14 x M24	14.1mm	23.65mm	1.68mm	Green	25
24370	M16 x M27	16mm	27mm	1.5mm	Black	50
19603	M16.4 x M27	16.7mm	26.8mm	2mm	Black	50
24372	M18 x M29	17.94mm	28.66mm	2.5mm	Black	25
18829	M18 x M29	18.3mm	28.48mm	1.6mm	Green	50
24368	M18 x M25	18.27mm	25.4mm	1.58mm	Red	25
24371	M18 x M28	18.3mm	28.44mm	1.5mm	Black	25
24369	M20 x M25	19.95mm	25.3mm	2.43mm	Red	25
18830	M20 x M28	20.3mm	27.7mm	1.6mm	Green	25
21647	M20 x M28	20.1mm	27.68mm	1.6mm	Black	25
24373	M22 x M27	22.2mm	27.15mm	1.5mm	Black	25
21648	M23 x M29	23mm	28.5mm	1.6mm	Black	25
18020	M25.5 x M35	25.5mm	34.9mm	1.6mm	Black	50
24374	M27 x M32	27mm	31.86mm	2mm	Black	25

ALUMINUM OIL DRAIN PLUG GASKETS



19590



24324



24327



24329



24326



19601



24330



19621



16956



24313



24323



24322



24314



24315



24325



16955



20462



24316



24317



21178



24319



24318



21649



24320



24328



24321

ALUMINUM OIL DRAIN PLUG GASKETS

Auveco Part No.	Nominal Size	I.D.	O.D.	Thickness	Unit Pkg.
19590	1/2" x 7/8"	.500"	.870"	.050"	25
24324	M8 x M14	8.3mm	13.75mm	.84mm	50
24327	M9 x M12	8.6mm	11.66mm	.76mm	50
24329	M10 x M16	10.15mm	15.7mm	1mm	50
24326	M12 x M18	12mm	18mm	1.5mm	50
19601	M12 x M22	12mm	22mm	1.5mm	50
24330	M12 x M15.5	12.3mm	15.5mm	1.2mm	50
19621	M14 x M20	14mm	20mm	1.4mm	50
16956	M14 x M22	14mm	22mm	2mm	50
24313	M14 x M24	14mm	24mm	1.5mm	50
24323	M14 x M22	14.3mm	21.7mm	2mm	50
24322	M14 x M24	14.4mm	23.85mm	1.4mm	50
24314	M16 x M22	15.8mm	21.88mm	1.4mm	50
24315	M16 x M27	16.4mm	26.7mm	1.5mm	50
24325	M18 x M22	18mm	21.8mm	1.3mm	50
16955	M18 x M26	18.2mm	25.8mm	1.9mm	50
20462	M18 x M24	18.3mm	23.8mm	1.5mm	25
24316	M18 x M29	18mm	28.6mm	1.6mm	50
24317	M18 x M24	18.3mm	23.8mm	2mm	50
21178	M20 x M28.5	20mm	28.5mm	1.6mm	25
24319	M20 x M28	20.3mm	27.8mm	2.2mm	25
24318	M22 x M25	22mm	25.3mm	1.5mm	25
21649	M24 x M30	24mm	30mm	1.8mm	10
24320	M24 x M34	24.3mm	33.8mm	2.5mm	10
24328	M30.5 x M38	30.5mm	38mm	2mm	10
24321	M32 x M40	32mm	39.75mm	2.4mm	10

COPPER OIL DRAIN PLUG GASKETS

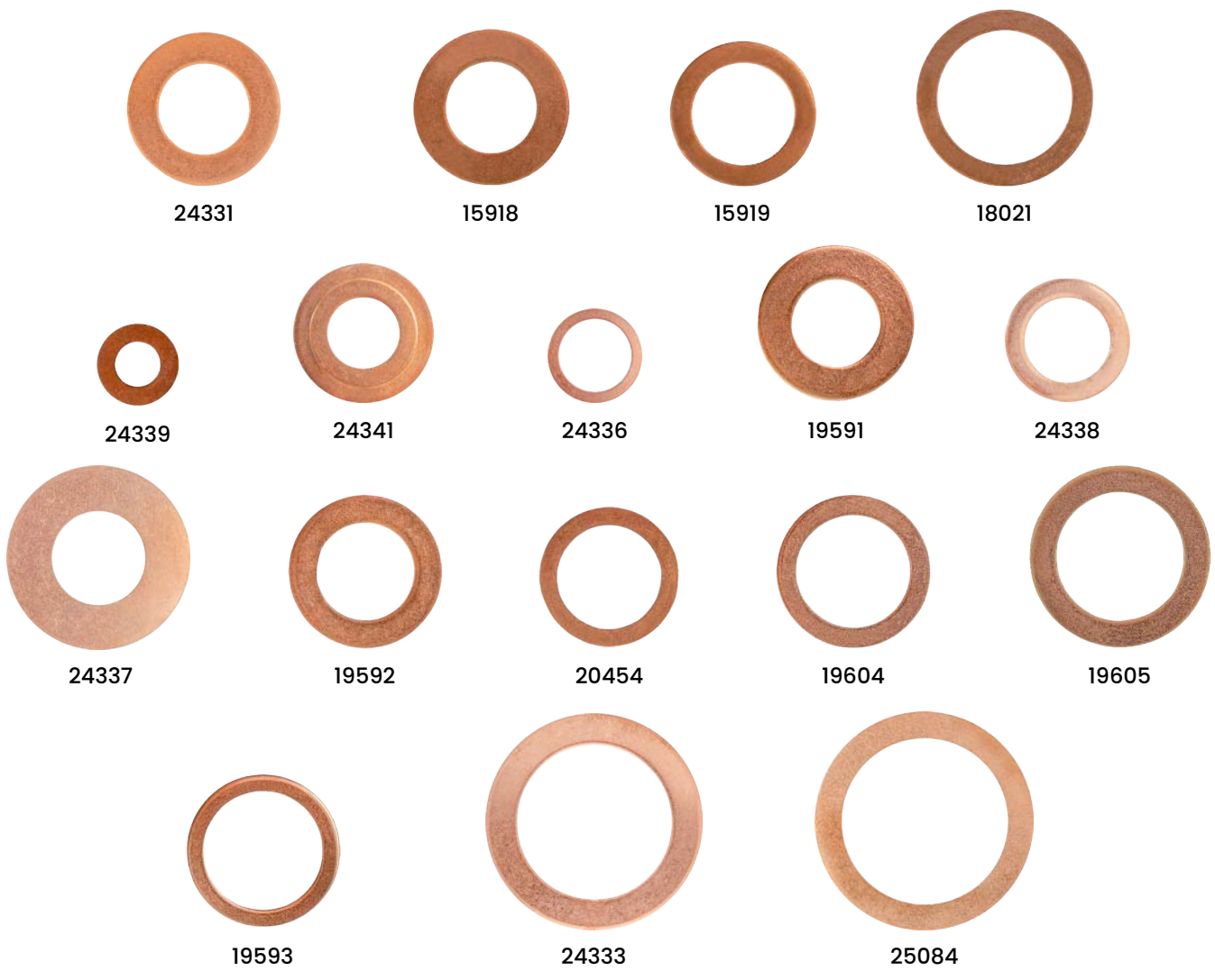

Auveco Part No.	Nominal Size	I.D.	O.D.	Thickness	Unit Pkg.
24331	1/2" x 7/8"	.5"	.88"	.05"	25
15918	1/2" x 7/8"	.5"	.875"	.062"	25
15919	9/16" x 13/16"	.553"	.81"	.092"	25
18021	3/4" x 1"	.750"	1"	.062"	25
24339	M6 x M12	6.25mm	11.80mm	.85mm	15
24341	M10 x M20	10.2mm	20.4mm	2.76mm	10
24336	M10 x M14	10.26mm	13.7mm	.9mm	25
19591	M12 x M22	12mm	22.28mm	1.5mm	15
24338	M12 x M18	12.1mm	18.1mm	1.8mm	10
24337	M13 x M27	13.4mm	26.95mm	1.4mm	10
19592	M14 x M22	13.8mm	22.16mm	1.5mm	15
20454	M14 x M20	14.4mm	19.8mm	1.3mm	15
19604	M16 x M22	15.8mm	21.9mm	1.47mm	10
19605	M18 x M26	18mm	26.11mm	1.5mm	10
19593	M20 x M26	19.8mm	26mm	1.5mm	10
24333	M22 x M32	22.2mm	31.7mm	1mm	10
25084		24mm	32mm	1mm	15

NYLON OIL DRAIN PLUG GASKETS



Auveco Part No.	Nominal Size.	I.D.	O.D.	Thickness	Unit Pkg.
8277	1/2" x 3/4"	.5"	.75"	.095"	25
24307	1/2" x 7/8"	.5"	.88"	.125"	25
16996	1/2" x 15/16"	.5"	.93"	.062"	25
8281	9/16" x 13/16"	.56"	.81"	.093"	25
8278	5/8" x 1"	.63"	1"	.092"	25
8279	3/4" x 1-1/16"	.76"	1.08"	.098"	25
16680	M12 x M22	12.3mm	22.4mm	1.6mm	50
24312	M12 x M26	12mm	26mm	1.5mm	25
24308	M12 x M21	12.1mm	21mm	2.4mm	25
16681	M14 x M24	14mm	24mm	1.6mm	50
24311	M14 x M28.5	14mm	28.5mm	1.6mm	25
24306	M14 x M25.5	14.3mm	25.5mm	3.2mm	25
16683	M16.5 x M27	16.6mm	27mm	1.6mm	50
16684	M18 x M29	18mm	29mm	1.5mm	50
24310	M18.5 x M25	18.5mm	25.4mm	1.6mm	25
16685	M20 x M26	20mm	26mm	1.6mm	50
24309	M20 x M32	20.4mm	31.8mm	1.5mm	25

CRUSHABLE OIL DRAIN PLUG GASKETS



19545



24300



24303



24297



24304



17261



21258



24305



19007



17262



24296



22223



24299



21677



17263



17264



21116



24301



17265



19139



24298



24377



24302

Auveco Part No.	Nominal Size	I.D.	O.D.	Thickness	Material	Unit Pkg.
19545	1/2" x 3/4"	.512"	.736"	.089"	Copper	10
24300	M6 x M10	6.3mm	9.7mm	1.7mm	Copper	10
24303	M8 x M11	8.2mm	11.3mm	1.5mm	Copper	10
24297	M10 x M16	10.4mm	15.8mm	1.85mm	Copper	10
24304	M12 x M17	11.9mm	17mm	2.25mm	Steel	10
17261	M12 x M18	12.4mm	17.5mm	2.25mm	Copper	10
21258	M12 x M18	11.1mm	17.4mm	3.33mm	Copper	10
24305	M13 x M17	12.8mm	17.15mm	2.56mm	Steel	10
19007	M14 x M19	14.3mm	19.44mm	2.28mm	Steel	10
17262	M14 x M20	14mm	20mm	2.4mm	Copper	10
24296	M14 x M20	14mm	20mm	2.15mm	Copper	10
24299	M16.4 x M22	15.4mm	22mm	3.2mm	Copper	10
21677	M16 x M21	16mm	21.2mm	2.3mm	Steel	10
17263	M16 x M22	16.35mm	21.72mm	2mm	Copper	10
17264	M18 x M24	18mm	23.75mm	2mm	Copper	10
21116	M18 x M24	18.2mm	24.2mm	2.5mm	Steel	10
24301	M18 x M25	18mm	25mm	2.3mm	Steel	10
17265	M20 x M26	20.4mm	25.75mm	2.15mm	Copper	10
19139	M20 x M26	20mm	26mm	2.7mm	Steel	15
24298	M22 x M27	22.2mm	26.70mm	2.16mm	Copper	10
24377	M24 x M31	24.5mm	31.5mm	3.46	Aluminum	10
24302	M26.5 x M31	26.5mm	31.2mm	2.2mm	Copper	10



24347

Graphite & Aluminum

Inner Diameter: 12.18mm
Outer Diameter: 20.88mm
Thickness: 1.46mm

UNIT PACKAGE: 10



18849

Graphite Coated Steel

Inner Diameter: 12mm
Outer Diameter: 21mm
Thickness: 1.8mm

UNIT PACKAGE: 5



22134

(Toyota: 90430-12031,
90430-12018, 90430-12027
& 90430-C0005)
Fibre & Aluminum

**Oil & Transmission
Drain Plug Gasket**

Inner Diameter: 12mm
Outer Diameter: 21mm
Thickness: 1.75mm

Toyota 4Runner, Avalon, Camry, Celica, Corolla, Echo,
FJ Cruiser, Highlander, Land Cruiser, Matrix, MR2, Paseo,
Previa, Prius, RAV4, Sequoia, Sienna, Solara, Supra, T100,
Tacoma, Tercel, Tundra, Venza & Yaris
1991 - On

UNIT PACKAGE: 5



24353

Rubber Coated Aluminum

Inner Diameter: 12.1mm
Outer Diameter: 21.4mm
Thickness: 1.64mm

UNIT PACKAGE: 10

View our Marli by Auveco Oil Drain Plug and Gasket Kits



MA100

OEM Specific Oil Drain
Plugs & Gaskets



MA101

Oil Drain Plugs &
Gaskets



MA102

Oil Drain Gaskets

Go to page 383 in the green pages to view all assortment contents.

OIL & TRANSMISSION DRAIN PLUGS WITH GASKETS



24228
Yellow Zinc

Thread: 1/2"-20
Hex: 11/16"
Length Under Head: 3/8"
Washer Head O.D.: 15/16"

UNIT PACKAGE: 2



19130
(3921988)
Phosphate

Thread: 1/2"-20
Hex: 9/16"
Length Under Head: 13/16"
Washer Head O.D.: 7/8"

Buick: 4, 6 & 8 Cylinder All [Exc. 2.5(151) 3.0, 4.3, 4.9 (301 Eng.)] 59-On; Cadillac: 6 & 8 Cylinder All (Exc. 4.1 Eng) 66-On Chevrolet (Inc. GMC Light Truck): 4, 6 & 8 Cylinder All [Exc. 1.8 (diesel), 2.5 (151), 4.3 (diesel) Eng.] 28-On Oldsmobile: 4, 6 & 8 Cylinder All [Exc. 1.8 (diesel), 2.5 (151), 3.0, 4.3, (diesel), 4.3S, 4.9T (301)Eng.] 61-On; Pontiac: 4, 6 & 8 Cylinder All [Exc. 1.8 (diesel), 2.5 (151), 4.3 (diesel), 4.3S, 4.9T (301)Eng.] 60-On

UNIT PACKAGE: 15



24229
Zinc

Thread: 1/2"-20 O.S.
Hex: 11/16"
Length Under Head: 3/8"
Washer Head O.D.: 15/16"

UNIT PACKAGE: 2



18373
(6034376)
Plain with Rubber
Washer Face Gasket

Thread: 1/2"-20
Hex: 5/8"
Length Under Head: 13/16"
Rubber Gasket O.D.: 1-3/32"
Chrysler

UNIT PACKAGE: 2

24233
Zinc



Thread: 1/2"-20
Hex: 3/4"
Length Under Head: 1/2"

UNIT PACKAGE: 5



14196
Zinc

Thread: 1/2"-20
Hex: 7/8"
Length Under Head: 1/2"

AMC 6 & 8 Cylinder All 64-On; Buick 4, 6 & 8 Cylinder All [Exc. 2.5 (151), 3.0, 4.3, 4.9 (301 Eng.)] 59-On; Cadillac 6 & 8 Cylinder All (Exc. 4.1 Eng) 66-On; Chevrolet (Includes Light Truck): 4, 6 & 8 Cylinder All [Exc. 1.8 (diesel), 2.5 (151), 4.3 (diesel) Eng.] 28-On; Chrysler Corp. 6 & 8 Cylinder All 62-On; Ford Motor Co. 4, 6 & 8 Cylinder All (Exc. 98, 122, 140, 171 Eng) 57-On; GMC (Light Truck): 6 & 8 Cylinder All 39-On; Oldsmobile 4, 6 & 8 Cylinder All [Exc. 2.5 (151), 3.0, 4.3, (diesel), 4.3S, 4.9T (301)] 61-On; Pontiac 4, 6, & 8 Cylinder All [Exc. 1.8 (diesel), 2.5 (151), 4.3 (diesel), 4.3S, 4.9T (301)] 60-On

UNIT PACKAGE: 10



24239
Zinc

Thread: 1/2"-20
Hex: 7/8"
Length Under Head: 13/16"
AMC, Chrysler & Cadillac

UNIT PACKAGE: 2

OIL & TRANSMISSION DRAIN PLUGS WITH GASKETS



24268
Yellow Zinc/Rubber
Universal Winged Drain Plug

Thread: 1/2"-3/4"
Hand Tighten
Length Under Head: 2"-1/8"
Washer Head O.D.: 1"-3/8"

UNIT PACKAGE: 1



24292
Black Plastic

Installation tool for
Drain Plug 22143

UNIT PACKAGE: 1

24240
Zinc



Thread: 5/8"-18
Hex: 1/2"
Length Under Head: 1/2"
Washer Head O.D.: 7/8"
AMC, Chrysler

UNIT PACKAGE: 2



24295
(GM: 55498782)
Black Nylon

Cam Locking
Internal Square Hex
Length Under Head: 25.5mm
Washer Head O.D.: 28mm
Install with tool 24294

Cadillac CT6 2.0L L4 - Gas, 3.0L V6 - Gas, 3.6L V6 - Gas
2019 Cadillac XT4 2.0L L4 - Gas, 2.0L L4 - Gas 2019 - On
Cadillac XT5 2.0L L4 - Gas 2019

UNIT PACKAGE: 1



24294
Black Plastic

Installation tool for
Drain Plug 24295

UNIT PACKAGE: 1



18022
(948187-0)
Zinc

Thread: 3/4"-16
Hex: 1"
Length Under Head: 1/2"
Volvo 4 Cylinder

UNIT PACKAGE: 2



22143
(VW: 06L-103-801)
Black Plastic

Oil Drain Plug w/Rubber O-Ring
Screw Driver Slot
Head Diameter: 23mm
Overall Height: 20mm
Install with tool 24292
Audi A3 & S3 and Volkswagen
Golf & GTI 2015 - On

UNIT PACKAGE: 1



24266
(Mercedes: 002-990- 20-17)
Black Plastic

Cam Locking
Screw Driver Slot

Length Under Head: 35mm
Washer Head O.D.: 28mm
Install with tool 24293
Mercedes

UNIT PACKAGE: 1

OIL & TRANSMISSION DRAIN PLUGS WITH GASKETS



24293
Black Plastic

Installation tool for
Drain Plug 24266

UNIT PACKAGE: 1



24267
(Ford: KX6Z-6730-B)
Yellow Plastic

Cam Locking Hand Drive
Length Under Head: 40mm
Ford

UNIT PACKAGE: 1



19318
(Jeep: 8350404; Lexus: 90341-10006,
90341-10012)
Zinc & Yellow

Thread: M10-1.5
Hex: 14mm
Length Under Head: 9mm
Jeep Cherokee, Comanche &
XJ 1991-On; Lexus GS300,
LS400 & SC400 1991-On

UNIT PACKAGE: 2



20807
(F81Z-6730-AA)
Plain with Rubber
Washer Face Gasket

Thread: M10-1.5
Hex: 13mm
Length Under Head: 15mm
Rubber Gasket O.D.: 28mm
Ford E150-450, F150-450 Excursion &
Expedition 1980 - On

UNIT PACKAGE: 1



15527
Zinc
Thread M12-1.25
Hex: 14mm
Length Under Head: 11mm
Washer Head O.D.: 20mm
Nissan: Sentra, Stanza & Pulsar
with FWD 1982-On

UNIT PACKAGE: 5



21293
Zinc & Yellow
Thread: M12-1.25
Hex: 14mm
Length Under Head: 12mm
Washer Head O.D.: 23mm
Nissan Sentra & 350Z and
Infiniti 1992 - On

UNIT PACKAGE: 2

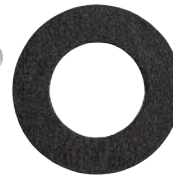

19588
Zinc
Thread: M12-1.25
Hex: 14mm
Length Under Head: 17mm
Washer Head O.D.: 20mm
Nissan

UNIT PACKAGE: 5



19589
Zinc
Thread M12-1.5
Hex: 13mm
Length Under Head: 12mm
Washer Head O.D.: 17mm
BMW & Mercedes

UNIT PACKAGE: 5



24248
(BMW: 11-131-250-089)
Yellow Zinc
Thread: M12-1.5
Hex: 17.5mm
Length Under Head: 18mm
BMW

UNIT PACKAGE: 2

OIL & TRANSMISSION DRAIN PLUGS WITH GASKETS

18023

(21006725)

Black Zinc

With Rubber Gasket



Thread: M12-1.75
Hex: 14mm
Length Under Head: 19mm
Rubber Gasket O.D.: 31mm
GM: Saturn

UNIT PACKAGE: 2

21047

(GM: 3536964, 3538469,

11519408,11562588,

24100042

Isuzu: 8-11519-408-0)

Zinc

with Rubber Gasket



Thread: M12-1.75
Hex: 15mm
Length Under Head: 25mm
Washer Head O.D.: 26mm
GM: 2.2 (4), 3.1 (M), 3.8 (K), 3.8 (I), 2.3, 4.9
& 6.0L Eng. 1985 - On

UNIT PACKAGE: 2

22360

(GM: 55577568)

Zinc



Oil Drain Plug with Rubber Gasket

Thread: M12-1.75

Hex: 15mm with T45 Internal Drive

Length Under Head: 17mm

Washer Head O.D.: 26.5mm

Chevrolet Sonic 2013 - On

UNIT PACKAGE: 1

24241

(GMC: 3536964)

Phosphate



Thread: M12-1.75
Hex: 15mm
Length Under Head: 25mm
Washer Head O.D.: 26.38mm
GMC

UNIT PACKAGE: 2

18374

(F5AZ-6730)

Plain With Rubber

Washer Face Gasket



Thread: M12-1.75

Hex: 15mm

Length Under Head: 21mm

Rubber Gasket O.D.: 28mm

Ford: 2.5, 3.0 & 4.6 Eng. with Modular
& Aluminum Pans

UNIT PACKAGE: 2

24242

(GM: 3538469)

Phosphate



Thread: M12-1.75
Hex: 15mm
Length Under Head: 25mm
Washer Head O.D.: 30.46mm
Cadillac

UNIT PACKAGE: 2

20347

(YS4Z-6730AA)

Plain with
Rubber Gasket



Thread: M12-1.75

Hex: 13mm

Length Under Head: 25mm

Washer Head O.D.: 26mm

Ford 1999 - 93

UNIT PACKAGE: 2

**OIL & TRANSMISSION DRAIN PLUGS
WITH GASKETS**



14677
Zinc

Thread: M12-1.75
Hex: 15mm
Length Under Head: 26mm
Washer Head O.D.: 22mm

Fits the following M12-1.75 applications:
Buick: 4 Cylinder 151 (2.5) Eng. 80-On 6 Cylinder 3.0, 4.3 (Diesel) Eng. 82-On 8 Cylinder 4.3, 4.9 Eng. 81-77
Cadillac: 8 Cylinder 4.1 Eng. 82-On
Chevrolet: 4 Cylinder 151 (2.5) Eng. 78-On 6 Cylinder 4.3 (Diesel) Eng. 82-On
Oldsmobile: 4 Cylinder 151 (2.5) Eng. 78-On 6 Cylinder 3.0, 4.3 (Diesel) Eng. 82-On 8 Cylinder 4.3S, 4.9T (301) Eng. 80-79
Pontiac: 4 Cylinder 151 (2.5) Eng. 77-On 6 Cylinder 4.3 (Diesel) Eng. 82-On 8 Cylinder 4.3S, 4.9T (301) Eng. 81-77

UNIT PACKAGE: 5



24237
Zinc

Thread: M14-1.25
Hex: 19mm
Length Under Head: 12mm

UNIT PACKAGE: 5



18024
Zinc

Thread: M14-1.25
Hex: 13mm
Length Under Head: 16mm
Washer Head O.D.: 23mm
Jeep

UNIT PACKAGE: 5



24271

(Ford: XW4Z-6730-BA)
Plain with Rubber
Washer Face Gasket

Thread: M12-1.75
Hex: 15mm
Length Under Head: 28mm
Washer Head O.D.: 27mm
Ford

UNIT PACKAGE: 2



21353
(90009-PHI-000)
Zinc & Yellow

Thread: M14-1.5
Hex: 17mm
Length Under Head: 10mm
Washer Head O.D.: 24mm
Acura & Honda

UNIT PACKAGE: 5



24265
(GM: 24100042)
Zinc

Thread: M12-1.75
Hex: 13mm
Length Under Head: 30mm
Washer Head O.D.: 26mm
GM

UNIT PACKAGE: 2



24230
Yellow Zinc

Thread: M14-1.5
Hex: 17mm
Length Under Head: 10mm
Washer Head O.D.: 24mm

UNIT PACKAGE: 2

OIL & TRANSMISSION DRAIN PLUGS WITH GASKETS



16308
Zinc

Thread: M14-1.5
Hex: 16mm
Length Under Head: 11mm
Washer Head O.D.: 25mm

Fits the following M14-1.5 applications:
Chrysler Imports 83-On; Honda 83-On; Isuzu 87-On
Mazda: 72-On; Spectrum 88-On; Sprint 88-On
VW-Audi 74-On

UNIT PACKAGE: 5



21650
(55568037)
Zinc

Thread: M14-1.5
Hex: 10mm
Length Under Head: 16mm
Washer Head O.D.: 27mm
Chevrolet Cruze & Volt 2010 - On

UNIT PACKAGE: 2



24263
(VW: N91167901)
Zinc

Thread: M14-1.5
Hex: Torx T-50
Length Under Head: 12mm
Washer Head O.D.: 18.85mm
Volkswagen

UNIT PACKAGE: 5

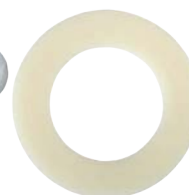

18025
(E9DZ-6730-B)
Zinc

Thread: M14-1.5
Hex: 13mm
Length Under Head: 16mm
Washer Head O.D.: 23mm
Ford Escort

UNIT PACKAGE: 5



21352
(N90288901)
Black Zinc

Thread: M14-1.5
Hex: 19mm
Length Under Head: 14mm
Volkswagen

UNIT PACKAGE: 2



24259
Yellow Zinc

Thread: M14-1.5
Hex: 19mm
Length Under Head: 16mm
Washer Head O.D.: 25mm

UNIT PACKAGE: 2



20426
(90009-PY3-000)
Zinc & Yellow
with Aluminum Gasket

Thread: M14-1.5
Hex: 17mm

Length Under Head: 15mm
Washer Head O.D.: 24mm

Fits the following M14-1.5 applications:
Acura & Honda 2000 - On

UNIT PACKAGE: 5



22196
(Mazda: FS50-21-249 -
Drain Plug,
9956-41-400 - Gasket)
Zinc

Thread: M14-1.5
Drive: 8mm Allen
Length Under Head: 16mm
Head Diameter: 22mm
Mazda: 3, 6 & CX-5 2012 - On; RX-8 2011 - 09

UNIT PACKAGE: 2

OIL & TRANSMISSION DRAIN PLUGS WITH GASKETS



21135
(21512-23001)
Dacromet

Thread: M14-1.5
Hex: 17mm
Length Under Head: 17mm
Washer Head O.D.: 22.5mm
Hyundai & Kia 1995 - On

UNIT PACKAGE: 2



22205
(Honda:
90009-R70-A00)
Zinc

Thread: M14-1.5
Hex: 17mm
Length Under Head: 18mm
Washer Head O.D.: 24.5mm
Honda: Accord 1999 - On; Civic 2014 - On

UNIT PACKAGE: 5



18375
(6503433)

Plain with Rubber
Washer Face Gasket

Thread: M14-1.5
Hex: 17mm
Length Under Head: 18mm
Rubber Gasket O.D.: 28mm
Chrysler 1.5 & 2.0 Eng.

UNIT PACKAGE: 2



19141
(6504018)

Plain with Rubber
Washer Face Gasket

Thread: M14-1.5
Hex: 13mm
Length Under Head: 20mm
Rubber Gasket O.D.: 28mm
Chrysler 2.0, 2.4, 2.7, 3.2, 3.5, 3.7 & 4.7 Eng. 2000 - On

UNIT PACKAGE: 2



19279
(F6TZ-6730BA)
Phosphate with
Rubber Gasket

Thread M14-1.5
Hex: 13mm
Length Under Head: 20mm
Washer Head O.D.: 28mm
Chrysler with 2.0(F), 2.4(B,G,8), 2.7(R,T), 3.3(G,S,3) &
3.5(G,4) Eng. 2000 - On
Ford Aerostar, Explorer &
Ranger 6 Cylinder 4 Ltr. Eng. 1996-On

UNIT PACKAGE: 2

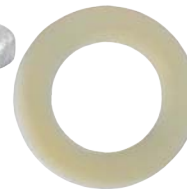

14678
Zinc

Thread: M14-1.5
Hex: 16mm
Length Under Head: 20mm
Washer Head O.D.: 25mm

Fits the following M14-1.5 applications:
AMC 4 Cylinder VW 121 Eng. 79-77
Chevrolet 4 Cylinder 1.8 (Diesel) Eng. 81-On
Chrysler Corp. (Exc. Imports): 4 Cylinder All 78-On
Chrysler Corp. Imports: 4 Cylinder All 83-On
4 Cylinder K & W Engines (built after 10-81) 82
Ford Motor Co.: 4 & 6 Cylinder 98, 122,
140, 171 Eng. 73-On
Honda 4 Cylinder Prelude 83-On
Mazda 4 Cylinder All 72-On
Pontiac 4 Cylinder 1.8 (Diesel) 83-On
Volkswagen 4 Cylinder All
(Water Cooled Engine) 74-On

UNIT PACKAGE: 5



19773
(F75Z-6730-BA)
Phosphate with
Rubber Gasket

Thread: M14-1.5
Hex: 16mm
Length Under Head: 20mm
Washer Head O.D.: 28mm
Ford Vans & Trucks with 6.8L Eng. 2000-96

UNIT PACKAGE: 1

OIL & TRANSMISSION DRAIN PLUGS WITH GASKETS



20746

(N90813201)

Zinc with Sems® Gasket

Thread: M14-1.5

Hex: 19mm

Length Under Head: 20mm

Sems® Washer O.D.: 20mm

Audi Cabriolet & Quattro with 1.8,1.9, 2.0, 2.7, 2.8, & 3.0 Eng.; VW Beetle, Eurovan, Golf, Jetta, Passat & Touareg with 1.8, 1.9, 2.0, 2.8, 3.2 & 4.0 Eng.

UNIT PACKAGE: 2



24235

Zinc

Thread: M16-1.5

Hex: 19mm

Length Under Head: 13mm
Washer Head O.D.: 26.55mm
Mini Cooper, Dodge & Eagle

UNIT PACKAGE: 2



21354

(6507741-AA)

Zinc with
Rubber Gasket

Thread: M14-1.5

Hex: 13mm

Length Under Head: 21mm

Washer Head O.D.: 29mm

Chrysler

UNIT PACKAGE: 2



24269

(Subaru: 803916210)

Zinc

Thread: M16-1.5

Hex: 17mm

Length Under Head: 16mm
Washer Head O.D.: 23.65mm
Subaru

UNIT PACKAGE: 5



18026

(601-997-02-30)

Yellow Zinc

Thread: M14-1.5

Hex: 13mm

Length Under Head: 24mm

Washer Head O.D.: 19mm

Mercedes: 300 Series

UNIT PACKAGE: 2



15528

Zinc

Thread: M16.4-1.33 O.S.

Hex: 19mm

Length Under Head: 13mm

Washer Head O.D.: 26mm

Fits the following M16.4 O.S. applications:
Nissan All (Exc. Sentra, Stanza & Pulsar with FWD 62-On
Renault: Fuego & Le Car 80-On

UNIT PACKAGE: 5



21326

(Subaru: 807016160,

803916010;

Toyota: SU003-02194)

Zinc

Thread: M16-1.5

Hex: 14mm

Length Under Head: 9mm

Washer Head O.D.: 24mm

Subaru: Legacy & Outback 2.5L; Scion: FR-S 2.0L 2013

UNIT PACKAGE: 2



24219

(Toyota:

90341-18006)

Zinc

Thread: M18-1.5

Hex: 24mm

Length Under Head: 11mm

UNIT PACKAGE: 2

OIL & TRANSMISSION DRAIN PLUGS WITH GASKETS



24218
(Toyota: 90341-18016)
Zinc

Thread: M18-1.5
Hex: 10mm
Length Under Head: 12mm
Washer Head O.D.: 26mm

UNIT PACKAGE: 2

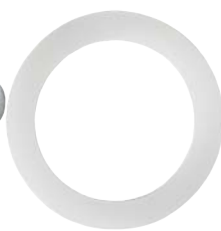

15530
Zinc

Thread: M20-1.5
Hex: 17mm
Length Under Head: 15mm
Washer Head O.D.: 27mm
Fits the following M20-1.5 applications:
Chevrolet Truck: Luv 82-75; Subaru: All 79-On
Honda: All exc. Prelude 73-On

UNIT PACKAGE: 5



15529
Zinc

Thread: M18-1.5
Hex: 19mm
Length Under Head: 12mm
Washer Head O.D.: 29mm
Fits the following M18-1.5 applications:
Chrysler: All imports 70-On; Renault: Le Car 79-76
Toyota: All 75-On

UNIT PACKAGE: 5



24264
(Smart Fortwo: 017 990 30 01)
Zinc
Smart Plug with Mesh



Thread: M22-1.5
Hex: 24mm
Length Under Head: 11mm
(+60mm Mesh)
Washer Head O.D.: 33.35mm

UNIT PACKAGE: 1



24262
Black

Thread: M18-1.5
Hex: 17mm
Length Under Head: 18mm
Washer Head O.D.: 23mm
Volvo

UNIT PACKAGE: 2



24261
(Dodge: 5080631AA)
Plain with Rubber
Washer Face Gasket

Thread: M18-1.5
Internal Square Hex
Length Under Head: 18mm
Washer Head O.D.: 30mm
Dodge

UNIT PACKAGE: 2



24236
Zinc

Thread: M22-1.5
Hex: 19mm
Length Under Head: 12mm
Washer Head O.D.: 27mm

UNIT PACKAGE: 2

OIL & TRANSMISSION DRAIN PLUGS WITH GASKETS

24257
(Chrysler: 4778578)
Zinc



Thread: M22-1.5
Hex: 10mm
Length Under Head: 18mm
Washer Head O.D.: 33.66mm
Dodge Ram

UNIT PACKAGE: 2



24221
Zinc

Thread: M22-1.75
Hex: Square Countersunk
Length Under Head: 11mm
Washer Head O.D.: 24mm

UNIT PACKAGE: 2

21041
(028-103-059-A)
Zinc



Thread: M24-1.5
Drive: 10mm Allen
Length Under Head: 10mm
Head Diameter: 32mm
Audi Cabriolet, A6, A8, Avant, Quattro,
RS6, S4, S6 & S8; VW Phaeton 6.0L & V8 4.2L and
Touareg 4.2L

UNIT PACKAGE: 1



22344
(BMW: 11-13-7-605-018)
Black Plastic

Plastic Oil Drain Plug
With Rubber Gasket
Thread: M24-1.5
Head Diameter: 36mm
Length Under Head: 11mm
Internal Hex Drive: 10mm
BMW: 228i, 320i, 328i, 428i, 528i,
X1 & Z4 2014 - On

UNIT PACKAGE: 1

18027
Zinc

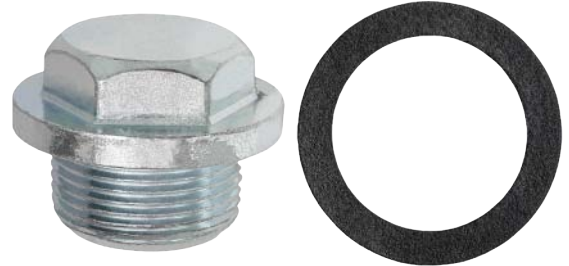

Thread: M25-1.5
Hex: 24mm
Length Under Head: 13mm
Washer Head O.D.: 35mm
Toyota

UNIT PACKAGE: 1

24247
Yellow Zinc



Thread: M26-1.5
Hex: 9/16"
Length Under Head: 13mm
Washer Head O.D.: 35mm
Mercedes

UNIT PACKAGE: 2

OIL & TRANSMISSION DRAIN PLUGS WITH GASKETS

24222
 (Honda: 90066-PC8-010)
 Yellow Zinc

Thread: M32-1.5
 Hex: 17mm
 Length Under Head: 13mm
 Washer Head O.D.: 40mm
 Honda

UNIT PACKAGE: 2

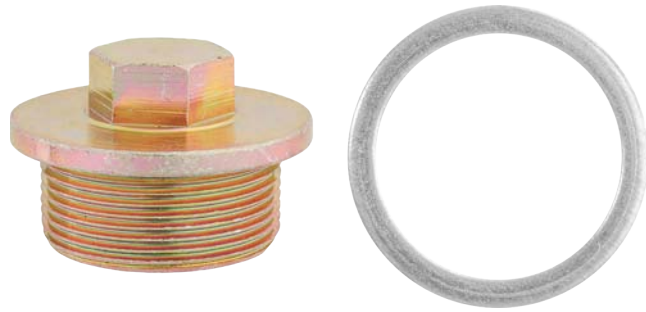

MAGNETIC OIL DRAIN PLUGS WITH GASKETS

Zinc Plated



19365



17145

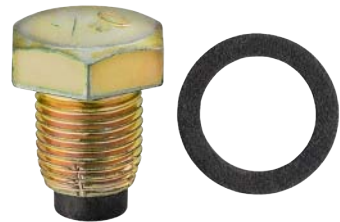

17146



17147



17148



24238

Auveco Part No.	Thread Size	Hex	Length Under Head	Finish	Unit Pkg.
19365	1/2"-20	3/4"	43/64"	Zinc	1
17145	1/2"-20 Single Oversize	3/4"	13/16"	Zinc	2
17146	1/2"-20 Double Oversize	3/4"	13/16"	Zinc & Yellow	2
17147	1/2"-20 Triple Oversize	3/4"	13/16"	Black Zinc	2
17148	M12-1.75	13mm	19mm	Zinc	2
24238	M14-1.25	19mm	20mm	Zinc	5

OVERSIZE "PIGGY-BACK" DRAIN PLUGS WITH GASKET

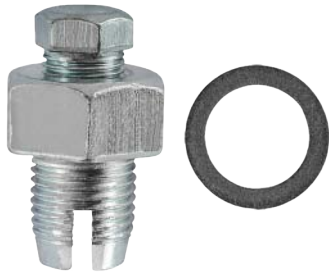

11782
Zinc

Thread: 1/2"-20
Single Oversize

UNIT PACKAGE: 5



11783
Zinc & Yellow

Thread: 1/2"-20
Double Oversize

UNIT PACKAGE: 5

25046
(Ford: HC3Z-9J305-A)
Yellow Nylon with 2 O-Rings

**Fuel Separator
Drain Plug**
Diameter: 42mm
Overall Length: 53mm
Thumb Drive

Ford F250SD, F350SD, F450SD, F550SD 2017 - On

UNIT PACKAGE: 1



25047
(Hyundai & Kia:
45286-3B010)
Black Nylon

**Transmission Oil Level
Drain Plug with Gasket**
Diameter: 35mm
Square Drive: 10mm
Overall Length: 25mm
Use with Gasket
Part No. 25048

Hyundai Azera 2016-2006; Elantra 2015-2010; Kona 2019-2018; Santa Fe 2009 - On; Sonata 2009-On; Tucson 2019-2009; Veloster 2014-2011
Kia Cadenza 2019-2013; Forte 2016-2009;
Optima 2011-On; Sedona 2006-On; Sorrento 2009-On;
Soul 2013-2012; Sportage 2010-On; Telluride 2020-On

UNIT PACKAGE: 1



25048
(Hyundai & Kia: 45285-3B010)
Black Rubber

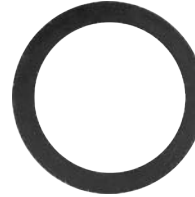

**Transmission Oil Level
Drain Plug Gasket**

Inner Diameter: 20mm
Outer Diameter: 26mm
Thickness: 6mm
Replacement Gasket
for Part No. 25047

Hyundai Azera 2016-2006; Elantra 2015-2010;
Kona 2019-2018; Santa Fe 2009-On; Sonata 2009-On;
Tucson 2019-2009; Veloster 2014-2011
Kia Cadenza 2019-2013; Forte 2016-2009;
Optima 2011-On; Sedona 2006-On; Sorrento 2009-On;
Soul 2013-2012; Sportage 2010-On; Telluride 2020-On

UNIT PACKAGE: 5



24246
Zinc

Thread: 1/2"-20
Hex: 3/4"
Length Under Head:
9/16"

UNIT PACKAGE: 2



24245
Zinc

Thread: M12-1.25 O.S.
Hex: 19mm
Length Under Head:
13mm

UNIT PACKAGE: 5



24244
Yellow Zinc

Thread: M12-1.75 O.S.
Hex: 19mm
Length Under Head:
13mm

UNIT PACKAGE: 5



24243
Zinc

Thread: M14-1.5 O.S.
Hex: 19mm
Length Under Head:
13mm

UNIT PACKAGE: 5

OVERSIZE OIL PAN DRAIN PLUGS WITH FIBRE GASKETS

Self-Tapping



Auveco Part No.	Size	Finish	Unit Pkg.
19587	1/2"-20, Single Oversize	Zinc	5
18121	1/2"-20, Double Oversize	Zinc & Yellow	5
18122	1/2"-20, Triple Oversize	Black Zinc	5
8285	5/8"-18, Single Oversize	Zinc	5
8286	11/16"-20, Single Oversize	Zinc	5
8288	3/4"-16, Single Oversize	Zinc	5
8289	7/8"-14, Single Oversize	Zinc	5
19618	M12-1.25, Single Oversize	Zinc	5
20759	M12-1.50, Single Oversize	Zinc	5
19619	M12-1.75, Single Oversize	Zinc	5
19620	M14-1.50, Single Oversize	Zinc	5

GREASE FITTINGS

Also available in Large Bulk Quantities



Ref. No: **1792**

1/4"-28, Straight
Thread Length: 9/64"
Overall Length: 1/2"
Ball Check, Plated

15055	Unit Pkg:	50
15074	Unit Pkg:	250
15440	Unit Pkg:	1000



Ref. No: **530**

1/4"-28, Straight
Self-Tapping
Overall Length: 9/16"
Ball Check, Plated

15000	Unit Pkg:	50
15068	Unit Pkg:	250
15069	Unit Pkg:	500



Ref. No: **1636**

1/4"-28, 45°
Thread Length: .3"
Overall Length: 1"
Ball Check, Plated

15056	Unit Pkg:	25
15076	Unit Pkg:	100
15077	Unit Pkg:	250



Ref. No: **1641**

1/4"-28, Straight
Thread Length: 7/32"
Overall Length: 9/16"
Ball Check, Plated

9257	Unit Pkg:	50
15100	Unit Pkg:	250
15101	Unit Pkg:	500
15415	Unit Pkg:	1000



Ref. No: **1743**

1/4" Drive Fit, Straight
Overall Length: 1/2"
Ball Check, Plated

15054	Unit Pkg:	25
15072	Unit Pkg:	100
15439	Unit Pkg:	1000



Ref. No: **1652**

1/4"-28 Straight
Overall Length: 11/16"
Ball Check, Plated

9258	Unit Pkg:	50
15102	Unit Pkg:	250
15103	Unit Pkg:	500
15416	Unit Pkg:	1000



Ref. No: **1952**

1/4" Drive Fit, Straight
Overall Length: 27/64"
No Check Valve, Plated

15065	Unit Pkg:	50
15094	Unit Pkg:	250
15450	Unit Pkg:	1000



Ref. No: **1911**

1/4"-28, 90°
Overall Length: 45/64"
Ball Check, Plated

9261	Unit Pkg:	25
15108	Unit Pkg:	100
15109	Unit Pkg:	250



Ref. No: **1680**

1/4"-28, Straight
Overall Length: 15/16"
Ball Check, Plated

9259	Unit Pkg:	25
15104	Unit Pkg:	100
15417	Unit Pkg:	1000



Ref. No: **1637**

1/4"-28, 45°
Overall Length: 29/32"
Ball Check, Plated

9260	Unit Pkg:	25
15106	Unit Pkg:	100
15107	Unit Pkg:	250
15418	Unit Pkg:	1000



Ref No: **5590**

1/4"-28, 90°
Self-Tapping
Overall Length: 43/64"
Ball Check, Plated

19176	Unit Pkg.	25
19177	Unit Pkg.	100
19178	Unit Pkg.	250



Ref No: **1610**

1/8" Pipe, Straight
Overall Length: 5/8"
Ball Check, Plated

9262	Unit Pkg:	50
15110	Unit Pkg:	250
15111	Unit Pkg:	500
15420	Unit Pkg:	1000

WARNING: ALL ITEMS ON PAGE Cancer and Reproductive Risk - www.P65Warnings.ca.gov

Sec. 13

GREASE FITTINGS

Also available in Large Bulk Quantities



Ref. No: **1688**
 1/8" Pipe, 45°
 Overall Length: 1"
 Ball Check, Plated

9264	Unit Pkg:	25
15114	Unit Pkg:	100
15115	Unit Pkg:	250
15422	Unit Pkg:	1000



Ref. No: **1612**
 1/8" Pipe, 65°
 Overall Length: 7/8"
 Ball Check, Plated

9265	Unit Pkg:	25
15116	Unit Pkg:	100
15117	Unit Pkg:	250



Ref No: **1607**
 1/8" Pipe, Straight
 Overall Length: 1-1/4"
 Ball Check, Plated

9267	Unit Pkg:	25
15120	Unit Pkg:	100
15121	Unit Pkg:	250



Ref. No: **5570**
 1/8" Pipe, Straight
 Self-Tapping
 Overall Length: 39/64"
 Nominal Hole Size: 3/8"
 Ball Check, Plated

15066	Unit Pkg:	25
15096	Unit Pkg:	100
15097	Unit Pkg:	250



Ref. No: **1613**
 1/8" Pipe, 90°
 Overall Length: 53/64"
 Ball Check, Plated

9266	Unit Pkg:	25
15118	Unit Pkg:	100
15119	Unit Pkg:	250
15424	Unit Pkg:	1000



Ref. No: **1728**
 3/16" Drive Fit, Straight
 Overall Length: 1/2"
 Ball Check, Plated

15060	Unit Pkg:	50
15084	Unit Pkg:	250
15085	Unit Pkg:	500



Ref. No: **1711**
 5/16"-24, Straight
 Overall Length: 5/8"
 Ball Check, Plated

15057	Unit Pkg:	25
--------------	-----------	----



Ref. No: **1608**
 5/16" Drive Fit, Straight
 Overall Length: 9/16"
 Ball Check, Plated

15061	Unit Pkg:	50
15086	Unit Pkg:	250
15087	Unit Pkg:	500
15446	Unit Pkg:	1000



Ref. No: **1710**
 3/8"-24, Straight
 Overall Length: 5/8"
 Ball Check, Plated

15058	Unit Pkg:	25
15080	Unit Pkg:	100



Ref. No: **1627**
 1/4" Pipe, Straight
 Overall Length: 27/32"
 Ball Check, Plated

15059	Unit Pkg:	25
15082	Unit Pkg:	100
15083	Unit Pkg:	250
15444	Unit Pkg:	1000















Ref. No: **1629**
 1/4" Pipe, 65°
 Overall Length: 1"
 Ball Check, Plated

15062	Unit Pkg:	10
15088	Unit Pkg:	50
15089	Unit Pkg:	100

Email your product suggestions to
mail@auveco.com

METRIC GREASE FITTINGS

Also available in Large Bulk Quantities

	<p>Ref No: 8601</p> <p>6mm-1.00, Straight DIN 71412 Overall Length: 14mm Ball Check, Plated</p>				
<p>1109 15122 15123 15426</p>	<p>Unit Pkg: 5 Unit Pkg: 50 Unit Pkg: 100 Unit Pkg: 1000</p>				
	<p>Ref. No: 7045</p> <p>6mm-1.00, 45° Overall Length: 22mm Ball Check, Plated</p>				
<p>11775 15132 15133</p>	<p>Unit Pkg: 10 Unit Pkg: 50 Unit Pkg: 100</p>				
	<p>Ref No: 7090</p> <p>6mm-1.00, 90° Overall Length: 18mm Ball Check, Plated</p>				
<p>11776 15134 15135</p>	<p>Unit Pkg: 10 Unit Pkg: 50 Unit Pkg: 100</p>				
	<p>Ref No: 8901</p> <p>8mm-1.00, Straight DIN 71412 Overall Length: 15mm Ball Check, Plated</p>				
<p>11098 15124 15125</p>	<p>Unit Pkg: 5 Unit Pkg: 50 Unit Pkg: 100</p>				
	<p>Ref No: 7445</p> <p>8mm-1.00, 45° Overall Length: 23mm Ball Check, Plated</p>				
<p>11777 15136 15137</p>	<p>Unit Pkg: 10 Unit Pkg: 50 Unit Pkg: 100</p>				
	<p>Ref No: 7490</p> <p>8mm-1.00, 90° DIN 71412 Overall Length: 18mm Ball Check, Plated</p>				
<p>11099 15126 15127</p>	<p>Unit Pkg: 5 Unit Pkg: 50 Unit Pkg: 100</p>				
	<p>Ref No: 9201</p> <p>8mm-1.25, Straight Overall Length: 15mm Ball Check, Plated</p>				
<p>11778 15138 15139 15434</p>	<p>Unit Pkg: 10 Unit Pkg: 50 Unit Pkg: 100 Unit Pkg: 1000</p>				
	<p>Ref No: 7545</p> <p>8mm-1.25, 45° Overall Length: 23mm Ball Check, Plated</p>				
<p>11779 15140 15141</p>	<p>Unit Pkg: 10 Unit Pkg: 50 Unit Pkg: 100</p>				
	<p>Ref No: 7590</p> <p>8mm-1.25, 90° Overall Length: 18mm Ball Check, Plated</p>				
<p>11780 15142 15143</p>	<p>Unit Pkg: 10 Unit Pkg: 50 Unit Pkg: 100</p>				
	<p>Ref No: 9301</p> <p>10mm-1.00, Straight DIN71412 Overall Length: 15mm Ball Check, Plated</p>				
<p>11100 15128 15129</p>	<p>Unit Pkg: 5 Unit Pkg: 50 Unit Pkg: 100</p>				
	<p>Ref No: 9345</p> <p>10mm-1.00, 45° Overall Length: 23mm Ball Check, Plated</p>				
<p>15067 15098</p>	<p>Unit Pkg: 25 Unit Pkg: 100</p>				
	<p>Ref No: 9390</p> <p>10mm-1.00, 90° DIN 71412 Overall Length: 19mm Ball Check, Plated</p>				
<p>11101 15130 15131</p>	<p>Unit Pkg: 5 Unit Pkg: 50 Unit Pkg: 100</p>				
	<p>Ref. No: 9501</p> <p>10mm-1.5 Straight Overall Length: 15mm Ball Check, Plated</p>				
<p>17555</p>	<p>Unit Pkg: 50</p>				

WARNING: ALL ITEMS ON PAGE Cancer and Reproductive Risk -
www.P65Warnings.ca.gov

DIFFERENTIAL COVER PLUG, GREASE FITTING TOOL, GUNS & ACCESSORIES

DIFFERENTIAL COVER PLUG



24215

Rubber
(Chrysler: 3723687)

Differential Cover Plug
Fits in 22mm Hole
Length Under Head: 11mm

UNIT PACKAGE: 10

GREASE FITTING TOOL, GUNS & ACCESSORIES

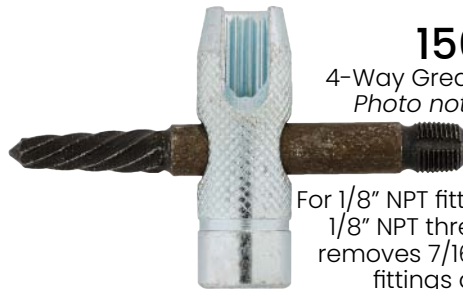

15694

4-Way Grease Fitting Tool
Photo not actual size

For 1/8" NPT fittings. Tap repairs 1/8" NPT threads. Wrench removes 7/16" and 3/8" hex fittings and plugs. Installs new 1/8" NPT fittings. "Easy Out" removes broken fittings.

UNIT PACKAGE: 1



15689

Heavy Duty Grease Gun
Coupler with Ball Check

Fits 1/8" NPT Threads
Working pressure: 5,000 PSI
Overall Length: 1-7/16"
For hand operated lube equipment only

UNIT PACKAGE: 1

Grease Gun Hoses 1/8" NPT Male Fittings

Photo not actual size



15691

12"
3000 PSI

UNIT PACKAGE: 1

15692

18"
3000 PSI

UNIT PACKAGE: 1

16276

Photo not actual size



Heavy Duty Grease Gun

3-Way Loading
Uses 14.5 oz. Cartridge, 16 oz. Bulk Capacity
10,000 PSI Working Pressure
3 Claw Coupler

UNIT PACKAGE: 1

Grease Fitting Caps

Polyethylene caps that snap over fittings to seal out dirt and moisture. Integral ring keeps cap in place during servicing.



18109

Black

UNIT PACKAGE: 50



18110

Red

UNIT PACKAGE: 50



18111

Yellow

UNIT PACKAGE: 50



15688

Grease Gun Coupler
with Ball Check

Fits 1/8" NPT Threads
Working pressure: 3,000 PSI
Overall Length: 1-3/8"
For hand operated lube equipment

UNIT PACKAGE: 1



Hex Head Pipe Plugs
Cold Rolled Steel
Plain Finish

Auveco Part No.	O.E.M. No.	Pipe Size	Unit Pkg.
9278	GM: 444613	1/8"-27	25
9279	GM: 444619, GM: 444620	1/4"-18	25



Socket Head Pipe Plugs
Cold Rolled Steel
Plain Finish

Auveco Part No.	O.E.M. No.	Pipe Size	Unit Pkg.
9282	GM: 9427882	1/8"-27	25
9283	GM: 444776	1/4"-18	25
9285	GM: 444667, GM: 444789	1/2"-14	25

BRASS FITTINGS

Inverted Flare Fittings



Inverted Nut
Brass

Auveco Part No.	Tube Size	Unit Pkg.
30	3/16"	10
31	1/4"	10
32	5/16"	10
33	3/8"	10



Inverted Nut
Steel

Auveco Part No.	Tube Size	Unit Pkg.
35	1/8"	10
36	3/16"	10
37	1/4"	10
38	5/16"	10
39	3/8"	10



Steel Plug

Auveco Part No.	Tube Size	Unit Pkg.
45	3/16"	10
46	1/4"	10
47	5/16"	10



Male Connector
Brass

Auveco Part No.	Tube Size	Pipe Thread	Unit Pkg.
49	1/8"	1/8"	5
50	3/16"	1/8"	5
51	1/4"	1/8"	5
52	5/16"	1/8"	5
53	3/8"	1/4"	5



Union
Brass

Auveco Part No.	Tube Size	Unit Pkg.
69	3/16"	5
70	1/4"	5



90° Male Elbow
Brass

Auveco Part No.	Tube Size	Pipe Thread	Unit Pkg.
75	3/16"	1/8"	5
76	1/4"	1/8"	5
77	5/16"	1/8"	5
78	3/8"	1/4"	5



45° Male Elbow
Brass

Auveco Part No.	Tube Size	Pipe Thread	Unit Pkg.
91	1/4"	1/8"	5

WARNING: Cancer and Reproductive Risk - www.P65Warnings.ca.gov

COUNTERSUNK, SQUARE, HEX HEAD PIPE PLUGS



24251
Zinc w/Sealant

Countersunk
Thread: 1/16"-27
Length: 1/4"

UNIT PACKAGE: 25



24252
Zinc w/Sealant

Countersunk
Thread: 1/8"-27
Length: 5/16"

UNIT PACKAGE: 25



24214
Zinc w/Sealant

Countersunk
Thread: 1/4"-18
Length: 7/16"

UNIT PACKAGE: 25



24253
Plain

Countersunk
Thread: 3/8"-18
Length: 3/8"

UNIT PACKAGE: 25



24254
Zinc w/Sealant

Countersunk
Thread: 3/8"-18
Length: 3/8"

UNIT PACKAGE: 25



24212
Plain

Square Countersunk
Thread: 3/8"-18
Length: 7/16"

UNIT PACKAGE: 25



24250
Brass

Countersunk
Thread: 3/8"-18
Length: 7/16"

UNIT PACKAGE: 10



24207
(GM: 15032997)
Aluminum w/Sealant

Hex Head
Thread: 3/8"-18
Hex: 3/4"
Length: 1/2"

UNIT PACKAGE: 10



24210
Plain

Square Countersunk
Thread: 1/2"-14
Length: 1/2"

UNIT PACKAGE: 10



24217
Aluminum w/Sealant

Square Countersunk
Thread: 1/2"-14
Length: 9/16"

UNIT PACKAGE: 10



24256
Zinc w/Sealant

Countersunk
Thread: 1/2"-14
Length: 9/16"

UNIT PACKAGE: 25



24255

Countersunk
Thread: 1/2"-14
Length: 9/16"

UNIT PACKAGE: 25



24208
Zinc w/Sealant

Square Countersunk
Thread: 1/2"-14
Length: 5/8"

UNIT PACKAGE: 5

COUNTERSUNK, SQUARE, HEX HEAD & METRIC PIPE PLUGS



24211
Plain

Square Countersunk
Thread: 3/4"-14
Length: 9/16"

UNIT PACKAGE: 25



24213
Plain

Square Head
Thread: 3/4"-14
Hex: 5/8"
Length: 5/8"

UNIT PACKAGE: 10

METRIC PIPE PLUGS



24278

Yellow Zinc w/Sealant

Socket Head
Thread: M8-1.0
Hex: 4mm
Length: 8mm

UNIT PACKAGE: 25



24283

Yellow Zinc w/Sealant

Socket Head
Thread: M18-1.5
Hex: 8mm
Length: 10mm

UNIT PACKAGE: 10



24279

Yellow Zinc w/Sealant

Socket Head
Thread: M10-1.0
Hex: 5mm
Length: 8mm

UNIT PACKAGE: 25



24284

Yellow Zinc w/Sealant

Socket Head
Thread: M20-1.5
Hex: 10mm
Length: 10mm

UNIT PACKAGE: 10



24280

Yellow Zinc w/Sealant

Socket Head
Thread: M12-1.5
Hex: 6mm
Length: 10mm

UNIT PACKAGE: 10



24285

Yellow Zinc w/Sealant

Socket Head
Thread: M22-1.5
Hex: 10mm
Length: 10mm

UNIT PACKAGE: 10



24281

Yellow Zinc w/Sealant

Socket Head
Thread: M14-1.5
Hex: 7mm
Length: 10mm

UNIT PACKAGE: 10



24286

Yellow Zinc w/Sealant

Socket Head
Thread: M24-1.5
Hex: 12mm
Length: 12mm

UNIT PACKAGE: 10



24282

Yellow Zinc w/Sealant

Socket Head
Thread: M16-1.5
Hex: 8mm
Length: 10mm

UNIT PACKAGE: 10

BRITISH PIPE PLUGS



24270

Yellow Zinc w/Sealant

**British Pipe Plug
Socket Head**
Thread: 1/8"-28
Hex: 5mm
Length: 8mm

UNIT PACKAGE: 25



24273

Yellow Zinc w/Sealant

**British Pipe Plug
Socket Head**
Thread: 1/4"-19
Hex: 7mm
Length: 10mm

UNIT PACKAGE: 10



24272

Plain

**British Pipe Plug
Socket Head**
Thread: 1/4"-19
Hex: 7mm
Length: 10mm

UNIT PACKAGE: 25



24274

Yellow Zinc w/Sealant

**British Pipe Plug
Socket Head**
Thread: 3/8"-19
Hex: 8mm
Length: 10mm

UNIT PACKAGE: 25

JAPANESE PIPE PLUGS & PAN BOLTS



24287

Yellow Zinc w/Sealant

**Japanese Pipe Plug
Socket Head**
Thread: 1/8"-28
Hex: 5mm
Length: 8mm

UNIT PACKAGE: 25



24289

Yellow Zinc w/Sealant

**Japanese Pipe Plug
Socket Head**
Thread: 3/8"-19
Hex: 8mm
Length: 12mm

UNIT PACKAGE: 10



24288

Yellow Zinc w/Sealant

**Japanese Pipe Plug
Socket Head**
Thread: 1/4"-19
Hex: 6mm
Length: 11mm

UNIT PACKAGE: 10



24224

Zinc

Thread: 1/4"-20
Hex: 3/8"
Length Under Head: 1/2"
Washer Head: O.D.: 17/32"

UNIT PACKAGE: 25



24227

Zinc

Thread: M8-1.25
Hex: 13mm
Length Under Head: 14mm
Washer Head O.D.: 17mm

UNIT PACKAGE: 10



24225

Zinc

Thread: 5/16"-18
Hex: 1/2"
Length Under Head: 5/8"
Washer Head O.D.: 21/32"

UNIT PACKAGE



24232

Black Phosphate

Thread: M14-1.5
Hex: 16mm
Length Under Head: 11mm
Washer Head O.D.: 25mm

UNIT PACKAGE: 5



24226

Zinc

Thread: M6-1.0
Hex: 10mm
Length Under Head: 12mm
Washer Head O.D.: 14.15mm

UNIT PACKAGE: 25

BRASS FITTINGS

Compression Fittings



Sleeve Brass

Auveco Part No.	Tube Size	Unit Pkg.
101	1/8"	25
102	3/16"	25
103	1/4"	25
105	3/8"	25
107	1/2"	10



Nut Brass

Auveco Part No.	Tube Size	Unit Pkg.
111	3/16"	10
112	1/4"	10
114	3/8"	10



Union Brass

Auveco Part No.	Tube Size	Unit Pkg.
150	1/8"	5
151	3/16"	5
152	1/4"	5
153	5/16"	5
154	3/8"	5
155	1/2"	5



Male Elbow Brass

Auveco Part No.	Tube Size	Pipe Thread	Unit Pkg.
158	1/8"	1/8"	5
159	3/16"	1/8"	5
161	1/4"	1/4"	5
163	5/16"	1/4"	5
164	3/8"	1/8"	5
168	1/2"	1/2"	5

Sec. 13

BRASS FITTINGS

Compression Fittings



**Male Connector
Brass**

Auveco Part No.	Tube Size	Pipe Thread	Unit Pkg.
119	1/8"	1/8"	5
120	3/16"	1/8"	5
121	1/4"	1/8"	5
122	1/4"	1/4"	5
123	5/16"	1/8"	5
124	5/16"	1/4"	5
125	3/8"	1/8"	5
126	3/8"	1/4"	5
127	3/8"	3/8"	5



**Union Tee
Brass**

Auveco Part No.	Tube Size	Unit Pkg.
186	3/16"	5
187	1/4"	5
189	3/8"	5

Double Compression Fittings

Threaded Sleeve



**Nut
Brass**

Auveco Part No.	Tube Size	Unit Pkg.
192	1/8"	10
193	3/16"	10
194	1/4"	10



**Male Connector
Brass**

Auveco Part No.	Tube Size	Pipe Thread	Unit Pkg.
198	1/8"	1/8"	5
200	1/4"	1/8"	5
201	5/16"	1/8"	5



**S.A.E. Flare Nut
Short • Brass**

Auveco Part No.	Tube Size	Unit Pkg.
221	1/4"	5
223	3/8"	5



**Male Elbow
Brass**

Auveco Part No.	Tube Size	Pipe Thread	Unit Pkg.
230	1/4"	1/8"	5
231	1/4"	1/4"	5
232	5/16"	1/8"	5
233	5/16"	1/4"	5



**Union
Brass**

Auveco Part No.	Tube Size	Unit Pkg.
245	5/16"	5
246	3/8"	5
247	1/2"	5



**Male Connector
Brass**

Auveco Part No.	Tube Size	Pipe Thread	Unit Pkg.
263	5/16"	1/8"	5
264	5/16"	1/4"	5
265	3/8"	1/4"	5
266	3/8"	1/8"	5
268	1/2"	3/8"	5

**Refer to page 336 for
Pipe Thread Identification**

WARNING: ALL ITEMS ON PAGE Cancer and Reproductive Risk - www.P65Warnings.ca.gov

BRASS FITTINGS

Pipe Fittings



**Cap
Brass**

Auveco Part No.	Pipe Thread	Unit Pkg.
287	1/8"	5
288	1/4"	5



**Slotted Plug
Brass**

Auveco Part No.	Pipe Thread	Unit Pkg.
289	1/8"	5



**Square Head Plug
Brass**

Auveco Part No.	Pipe Thread	Unit Pkg.
291	1/8"	5
292	1/4"	5
293	3/8"	5
294	1/2"	5



**Hex Head Plug
Brass**

Auveco Part No.	Pipe Thread	Unit Pkg.
295	1/8"	5
296	1/4"	5
297	3/8"	5
298	1/2"	5



**Bushing
Brass**

Auveco Part No.	External Pipe Thread	Internal Pipe Thread	Unit Pkg.
299	1/4"	1/8"	5
300	3/8"	1/8"	5
301	3/8"	1/4"	5
302	1/2"	1/8"	5
303	1/2"	1/4"	5
304	1/2"	3/8"	5



**Close Nipple
Brass**

Auveco Part No.	Length	Pipe Thread	Unit Pkg.
305	3/4"	1/8"	5
306	7/8"	1/4"	5
307	1"	3/8"	5
308	1-1/8"	1/2"	5



**Long Nipple
Brass**

Auveco Part No.	Length	Pipe Thread	Unit Pkg.
309	1-1/2"	1/8"	5
310	2"	1/8"	5
311	2-1/2"	1/8"	5
313	1-1/2"	1/4"	5
314	2"	1/4"	5



**Hex Nipple
Brass**

Auveco Part No.	Pipe Thread A	Pipe Thread B	Unit Pkg.
316	1/8"	1/8"	5
317	1/4"	1/4"	5
318	1/4"	1/8"	5
319	3/8"	3/8"	5
320	3/8"	1/8"	5
321	3/8"	1/4"	5
322	1/2"	1/2"	5



**Adapter
Brass**

Auveco Part No.	Pipe Thread A	Pipe Thread B	Unit Pkg.
325	1/8"	1/8"	5
326	1/4"	1/8"	5
327	1/4"	1/4"	5
328	3/8"	1/4"	5
330	1/2"	3/8"	5



**Coupling
Brass**

Auveco Part No.	Pipe Thread	Unit Pkg.
331	1/8"	5
332	1/4"	5
333	3/8"	5
334	1/2"	5

WARNING: ALL ITEMS ON PAGE Cancer and Reproductive Risk - www.P65Warnings.ca.gov

BRASS FITTINGS

Pipe Fittings



Reducing Coupling
Brass

Auveco Part No.	Pipe Thread A	Pipe Thread B	Unit Pkg.
335	1/4"	1/8"	5
336	3/8"	1/8"	5
337	3/8"	1/4"	5
339	1/2"	3/8"	5



Union
Brass

Auveco Part No.	Pipe Thread	Unit Pkg.
341	1/4"	5



90° Street Elbow
Brass

Auveco Part No.	Internal Pipe Thread	External Pipe Thread	Unit Pkg.
342	1/8"	1/8"	5
343	1/4"	1/4"	5
344	3/8"	3/8"	5



45° Street Elbow
Brass

Auveco Part No.	Pipe Thread	Unit Pkg.
347	1/8"	5
348	1/4"	5
349	3/8"	5



90° Pipe Elbow
Brass

Auveco Part No.	Internal Pipe Thread	Unit Pkg.
350	1/8"	5
351	1/4"	5
352	3/8"	5



Cross
Brass

Auveco Part No.	Pipe Thread	Unit Pkg.
353	1/8"	5



Tee
Brass

Auveco Part No.	Pipe Thread	Unit Pkg.
355	1/8"	5
356	1/4"	5

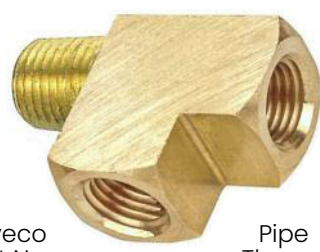

Street Tee
Brass

Auveco Part No.	Pipe Thread	Unit Pkg.
359	1/8"	5
360	1/4"	5

PIPE THREAD IDENTIFICATION



1/8"



1/4"



3/8"



1/2"

WARNING: ALL ITEMS ON PAGE Cancer and Reproductive Risk - www.P65Warnings.ca.gov

BRASS FITTINGS

Drain Cocks and Valves



**External Seat
Brass**

Auveco Part No.	Pipe Thread	Unit Pkg.
370	1/8"	5
371	1/4"	5
372	3/8"	5



**Compression Line
Brass**

Auveco Part No.	Tube Size	Unit Pkg.
385	1/4"	3



**Angle Bib Drain
Brass**

Auveco Part No.	Pipe Thread	Height	Unit Pkg.
374	1/4"	1-11/16"	5



**Ground Plug Drain
Brass**

Auveco Part No.	Pipe Thread	Unit Pkg.
405	1/8"	5
406	1/4"	5



**Female Pipe
Ground Plug Line
Brass**

Auveco Part No.	Pipe Thread	Unit Pkg.
401	1/4"	3



**Beaded Hose Barb
90° Elbow Tube
to Male Pipe**

Auveco Part No.	I.D. Hose Size	Pipe Thread	Unit Pkg.
464	5/8"	1/2"	3
465	3/4"	1/2"	2



**Beaded Hose Barb
Tube to Male Pipe**

Auveco Part No.	I.D. Hose Size	Pipe Thread	Unit Pkg.
413	3/8"	3/8"	5
415	1/2"	3/8"	5
416	5/8"	3/8"	5
417	5/8"	1/2"	5
418	3/4"	1/2"	5

WARNING: ALL ITEMS ON PAGE Cancer and Reproductive Risk - www.P65Warnings.ca.gov



Hose Barb to Taper Male Pipe

Auveco Part No.	I.D. Hose Size	Pipe Thread	Unit Pkg.
424	3/16"	1/8"	10
425	1/4"	1/8"	10
426	1/4"	1/4"	10
427	1/4"	3/8"	5
428	5/16"	1/8"	10
429	5/16"	1/4"	5
430	3/8"	1/8"	10
431	3/8"	1/4"	10
432	3/8"	3/8"	5
433	1/2"	1/4"	5
434	1/2"	3/8"	5
435	1/2"	1/2"	5



Hose Barb to Taper Female Pipe

Auveco Part No.	I.D. Hose Size	Pipe Thread	Unit Pkg.
437	1/4"	1/4"	5
438	5/16"	1/4"	5
440	3/8"	1/4"	5



Hose Barb 90° Elbow Tube to Male Pipe

Auveco Part No.	I.D. Hose Size	Pipe Thread	Unit Pkg.
455	1/4"	1/8"	5
456	1/4"	1/4"	5
457	3/8"	1/4"	5



Barbed Hose Coupler

Auveco Part No.	I.D. Hose Size	Overall Length	Unit Pkg.
419*	3/16"	1.44"	5
420	1/4"	2.00"	5
421	5/16"	2.00"	5
422	3/8"	2.00"	5
423	1/2"	2.00"	5

* 3 Barb Design

STAY UP TO DATE WITH AUVECO

We release new items once a month. Our new item bulletin will keep your catalog up to date!

To receive new item emails, please contact customer service at mail@auveco.com

You can view all our previous new item releases on our website at auveco.com



Brazier Head Solid Aluminum Rivets

Auveco Part No.	Diameter	Length	Head Diameter	Unit Pkg.
9643	3/16"	3/8"	15/32"	100
9644	3/16"	3/8"	15/32"	1000
12528	3/16"	1/2"	15/32"	100
12529	3/16"	1/2"	15/32"	1000
9647	1/4"	3/8"	5/8"	100
9648	1/4"	3/8"	5/8"	1000

Refer to pages 363 for
Drill Bits used with
Rivets



Pan'l Blind Rivets



Dome Head

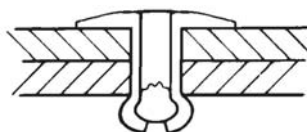

Large Flange

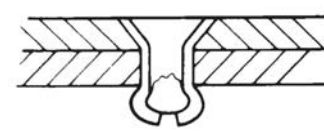

Countersunk

Auveco Part No.					Head (Flange)		Rivet Grip Range	Rivet Length Exc. Flange	Cross Reference	
Unit	Package	Quantity	Type & Diameter	Rivet Diameter	POP*	Marson Klik-Fast				
25	50	100	500	1000						
Steel Rivet & Mandrel •Plated										
		19045			Dome 3/16"	3/32"	1/8" - 1/4"	23/64"	SD34BS	SB3-4
		19046			Dome 1/4"	1/8"	1/32" - 1/16"	13/64"	SD41BS	SB4-1
		5749	5748		Dome 1/4"	1/8"	1/16" - 1/8"	7/32"	SD42BS	SB4-2
		5751	5750	8872	Cntrsnk 7/32"	1/8"	1/16" - 1/8"	7/32"	SK42BS	SC4-2
		8291	8290	8873	Lg Flange 3/8"	1/8"	1/16" - 1/8"	7/32"	SD42BSLF	SBL4-2
		8874			Dome 1/4"	1/8"	1/8" - 3/16"	5/16"	SD43BS	SB4-3
		5753	5752	8877	Dome 1/4"	1/8"	3/16" - 1/4"	25/64"	SD44BS	SB4-4
		8303	8302		Cntrsnk 7/32"	1/8"	3/16" - 1/4"	25/64"	SK44BS	SC4-4
		8293	8292	8879	Lg Flange 3/8"	1/8"	3/16" - 1/4"	25/64"	SD44BSLF	SBL4-4
		8880	8881	8882	Dome 1/4"	1/8"	5/16" - 3/8"	1/2"	SD46BS	SB4-6
		19047			Dome 1/4"	1/8"	3/8" - 1/2"	41/64"	SD48BS	SB4-8
		8883			Dome 5/16"	5/32"	1/16" - 1/8"	7/32"	SD52BS	SB5-2
		8886	8887	8888	Dome 5/16"	5/32"	3/16" - 1/4"	3/8"	SD54BS	SB5-4
		8889			Dome 3/8"	3/16"	1/16" - 1/8"	9/32"	SD62BS	SB6-2
		8892		8894	Dome 3/8"	3/16"	1/8" - 1/4"	7/16"	SD64BS	SB6-4
		8895		8897	Dome 3/8"	3/16"	1/4" - 3/8"	9/16"	SD66BS	SB6-6
		8305	8304	8898	Lg Flange 5/8"	3/16"	1/4" - 3/8"	9/16"	SD66BSLF	SBL6-6
		8899	8900	8901	Dome 3/8"	3/16"	3/8" - 1/2"	11/16"	SD68BS	SB6-8
		8902	8903		Dome 3/8"	3/16"	1/2" - 5/8"	13/16"	SD610BS	SB6-10
		21402			Dome 1/2"	1/4"	5/8" - 3/4"	1"	SD812BS	
		19048			Dome 1/2"	1/4"	3/4" - 1"	1-15/64"	SD816BS	

(Continued on next page)

Sec. 14

PAN'L BLIND RIVETS

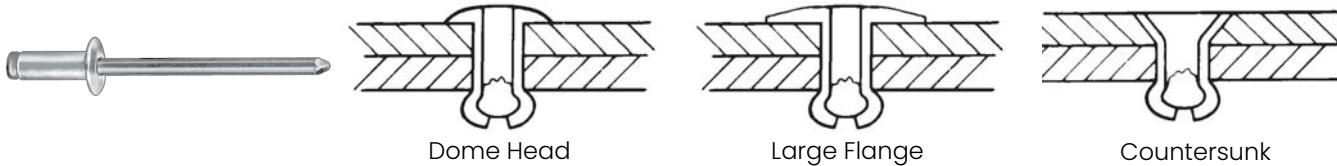

Auveco Part No.				Head (Flange)	Rivet	Grip	Rivet	Cross Reference	
Unit	Package	Quantity	Type & Diameter					Diameter	Range
25	50	100	500	1000					

Aluminum Rivet • Steel Mandrel

8905				Dome 1/4"	1/8"	1/16" - 1/8"	7/32"	AD42BS	AB4-2
8911	8912	8913		Dome 1/4"	1/8"	3/16" - 1/4"	3/8"	AD44BS	AB4-4
8914	8915			Cntrsnsk 7/32"	1/8"	3/16" - 1/4"	3/8"	AK44BS	AC4-4
19049				Dome 1/4"	1/8"	3/8" - 1/2"	41/64"	AD48BS	AB4-8
19050				Dome 5/16"	5/32"	3/16" - 1/4"	27/64"	AD54BS	AB5-4
8295	8294	8917		Dome 3/8"	3/16"	1/16" - 1/8"	9/32"	AD62BS	AB6-2
8307	8306	8918		Dome 3/8"	3/16"	1/8" - 1/4"	3/8"	AD64BS	AB6-4
8297	8296	8919		Dome 3/8"	3/16"	1/4" - 3/8"	9/16"	AD66BS	AB6-6
19051				Lg Flange 5/8"	3/16"	3/8" - 1/2"	11/16"	AD68BSLF	ABL6-8

Aluminum Rivet & Mandrel

19053				Dome 3/16"	3/32"	1/32" - 1/8"	15/64"	AD32ABS	AB3-2A
8309	8308	8920		Dome 1/4"	1/8"	1/16" - 1/8"	7/32"	AD42ABS	AB4-2A
8299	8298			Cntrsnsk 7/32"	1/8"	1/16" - 1/8"	7/32"	AK42ABS	AC4-2A
8922				Lg Flange 3/8"	1/8"	1/16" - 1/8"	7/32"	AD42ABSLF	ABL4-2A
8925	8926	8927		Dome 1/4"	1/8"	3/16" - 1/4"	3/8"	AD44ABS	AB4-4A
8928	8929			Cntrsnsk 7/32"	1/8"	3/16" - 1/4"	3/8"	AK44ABS	AC4-4A
8931	8932	8933		Lg Flange 3/8"	1/8"	3/16" - 1/4"	3/8"	AD44ABSLF	ABL4-4A
16031				Dome 1/4"	1/8"	5/16" - 3/8"	1/2"	AD46ABS	AB4-6A
16032				Dome 1/4"	1/8"	3/8" - 1/2"	5/8"	AD48ABS	AB4-8A
20474				Lg. Flange 3/8"	1/8"	3/8" - 1/2"	5/8"		ABL4-8A
18727				Dome 5/16"	5/32"	1/16" - 1/8"	9/32"	AD52ABS	AB5-2A
18728				Dome 5/16"	5/32"	1/8" - 3/16"	11/32"	AD53ABS	AB5-3A
18729				Dome 5/16"	5/32"	3/16" - 1/4"	13/32"	AD54ABS	AB5-4A
18732				Lg Flange 15/32"	5/32"	3/16" - 1/4"	13/32"	AD54ABSLF	
18730				Dome 5/16"	5/32"	1/4" - 3/8"	1/2"	AD56ABS	AB5-6A
18731				Dome 5/16"	5/32"	3/8" - 1/2"	5/8"	AD58ABS	AB5-8A
5755	5754	8934		Dome 3/8"	3/16"	1/16" - 1/8"	9/32"	AD62ABS	AB6-2A
8311	8310	8935		Dome 3/8"	3/16"	1/8" - 1/4"	7/16"	AD64ABS	AB6-4A
19055				Lg Flange 5/8"	3/16"	1/8" - 1/4"	7/16"	AD64ABSLF	ABL6-4A
	8300	8936		Dome 3/8"	3/16"	1/4" - 3/8"	9/16"	AD66ABS	AB6-6A
	8312	8937		Lg Flange 5/8"	3/16"	1/4" - 3/8"	9/16"	AD66ABSLF	ABL6-6A
8938	8939	8940		Dome 3/8"	3/16"	3/8" - 1/2"	11/16"	AD68ABS	AB6-8A
19056				Lg Flange 5/8"	3/16"	3/8" - 1/2"	11/16"	AD68ABSLF	ABL6-8A
18489				Dome 3/8"	3/16"	1/2" - 5/8"	13/16"	AD610ABS	AB6-10A
19057				Lg Flange 5/8"	3/16"	1/2" - 5/8"	13/16"	AD610ABSLF	ABL6-10A
19058				Dome 1/2"	1/4"	1/4" - 3/8"	39/64"	AD86ABS	AB8-6A

Stainless Steel Rivet & Mandrel

19060				Dome 1/4"	1/8"	3/16" - 1/4"	25/64"	SSD44SSBS	SSB4-4S
19061				Dome 3/8"	3/16"	3/8" - 1/2"	11/16"	SSD68SSBS	SSB6-8S

Stainless Steel Rivet • Steel Mandrel

Replaces Ford No.: 383229-S

To replace welded studs on body. (Use Auveco Rivet Gun 7915 with 7981 Nose Piece.)

11104	11105	11106		Sm. Flange 3/16"	1/8"	3/16" - 1/4"	5/16"	R4357	SSBN4-3
-------	-------	-------	--	------------------	------	--------------	-------	-------	---------



Steel Rivet Washers
Zinc

16791

Outer Diameter: 1/2"
For 1/8" Diameter

UNIT PACKAGE: 100

15973

Outer Diameter: 1/2"
For 5/32" Diameter

UNIT PACKAGE: 100

16792

Outer Diameter: 15/32"
For 3/16" Diameter

UNIT PACKAGE: 100

7915

Pan'l Rivet Gun

Photo not actual size



Overall Length: 9-1/2"
With 3/32", 1/8", 5/32" and 3/16" nose pieces

UNIT PACKAGE: 1



Nose Pieces
For Auveco Rivet Gun 7915

Auveco Part No.	Description	Unit Pkg.
7981	Use with 1/8" rivet 11104 to replace welded studs	1
7983	For 1/8" diameter rivets	1
7984	For 5/32" diameter rivets	1
7985	For 3/16" diameter rivets	1



19132

Nose piece for 1/8" standard rivets

UNIT PACKAGE: 1



19133

Nose piece for 3/16" standard rivets

UNIT PACKAGE: 1



19134

Nose piece for 1/4" standard rivets

UNIT PACKAGE: 1



11853

Nose piece for 1/4" "Peel Type" rivets.

UNIT PACKAGE: 1



14799

Replacement jaws repair kit for

UNIT PACKAGE: 1



21655

Nose Piece
For 3/16" Monobolts

UNIT PACKAGE: 1



19066
Rivet Gun

Photo not actual size

Overall Length: 21"
With nose pieces for 3/32", 1/8", 5/32",
3/16" & 1/4" diameter rivets.

UNIT PACKAGE: 1



13756

Rivet Setter Gun
For Nylon Rivets

For use with nylon
(plastic) blind rivets.

A durable tool that sets all sizes with a single stroke.
All steel construction.
Not for use with metal rivets.
Length: 6-1/2"

UNIT PACKAGE: 1

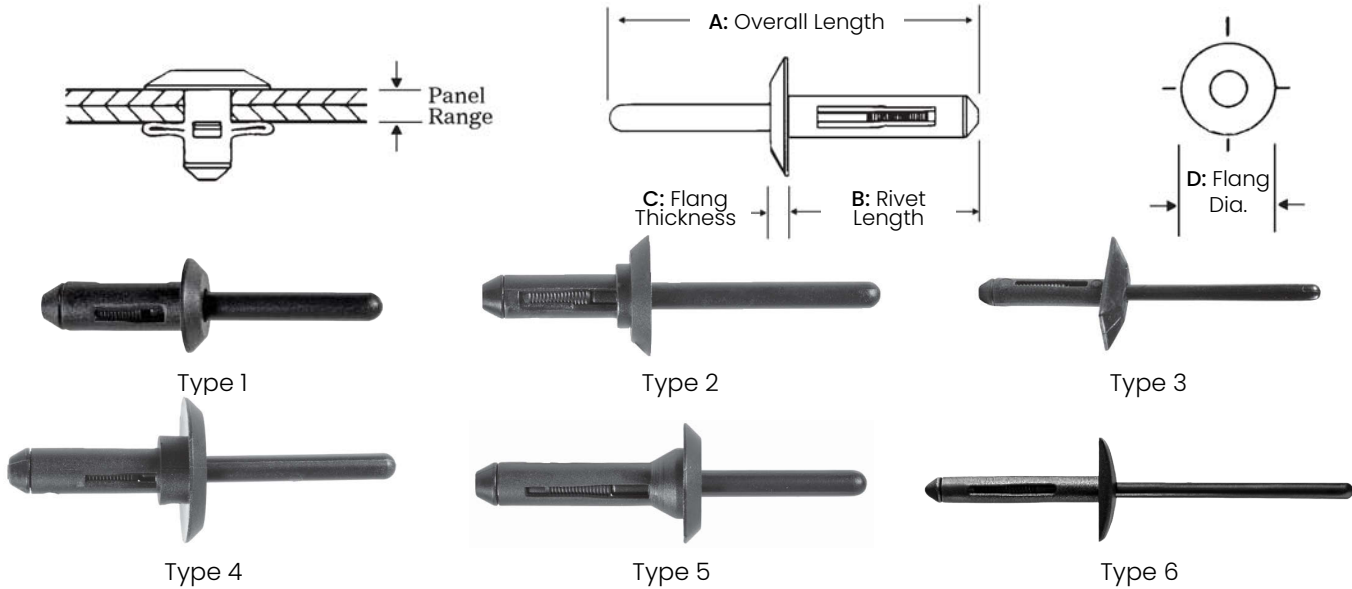

Auveco Part No.	Type	Color	O.E.M. Number	Hole Diameter	Panel Range (Grip)	A	B	C	D	Unit Pkg.
17220	3	Black	GM: 21094747	5/32"	7/64"-7/32"	1-7/8"	3/4"	3/32"	**	50
22923	1	Black	General Purpose	4mm	1.5mm-4.5mm	48mm		2.5mm	8mm	50
15187	6	Black	Ford: N804583S	4mm	6mm-10.5mm	65mm	26mm	2.5mm	***	25
13746	1	Black	GM: 20612732	3/16"	1/16"-9/64"	1-7/8"	23/32"	3/32"	11/32"	25
18501	1	Black	Chry: 6502689	3/16"	5/32"-1/4"	1-27/32"	21/32"	1/16"	11/32"	25
21327	1	Black	GM: 11588308	4.95mm	3mm - 6mm	48mm	18mm	1.7mm	9mm	25
13747	1	Black	GM: 20423647, Ford: N804189S	13/64"	1/16"-11/64"	1-7/8"	23/32"	1/8"	15/32"	25
14005	1	Black	GM: 20465395, Chry: 6004212	13/64"	1/8"-5/32"	1-13/16"	21/32"	1/16"	11/32"	25
13748	1	Black	GM: 20432975 VW:175-853-57701C, Chry: 6503800, Ford: N804343S	13/64"	1/8"-15/64"	1-7/8"	25/32"	1/16"	15/32"	25
13755	1	Black	Chry: 6500898 GM: 15718794	13/64"	15/64"-25/64"	2"	1"	1/16"	15/32"	25
14004	1	Black	GM: 25524005	15/64"	11/64"-11/32"	2-3/64"	1-1/8"	3/32"	1/2"	25
14023	1	Black	GM: 10036503	15/64"	5/32"-5/16"	2-1/8"	1-5/32"	3/32"	5/8"	25
18913	1	Black	Chry: 6503938	15/64"	5/32"-9/32"	2-5/32"	1-1/16"	3/32"	1/2"	25
20754	1	Black	BMW: 51-71-7-002-953-2	6mm	2.5mm-4.8mm	53mm	22mm	2.5mm	20mm	25
18028	2	Black	Chry: 4630088	1/4"	1/32"-11/64"	2-3/16"	13/16"	3/32"	21/32"	25
18031	2	Black*	Chry: 4630660	1/4"	1/32"-3/16"	2-1/8"	3/4"	3/32"	21/32"	25
18242	5	Black	Chry: 6501509	1/4"	3/64"-3/16"	2-7/32"	1-1/8"	3/32"	25/32"	25
13749	1	White	GM: 14070914	1/4"	5/32"-15/64"	2-3/16"	23/32"	3/32"	21/32"	25
21446	1	Black	Chry: 6508444-AA	1/4"	5/32"-15/64"	2-3/16"	1-1/8"	3/32"	1-1/32"	15
18502	1	Black	General Purpose	1/4"	5/32"-1/4"	2-3/16"	23/32"	3/32"	21/32"	25
21028	1	Black	GM: 15614746	1/4"	5/32"-3/8"	2-3/16"	1-1/8"	3/32"	21/32"	25
18108	1	Black	Chry: 34201631	1/4"	5/32"-3/8"	2-7/32"	1-1/8"	3/32"	11/16"	25
17496	1	Gray	AMC: 8934-201-835	1/4"	5/32"-3/8"	2-7/32"	1-1/8"	3/32"	11/16"	25
14012	1	White	GM: 15506827	1/4"	5/32"-13/32"	2"	1-1/8"	3/32"	21/32"	25

* Black Rivet Body, White Mandrel

** 5/16" x 19/32"

*** 8.5mm x 15.5mm

(Continued on next page)

AUTOMOTIVE O.E.M. NYLON BLIND RIVETS

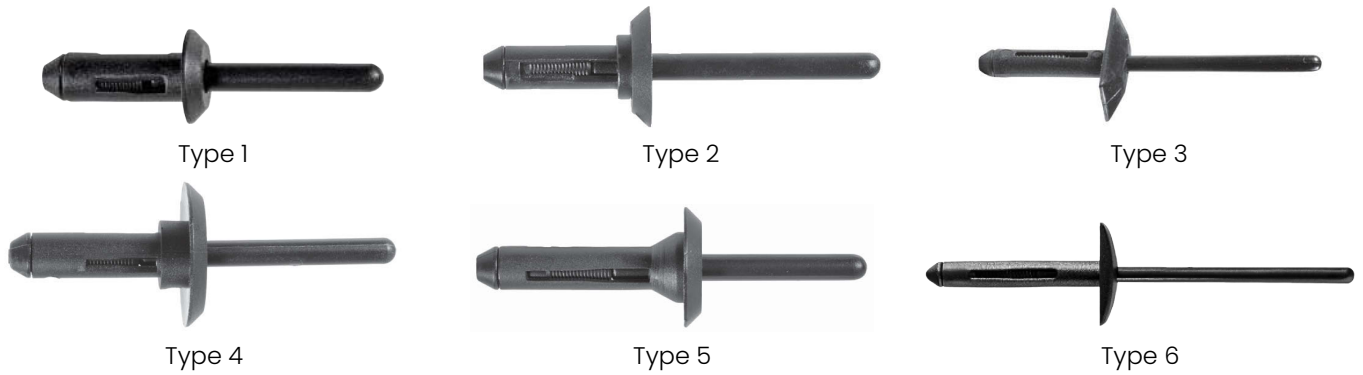

Auveco Part No.	Type	Color	O.E.M. Number	Hole Diameter	Panel Range (Grip)	A	B	C	D	Unit Pkg.
13751	1	Black	GM: 10184895 Ford: N803862-S Chry: 6501559,6506007-AA	1/4"	5/32"-13/32"	2-3/16"	1-3/32"	3/32"	1/2"	25
13750	1	Black	GM: 14063981 Ford: N803043-S Chry: 6500911, 6504700	1/4"	5/32"-13/32"	2-3/16"	1-3/32"	3/32"	21/32"	25
15491	1	Black	Ford: N804759-S	1/4"	19/64"-27/64"	2-1/8"	13/16"	3/32"	21/32"	25
17101	1	Black	Ford: N804675S Chry: 4370138, 6503860	1/4"	5/16"-15/32"	2-9/32"	1-1/4"	3/32"	21/32"	25
23992	1	Black	Chry: 6504737	6.3mm	4-7mm				13mm	25
13752	1	Black	GM: 15955172, 20421672	17/64"	3/32"-3/16"	1-7/8"	25/32"	3/32"	1/2"	25
13753	1	Black	GM: 20433026 VW: 175-853-577A	17/64"	3/32"-3/16"	1-7/8"	25/32"	3/32"	23/32"	25
15490	1	Black	GM: 10109689, 12337915	9/32"	3/32"-15/64"	2-3/16"	15/16"	3/32"	23/32"	25
22917	1	White	BMW: 07-14-7-378-241	6mm	3.0mm-8.0mm				12.5mm	25

Note: Use rivet guns 13756 to install all of the above rivets.

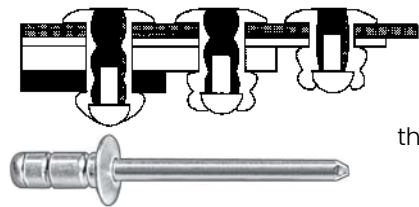

POP® MULTI-GRIP BLIND RIVETS

Functions in a Wide Range of Material Thickness

The Multi-Grip rivet will serve in applications where solid, soft materials and thicknesses normally require several rivet sizes. Oversize, irregular or misaligned holes are automatically compensated for by self-adjusting hole-filling capability. The mandrel head is retained in the rivet body, forming a tight, weather resistant seal.

Auveco Part No.	Head Style & Diameter	Rivet Diameter	Hole Size	Grip Range	Rivet Length Excluding Flange	Unit Pkg.	Pop® No.
Aluminum Rivet • Steel Mandrel							
19033	Large Flange 3/8"	1/8"	.129"-.142"	3/64"-3/16"	21/64"	100	AD41-43BSLF
19025	Dome 1/4"	1/8"	.129"-.142"	5/32"-5/16"	15/32"	100	AD43-45BS
19034	Large Flange 3/8"	1/8"	.129"-.142"	5/32"-5/16"	15/32"	100	AD43-45BSLF
18743	Dome 5/16"	5/32"	.160"-.173"	3/64"-1/4"	13/32"	100	AD52-54BS
17468	Large Flange 15/32"	5/32"	.160"-.173"	3/64"-1/4"	13/32"	50	AD52-54BSLF
19027	Dome 5/16"	5/32"	.160"-.173"	1/8"-5/16"	1/2"	50	AD53-55BS
18744	Dome 3/8"	3/16"	.192"-.205"	1/16"-1/4"	7/16"	50	AD62-64BS
19036	Large Flange 5/8"	3/16"	.192"-.205"	1/16"-1/4"	7/16"	50	AD62-64BSLF
19028	Dome 3/8"	3/16"	.192"-.205"	3/16"-3/8"	5/8"	50	AD63-66BS
19037	Large Flange 5/8"	3/16"	.192"-.205"	1/4"-1/2"	47/64"	50	AD66-68BSLF
19031	Dome 1/2"	1/4"	.261"-.275"	5/64"-11/32"	39/64"	25	AD82-86BS

What makes Avex different and better?

The Avex rivet adds important and exclusive features to those offered by ordinary blind rivets. The unique advantages designed into the Avex rivet allow for its use:

In wide-tolerance holes. Since the rivet can expand up to its own head diameter, accurate hole sizing or alignment is not necessary.

To pull sheets together. The extraordinary rivet tail expansion automatically effects superior clamp-up action on the parts being assembled.

Over a vast range of thicknesses. The "dubble-bubble" expansion feature offers the capability to fasten securely in both thick and thin grip ranges with a single length rivet.

While providing a sealed stem. The rivet material flows both behind and in front of the mandrel insuring a positively retained and sealed stem.

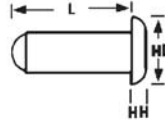

Dome Head

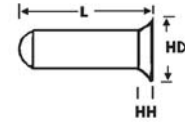

120° Countersunk

Auveco Part No. Unit Package Quantity				Head (Flange) Style	Rivet Diameter	Grip	Length L	Flange Diameter HD	Flange Height HH	Hole Size
50	100	500	1000	Countersunk	1/8"	To 1/4"	15/32"	.205"	.030"	.136"
10336	10337			Countersunk	1/8"	To 1/4"	15/32"	.205"	.030"	.136"
10357	10358	10359		Dome	3/16"	To 7/16"	23/32"	.349"	.070"	.199"
10345	10346			Countersunk	3/16"	To 1/2"	25/32"	.339"	.050"	.199"
17654	17655			Dome	1/4"	To 11/32"	21/32"	.500"	.094"	.268"

WARNING: ALL ITEMS IN CHART Reproductive Risk & Cancer www.P65Warnings.ca.gov

Avex® Brazier Head Rivet



17433
Zinc

Diameter: 3/16"
Grip: 3/16"-7/16"
Head Diameter: 15/32"
Body Length: 11/16"
Aluminum Rivet & Steel Mandrel

UNIT PACKAGE: 50

Stavex® Large Flange Rivets

- Large flange head enables soft, pliable materials to be fastened
- All steel construction (zinc plated) provides high shear and tensile values.
- Typical applications:
 - Plastic energy absorbing strip to automotive bumper
 - Plywood liners to both sidewalls and roofs in truck bodies and trailers



Auveco Part No.	Diameter	Grip	Flange Diameter	Hole Size	Unit Pkg.
16989	3/16"	1/16"-3/8"	5/8"	.192-.196"	25

Auveco Klamp-Tite Rivets

- Largest Blind Head
- Fills hole tightly
- High Clamp-Up
- Water Tight Capability
 - Fully Cored
- Structural- Self Plugging
- Head Style- Protruding

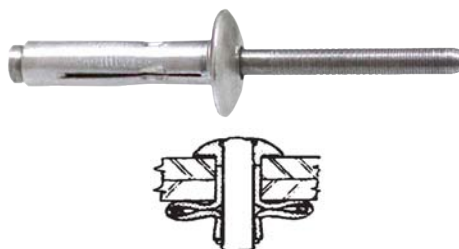

Mandrel breaks flush with top of rivet head anywhere within grip range.

Material: Rivet 5056 Aluminum, Mandrel 7075 Aluminum
Finish: Wax (Do Not Remove)

Auveco Part No.	Unit Pkg.	Rivet Diameter	Grip Range	Hole & Drill Size	Mandrel Diameter	Head Diameter	Head Thickness	Rivet Length Max
13766	50	3/16"	3/64"- 1/4"	.204-.209 (#5)	.103"	.445"	.088"	.890"
13767			3/16"- 3/8"					.985"
13768			3/8"- 9/16"					1.045"
13770	25	1/4"	3/16"- 3/8"	.252-.262 (F)	.136"	.560"	.113"	1.045"

Blind Tacking Rivets

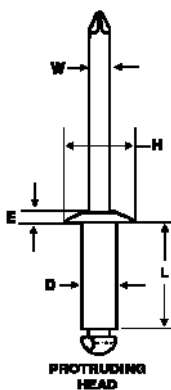

- Steel Rivet: Plated
- Non-Structural: Break mandrel rivets
 - Steel Mandrel: Coated
- Conform to IFI-114 Standards

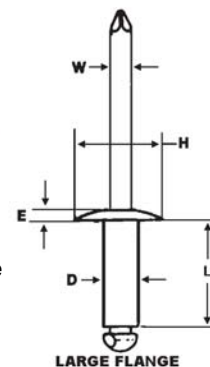

Nom. Rivet Diameter Max.	Hole Size & Drill Number	W Mandrel Diameter	D Rivet Diameter	Protruding Head		Large Flange Head	
				H Head Diameter	E Max.	H Head Diameter	E
1/4"	.257-.261 (F)	.151	.250	.500	.080	.750	.107

Auveco Part No.	Head Style	Rivet Diameter	Grip	Rivet Length L	Unit Pkg.
13796	Large Flange	1/4"	1/2"- 5/8"	13/16"	25

Large Secondary Head Rivets



Rivets that fasten securely into thick and thin materials. Will pull soft or brittle materials. Can be used in an oversized hole.

Auveco Part No.	Head (Flange) Type & Diameter	Rivet Diameter	Grip Range	Rivet Length Excluding Flange	Unit Pkg.
19062	Dome 5/16"	5/32"	0-1/4"	23/32"	25

Aluminum Rivet & Mandrel

Monobolt® Fastening System

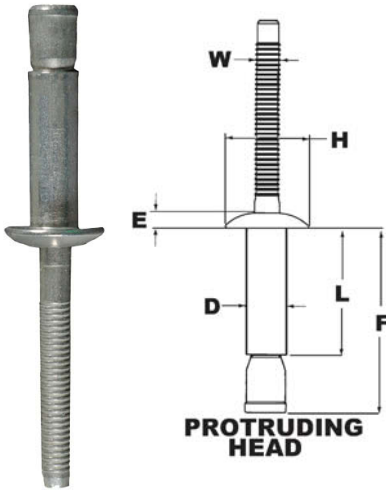

Nom. Rivet Diameter	Hole Size & Drill Number	W Mandrel Diameter	D Rivet Diameter	Protruding Head	
				H Head Diameter	E Head Max.
3/16	.191-.201 (#11)	.118	.187	.390	.070
1/4	.261-.272(G)	.157	.257	.515	.100

Typical Rivet Shear and Tensile Strength (lbs) and Mandrel push-out when installed in Nominal Grip.

Rivet Diameter	Aluminum Rivet & Mandrel			Steel Rivet & Mandrel		
	Shear	Tensile	Mandrel Push-out	Shear	Tensile	Mandrel Push-out
3/16	625	500	50	1300	1000	100
1/4	1300	890	100	2400	2150	250

Auveco Part No.	Diameter	Grip	DIM "L"	DIM "F"	Head Style	Material	Unit Pkg.
12080	3/16"	.062/.270	.406	.748	Protruding	Steel-Zinc Plated	25
12088	3/16"	.062/.270	.406	.748	Protruding	Steel-Zinc Plated	100
12081	3/16"	.214/.420	.531	.882	Protruding	Steel-Zinc Plated	25
12089	3/16"	.214/.420	.531	.882	Protruding	Steel-Zinc Plated	100
12084	1/4"	.080/.375	.550	.971	Protruding	Steel-Zinc Plated	25
12092	1/4"	.080/.375	.550	.971	Protruding	Steel-Zinc Plated	100
12085	1/4"	.350/.625	.855	1.123	Protruding	Steel-Zinc Plated	25
12093	1/4"	.350/.625	.855	1.123	Protruding	Steel-Zinc Plated	100
12086	1/4"	.080/.375	.550	.961	Protruding	Aluminum	25
12094	1/4"	.080/.375	.550	.961	Protruding	Aluminum	100
13773	1/4"	.350/.625	.810	1.174	Protruding	Aluminum	25
13774	1/4"	.350/.625	.810	1.174	Protruding	Aluminum	100

The System

Blind Installation: The single side installation feature of the Auveco Monobolt System allows one operator to produce high quality structural joints in seconds. Use of the Monobolt power tool does not require special skill or training, because the tool completely controls the installation cycle.

Multi-Grip: One size Monobolt fastener will function effectively in a wide range of material thicknesses (Example: .080" to .375"). This versatility decreases the potential for production errors and reduces fastener inventory requirements.

Uniform Clamping Action: Monobolt fasteners are engineered to draw materials together by developing positive clamping action.



Its Advantages

Structural Fastening: An installed Monobolt fastener yields high shear and tensile values. Conventional fasteners can be replaced by Monobolt without compromising structural requirements.

Positive Stem Retention: At the completion of the installation cycle, the stem is mechanically locked into the Monobolt shell, creating a vibration-proof joint of assured structural quality.

Flush Break Stem: Within the specific grip range for each size, Monobolt fastener, the stem is designed to break flush with the low profile head. Secondary finishing operations, such as grinding or milling, are not necessary to achieve good product appearance.

Complete Hole Fill: During installation, the Monobolt shell expands into 360° contact with the walls of the parent material. This feature, in conjunction with positive stem retention, produces weather resistant joints.

Quiet, Safe Installation: The Monobolt System, operating at 85db ("A" Weighted), complies with OSHA regulation governing plant noise levels and operator safety.

How it Works



1. The Monobolt fastener is loaded into the nose of the placing tool and inserted in a prepared hole. As the tool is actuated, the pulling jaws grip the Monobolt stem.

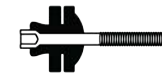

2. An axial pull draws the stem through the shell, expanding it radially. During this phase, the hole is completely filled and work pieces are drawn together.



3. When the stem reaches a pre-determined position within the Monobolt shell, it separates flush with the head profile regardless of work piece thickness. Simultaneously, the stem section remaining in the shell is mechanically locked in place by the Monobolt tool.

Interlock® Dome Head High Strength Rivets



High strength Interlock® rivets feature a positive mechanical locking system that provides superior holding power. This system also guarantees 100% mandrel retention that's visually verifiable.

Auveco Part No.	Rivet Diameter	Grip Range	Rivet Body Length	Head Diameter	Unit Pkg.	Conversion				
						Interlock®	Cherry Monobolt	Avdel Monobolt	Huck Magna-lock	
Aluminum Rivet & Mandrel										
17421	3/16"	1/16" - 17/64"	13/32"	3/8"	25	AD627OUG	BAPV-64	2774-0613	MGLP-B6-4	
17422	3/16"	1/16" - 7/16"	9/16"	3/8"	25	AD6437UGX		2774-0617	MGLP-B6-E	
17423	1/4"	5/64" - 3/8"	9/16"	1/2"	25	AD8375UG	BAPV-86	2774-0817	MGLP-B8-6	
Steel Rivet & Mandrel										
17425	3/16"	1/16" - 17/64"	13/32"	3/8"	25	SD627OUG	SSPV-64	2771-0613	MGLP-R6-4	
17427	1/4"	5/64" - 3/8"	9/16"	1/2"	25	SD8375UG	SSPV-86	2771-0817	MGLP-R8-6	



Closed - End Rivets

Can be set with Auveco Rivet Gun 7915

Auveco Part No.	Head (Flange) Type	Rivet Head Diameter	Rivet Diameter	Grip Range	Rivet Length Excluding Flange	Unit Pkg.
Black Aluminum Rivet & Mandrel						
17408	Dome	15/64"	1/8"	13/64" - 9/32"	15/32"	50
17410	Dome	3/8"	3/16"	3/8" - 1/2"	11/16"	25
Aluminum Rivet & Mandrel						
17419	Dome	3/8"	3/16"	1/16" - 1/8"	11/32"	50
17420	Dome	3/8"	3/16"	1/8" - 1/4"	15/32"	50
Aluminum Rivet & Steel Mandrel						
17411	Dome	15/64"	1/8"	1/16" - 1/8"	5/16"	50
17415	Dome	3/8"	3/16"	1/8" - 1/4"	15/32"	50
17416	Dome	3/8"	3/16"	1/4" - 3/8"	19/32"	50

"PEEL - TYPE" SPECIALTY RIVETS

Use with 11853 Nose Piece (Page 341) to set all 1/4" "Peel-Type" Rivets



19414
(W525170-S417)

"Peel-Type" Rivet
Diameter: 3/16"
Grip: 1/32"-1/4"
Flange Diameter: 1/2"
Aluminum Rivet (Black) & Steel Mandrel (Zinc)
Side Door Lock Attachment
Mercury Villager 1995 - On

UNIT PACKAGE: 25



19461
(W525172-S417)

"Peel-Type" Rivet
Diameter: 1/4"
Grip: 1/32"-7/32"
Flange Diameter: 1/2"
Aluminum Rivet (Black) & Steel Mandrel (Zinc)
Outside Door Handle
Ford Crown Victoria, Econoline, Explorer,
Grand Marquis, Ranger, Sable,
Taurus & Windstar 1995 - On

UNIT PACKAGE: 15



11620
(GM: 9436175;
Ford: 385189-S100;
Chry: 6031115)

"Peel-Type" Rivet
Diameter: 1/4"
Grip: 1/32" - 9/64"
Flange Diameter: 1/2"
Aluminum Rivet & Steel Mandrel
Window Regulators
GM, Ford & Chrysler 1971 - On

UNIT PACKAGE: 25



11852
(Ford: 388047-S100;
GM: 14078435)

"Peel-Type" Rivet
Diameter: 1/4"
Grip: 5/64" - 7/64"
Flange Diameter: 1/2"
Recess under Head
Aluminum Rivet & Steel Mandrel
Attaches Outside Door Handle
Ford 1978 - On
Heat Shield Attachment
GM

UNIT PACKAGE: 25

"PEEL - TYPE" SPECIALTY RIVETS

Use with 11853 Nose Piece

(Page 341) to set all 1/4" "Peel-Type" Rivets



12653
(388047-S102)

"Peel-Type" Rivet
Diameter: 1/4"
Grip: 3/32"-1/8"
Flange Diameter: 1/2"
Aluminum Rivet (Black) & Steel Mandrel
Door Handle Assembly
Ford 1981 - On

UNIT PACKAGE: 25
⚠️ **WARNING:** Reproductive Harm & Cancer
www.P65Warnings.ca.gov



15684
(20713843)

"Peel-Type" Rivet
Diameter: 1/4"
Grip: 7/64" - 11/64"
Flange Diameter: 1/2"
Recess under Head
Aluminum Rivet & Steel Mandrel
Used on Window Regulators
& Door Lock Assemblies
GM A & J Cars

UNIT PACKAGE: 25



12655
(GM: 9437486;
Chry: 6032926)

"Peel-Type" Rivet
Diameter: 1/4"
Grip: 9/64" - 3/16"
Flange Diameter: 1/2"
Aluminum Rivet & Steel Mandrel
Window Regulators
GM 1981 - On

UNIT PACKAGE: 25
⚠️ **WARNING:** Reproductive Harm & Cancer
www.P65Warnings.ca.gov



14486
(GM: 9437486;
Chry: 6032926)

"Peel-Type" Rivet
Diameter: 1/4"
Grip: 9/64" - 3/16"
Flange Diameter: 1/2"
Aluminum Rivet & Steel Mandrel
Used on Window Regulators,
Quarter Vent Handle Assemblies &
Electrical Door Lock Linkage
GM & Chrysler 1981 - On

UNIT PACKAGE: 25



20402
(9437643)

"Peel-Type" Rivet
Diameter: 1/4"
Grip: 3/16" - 1/4"
Flange Diameter: 1/2"
Aluminum Rivet & Steel Mandrel (Zinc)
Window Regulator
Saturn 1993 - On

UNIT PACKAGE: 25



11621
(Ford: 385323-S100; Chry: 6031091; GM: 9437938)

"Peel-Type" Rivet
Diameter: 1/4"
Grip: 33/64" - 19/32"
Flange Diameter: 1/2"
Aluminum Rivet & Steel Mandrel
Window Regulator
GM, Ford & Chrysler 1976 - On
UNIT PACKAGE: 10



19456
(W525175-S)

"Peel-Type" Rivet
Diameter: 1/4"
Grip: 25/64" - 21/32"
Flange Diameter: 5/8"
Aluminum Rivet & Steel Mandrel (Zinc)
Front Door Window
Ford Continental, Crown Victoria, Explorer, Grand
Marquis, Mark VIII, Mustang, Ranger, Sable, Taurus, Town
Car & Windstar 1996 - On
UNIT PACKAGE: 15



18167
(Ford: N804193-S100;
GM: 9441592, 15672713)

"Peel-Type" Rivet
Diameter: 1/4"
Grip: 3/32"-9/64"
Flange Diameter: 3/4"
Aluminum Rivet (Black) & Steel Mandrel
Front Door Handle & Door Lock Actuator
Tempo, Topaz, T-Bird & Cougar 1984 - On
Rocker Panel Moulding
Chevrolet Beretta & Corsica 1996 - 92
UNIT PACKAGE: 25



19458
(N808689-S417)

"Peel-Type" Rivet
Diameter: 1/4"
Grip: 1/8"-21/64"
Flange Diameter: 3/4"
Aluminum Rivet (Black) & Aluminum Mandrel
Door Lock Actuator
Ford Continental, Crown Victoria,
F Series Truck, Grand Marquis, Mark VII, Mustang,
Ranger, Sable, Taurus, Town Car & Windstar 1995 - On
UNIT PACKAGE: 10



10658

Diameter: 3/32"
Grip: 1/8"-1/4"
Flange Diameter: 3/16"
Aluminum Rivet & Mandrel
Replaces welded studs on body panels.

UNIT PACKAGE: 100

23975

(Not Available from OEM)



Blind Rivet with Trim Clip Stud
Diameter: 3/32 (2.4mm)
Flange Diameter: 0.197 (5.0mm)
Grip Range: 0.098 (2.5mm)
Aluminum Rivet & Mandrel
Replaces Weld-On Stud for Attaching Stud Style Moulding Clips to Panels

UNIT PACKAGE: 25



18499

Diameter: 1/8"
Grip: 1/8"-3/16"
Flange Diameter: 3/16"
Aluminum Rivet & Mandrel
Trim Moulding Attachment

UNIT PACKAGE: 100



18500

Diameter: 1/8"
Grip: 3/16"-1/4"
Flange Diameter: 3/16"
Aluminum Rivet & Mandrel
Trim Moulding Attachment

UNIT PACKAGE: 100



11104

(Ford: 383229-S)
Diameter: 1/8"
Grip: 3/16"-1/4"
Flange Diameter: 3/16"
Stainless Steel Rivet & Steel Mandrel
Replaces welded studs on body panels.
Use Auveco Rivet Gun 7915 & Nose Piece 7981

UNIT PACKAGE: 100

11105

Same as 11104 except for unit package quantity

UNIT PACKAGE: 500

11106

Same as 11104 except for unit package quantity

UNIT PACKAGE: 1000



7981

Rivet Gun Nose Piece
Used to set Auveco Rivet 11104

UNIT PACKAGE: 1



20788

(90269-04051,
90269-A0006)
Diameter: 1/8" (3.2mm)
Grip: 3/64" - 1/8" (1.2mm - 3.4mm)
Flange Diameter: 15/64" (6mm)
Aluminum Rivet with Plastic Cap
Steel Mandrel
Lexus 1998 - On

UNIT PACKAGE: 10



17408

(N803933-S101)

Diameter: 1/8"
Grip: 13/64"-9/32"
Flange Diameter: 15/64"
Closed End
Black Aluminum Rivet & Mandrel
Luggage Rack
Ford

UNIT PACKAGE: 50



17469

(375936-S)

Diameter: 1/8"
Grip: 1/32"-1/8"
Flange Diameter: 1/4"
Stainless Steel Rivet & Mandrel
Attaches Body Side Mouldings
Sets flush, does not leave a raised stud

UNIT PACKAGE: 100



21418

(6508540-AA)

Diameter: 1/8"
Grip: 1/32" - 3/16"
Flange Diameter: 1/4"
Black Aluminum Rivet & Steel Mandrel (Zinc)
Chrysler General Purpose

UNIT PACKAGE: 25

22437

(Hyundai: 14160-03103)



Front & Rear Bumper Specialty Rivet

Diameter: 3.2mm (1/8")
Flange Diameter: 6.3mm (1/4")
Grip Range: 0.8mm - 4.8mm (.032" - .189")
Black Aluminum Rivet & Steel Mandrel
Hyundai Accent, Genesis, Santa Fe, Sonata & Veloster and Kia Borrego, K900, Rio, Sorento & Sportage 2006 - On

UNIT PACKAGE: 25



18303

Diameter: 1/8"
Grip: 1/16"-1/8"
Flange Diameter: 1/4"
Aluminum Rivet (Black) & Aluminum Mandrel
Attachment of Rear Window Trim Moulding
Ford Explorer 1990-On
UNIT PACKAGE: 50



17470
(378527)

Diameter: 1/8"
Grip: 1/8"-3/16"
Flange Diameter: 1/4"
Aluminum Rivet & Mandrel
Attaches Climate Controls
Ford

UNIT PACKAGE: 50



17467
(375203S)

Diameter: 1/8"
Grip: 1/8"-3/16"
Flange Diameter: 1/4"
Stainless Steel Rivet & Steel Mandrel
Attaches Body Side Moulding Retainer
Sets flush, does not leave a raised stud
Ford

UNIT PACKAGE: 100



21114
(11610210)

Diameter: 1/8"
Grip: 5/32" - 5/16"
Flange Diameter: 1/4"
Aluminum Rivet & Mandrel
Rear Bumper Fascia
Chevrolet Equinox 2005 - On

UNIT PACKAGE: 50



19202

Diameter: 1/8"
Grip: 3/16"-1/4"
Flange Diameter: 1/4"
Aluminum Rivet (Black) & Aluminum Mandrel
GM & General Purpose

UNIT PACKAGE: 100



22481
(Hyundai: 14160-03133)

Front & Rear Bumper Specialty Rivet
Diameter: 3.2mm (1/8")
Flange Diameter: 6.3mm (1/4")
Grip Range: 4.0mm - 7.9mm (.158" - .311")
Black Aluminum Rivet & Steel Mandrel
Hyundai Accent, Azera, Elantra, Equus, Santa Fe,
Santa Fe Sport, Tucson & Veracruz and Kia Optima,
Rondo, Sorento & Soul 2007 - On

UNIT PACKAGE: 25



19657
(6034848)
Yellow Zinc

Diameter: 1/8"
Grip: 1/32"-3/16"
Flange Diameter: 5/16"
Aluminum Rivet & Steel Mandrel
Rocker Panel & Cladding
Chrysler LH Series 1993 - On

UNIT PACKAGE: 50



20787
(90269-04006)

Diameter: 1/8" (3.2mm)
Grip: 3/64" - 5/32" (1.2mm - 4.0mm)
Flange Diameter: 5/16" (8mm)
Aluminum Rivet with Plastic Cap
Steel Mandrel
Lexus 1998 - On

UNIT PACKAGE: 10



20627
(90269-04053)

Diameter: 1/8" (3.2mm)
Grip: 3/64" - 3/16" (1mm - 4.8mm)
Flange Diameter: 5/16" (8mm)
Aluminum Rivet (Black) with Plastic Cap
Steel Mandrel (Black)
Mouldings
Toyota Land Cruiser 1998 - On

UNIT PACKAGE: 10



19406
(6035414)

Diameter: 1/8"
Grip: 1/16"-1/4"
Flange Diameter: 5/16"
Aluminum Rivet & Steel Mandrel (Zinc)
Cladding to Fender Attachment
Chrysler Concorde, Eagle & Intrepid
1997 - On

UNIT PACKAGE: 50



12656
(20325696)

Diameter: 1/8"
Grip: 1/8" - 3/16"
Flange Diameter: 5/16"
Aluminum Rivet & Steel Mandrel
Rear Window Gasket Attachment
GM 1981 - On

UNIT PACKAGE: 50



20628
(90269-04050)

Diameter: 1/8" (3.2mm)
Grip: 5/32" - 5/16" (4mm - 8mm)
Flange Diameter: 5/16" (8mm)
Aluminum Rivet with Plastic Cap
Steel Mandrel
Windshield, Side & Trunk Moulding
Lexus GS300, 400, 430 & SC430
1998 - On

UNIT PACKAGE: 15



17615
(6032856)

Diameter: 1/8"
Grip: 3/16"-3/8"
Flange Diameter: 5/16"
Aluminum Rivet (Black) & Steel Mandrel
Body Side Moulding
& Universal Applications
Chrysler

UNIT PACKAGE: 50

23861
(15622490, 6032856)



Sealing Type, Ground Effects, Bumper Blind Rivet
Rivet Diameter: 1/8"
Flange Diameter: 3/8"
Grip Range: 0.125 - 0.375"
Black Aluminum Rivet, Stainless Steel Mandrel
GM 1997 - On
Chrysler

UNIT PACKAGE: 25



18304

Diameter: 1/8"
Grip: 1/16" - 1/8"
Flange Diameter: 3/8"
Aluminum Rivet (Black) & Steel Mandrel
Attachment of Door Glass Moulding
Ford 1993 - On

UNIT PACKAGE: 50

25341
(Audi & VW: N-910-197-01)



Windshield Retaining Strip Rivet
Diameter: 3.2mm.
Grip Range: 4mm Max
Flange Diameter: 6mm
Aluminum Rivet, Aluminum Mandrel
Audi A3 2020-2006, A4, S4 2012-2005, A5 Quattro,
S5 2011-2008, A6 2018-2005, A7 Quattro 2018-2012,
A8 Quattro 2018-2011, e-tron Quattro, Q3, Q8 2020-2019,
Q5 2011-2009, Q7 2020-2007, R8, TT 2015-2008,
RS4 2008-2007, RS7 2018-2014, S3 2020-2015,
S6 2018-2007, S7, S8 2018-2013, SQ7, SQ8 2020;
Volkswagen Arteon 2020-2019, Passat 2010-2009

UNIT PACKAGE: 25



16834
(N805759-S100)

Diameter: 1/8"
Grip: 1/8" - 3/16"
Flange Diameter: 3/8"
Aluminum Rivet (Black) & Aluminum Mandrel
Windshield Side Rail
Ford T-Bird & Mercury Cougar 1989-On

UNIT PACKAGE: 50



16686
(9432552)

Multi-Purpose Bumper Corer Rivet
Diameter: 1/8"
Grip: 1/8" - 3/16"
Flange Diameter: 3/8"
Aluminum Rivet & Steel Mandrel
Large Flange
GM 1978-On

UNIT PACKAGE: 100



19419
(N811460-S100)

Diameter: 1/8"
Grip: 1/8" - 3/16"
Flange Diameter: 3/8"
Steel Rivet (Black) & Steel Mandrel
Door Moulding
Ford Taurus 1996-On

UNIT PACKAGE: 15



21082
(75547-51021)

Diameter: 1/8" (3.2mm)
Nylon Shoulder Diameter: 1/4" (6.3mm)
Grip: 1/32" - 1/16" (.8mm - 1.5mm)
Flange Diameter: 13/32" (10.3mm)
Aluminum Rivet with Plastic Cap
Steel Mandrel
Windshield
Lexus IS 250, IS 350 & IS F 2006 - On
Toyota 2002 - On

UNIT PACKAGE: 15

25251
(Hyundai & Kia: 14160-03130)



Bumper Cover Specialty Rivet
Diameter: 3.2mm (1/8")
Flange Diameter: 6.3mm (1/4")
Grip Range: 4.0mm - 7.9mm (.158" - .311")
Aluminum Rivet & Steel Mandrel
Hyundai Equus 2011, Genesis 2011 - 2009,
Entourage 2008 - 2007; Kia K5 2021 - On,
Niro 2020 - 2017, Optima 2020 - 2006,
Sedona 2014 - 2006, Sorento 2009 - 2007,
Spectra 2009 - 2004

UNIT PACKAGE: 25



23973
(W707504-S900)

Multi Grip Style Blind Rivet
Door Glass Moulding
Diameter: 1/8" (3.2mm)
Grip: 0.157 - 0.312 (4.0mm - 7.9mm)
Flange Diameter: 3/8" (9.5mm)
Aluminum Rivet & Steel Mandrel
Ford Freestar & Monterey 2004

UNIT PACKAGE: 25

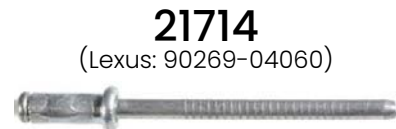

21714
(Lexus: 90269-04060)

Specialty Rivet
Diameter: 5/32" (4mm)
Grip: 3/64" - 9/32" (1mm - 7mm)
Flange Diameter: 15/64" (6mm)
Steel Rivet & Mandrel
Lexus GS 300, GS 350, GS 430, GS 450h
& GS 460 2006 - On

UNIT PACKAGE: 25

22089

(GM: 92139150)



Front Bumper & Grille Specialty Rivet

Diameter: 5/32" (4mm)
 Grip Range: 11/64" - 11/32" (4.4mm - 8.5mm)
 Flange Diameter: 9/32" (7.1mm)
 Aluminum Rivet & Stainless Steel Mandrel
 Chevrolet Camaro 2012 - On

UNIT PACKAGE: 25

22173

(GM: 11611651)

Zinc & Clear Trivalent



Door & Exterior Trim Specialty Rivet

Diameter: 5/32" (4mm)
 Grip Range: 3/64" - 5/32" (1mm - 4mm)
 Flange Diameter: 5/16" (8mm)
 Steel Rivet & Mandrel
 Cadillac ATS, CTS, CTS-V & Escalade,
 Chevrolet Avalanche, Camaro & Equinox and
 GMC Terrain 2010 - On

UNIT PACKAGE: 50

22332

(Subaru: 905920039;
 Toyota: 76879-48010)



Roof, Liftgate & Exterior Trim Specialty Rivet with Plastic Cap

Rivet Diameter: 4mm (5/32")
 Diameter of Plastic Cap: 5mm
 Flange Diameter: 8mm (5/16")
 Plastic Cap Flange Diameter:
 10mm (Top), 12mm (Bottom)
 Grip Range: .8mm - 2.4mm (.031" - .094")
 Aluminum Rivet, Steel Mandrel
 Subaru Forester, Impreza, Legacy,
 Outback & XV Crosstrek 2015 - 2009
 Toyota Prius 2009 - 2004

UNIT PACKAGE: 10

25154

(Infiniti & Nissan; 73858-AU100)



Roof Moulding Specialty Rivet with Plastic Cap

Diameter: 4mm (5/32")
 Cap Diameter: 5mm
 Grip Range: 0.6mm - 0.9mm (0.236" - 0.354")
 Flange Diameter: 6.5mm
 Cap Flange Diameter:
 Top 10mm, Bottom 8.5mm
 Aluminum Rivet & Steel Mandrel
 Infiniti FX35, FX45 2008 - 2003; JX35 2013;
 QX56 2013 - 2011; QX60, QX80 2014 - On;
 Nissan Armada 2017 - On; Murano 2003 - On;
 Pathfinder 2020 - 2013; Rouge 2020 - 2008;
 Versa 2012 - 2007; X-Trail 2021 - On

UNIT PACKAGE: 10

18461

(Ford: N807620-S100; GM: 10131511)



Split-Type Rivet

Diameter: 5/32"
 Grip: 3/64"-1/4"
 Flange Diameter: 5/16"
 Aluminum Rivet (Black) & Aluminum Mandrel
 Wheel Openings
 Lincoln 1994-On
 Bumper Cover, Grille & Rocker Moulding
 GM 1997 - On

UNIT PACKAGE: 25

20971

(Mazda: BBM450-355;
 Mercedes-Benz: 003-990-94-97)



Split-Type Rivet

Diameter: 5/32" (4mm)
 Grip: 3/64" - 9/32" (1mm - 7mm)
 Flange Diameter: 5/16" (8mm)
 Aluminum Rivet & Mandrel
 Mazda 2012 - On; Mercedes-Benz 2004 - On

UNIT PACKAGE: 25

20383

(90084-26002)



Diameter: 5/32" (4mm)
 Grip: 1/16" - 1/4" (1.6mm - 6.3mm)
 Flange Diameter: 5/16" (8mm)
 Aluminum Rivet & Mandrel
 Door Window Moulding
 Toyota Camry 1997 - On

UNIT PACKAGE: 50

16687

(GM: 9432137;
 Chry: 6032138)



Diameter: 5/32"
 Grip: 1/8"- 3/16"
 Flange Diameter: 5/16"
 Aluminum Rivet & Steel Mandrel
 Countersunk Head
 Trunk Lock Swivel Emblem Rivet
 GM 1973-On

UNIT PACKAGE: 25

21864

(Ford: W713819-S900)

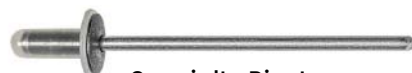

Specialty Rivet

Diameter: 5/32" (4mm)
 Grip: 3/64" - 1/8" (1.2mm - 3.2mm)
 Flange Diameter: 3/8" (9mm)
 Aluminum Rivet (Black) with Plastic Cap
 Steel Mandrel
 Cab & Exterior Trim
 Ford F-150 2014 - 2009

UNIT PACKAGE: 25

22501
(Mazda: BN8F-50-355)



Front Bumper & Grille Specialty Rivet
Diameter: 4mm (5/32")
Flange Diameter: 8mm (5/16")
Grip Range: 1mm - 13mm (3/64" - 33/64")
Aluminum Rivet & Mandrel
Mazda 3, 5, CX-3, CX-9, Miata & MX-5 2006 - On

UNIT PACKAGE: 15

22448
(Mazda: GHP9-50-355)



Bumper, Grill & Upper Bracket Specialty Rivet
Diameter: 4mm (5/32")
Flange Diameter: 8mm (5/16")
Grip Range: 5.6mm - 9.6mm (.220" - .378")
Black Aluminum Rivet & Mandrel
Mazda 6 2014 - On

UNIT PACKAGE: 25

22451
(GM: 11546343)



Front & Rear Bumper Cover Specialty Rivet
Diameter: 4mm (5/32")
Grip Range: 5mm - 12mm (.197" - .472")
Flange Diameter: 8mm (5/16")
Aluminum Rivet & Mandrel
Cadillac CT6 2016 - On
Chevrolet Camaro 2012 - On

UNIT PACKAGE: 25

22923
Black Nylon



Nylon Blind Rivet
Hole Diameter: 4mm
Grip Range: 1.5mm - 4.5mm
Flange Diameter: 8mm
Flange Height: 2.5mm
Overall Length: 48mm
General Purpose/Universal

UNIT PACKAGE: 50



20629
(6036148-AA)

Split-Type Rivet
Diameter: 5/32"
Grip: 3/64" - 1/4"
Flange Diameter: 7/16"
Aluminum Rivet (Black) & Aluminum Mandrel
Front Bumper, Trim Panel,
Instrument Panel & Running Boards
Chrysler 1999 - On

UNIT PACKAGE: 25



22088
(GM: 9132667)

Front & Rear Bumper Specialty Rivet
Diameter: 5/32" (4mm)
Grip Range: 9/64" - 3/8" (3.6mm - 9.5mm)
Flange Diameter: 7/16" (11.1mm)
Aluminum Rivet & Stainless Steel Mandrel
Buick Regal & Verano; Chevrolet Avalanche, Camaro,
Cruze, Malibu, Sonic & Volt 2010 - On

UNIT PACKAGE: 25



17468
(16715497)

Diameter: 5/32"
Grip: 3/64" - 1/4"
Flange Diameter: 15/32"
Aluminum Rivet & Steel Mandrel
Attaches Support Rails to Load Floor
GM

UNIT PACKAGE: 50



21742
(Toyota: 90269-06054)

Specialty Rivet
Diameter: 5/32" (4mm)
Grip: 3/64" - 3/8" (1mm - 9.5mm)
Flange Diameter: 15/32" (12mm)
Aluminum Rivet (Black) & Steel Mandrel (Black)
European Toyota and Universal

UNIT PACKAGE: 25



21715
(Toyota: 90269-04047)

Specialty Rivet
Diameter: 5/32" (4mm)
Grip: 3/64" - 15/32" (1mm - 12mm)
Flange Diameter: 15/32" (12mm)
Aluminum Rivet & Steel Mandrel (Black)
Black Flange
Toyota RAV4 & 4Runner 1996 - On

UNIT PACKAGE: 25



19376
(979878-6)

Diameter: 5/32" (4mm)
Grip: 1/8" - 11/32" (3mm - 8.5mm)
Flange Diameter: 15/32" (12mm)
Aluminum Rivet (Black Polyethylene Coating)
Aluminum Mandrel
Bumper & Wheel Housing
Volvo 1993-On

UNIT PACKAGE: 15



17006
(N900-845-01)

Diameter: 5/32"
Grip: 1/4" - 3/8"
Flange Diameter: 15/32"
Aluminum Rivet (Black) & Steel Mandrel
Wheel Opening Moulding Attachment
Jetta, Rabbit & Golf

UNIT PACKAGE: 25



23970
(12531204)

Rear Bumper Blind Rivet
Diameter: 5/32" (4mm)
Grip: 0.197 - 0.472 (5mm - 12mm)
Flange Diameter: 0.325 (8.25mm)
Aluminum Rivet & Mandrel
GM "F" Body 1993 - On
UNIT PACKAGE: 25



15187
(N804583S)
Black Nylon

Cowl Vent Grille Retainer Rivet
Diameter: 5/32" (4mm)
Grip: 15/64" - 13/32" (6mm-10.5mm)
Flange Size: 11/32" x 5/8" (8.5mm x 15.5mm)
Ford Aerostar 1986-On
UNIT PACKAGE: 25



24481
(9437552)

Split Type Rivet
Door Latch Assembly
Rivet Diameter: 3/16"
Grip Range: 0.079"-0.109"
Aluminum Rivet & Steel Mandrel
GM
UNIT PACKAGE: 50



18169
(15956062)

Diameter: 3/16"
Grip: 1/8"-1/4"
Flange Diameter: 11/32"
Aluminum Rivet & Steel Mandrel
Door Assembly
GM Trucks C, K Models 1994-On
UNIT PACKAGE: 25



19514
(10125439, 10201332)

Split-Type Rivet
Diameter: 3/16"
Grip: 3/64"-15/64"
Flange Diameter: 3/8"
Aluminum Rivet (Black) & Aluminum Mandrel
Door Actuator, Door, Body & Fender
Moulding and Dash Panel Insulation
Buick Regal, Chevrolet Lumina APV, K & T Trucks, Olds
Silhouette and Pontiac Trans Sport 1990 - On
UNIT PACKAGE: 25

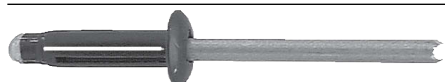

16864
(10125439)

Split-Type Rivet
Diameter: 3/16"
Grip: 3/64"-11/32"
Flange Diameter: 3/8"
Aluminum Rivet (Black) & Aluminum Mandrel
Moulding Attachment
APV Vans 1990 - On
UNIT PACKAGE: 25



22333
(Ford: W717984-S417)

Cab & Exterior Trim Countersunk Closed End Specialty Rivet
Diameter: 4.8mm (3/16")
Flange Diameter: 9.5mm (3/8")
Grip Range: 1.6mm - 3.18mm (.063" - .125")
Black Aluminum Rivet & Mandrel
Ford F-150 2015 - On

UNIT PACKAGE: 15



20830
(N-904-374-01)

Diameter: 3/16" (4.8mm)
Grip: 1/16" - 1/4" (1.6mm-6.4mm)
Flange Diameter: 3/8" (10mm)
Aluminum Rivet & Steel Mandrel
Inner Fender
Volkswagen

UNIT PACKAGE: 25



22436
(Hyundai: 14160-05130)

Windshield Moulding Specialty Rivet
Diameter: 4.8mm (3/16")
Flange Diameter: 10mm (3/8")
Grip Range: 1.6mm - 6.3mm (.063" - .250")
Aluminum Rivet & Steel Mandrel
Hyundai Azera, Equus, Genesis, Santa Fe
& Sonata and Kia Amanti & Forte 2004 - On

UNIT PACKAGE: 25



19459
(384432-S)

Diameter: 3/16"
Grip: 1/16"-1/8"
Flange Diameter: 3/8"
Aluminum Rivet & Steel Mandrel
Outer Moulding
Ford F Series & Villager
and Nissan Quest 1995 - On

UNIT PACKAGE: 25



21184
(003-990-24-97)

Door Handle, Air Bag, Rocker Moulding & Window Regulator Rivet
Diameter: 3/16" (4.8mm)
Grip: 1/16" - 1/8" (1.6mm - 3.2mm)
Flange Diameter: 3/8" (9.5mm)
Steel Rivet & Mandrel
Mercedes-Benz 1998 - On

UNIT PACKAGE: 100



21439

Diameter: M4.8 (3/16")
 Grip: 1.5mm - 6mm (1/16" - 15/64")
 Flange Diameter: 9mm (3/8")
 Steel Rivet & Mandrel
 Cadillac CTS; Chevrolet Colorado &
 Equinox and GMC Canyon & Terrain 2004 - On

UNIT PACKAGE: 50



22540

(Ford: W525157-S300)

Bumper & Lower Deflector Specialty Rivet

Diameter: 4.8mm (3/16")
 Flange Diameter: 9.3mm (3/8")
 Grip Range: 3.20mm - 6.35mm (.126" - .250")
 Aluminum Rivet & Steel Mandrel
 Ford Escape, Expedition & Taurus 2005 - On

UNIT PACKAGE: 50



18329

(3828472)

Diameter: 3/16"
 Grip: 1/4"-3/8"
 Flange Diameter: 3/8"
 Aluminum Rivet (Black) & Aluminum Mandrel
 Attachment of Front Fender Lower Rocker Moulding
 Chevrolet Astro & GMC Safari Mini-Vans 1995 - On

UNIT PACKAGE: 50



17410

(390428-S100)

Diameter: 3/16"
 Grip: 3/8"-1/2"
 Flange Diameter: 3/8"
 Closed End
 Black Aluminum Rivet & Mandrel
 Luggage Rack
 Ford

UNIT PACKAGE: 25



19515

(15704030)

Diameter: 3/16"
 Grip: 3/16"-3/8"
 Flange Diameter: 25/64"
 Aluminum Rivet (Black)
 Steel Mandrel (Yellow Zinc)
 Body Moulding, Bumper Fascia,
 Hood Prop Rod and Window Hinge
 Chev. Beretta, Camaro, Corsica &
 Trucks, Olds Silhouette, Pontiac Firebird,
 Grand Am and Trans Sport 1992 - On

UNIT PACKAGE: 25

17121
 (GM: 25618730;
 Ford: N805592-S100, W706737-S300)



Split-Type Rivet

Diameter: 3/16"
 Grip: 5/64"-15/64"
 Flange Diameter: 7/16"
 Aluminum Rivet (Black) & Aluminum Mandrel
 Wheel House Moulding & General Purpose
 Ford Fiesta, Fusion, Lincoln MKZ 2019 - 2013 &
 Ford Bronco 2021 - On

UNIT PACKAGE: 25



18927

(22569178,
 22579423)

Split-Type Rivet

Diameter: 3/16"
 Grip: 5/16" - 7/16"
 Flange Diameter: 7/16"
 Aluminum Rivet & Steel Mandrel (Zinc)
 Front & Rear Door Window Sash Attachment
 Buick Skylark, Chevrolet Cavalier,
 Olds Achieva & Pontiac Grand Am 1992-On

UNIT PACKAGE: 25



18244

(GM: 15614774)

Split-Type Rivet

Diameter: 3/16"
 Grip: 3/16"-3/8"
 Flange Diameter: 29/64"
 Aluminum Rivet (Black) & Aluminum Mandrel
 For Camper Style Mirrors on GM Trucks

UNIT PACKAGE: 10



21713

(Toyota: 90269-05034,
 90269-05056)

Specialty Rivet

Diameter: 3/16" (5mm)
 Grip: 3/64" - 15/32" (1mm - 12mm)
 Flange Diameter: 1/2" (13mm)
 Aluminum Rivet with Plastic Cap
 Steel Mandrel
 Lexus IS 300 and Toyota Celica, Corolla,
 Matrix, Prius, RAV4, Tercel & Yaris 2000 - On

UNIT PACKAGE: 25



21046

(90269-05065)

Diameter: 3/16" (5mm)
 Grip: 5/32" - 9/32" (4mm - 7mm)
 Flange Diameter: 1/2" (13mm)
 Aluminum Rivet with Plastic Cap
 Steel Mandrel
 Bumpers & General Purpose
 Lexus 2004 - On

UNIT PACKAGE: 10



17641

(9442361, 25609048)

Diameter: 3/16"
 Grip: 3/64"-13/64"
 Flange Diameter: 9/16"
 Aluminum Rivet (Black) & Steel Mandrel (Zinc)
 Used in place of screws when attaching
 new Catalytic Converter Heat Shield
 Buick LeSabre & Roadmaster, Cadillac Brougham
 and Oldsmobile 98 & 88 1986 - On

UNIT PACKAGE: 25



18749

(9439559,
21021319)

Diameter: 3/16"
 Grip: 1/16"-1/4"
 Flange Diameter: 9/16"
 Aluminum Rivet (Black) & Steel Mandrel
 Rocker Panel Cover
 GM Saturn 1991 - On

UNIT PACKAGE: 50



20834

(90269-06013)

Diameter: 3/16" (4.8mm)
 Grip: 1/16" - 1/4" (1.6mm - 6.35mm)
 Flange Diameter: 9/16" (14mm)
 Aluminum Rivet with Plastic Cap
 Steel Mandrel
 Gas Filler Door
 Toyota Camry & Lexus IS300 2001 - On

UNIT PACKAGE: 15



20626

(90269-05054)

Diameter: 3/16" (5mm)
 Grip: 1/8" - 5/16" (3mm - 8mm)
 Flange Diameter: 9/16" (14mm)
 Aluminum Rivet with Plastic Cap
 Steel Mandrel
 Windshield Side Moulding & Gas Filler Cap
 Toyota Camry & Sienna 1997 - On

UNIT PACKAGE: 10



14127

(388664-S100)

Diameter: 3/16"
 Grip: 3/8"-1/2"
 Flange Diameter: 9/16"
 Aluminum Rivet (Black) & Aluminum Mandrel
 Fascia & Bumper
 Ford 1982 - On

UNIT PACKAGE: 25



22995

(Acura/Honda: 90853-SJA-A00)

High Retention Specialty Rivet
 Diameter: 3/16" (4.8mm)
 Grip: .059" - .138" (1.5mm - 3.5mm)
 Flange Diameter: .375" (9.5mm)
 Stainless Steel Rivet & Mandrel
 Acura RDX 2019 - On; RL 2012 - 2005;
 RLX 2014 - On; TSX 2014 - 2009
 Honda Civic 2018 - 2016; HR-V 2016 - On

UNIT PACKAGE: 15



17421

(Tesla: 1028719-00-A)

Body Panel Blind Rivet
 Diameter: 3/16"
 Flange Diameter: 3/8"
 Grip Range: 1/16" - 17/64"
 Rivet Length: 13/32"
 Aluminum Rivet & Mandrel

UNIT PACKAGE: 25

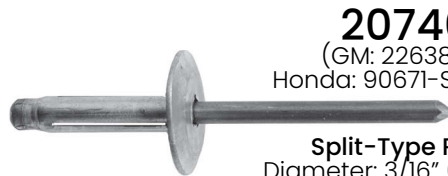

20740

(GM: 22638717;
Honda: 90671-SDA-A01)

Split-Type Rivet
 Diameter: 3/16" (4.8mm)
 Grip Range: 3/64" - 23/64" (1mm - 9mm)
 Flange Diameter: 5/8" (16mm)
 Aluminum Rivet & Mandrel
 Bumper Fascia & General Purpose
 GM 1987 - On
 Honda Civic 2016 - On

UNIT PACKAGE: 25



20741

(11516807;
Chry.; 6510520AA)

Split-Type Rivet
 Diameter: 3/16" (4.8mm)
 Grip: 3/64" - 23/64" (1mm-9mm)
 Flange Diameter: 5/8" (16mm)
 Aluminum Rivet (Black) & Aluminum Mandrel
 Bumper Fascia, Front Bumper & General Purpose
 GM 1990 - On,
 Chrysler 200 2017 - 2015; 300 2015 - On,
 Pacifica 2017 - On,
 Voyager & Jeep Gladiator 2020 - On,
 Dodge Challenger & Charger 2015 - On,
 Jeep Cherokee & Grand Cherokee 2014 - On,
 Compass 2013 - On, Wrangler 2019 - On

UNIT PACKAGE: 25

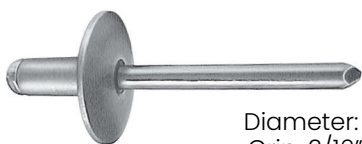

19460
(385974-S)

Diameter: 3/16"
Grip: 3/16"-1/4"
Flange Diameter: 5/8"
Aluminum Rivet & Steel Mandrel
General Purpose
Ford Econoline & Windstar 1995 - On

UNIT PACKAGE: 50



22264
(Ford:W714004-S900)

Liftgate, Exterior Trim & Quarter Panel Specialty Rivet
Diameter: 3/16" (4.8mm)
Grip Range: 3/16" - 3/8" (4.75mm - 9.53mm)
Flange Diameter: 7/16" (11mm)
Black Aluminum Rivet & Aluminum Mandrel
Ford Explorer & Flex 2009 - On

UNIT PACKAGE: 25



18168
(9433186)

Diameter: 3/16"
Grip 1/4"-3/8"
Flange Diameter: 5/8"
Steel Rivet (Zinc) & Steel Mandrel
Front & Rear Bumper
GM Saturn 1991 - On

UNIT PACKAGE: 50



12657
(9439719)

Diameter: 3/16"
Grip: 1/4"-3/8"
Flange Diameter: 5/8"
Steel Rivet (Black) & Steel Mandrel
Attaches Fascia to Underside Bumper
GM 1981 - On

UNIT PACKAGE: 50



24474
(ABA66L)
Black

Large Flange Rivet
Rivet Diameter: 3/16"
Flange Diameter: 5/8"
Grip Range: 1/4"-3/8"
Aluminum Rivet & Mandrel

UNIT PACKAGE: 50



16940

(GM: 2085119, 3533539, 3540161);
Not Supplied by Chrysler O.E.M.)

Diameter: 3/16"
Grip: 1/2" - 5/8"
Flange Diameter: 5/8"
Aluminum Rivet & Mandrel
Glass Stop/Roller Rivet
Chrysler
Front Bumper Fascia Lower Deflector
Cadillac 1993 - 87

UNIT PACKAGE: 25



17466
(N905150-S)

Diameter: 3/16"
Grip: 1/2"-5/8"
Flange Diameter: 5/8"
Aluminum Rivet & Steel Mandrel
Attaches License Plate Bracket
Ford

UNIT PACKAGE: 25



18935
(10160960)

Diameter: 3/16"
Grip: 1/2" - 25/32"
Flange Diameter: 5/8"
Aluminum Rivet & Steel Mandrel (Zinc)
Liftgate Strut Gate Side Bracket
Lumina APV, Silhouette & Trans Sport 1992 - On

UNIT PACKAGE: 25



17977
(Not Supplied by O.E.M.)

Diameter: 3/16"
Grip: 5/8"-3/4"
Flange Diameter: 5/8"
Aluminum Rivet & Mandrel
Glass Stop/Roller Rivet
Chrysler

UNIT PACKAGE: 25



1911
(N807168-S)

Diameter: 3/16"
Grip: 11/16"-13/16"
Flange Diameter: 3/4"
Aluminum Rivet & Mandrel
Grille & Bumper
Ford Windstar 1995 - On

UNIT PACKAGE: 25



22122

(Mercedes: 003-990-35-97)

Specialty Rivet
Diameter: 6.3mm (1/4")
Grip Range: 1.0mm - 8.5mm (.039" - .335")
Flange Diameter: 11mm (7/16")
Aluminum Rivet & Steel Mandrel
Mercedes 2012 - 1990

UNIT PACKAGE: 15



21124
(11610383)

Diameter: 1/4"
Grip: 1/64" - 1/8"
Flange Outer Diameter: 1/2"
Steel Rivet (Zinc) & Steel Mandrel
Step Bumper

GM Silverado & Sierra Pick-Ups 2007 - On

UNIT PACKAGE: 25



24447
(11610383)
Silver Zinc Plated

Blind Pin Grip Rivet
Rivet Diameter: 1/8"
Flange Diameter: 1/2"
Grip Range: 1/64"-1/8"
Steel Rivet & Mandrel
GM & Universal

UNIT PACKAGE: 25



22266
(GM: 11561334)
Zinc

Rear Compartment, Rocker & Wheelhouse Specialty Rivet

Diameter: 1/4" (6.3mm)
Grip Range: .059" - .138" (1.48mm - 3.50mm)
Flange Diameter: 1/2" (12.70mm)
Steel Rivet & Mandrel
Various GM Models, Cadillac CTS & SRX 2015 - 2009
Cadillac CT6 2016 - On

UNIT PACKAGE: 15

22067

(Ford: W707638-S900C)
Zinc

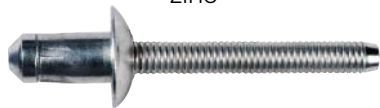

Cab, Rear Body, Floor, Door, Box, Wheel House & Back Panel Specialty Rivet

Diameter: 1/4" (6.3mm)
Grip: .060"-.138" (1.5mm - 3.5mm)
Flange Diameter: 1/2" (13mm)
Steel Rivet & Mandrel

Ford F-150 Trucks with Aluminum Body 2015 - On

UNIT PACKAGE: 10



18889
(22643056)
Yellow Zinc
Dichromate

Diameter: 1/4"
Grip: 1/16" - 5/32"
Flange Diameter: 1/2"
Steel Rivet & Mandrel
Door Window Regulator

Buick Skylark, Chevrolet Cavalier, Olds Achieva & Aurora, and Pontiac Grand Am & Sunfire 1995-On

UNIT PACKAGE: 25



21315
(90269-A0005,
90269-06017)

Diameter: 1/4" (6.3mm)
Grip: 1/16" - 3/16" (1.6mm - 4.8mm)
Flange Diameter: 1/2" (13mm)
Aluminum Rivet (Black) & Steel Mandrel
Fuel Door & General Purpose
Toyota and Lexus 2000 - On
Scion 2005 - On

UNIT PACKAGE: 10



18938
(2024778)
Zinc

Diameter: 1/4"
Grip: 1/8"-1/4"
Flange Diameter: 1/2"
Steel Rivet & Mandrel
Front Side Door Window Regulator
Chevrolet Lumina APV, Olds Silhouette & Pontiac Trans Sport 1990 - On

UNIT PACKAGE: 25

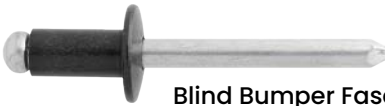

24576
(N808426-S100)

Blind Bumper Fascia Rivet

Rivet Diameter: 1/4"
Flange Diameter: 1/2"
Grip Range: 1/16"-1/4"
Aluminum Rivet
Ford

UNIT PACKAGE: 25

18810

(6033688)
Zinc



Diameter: 1/4"
Grip: 7/64"-3/16"
Flange Diameter: 1/2"
Steel Rivet & Mandrel
Glass & Frame Assembly and Floor Pan Reinforcement Attachment
Dodge Shadow, Plymouth Sundance & Jeep Cherokee 1991 - On

UNIT PACKAGE: 25

22023

(Ford: W702512-S900C)



Fender, Sill & Radiator Support Specialty Rivet

Diameter: 1/4" (6.3mm)
Grip: .110" - .189" (2.79mm - 4.8mm)
Flange Diameter: 1/2" (13mm)
Steel Rivet & Mandrel

Ford F-150 Trucks with Aluminum Body 2015

UNIT PACKAGE: 10

25108

(GM:19353809)
Zinc Finish



Inner Wheelhouse Blind Rivet

Diameter: 1/4" (6.3mm)
Grip: 0.132"-0.211" (3.35mm - 5.35mm)
Flange Diameter: 1/2" (13mm)
Steel Rivet & Mandrel

Buick Encore 2020 - On; Cadillac CT6 2016 - On;
Chevrolet Equinox 2018 - On

UNIT PACKAGE: 10

12654

(372820-S36, S40)



Diameter: 1/4"
Grip: 1/8"-1/4"

Flange Diameter: 1/2"

Steel Rivet (Zinc & Gold Chrome) & Steel Mandrel
Front Bumper Assembly
Ford 1979 - On

UNIT PACKAGE: 25

WARNING: Reproductive Harm & Cancer
www.P65Warnings.ca.gov

22265

(Mercedes: 000-991-59-32)



Front & Rear Door Specialty Rivet

Diameter: 6.3mm (1/4")
Grip Range: 3.5mm - 6.5mm (.138" - .265")
Flange Diameter: 16mm (5/8")
Aluminum Rivet & Steel Mandrel

Mercedes-Benz CLA & GLA Class 2014 - On

UNIT PACKAGE: 15

21286

(Ford: W708777-S900C;
Mercedes: 004-990-16-97)
Zinc



Specialty Rivet

Diameter: 1/4" (6.3mm)
Grip: 3/16" - 17/64" (4.80mm - 6.80mm)
Flange Diameter: 1/2" (13mm)
Steel Rivet & Mandrel

Cab, Radiator, Rail, Floor, Door, Pillar,
Cowl, Box & Back Panel
Ford F-150 Trucks with Aluminum Body 2015 - On
Mercedes Benz 2008 - On

UNIT PACKAGE: 10

22066

(Ford: W702554-S900C)
Zinc



Cab, Floor, Door, Pillar, Box & Cowl Specialty Rivet

Diameter: 1/4" (6.3mm)
Grip: .268" - .346" (6.8mm - 8.8mm)
Flange Diameter: 1/2" (13mm)
Steel Rivet & Mandrel
Ford F-150 Trucks with
Aluminum Body 2015 - On

UNIT PACKAGE: 10

25109

Zinc Finish



Blind Rivet

Diameter: 1/4" (6.3mm)
Grip: 0.295"-0.374" (7.5mm - 9.5mm)
Flange Diameter: 1/2" (13mm)
Steel Rivet & Mandrel
General Purpose

UNIT PACKAGE: 10

25110

Zinc Finish



Blind Rivet

Diameter: 1/4" (6.3mm)
Grip: 0.348"-0.425" (8.8mm - 10.8mm)
Flange Diameter: 1/2" (13mm)
Steel Rivet & Mandrel
General Purpose

UNIT PACKAGE: 10

25111

Zinc Finish



Blind Rivet

Diameter: 1/4" (6.3mm)
Grip: 0.425"-0.504" (10.8mm - 12.8mm)
Flange Diameter: 1/2" (13mm)
Steel Rivet & Mandrel
General Purpose

UNIT PACKAGE: 10



23939

(20375100)

Body Panel Blind Rivet

Diameter: 1/4"
Grip: .080-.375
Flange Diameter: 1/2"
Aluminum Rivet & Mandrel
GM Fiero, Various Body Locations

UNIT PACKAGE: 15

21245

(W705297-S300)



Split-Type Rivet
 Diameter: 1/4"
 Grip Range: 3/16" - 3/8"
 Flange Diameter: 11/16"
 Aluminum Rivet & Mandrel
 Bumper Cover
 Ford Fusion 2009 - On

UNIT PACKAGE: 15

21440

(Not Available from O.E.M.)



Closed End Rivet
 Diameter: 1/4"
 Grip Range: 1/4" - 3/8"
 Flange Diameter: 1/2"
 Aluminum Rivet & Steel Mandrel
 General Purpose

UNIT PACKAGE: 25

18170

(10204266)



Diameter: 1/4"
 Grip: 3/4"-1"
 Flange Diameter: 1/2"
 Aluminum Rivet & Mandrel
 Trunk Lock Cylinder
 Pontiac Firebird 1994 - On

UNIT PACKAGE: 10

19516

(N804851-S100)



Split-Type Rivet
 Diameter: 1/4"
 Grip: 3/64"-1/4"
 Flange Diameter: 9/16"
 Aluminum Rivet (Black) & Aluminum Mandrel
 Front Bumper
 Ford Taurus 1996 - On

UNIT PACKAGE: 15

17639

(Ford: N806830-S100;
 Chry: 6035201)



Split-Type Rivet
 Diameter: 1/4"
 Grip: 3/16"-3/8"
 Flange Diameter: 11/16"
 Aluminum Rivet & (Black) Aluminum Mandrel
 Attachment of Bumper Cover to Bumper &
 Front License Plate Bracket to Bumper Cover
 Ford, Lincoln 1992 - On
 Air Dam to Fascia, Wheel Arch Flare
 Chrysler, Dodge, Jeep 1993 - On

UNIT PACKAGE: 15

19263

Same as 17639 except for unit package quantity

UNIT PACKAGE: 25

12652

(388442-S100)



Diameter: 1/4"
 Grip: 1/8"-1/4"
 Flange Diameter: 3/4"
 Steel Rivet (Black) & Steel Mandrel
 Bumper Assembly
 Escort & Lynx 1981 - On

UNIT PACKAGE: 25

25179

(Tesla: 1063943-00-A)



Body Panel Blind Rivet
 Diameter: 6.5mm
 Grip: 2mm-4.5mm
 Flange Diameter: 13mm
 Steel Rivet & Mandrel

UNIT PACKAGE: 15

17421

(Tesla: 1028719-00-A)
 Photo not actual size



Ultra Grip Rivet
 Diameter: 3/16"
 Flange Diameter: 3/8"
 Grip Range: 1/16" - 17/64"
 Rivet Length: 13/32"
 Aluminum Rivet & Mandrel
 Tesla 3, S, X & Y

UNIT PACKAGE: 25

SELF-PIERCING RIVETS

For Aluminum Body Fastening



Self-piercing rivets (SPR) join two or more pieces of material using a rivet without a pre-drilled hole. Self-piercing rivets are a semi-tubular rivet driven at high force through the material layers to be joined, into a die which causes the tail of the rivet to flare out and form a joint.

The process requires no hole preparation and delivers high static strength similar to, or better than, spot welding. This process produces a fatigue resistant joint that is stronger than spot welding and less susceptible to corrosion.

The use of coated, lightweight and high-strength materials, such as galvanized or pre-painted steel and aluminum makes welding these materials difficult and often not possible.

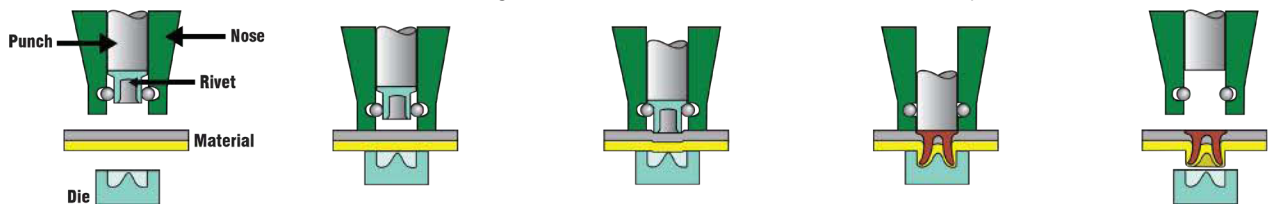

Auveco Part No.	Ford O.E.M. No.	Code**	F-150 Location	Overall Length*	Body Dia.*	I.D.	Head Dia.*	Head Style	Unit Pkg.
22876	W708713-S900	AS	Cab, Rocker Door, Cowel Back Panel	5.00mm	5.40mm	3.35mm	7.80mm	Solid	10
22877	W708714-S900	AT	Cab, Back Panel	6.05mm	5.30mm	3.35mm	7.80mm	Solid	10
22878	W708717-S900	AW	Door	8.05mm	5.30mm	3.20mm	7.80mm	Solid	10
22879	W710246-S900	BN/DB	Cab, Door, Cowl Back Panel	7.05mm	5.30mm	3.15mm	7.80mm	Solid	10
22880	W717182-S900	QC	Hinge Pillar	10.00mm	5.30mm	3.15mm	7.80mm	Hollow	10
22881	W717184-S900	QA	Door	9.05mm	5.30mm	3.15mm	7.80mm	Hollow	10
22882	W717185-S900	EL	Door, Hinge Pillar	9.05mm	5.30mm	3.20mm	7.80mm	Solid	10
22883	W717186-S900	EN	Cab, Door	8.05mm	5.30mm	3.15mm	7.80mm	Solid	10
22884	W717337-S900	PX	Door	7.55mm	5.30mm	3.20mm	7.80mm	Solid	10
25440	W718595-S900	SU	Cab Roof Panel	4.5mm	3.5mm	2.0mm	5.8mm	Solid	10

*Specs are approximate and for identification only

**Refer to Ford Service Kit instructions as to the proper SPR for your application

SELF-PIERCING RIVETS

For Aluminum & Steel Body Fastening

Self-Piercing Rivets for Aluminum & Steel Body Fastening

Self-piercing rivets (SPR) join two or more pieces of material using a rivet without a pre-drilled hole. Self-piercing rivets are a semi-tubular rivet driven at high force through the material layers to be joined, into a die which causes the tail of the rivet to flare out and form a joint.

The process requires no hole preparation and delivers high static strength similar to, or better than, spot welding.

This process produces a fatigue resistant joint that is stronger than spot welding and less susceptible to corrosion.

The use of coated, lightweight and high-strength materials, such as galvanized or pre-painted steel and aluminum makes welding these materials difficult and often not possible.

For general purpose use. Refer to application specifications when choosing the proper SPR.

- Material: Steel, H4 Hardness with patented Almac® Coating
- When using SPR rivets refer to the vehicle manufacturers (OEM) repair instructions. A test rivet should be set when the material or material thickness changes. These steps are the only way to obtain a reliable riveting process
- Used by many OE manufacturers

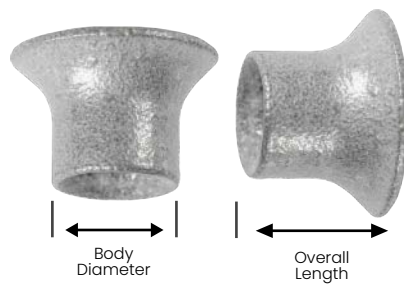

Auveco Part No.	Body Diameter	Overall Length	Unit Pkg.
25135	3.3mm	3.5mm	50
25136	3.3mm	4mm	50
25137	3.3mm	5mm	50
25138	3.3mm	6mm	50
25139	5.3mm	4mm	50
25140	5.3mm	5mm	50
25141	5.3mm	6mm	50
25142	5.3mm	6.5mm	50
25143	5.3mm	7mm	50
25144	5.3mm	7.5mm	50
25145	5.3mm	8mm	50
25146	5.3mm	9mm	50

Straight Shank 135° Split Point Black Finish



Auveco Part No.	Unit Pkg.	Size	Dec. Equiv.	Flute Length	Overall Length
13039	5	3/32"	.0938	1-1/4"	2-1/4"
13040	5	7/64"	.1094	1-1/2"	2-5/8"
13041	5	1/8"	.1250	1-5/8"	2-3/4"
13042	5	9/64"	.1406	1-3/4"	2-7/8"
13043	5	5/32"	.1562	2"	3-1/8"
13044	5	11/64"	.1719	2-1/8"	3-1/4"
13045	5	3/16"	.1875	2-5/16"	3-1/2"
13046	5	13/64"	.2031	2-7/16"	3-5/8"
13047	5	7/32"	.2188	2-1/2"	3-3/4"
13048	5	15/64"	.2344	2-5/8"	3-7/8"
13049	5	1/4"	.2500	2-3/4"	4"
13050	5	17/64"	.2656	2-7/8"	4-1/8"
13051	5	9/32"	.2812	2-15/16"	4-1/4"
13052	5	19/64"	.2969	3-1/16"	4-3/8"
13053	5	5/16"	.3125	3-3/16"	4-1/2"
13054	5	21/64"	.3281	3-5/16"	4-5/8"
13055	5	11/32"	.3438	3-7/16"	4-3/4"
13056	5	23/64"	.3594	3-1/2"	4-7/8"
13057	5	3/8"	.3750	3-5/8"	5"
13058	5	25/64"	.3906	3-3/4"	5-1/8"
13059	5	13/32"	.4062	3-7/8"	5-1/4"
13060	5	27/64"	.4219	3-15/16"	5-3/8"
13061	5	7/16"	.4375	4-1/16"	5-1/2"
13062	5	29/64"	.4531	4-3/16"	5-5/8"
13063	5	15/32"	.4688	4-5/16"	5-3/4"
13064	5	31/64"	.4844	4-3/8"	5-7/8"
13065	3	1/2"	.5000	4-1/2"	6"

Cobalt Steel Spot Weld Drills



Auveco Part No.	Unit Pkg.	Size	Flute Length	Overall Length
22604	3	6.5mm (1/4")	27mm (1-1/16")	58mm (2-1/4")
20479	3	8mm (5/16")	27mm (1-1/16")	58mm (2-1/4")
20480	3 (3/8")	10mm (1-1/16")	27mm (2-1/4")	58mm

Carbide Spot Weld Drill Bits for Boron Steel



Auveco Part No.	Unit Pkg.	Size	Flute Length	Overall Length
22605	1	6.5mm (5/16")	0.0750"	1.75"
22606	1	6.5mm (5/16")		2.00"

High Speed Jobber Length Drill Set Metal Drill Indexes



13136

Jobbers Length Straight Shank
135° Split Point
Sizes 1/16" thru 1/2" by 64th
29 Pieces

UNIT PACKAGE: 1 Set

22609

Size Ranges: 1/16" to 1/2" by
64ths
No. of Pieces: 29

UNIT PACKAGE: 1



Metric Jobber Length Drill Bits



- 135° split point provides fast penetration and accurate starting without center punch
- Withstands substantially higher drilling temperatures while maintaining sharpness
- Recommended use for work hardening grades of stainless steel and other hard metals
 - Manufactured to NAS 907B aerospace specification
 - Straight Shank

Auveco Part No.	Diameter MM	Flute Length		Overall Length		Unit Pkg.
		MM	Inches	MM	Inches	
22610	1.0	17	11/16"	41	1-5/8"	2
22611	1.5	22	7/8"	48	1-7/8"	2
22612	2.0	25	1"	51	2"	2
22613	2.5	35	1-3/8"	60	2-23/64"	2
22614	3.0	41	1-5/8"	70	2-3/4"	2
22615	3.5	45	1-3/4"	73	2-7/8"	2
22616	4.0	54	2-1/8"	83	3-1/4"	2
22617	4.2	54	2-1/8"	83	3-1/4"	2
22618	4.5	56	2-13/64"	86	3-3/8"	2
22619	5.0	62	2-7/16"	92	3-5/8"	2
22620	5.5	64	2-1/2"	95	3-3/4"	2
22621	6.0	70	2-3/4"	102	4"	2
22622	6.5	73	2-7/8"	105	4-1/8"	2
22623	6.7	73	2-7/8"	105	4-1/8"	2
22624	7.0	73	2-7/8"	105	4-1/8"	2
22625	7.5	78	3"	111	4-3/8"	1
22626	8.0	81	3-3/16"	114	4-1/2"	1
22627	8.5	87	3-27/64"	121	4-3/4"	1
22628	9.0	89	3-1/2"	124	4-7/8"	1
22629	9.5	92	3-5/8"	127	5"	1
22630	10.0	95	3-3/4"	130	5-1/8"	1
22631	10.5	98	3-7/8"	133	5-15/64"	1
22632	11.0	103	4-1/16"	140	5-1/2"	1
22633	11.5	106	4-7/32"	143	5-5/8"	1
22634	12.0	111	4-3/8"	149	5-7/8"	1
22635	12.5	114	4-1/2"	152	6"	1
22636	13.0	114	4-1/2"	152	6"	1

Metric Jobber Length Drill Bit

22637



Size Ranges: 1.0mm - 13.0mm by .5mm
No. of Pieces: 25

UNIT PACKAGE: 1

Screw Machine Length Drills

135° Split Point

Straight Shank • Black Finish



Auveco Part No.	Unit Pkg.	Size	Dec. Equiv.	Flute Length	Overall Length
13120	5	1/16"	.0625	5/8"	1-5/8"
13121	5	5/64"	.0781	11/16"	1-11/16"
13124*	5	1/8"	.1250	7/8"	1-7/8"
13128	5	3/16"	.1875	1-1/8"	2-3/16"
13132	5	1/4"	.2500	1-3/8"	2-1/2"
13133	5	5/16"	.3125	1-5/8"	2-13/16"
13134	2	3/8"	.3750	1-13/16"	3-1/8"

* For 1/8" Pop Rivets

Double-End Drill Bits



Auveco Part No.	Unit Pkg.	Size	Flute Length	Overall Length
12676	5	1/8" (.1250)	1/2"	2"
22607	5	3/16" (.1875)	1/2"	2-1/4"
22608	5	1/4" (.250)	1/2"	2-2/12"
24588	12	7/64" (0.1094)		2"

Step Drills

- Multiple diameters with one drill bit
- Gold Oxide with 3 flats on the shank
- Special Axial and Radial flute design increases penetration
- Dual flute drills clean and accurate holes in thin materials quickly and easily

22638



Industry No.: 1
 No. of Hole Sizes: 13
 No. Range: 1/8" - 1/2"
 Shank Size: 1/4"
 Step Increments: 1/32"
 Step Thickness: 1/8"

UNIT PACKAGE: 1

22639



Industry No.: 2
 No. of Hole Sizes: 8
 No. Range: 1/4" - 1"
 Shank Size: 3/8"
 Step Increments: 1/16"
 Step Thickness: 5/32"

UNIT PACKAGE: 1

22640



Industry No.: 3
 No. of Hole Sizes: 9
 No. Range: 1/4" - 3/4"
 Shank Size: 3/8"
 Step Increments: 1/16"
 Step Thickness: 5/32"

UNIT PACKAGE: 1

Aluminum Oxide Resin Bonded Cut-Off Wheels

Designed for steel cutting use only.
 Never use these wheels for any other applications.
 Never use on Fiberglass!



Auveco Part No.		Diameter	Thickness	Arbor	Grit	RPM
Unit Pkg. 10	Unit Pkg. 25					
19688	19687	3"	1/16"	3/8"	54	25,000
19690	19689	3"	1/32"	3/8"	54	25,000
19692	19691	3"	1/16"	1/4"	54	25,000
19694	19693	3"	1/32"	1/4"	54	25,000
19698	19697	3"	1/8"	3/8"	46	25,000
19702	19701	4"	1/32"	3/8"	60	21,000
19706	19705	4"	1/16"	3/8"	54	21,000

General Purpose Depressed Center Wheels TYPE 27 • Standard Shape

The most popular Raised Hub wheel for grinding and blending

CAUTION!

- Never use a wheel that has been dropped
- Always wear full face protection when grinding
- Use a guard covering 50% or more of wheel diameter



Auveco Part No.		Diameter	Thickness	Arbor	Grit	RPM
Unit Pkg. 10	Unit Pkg. 25					
19712	19711	4"	1/4"	5/8"	36	13,700
19714	19713	4-1/2"	1/4"	7/8"	24	11,900

Cut-Off Wheel Mandrels Arbors for Air Grinders



19715

Zinc

Mandrel with
3/8" Shoulder Screw

UNIT PACKAGE: 1



19716

Zinc

Mandrel with
1/4" & 3/8" Shoulder Screws

UNIT PACKAGE: 1

Abrasive Flap Discs

Flap discs use diagonal layers of sandpaper on a resin fiber backing. Flaps are glued onto a multi-layer fiberglass or plastic backing plate. New grit is continuously being exposed as the flaps wear down providing consistent performance throughout the life of the disc. The design of flap discs allows them to run cooler reducing warping of thin metals such as body panels.

Type 29 (Beveled) Flap Discs

- Grind and finish at the same time
- Conical flap discs (Type 29) are angled and designed to be used on contoured and edge work
- The angle provides greater surface contact for stock removal on flat surfaces
- Discs cut cleaner, faster and cooler reducing clogging and glazing
- Longer lasting than conventional fiber-backed abrasive discs
- For use on flat or curved surfaces
- Quieter than grinding discs
- For use on portable right-angle grinders
- Suitable for use on a wide variety of materials as well as all types of steel, including stainless steel

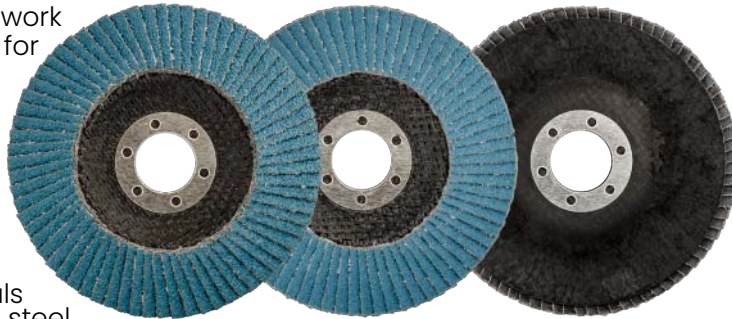

Auveco Part No.	Size	Grit	Arbor	Max. RPM	Grain	Unit Pkg.
22647	4.5"	40	7/8"	13,300	Zirconia	1
22648	4.5"	60	7/8"	13,300	Zirconia	1
22649	4.5"	80	7/8"	13,300	Zirconia	1

Type 27 Mini Flap Discs

- Perfect for small grinding needs and tight spots
- Works on all high-speed grinders
- Flat Face (Type 27) for maximum aggressiveness
- Uses 100% of the grain surface
- Grind, deburr and blend on all surfaces
- Non-loading and never curl
- Twist-to-lock backing, use with holders 22389 and 22390



Auveco Part No.	Size	Grit	Max. RPM	Grain	Unit Pkg.
22641	2"	40	30,000	Zirconia	3
22642	2"	60	30,000	Zirconia	3
22643	2"	80	30,000	Zirconia	3
22644	3"	40	20,000	Zirconia	2
22645	3"	60	20,000	Zirconia	2
22646	3"	80	20,000	Zirconia	2

Mini Sanding Belts

Zirconia grain with durable poly/cotton backing



Photos not actual size



- Designed to be used on any Mini Belt Sander that is either 3/8" x 13" or 1/2" x 18" in size
- Long life Zirconia grain, outlasts & performs better on aluminum than aluminum oxide
- Applications include seam sealer removal, sanding of self-piercing rivets, prepping surfaces and metal working

Auveco Part No.	Size	Grit	Unit Pkg.
22650	3/8" x 13"	40	10
22651	3/8" x 13"	60	10
22652	3/8" x 13"	80	10
22653	3/8" x 13"	120	10
22654	1/2" x 18"	40	10
22655	1/2" x 18"	60	10
22656	1/2" x 18"	80	10
22657	1/2" x 18"	120	10

Mini Grinding Discs



- Premium blue Zirconia grain bonded onto a tough resin backing
- Long-life on regular steels & stainless steels
- Best for weld grinding and finishing
- Fast & easy to change twist-to-lock mounting

Auveco Part No.	Size	Grit	RPM	Unit Pkg.
22381	2"	24	25,000	25
22382	2"	36	25,000	25
22383	2"	50	25,000	25
22384	2"	80	25,000	25
22385	3"	24	20,000	25
22386	3"	36	20,000	25
22387	3"	50	20,000	25
22388	3"	80	20,000	25

Surface Conditioning Discs



- Non-woven nylon fiber embedded with aluminum oxide abrasive grain
- For general grinding, blending, rust removal, clean-up and paint removal
- Thicker, longer lasting material
- Fast & easy to change twist-to-lock mounting

Auveco Part No.	Size	Grade	Color	RPM	Unit Pkg.
22374	2"	Coarse	Brown	25,000	25
22375	2"	Medium	Maroon	25,000	25
22376	2"	Fine	Blue	25,000	25
22377	3"	Coarse	Brown	20,000	25
22378	3"	Medium	Maroon	20,000	25

Twist-to-Lock Holders

- For use with mini grinding, surface conditioning & strip-brite discs
- 1/4" Shank



22389

For 2" Discs

UNIT PACKAGE: 1



22390

For 3" Discs

UNIT PACKAGE: 1

WARNING: ALL ITEMS ON PAGE Cancer www.P65Warnings.ca.gov

Hand Sanding Pads

- Non-woven pads impregnated with resin and grain for a variety of applications
- Best for hand sanding parts, removing rust & cleaning/prepping surfaces



22379

Gray

Width: 6"
Length: 9"
Grit: Ultra Fine

UNIT PACKAGE:
1 (set of 10)



22380

Maroon

Width: 6"
Length: 9"
Grit: Medium

UNIT PACKAGE:
1 (set of 10)

Strip-Brite Discs

- For paint and coating removal
- Fast and easy to change twist-to-lock mounting
- Open-web construction impregnated with silicon carbide to provide aggressive and long-lasting performance
- Extremely durable, three-dimensional web has a soft edge, allowing it to remove paint and other coatings in those difficult & unreachable creases & dents while removing very little metal.
- Great for stripping paint without damaging the metal, especially on aluminum.

22658

Purple



Size: 2"

UNIT PACKAGE: 1



22391

Purple

Size: 3"

UNIT PACKAGE: 1

WARNING: ALL ITEMS ON PAGE Cancer www.P65Warnings.ca.gov



Photo not actual size

- Quick and easy removal of decals, pinstripes, bumper stickers, reflective tapes etc. from glass, urethane, acrylic paints and OEM painted surfaces
- Effectively removes adhesive tapes and glue from the back of mouldings
- Longer lasting and wider than a solid disc for faster job completion
- Toothed wheel works cooler causing less smearing
- Universal arbor for use with electric or pneumatic tools
- **Best results at 1,500 - 3,000 RPM. Max. 4,000 RPM**

Application

Clean the surface thoroughly. Apply light pressure only. Start at the top of the decal and move side to side. For faster results use the entire width of the wheel, do not tilt on an angle.

Auveco Part No.	Size	Arbor Size	Max. RPM	Unit Pkg.
22659	4" dia x 1" width	1/4"	4,000	1

Warning: Cancer - www.P65Warnings.ca.gov

AuvecoPak AP448 Retail Merchandiser

AuvecoPak part numbers are the same as standard Auveco part numbers with an "AP" prefix. Thus AP11146 is the AuvecoPak version of 11146.

AP448 includes two packages of each part number, for a total of 896 packages

WARNING: Reproductive Harm & Cancer www.P65Warnings.ca.gov



The AuvecoPak AP448 merchandiser provides 448 of the fastest moving, most popular automotive body hardware and specialty fasteners.

Each of the 7 panels contain 32 part numbers per side.

Set-up is easy with panels "pre-dressed" with the AuvecoPaks already in place. Simply position the top and bottom brackets on a gondola or pegboard wall. Insert the panels into the brackets.

An individual panel measures 6-1/2" (wide) x 17-1/2" (front to back) x 44-1/2" (high). The merchandiser fits onto a gondola with 48" x 48" of pegboard or on any pegboard wall.

AuvecoPak packages feature, contemporary graphics with all the necessary application and descriptive information in trilingual verbiage (English, Spanish and French-Canadian).

AuvecoPak part numbers are the same as standard Auveco part numbers with an "AP" prefix. Thus AP11146 is the AuvecoPak version of 11146.

Reordering is a breeze, the AuvecoPak part number and UPC-A bar code are on the panel back-up boards beneath each hook. Restocking is also quick and easy with the AuvecoPak packages' locator codes identifying their specific location on the panels.

A gondola is not included with the AP448 Auveco customer service reps can recommend a source for gondolas.



An AuvecoPak "Product Identification Guide" is provided with each merchandiser. The guide features actual size photos of all of the parts, along with complete descriptions, size dimensions and application information, as well as, each item's location (panel, row and position) on the merchandiser.

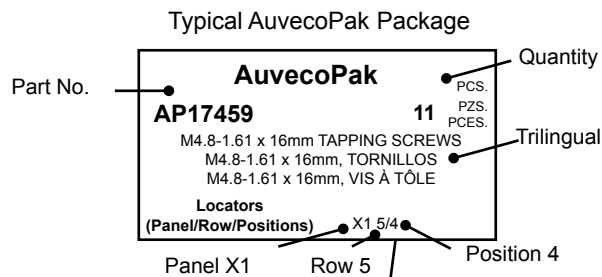

AuvecoPak AP448 Retail Merchandiser Contents

AuvecoPak part numbers are the same as standard Auveco part numbers with an "AP" prefix. Thus API1146 is the AuvecoPak version of 11146. *Photos not actual size.*



Panel T1

Retainers

Row 1	API0832	API0831	API1146	API7664
Row 2	AP20192	API1120	API4921	API4021
Row 3	API11612	API11721	API5367	API7612
Row 4	API11679	API9837	API6818	API2731
Row 5	API8301	API4032	API4036	API2766
Row 6	API5543	AP20366	AP20316	API1351
Row 7	AP20530	API2137	API5481	API5480
Row 8	API2571	API2909	API5479	AP21658



Panel T2

Retainers & Trim Panel Fasteners

Row 1	API5457	API2759	API5456	API1130
Row 2	API7649	API2565	API3470	API8848
Row 3	API11671	API5970	API2992	API9386
Row 4	API8915	API1797	API8930	API7075
Row 5	API9270	API6695	API5461	API1678
Row 6	AP20616	API3461	API0621	API2737
Row 7	API1796	AP20360	API1863	AP2310
Row 8	AP2309	AP21187	API9682	API8114



Panel U1

Retaining Clips & Retainers

Row 1	API9114	AP20953	AP20164	AP22439
Row 2	API4355	API4291	API8297	AP22994
Row 3	API4737	AP21588	AP21420	API7975
Row 4	API9655	AP21334	API7004	API4163
Row 5	API7339	API9171	API8877	API8033
Row 6	API4328	API0744	AP20991	AP20990
Row 7	AP20988	AP22039	AP21192	AP20989
Row 8	AP20880	AP21173	AP21706	API8353



Panel U2

Push-Type Retainers

Row 1	API2567	API4011	API4010	API2757
Row 2	AP20335	AP20869	AP20908	AP20349
Row 3	API9239	API9118	AP20955	API8888
Row 4	API9274	AP20247	AP20986	API9453
Row 5	API9233	API9246	AP20327	AP20564
Row 6	API9801	API9639	API7222	AP20888
Row 7	API7103	API6622	API3996	API3993
Row 8	AP20931	AP20458	API9615	AP2088



Panel V1

Push-Type Retainers

Row 1	API8873	AP20632	API9422	API7216
Row 2	API3994	API5044	API4019	API4020
Row 3	API5042	API4696	API4697	API4260
Row 4	API7379	API6000	API7632	API7267
Row 5	API4997	API6858	AP20348	AP21201
Row 6	API4992	API4753	API7472	API7057
Row 7	API9140	API9739	API7143	API6835
Row 8	API8119	API4994	API7144	API9613



Panel V2

Rivets

Row 1	API3748	API3755	API4023	API8108
Row 2	API3751	API3750	AP20754	API3752
Row 3	API3753	AP20788	AP20627	API2658
Row 4	API6834	API7615	API7006	API8461
Row 5	AP20629	AP22088	API6864	API7121
Row 6	AP22481	AP20741	API4127	API2652
Row 7	API7639	AP22067	AP8925	AP21315
Row 8	AP20971	AP8311	AP8301	AP8313



Panel W1

Rivets, Specialty Nuts, & Nylon Nuts

Row 1	API11620	API11621	API2655	API2653
Row 2	API18167	API3007	P13009	API3008
Row 3	API3004	API3010	API6253	API6251
Row 4	API3014	API3016	API3017	API3232
Row 5	API5326	API2595	API5335	API18153
Row 6	API11855	AP9829	API0330	API11691
Row 7	AP9862	API3450	API3960	API3933
Row 8	API3932	API4274	API4313	AP3682



Panel W2

Nylon Nuts, Screw Grommets, Thread Cutting Nuts, Push-On Retainers & Pushnut Bolt Retainers

Row 1	API11719	AP8435	API4695	AP20954
Row 2	API9194	API9756	AP20440	API9721
Row 3	API4267	API9614	P12255	API5711
Row 4	AP3403	AP2895	AP8855	AP3404
Row 5	AP2896	AP2897	AP3405	API0733
Row 6	AP2557	AP8863	AP8864	AP8865
Row 7	AP8868	AP8869	API0374	API0086
Row 8	API0087	AP9297	AP9299	API2127

AuvecoPak AP448 Retail Merchandiser Contents

AuvecoPak part numbers are the same as standard Auveco part numbers with an "AP" prefix. Thus API1146 is the AuvecoPak version of 11146. Photos not actual size.



Panel X1
Black Tapping Screws

Row 1	API2213	API2214	API2215	API2216
Row 2	API2217	API2218	API2953	API2954
Row 3	API2957	API1788	API1789	API1791
Row 4	API1792	API5774	API3026	API7650
Row 5	API2820	AP22070	API8340	API7459
Row 6	AP20259	AP20455	AP21081	API0165
Row 7	API0167	AP22348	API0182	API9278
Row 8	AP22550	API2742	API5775	API5373



Panel X2
License Plate Screws, Body Bolts & Zinc/Chrome Tapping Screws

Row 1	API8354	API6421	API2351	API2339
Row 2	API0823	AP9480	API0362	API1320
Row 3	AP5711	API1109	API1110	API2324
Row 4	API2693	API2067	API2160	API2065
Row 5	API2066	API8769	API3613	API2348
Row 6	API3614	API0642	AP2805	API2095
Row 7	API1456	API5172	AP2806	AP20446
Row 8	AP2710	API799	AP2713	AP20680



Panel Y1
License Plate Screws, Zinc/Chrome Tapping Screws & Body Bolts, Bumper Bolts & Headlight Adjusting Screws

Row 1	API717	AP2730	AP2775	AP2771
Row 2	AP2751	AP2772	AP2773	AP3466
Row 3	AP3467	API7098	API7980	API9777
Row 4	API1369	AP9603	API6960	API4473
Row 5	API7315	API7316	API6826	API5170
Row 6	API7034	API2335	AP9615	API1914
Row 7	AP8443	AP9355	AP3099	AP3102
Row 8	AP3178	API1655	API1826	API1243



Panel Y2
Moulding Clips, Clips & Fasteners and Door Hinge Pins & Bushings

Row 1	AP2744	API9626	AP2619	AP2752
Row 2	API9807	API9378	AP22846	API5695
Row 3	AP20687	AP20390	AP20391	AP20688
Row 4	API4642	API1152	AP22099	AP22124
Row 5	AP20607	AP20774	AP20328	AP20377
Row 6	API9822	AP21374	AP8941	API1067
Row 7	AP9633	AP21136	AP22167	AP22874
Row 8	AP20268	AP22272	AP22818	AP22289



Panel Z1
Extruded U-Nuts, Cage Nuts, Spring Type U-Nuts, Fender & Bumper Cover Nut and Retainer

Row 1	API0048	API5677	AP8359	API0051
Row 2	API0053	AP8814	API0054	API0055
Row 3	API1625	API1626	API6846	API2669
Row 4	API6842	API6322	API2575	API1628
Row 5	API1629	API1630	API1631	AP21040
Row 6	AP5586	AP5589	AP5170	AP20758
Row 7	API0064	API0065	AP9880	AP20757
Row 8	AP9879	API0066	API5752	API0067



Panel Z2
U-Nuts, Flat Nuts, Tubular Nuts, Cable Straps, Wire Loom Clips, Rubber Bumpers, Sheet Metal Plugs, Vacuum Caps, Shims & Miscellaneous

Row 1	API0666	API3225	API1292	AP5197
Row 2	AP2293	AP2099	AP21027	API903
Row 3	AP2611	AP2595	AP21754	API0073
Row 4	AP2288	AP21792	API4298	AP20380
Row 5	API4546	API4547	AP22100	AP22253
Row 6	API1746	AP4233	AP4188	AP21016
Row 7	API2210	AP4440	AP4439	AP2453
Row 8	AP5076	AP5077	AP3155	AP3156

AuvecoPak AP448

Retail Merchandiser Contents

Part No.	Location	Part No.	Location
AP1717	Panel Y1 Row 1 Position 1	AP8435	Panel W2 Row 1 Position 2
AP1799	Panel X2 Row 8 Position 2	AP8443	Panel Y1 Row 7 Position 1
AP1903	Panel Z2 Row 2 Position 4	AP8814	Panel Z1 Row 2 Position 2
AP2099	Panel Z2 Row 2 Position 2	AP8855	Panel W2 Row 4 Position 3
AP2288	Panel Z2 Row 4 Position 1	AP8863	Panel W2 Row 6 Position 2
AP2293	Panel Z2 Row 2 Position 1	AP8864	Panel W2 Row 6 Position 3
AP2309	Panel T2 Row 8 Position	AP8865	Panel W2 Row 6 Position 4
AP2310	Panel T2 Row 7 Position 4	AP8868	Panel W2 Row 7 Position 1
AP2453	Panel Z2 Row 7 Position 4	AP8869	Panel W2 Row 7 Position 2
AP2557	Panel W2 Row 6 Position 1	AP8925	Panel V2 Row 7 Position 3
AP2595	Panel Z2 Row 3 Position 2	AP8941	Panel Y2 Row 6 Position 3
AP2611	Panel Z2 Row 3 Position 1	AP9297	Panel W2 Row 8 Position 2
AP2619	Panel Y2 Row 1 Position 3	AP9299	Panel W2 Row 8 Position 3
AP2710	Panel X2 Row 8 Position 1	AP9355	Panel Y1 Row 7 Position 2
AP2713	Panel X2 Row 8 Position 3	AP9480	Panel X2 Row 2 Position 2
AP2730	Panel Y1 Row 1 Position 2	AP9603	Panel Y1 Row 4 Position 2
AP2744	Panel Y2 Row 1 Position 1	AP9615	Panel Y1 Row 6 Position 3
AP2751	Panel Y1 Row 2 Position 1	AP9633	Panel Y2 Row 7 Position 1
AP2752	Panel Y2 Row 1 Position 4	AP9829	Panel W1 Row 6 Position 2
AP2771	Panel Y1 Row 1 Position 4	AP9862	Panel W1 Row 7 Position 1
AP2772	Panel Y1 Row 2 Position 2	AP9879	Panel Z1 Row 8 Position 1
AP2773	Panel Y1 Row 2 Position 3	AP9880	Panel Z1 Row 7 Position 3
AP2775	Panel Y1 Row 1 Position 3	API0048	Panel Z1 Row 1 Position 1
AP2805	Panel X2 Row 6 Position 3	API0051	Panel Z1 Row 1 Position 4
AP2806	Panel X2 Row 7 Position 3	API0053	Panel Z1 Row 2 Position 1
AP2895	Panel W2 Row 4 Position 2	API0054	Panel Z1 Row 2 Position 3
AP2896	Panel W2 Row 5 Position 1	API0055	Panel Z1 Row 2 Position 4
AP2897	Panel W2 Row 5 Position 2	API0064	Panel Z1 Row 7 Position 1
AP3099	Panel Y1 Row 7 Position 3	API0065	Panel Z1 Row 7 Position 2
AP3102	Panel Y1 Row 7 Position 4	API0066	Panel Z1 Row 8 Position 2
AP3155	Panel Z2 Row 8 Position 3	API0067	Panel Z1 Row 8 Position 4
AP3156	Panel Z2 Row 8 Position 4	API0073	Panel Z2 Row 3 Position 4
AP3403	Panel W2 Row 4 Position 1	API0086	Panel W2 Row 7 Position 4
AP3404	Panel W2 Row 4 Position 4	API0087	Panel W2 Row 8 Position 1
AP3405	Panel W2 Row 5 Position 3	API0165	Panel X1 Row 6 Position 4
AP3466	Panel Y1 Row 2 Position 4	API0167	Panel X1 Row 7 Position 1
AP3467	Panel Y1 Row 3 Position 1	API0182	Panel X1 Row 7 Position 3
AP3682	Panel W1 Row 8 Position 4	API0330	Panel W1 Row 6 Position 3
AP4188	Panel Z2 Row 6 Position 3	API0362	Panel X2 Row 2 Position 3
AP4233	Panel Z2 Row 6 Position 2	API0374	Panel W2 Row 7 Position 3
AP4439	Panel Z2 Row 7 Position 3	API0621	Panel T2 Row 6 Position
AP4440	Panel Z2 Row 7 Position 2	API0642	Panel X2 Row 6 Position 2
AP5076	Panel Z2 Row 8 Position 1	API0666	Panel Z2 Row 1 Position 1
AP5077	Panel Z2 Row 8 Position 2	API0733	Panel W2 Row 5 Position 4
AP5170	Panel Z1 Row 6 Position 3	API0744	Panel U1 Row 6 Position 2
AP5197	Panel Z2 Row 1 Position 4	API0823	Panel X2 Row 2 Position 1
AP5586	Panel Z1 Row 6 Position 1	API0831	Panel T1 Row 1 Position 2
AP5589	Panel Z1 Row 6 Position 2	API0832	Panel T1 Row 1 Position 1
AP5711	Panel X2 Row 3 Position 1	API1067	Panel Y2 Row 6 Position 4
AP8301	Panel V2 Row 8 Position 3	API1109	Panel X2 Row 3 Position 2
AP8311	Panel V2 Row 8 Position 2	API1110	Panel X2 Row 3 Position 3
AP8313	Panel V2 Row 8 Position 4	API1120	Panel T1 Row 2 Position 2
AP8359	Panel Z1 Row 1 Position 3	API1130	Panel T2 Row 1 Position 4

Part No.	Location	Part No.	Location
API1146	Panel T1 Row 1 Position 3	API2348	Panel X2 Row 5 Position 4
API1152	Panel Y2 Row 4 Position 2	API2351	Panel X2 Row 1 Position 3
API1243	Panel Y1 Row 8 Position 4	API2565	Panel T2 Row 2 Position 2
API1292	Panel Z2 Row 1 Position 3	API2567	Panel U2 Row 1 Position 1
API1320	Panel X2 Row 2 Position 4	API2571	Panel T1 Row 8 Position 1
API1351	Panel T1 Row 6 Position 4	API2575	Panel Z1 Row 4 Position 3
API1369	Panel Y1 Row 4 Position 1	API2595	Panel W1 Row 5 Position 2
API1456	Panel X2 Row 7 Position 1	API2652	Panel V2 Row 6 Position 4
API1612	Panel T1 Row 3 Position 1	API2653	Panel W1 Row 1 Position 4
API1620	Panel W1 Row 1 Position 1	API2655	Panel W1 Row 1 Position 3
API1621	Panel W1 Row 1 Position 2	API2669	Panel Z1 Row 3 Position 4
API1626	Panel Z1 Row 3 Position 2	API2693	Panel X2 Row 4 Position
API1628	Panel Z1 Row 4 Position 4	API2731	Panel T1 Row 4 Position 4
API1629	Panel Z1 Row 5 Position 1	API2737	Panel T2 Row 6 Position 4
API1630	Panel Z1 Row 5 Position 2	API2742	Panel X1 Row 8 Position 2
API1631	Panel Z1 Row 5 Position 3	API2757	Panel U2 Row 1 Position 4
API1633	Panel X2 Row 5 Position 2	API2759	Panel T2 Row 1 Position 2
API1655	Panel Y1 Row 8 Position 2	API2766	Panel T1 Row 5 Position 4
API1671	Panel T2 Row 3 Position 1	API2820	Panel X1 Row 5 Position 1
API1678	Panel T2 Row 5 Position 4	API2909	Panel T1 Row 8 Position 2
API1679	Panel T1 Row 4 Position 1	API2953	Panel X1 Row 2 Position 3
API1691	Panel W1 Row 6 Position 4	API2954	Panel X1 Row 2 Position 4
API1719	Panel W2 Row 1 Position 1	API2957	Panel X1 Row 3 Position 1
API1721	Panel T1 Row 3 Position 2	API2992	Panel T2 Row 3 Position 3
API1746	Panel Z2 Row 6 Position 1	API3004	Panel W1 Row 3 Position 1
API1788	Panel X1 Row 3 Position 2	API3007	Panel W1 Row 2 Position 2
API1789	Panel X1 Row 3 Position 3	API3008	Panel W1 Row 2 Position 4
API1791	Panel X1 Row 3 Position 4	API3009	Panel W1 Row 2 Position 3
API1792	Panel X1 Row 4 Position 1	API3010	Panel W1 Row 3 Position 2
API1796	Panel T2 Row 7 Position 1	API3014	Panel W1 Row 4 Position 1
API1797	Panel T2 Row 4 Position 2	API3016	Panel W1 Row 4 Position 2
API1826	Panel Y1 Row 8 Position 3	API3017	Panel W1 Row 4 Position 3
API1863	Panel T2 Row 7 Position 3	API3026	Panel X1 Row 4 Position 3
API1864	Panel Z1 Row 3 Position 1	API3225	Panel Z2 Row 1 Position 2
API1914	Panel Y1 Row 6 Position 4	API3232	Panel W1 Row 4 Position 4
API2065	Panel X2 Row 4 Position 4	API3450	Panel W1 Row 7 Position 2
API2066	Panel X2 Row 5 Position 1	API3461	Panel T2 Row 6 Position 2
API2067	Panel X2 Row 4 Position 2	API3470	Panel T2 Row 2 Position 3
API2095	Panel X2 Row 6 Position 4	API3613	Panel X2 Row 5 Position 3
API2127	Panel W2 Row 8 Position 4	API3614	Panel X2 Row 6 Position 1
API2137	Panel T1 Row 7 Position 2	API3748	Panel V2 Row 1 Position 1
API2160	Panel X2 Row 4 Position 3	API3750	Panel V2 Row 2 Position 2
API2210	Panel Z2 Row 7 Position 1	API3751	Panel V2 Row 2 Position 1
API2213	Panel X1 Row 1 Position 1	API3752	Panel V2 Row 2 Position 4
API2214	Panel X1 Row 1 Position 2	API3753	Panel V2 Row 3 Position 1
API2215	Panel X1 Row 1 Position 3	API3755	Panel V2 Row 1 Position 2
API2216	Panel X1 Row 1 Position 4	API3932	Panel W1 Row 8 Position 1
API2217	Panel X1 Row 2 Position 1	API3933	Panel W1 Row 7 Position 4
API2218	Panel X1 Row 2 Position 2	API3960	Panel W1 Row 7 Position 3
API2255	Panel W2 Row 3 Position 3	API3993	Panel U2 Row 7 Position 4
API2324	Panel X2 Row 3 Position 4	API3994	Panel V1 Row 2 Position 1
API2335	Panel Y1 Row 6 Position 2	API3996	Panel U2 Row 7 Position 3
API2339	Panel X2 Row 1 Position 4	API4010	Panel U2 Row 1 Position 3
		API4011	Panel U2 Row 1 Position 2

Part No.	Location	Part No.	Location
API4019	Panel V1 Row 2 Position 3	API6322	Panel Z1 Row 4 Position 2
API4020	Panel V1 Row 2 Position 4	API6421	Panel X2 Row 1 Position 2
API4021	Panel T1 Row 2 Position 4	API6622	Panel U2 Row 7 Position 2
API4023	Panel V2 Row 1 Position 3	API6695	Panel T2 Row 5 Position 2
API4032	Panel T1 Row 5 Position 2	API6818	Panel T1 Row 4 Position 3
API4036	Panel T1 Row 5 Position 3	API6826	Panel Y1 Row 5 Position 3
API4127	Panel V2 Row 6 Position 3	API6834	Panel V2 Row 4 Position 1
API4163	Panel U1 Row 4 Position 4	API6835	Panel V1 Row 7 Position 4
API4260	Panel V1 Row 3 Position 4	API6842	Panel Z1 Row 4 Position 1
API4267	Panel W2 Row 3 Position 1	API6846	Panel Z1 Row 3 Position 3
API4274	Panel W1 Row 8 Position 2	API6858	Panel V1 Row 5 Position 2
API4291	Panel U1 Row 2 Position 2	API6864	Panel V2 Row 5 Position 3
API4298	Panel Z2 Row 4 Position 3	API6960	Panel Y1 Row 4 Position 3
API4313	Panel W1 Row 8 Position 3	API7004	Panel U1 Row 4 Position 3
API4328	Panel U1 Row 6 Position 1	API7006	Panel V2 Row 4 Position 3
API4355	Panel U1 Row 2 Position 1	API7034	Panel Y1 Row 6 Position 1
API4473	Panel Y1 Row 4 Position 4	API7057	Panel V1 Row 6 Position 4
API4546	Panel Z2 Row 5 Position 1	API7075	Panel T2 Row 4 Position 4
API4547	Panel Z2 Row 5 Position 2	API7098	Panel Y1 Row 3 Position 2
API4642	Panel Y2 Row 4 Position 1	API7103	Panel U2 Row 7 Position 1
API4695	Panel W Row 1 Position 3	API7121	Panel V2 Row 5 Position 4
API4696	Panel V1 Row 3 Position 2	API7143	Panel V1 Row 7 Position 3
API4697	Panel V1 Row 3 Position 3	API7144	Panel V1 Row 8 Position 3
API4737	Panel U1 Row 3 Position 1	API7216	Panel V1 Row 1 Position 4
API4753	Panel V1 Row 6 Position 2	API7222	Panel U2 Row 6 Position 3
API4921	Panel T1 Row 2 Position 3	API7267	Panel V1 Row 4 Position 4
API4992	Panel V1 Row 6 Position 1	API7315	Panel Y1 Row 5 Position 1
API4994	Panel V1 Row 8 Position 2	API7316	Panel Y1 Row 5 Position 2
API4997	Panel V1 Row 5 Position 1	API7339	Panel U1 Row 5 Position 1
API5042	Panel V1 Row 3 Position 1	API7379	Panel V1 Row 4 Position 1
API5044	Panel V1 Row 2 Position 2	API7459	Panel X1 Row 5 Position 4
API5170	Panel Y1 Row 5 Position 4	API7472	Panel V1 Row 6 Position 3
API5172	Panel X2 Row 7 Position 2	API7612	Panel T1 Row 3 Position 4
API5326	Panel W, Row 5 Position 1	API7615	Panel V2 Row 4 Position 2
API5335	Panel W1 Row 5 Position 3	API7632	Panel V1 Row 4 Position 3
API5367	Panel T1 Row 3 Position 3	API7639	Panel V2 Row 7 Position 1
API5373	Panel X1 Row 8 Position 4	API7649	Panel T2 Row 2 Position 1
API5456	Panel T2 Row 1 Position 3	API7650	Panel X1 Row 4 Position 4
API5457	Panel T2 Row 1 Position 1	API7664	Panel T1 Row 1 Position 4
API5461	Panel T2 Row 5 Position 3	API7975	Panel U1 Row 3 Position 4
API5479	Panel T1 Row 8 Position 3	API7980	Panel Y1 Row 3 Position 3
API5480	Panel T1 Row 7 Position 4	API8033	Panel U1 Row 5 Position 4
API5481	Panel T1 Row 7 Position 3	API8108	Panel V2 Row 1 Position 4
API5543	Panel T1 Row 6 Position 1	API8114	Panel T2 Row 8 Position 4
API5677	Panel Z1 Row 1 Position 2	API8119	Panel V1 Row 8 Position 1
API5695	Panel Y2 Row 2 Position 4	API8153	Panel W1 Row 5 Position 4
API5711	Panel W2 Row 3 Position 4	API8167	Panel W1 Row 2 Position 1
API5752	Panel Z1 Row 8 Position 3	API8297	Panel U1 Row 2 Position 3
API5774	Panel X1 Row 4 Position 2	API8301	Panel T1 Row 5 Position 1
API5775	Panel X1 Row 8 Position 3	API8340	Panel X1 Row 5 Position 3
API5970	Panel T2 Row 3 Position 2	API8353	Panel U1 Row 8 Position 4
API6000	Panel V1 Row 4 Position 2	API8354	Panel X2 Row 1 Position 1
API6251	Panel W1 Row 3 Position 4	API8461	Panel V2 Row 4 Position 4
API6253	Panel W1 Row 3 Position 3		

Part No.	Location	Part No.	Location
API8848	Panel T2 Row 2 Position 4	AP20360	Panel T2 Row 7 Position 2
API8873	Panel V1 Row 1 Position 1	AP20366	Panel T1 Row 6 Position 2
API8877	Panel U1 Row 5 Position 3	AP20377	Panel Y2 Row 5 Position 4
API8888	Panel U2 Row 3 Position 4	AP20380	Panel Z2 Row 4 Position 4
API8915	Panel T2 Row 4 Position 1	AP20390	Panel Y2 Row 3 Position 2
API8930	Panel T2 Row 4 Position 3	AP20391	Panel Y2 Row 3 Position 3
API9114	Panel U1 Row 1 Position 1	AP20440	Panel W2 Row 2 Position 3
API9118	Panel U2 Row 3 Position 2	AP20446	Panel X2 Row 7 Position 4
API9140	Panel V1 Row 7 Position 1	AP20455	Panel X1 Row 6 Position 2
API9171	Panel U1 Row 5 Position 2	AP20458	Panel U2 Row 8 Position 2
API9194	Panel W2 Row 2 Position 1	AP22439	Panel U1 Row 1 Position 4
API9233	Panel U2 Row 5 Position 1	AP20530	Panel T1 Row 7 Position 1
API9239	Panel U2 Row 3 Position 1	AP20564	Panel U2 Row 5 Position 4
API9246	Panel U2 Row 5 Position 2	AP20607	Panel Y2 Row 5 Position 1
API9270	Panel T2 Row 5 Position 1	AP20616	Panel T2 Row 6 Position 1
API9274	Panel U2 Row 4 Position 1	AP20627	Panel V2 Row 3 Position 3
API9278	Panel X1 Row 7 Position 4	AP20629	Panel V2 Row 5 Position 1
API9378	Panel Y2 Row 2 Position 2	AP20632	Panel V1 Row 1 Position 2
API9386	Panel T2 Row 3 Position 4	AP20680	Panel X2 Row 8 Position 4
API9422	Panel V1 Row 1 Position 3	AP20687	Panel Y2 Row 3 Position 1
API9453	Panel U2 Row 4 Position 4	AP20688	Panel Y2 Row 3 Position 4
API9613	Panel V1 Row 8 Position 4	AP20741	Panel V2 Row 6 Position 2
API9614	Panel W2 Row 3 Position 2	AP20754	Panel V2 Row 2 Position 3
API9615	Panel U2 Row 8 Position 3	AP20757	Panel Z1 Row 7 Position 4
API9626	Panel Y2 Row 1 Position 2	AP20758	Panel Z1 Row 6 Position 4
API9639	Panel U2 Row 6 Position 2	AP20774	Panel Y2 Row 5 Position 2
API9655	Panel U1 Row 4 Position 1	AP20788	Panel V2 Row 3 Position 2
API9756	Panel W2 Row 2 Position 2	API2658	Panel V2 Row 3 Position 4
API9777	Panel Y1 Row 3 Position 4	AP20869	Panel U2 Row 2 Position 2
API9801	Panel U2 Row 6 Position 1	AP20880	Panel U1 Row 8 Position 1
API9807	Panel Y2 Row 2 Position 1	AP20888	Panel U2 Row 6 Position 4
API9822	Panel Y2 Row 6 Position 1	AP20889	Panel U2 Row 8 Position 4
API9837	Panel T1 Row 4 Position 2	AP20895	Panel W1 Row 6 Position 1
AP20164	Panel U1 Row 1 Position 3	AP20908	Panel U2 Row 2 Position 3
AP20192	Panel T1 Row 2 Position 1	AP20931	Panel U2 Row 8 Position 1
AP20247	Panel U2 Row 4 Position 2	AP20953	Panel U1 Row 1 Position 2
AP20259	Panel X1 Row 6 Position 1	AP20954	Panel W2 Row 1 Position 4
AP20268	Panel Y2 Row 8 Position 1	AP20955	Panel U2 Row 3 Position 3
AP20316	Panel T1 Row 6 Position 3	AP20971	Panel V2 Row 8 Position 1
AP20327	Panel U2 Row 5 Position 3		
AP20328	Panel Y2 Row 5 Position 3		
AP20335	Panel U2 Row 2 Position 1		
AP20348	Panel V1 Row 5 Position 3		
AP20349	Panel U2 Row 2 Position 4		

AP448-CK

Conversion Kit to Upgrade AP448 Display



2 Bags Of Each The 60 New Auvecopak Items
New Backboard Labels
1 AIG-3 (Auvecopak I.D. Guide)



AP448-GP

New Graphics for AP448 Display

7 New End Strips
Two New Top Cards

BODY HARDWARE MASTER ASSORTMENTS

6000 & 6500 series Fix-Kits are listed on pages 343-363

Sec. 15

A great introduction to prospective accounts or
an exciting new program to increase sales with existing customers



6650BHM

Includes any combination of four drawers
from our entire 6600BHM series and one

MUST select four assortments to
qualify for the free cabinet

FREE
2-96 cabinet

A complete program that provides body shops with 21,000 pieces of the most
popular body hardware and specialty fastener items

6600BHM is based on our popular **BHDB-1**,
Body Hardware Display Book (not included)
20 metal drawers, pre-labeled and pre-loaded with
Auveco unit package quantities for easy refill

WARNING: Reproductive Harm & Cancer
www.P65Warnings.ca.gov

Photos not actual size

6601BHM

Small Retainers &
Retaining Clips
24 Varieties, 840 Pieces

Contains Following Part No.

10621	11612	11796	12565
12737	12992	13470	14021
14291	14328	14736	14737
15367	15970	17339	18033
18114	18297	18848	18877
19114	19682	19729	20543



6603BHM

Hood Insulation Retainers,
Trim Panel Fasteners
& Rubber Vacuum Caps
16 Varieties, 440 Pieces

Contains Following Part No.

4439	4440	11863	11130
12134	12209	12210	12907
12908	14163	15456	19613
19614	19655	20757	20758



6602BHM

Large Retainers
22 Varieties, 965 Pieces

Contains Following Part No.

10831	12137	12571	12731
12759	12766	12909	14036
14738	15414	15479	15543
15998	16818	17004	17612
17664	17975	19837	20192
	20362	20366	



6604BHM

Push-Type Retainers
24 Varieties, 445 Pieces

Contains Following Part No.

14260	14753	14992	14997
16000	16858	17057	17143
17144	17267	17379	17472
17632	8119	18888	19118
19239	19739	20335	20348
20349	20869	20908	20955



Photos not actual size

6605BHM

Push-Type Retainers
24 Varieties, 492 Pieces



Contains Following Part No.

12757	13993	13996	14010
14019	14020	17216	17222
18873	19233	19246	19274
19422	19453	19615	19639
19801	20247	20327	20564
20632	20889	20931	20986

6606BHM

Push-Type Retainers,
Nylon Rivets
& Specialty Rivets
24 Varieties, 680 Pieces



Contains Following Part No.

12567	12652	13748	13750
13751	13753	13755	14011
14023	14127	16834	16864
17006	17121	17410	17615
17639	18108	18167	18353
18461	19376	20629	20741

6607BHM

Specialty Rivets, Double End
Drill & Moulding Clips
24 Varieties, 925 Pieces



Contains Following Part No.

8301	8311	8313	8925
8931	12653	12655	12658
12676	14642	16837	16838
19757	19821	19822	20328
20377	20523	20607	20626
20627	20774	20788	20834

WARNING: Reproductive Harm & Cancer www.P65Warnings.ca.gov

6608BHM

Moulding Clips & Fasteners,
Plug Buttons &
Wire Loom Clips
22 Varieties, 840 Pieces



Contains Following Part No.

2619	2744	2752	8941
9288	9633	9749	9965
11746	14545	14546	14547
19378	19626	19807	20390
20391	20392	20397	20429
	20687	20688	

WARNING: Reproductive Harm & Cancer www.P65Warnings.ca.gov

6609BHM

Phillips Oval Head, Phillips Pan
Head & Specialty
Tapping Screws (Chrome & Zinc)
24 Varieties, 2400 Pieces

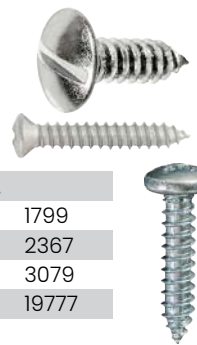

Contains Following Part No.

1423	1483	1717	1794	1796	1799
1940	1943	2027	2365	2366	2367
2710	2713	2728	2730	2731	3079
3090	9603	9605	12095	15172	19777

WARNING: Reproductive Harm & Cancer www.P65Warnings.ca.gov

6610BHM

Phillips Oval Head Sems® (Chrome & Black
Phosphate) & Hex Washer
Head (Zinc and Yellow Zinc)
Tapping Screws



Contains Following Part No.

2751	2772	2773	2775	3466	3467
9611	9615	11369	11450	11451	11455
11456	11788	11789	11790	11791	11792
11914	15170	16828	16960	17098	17980

WARNING: Reproductive Harm & Cancer www.P65Warnings.ca.gov

6611BHM

Phillips Oval Head (Black Oxide),
Phillips Pan Head (Black Oxide) &
Specialty Tapping Screws
(Black E-Coat)
24 Varieties, 2175 Pieces



Contains Following Part No.

10162	10164	10165	10166	10167	10168	10180	10181
10182	11086	11087	11088	11089	11917	11921	11922
11923	12796	12797	12799	12820	12957	16323	20259

6612BHM

Phillips Flat Top
Washer Head (Black),
Hex Head Sems® (Black)
& Hex Slotted Head (Black)
Tapping Screws
23 Varieties, 1750 Pieces



Contains Following Part No.

12060	12213	12214	12215	12216	12217
12218	12339	12351	12738	12742	12953
12954	13026	15373	15774	15775	16421
17459	17650	18340	18354	20455	

6613BHM

Hex Head Sems & Hex Washer
Head Body Bolts (Black)
21 Varieties, 810 Pieces



Contains Following Part No.

9480	10362	10823	11109
11110	11320	11641	12065
12066	12160	12232	12324
12336	12343	12693	13613
13614	13618	13619	18416
18769			

BODY HARDWARE MASTER ASSORTMENTS

Photos not actual size

Sec. 15

6614BHM

Hex Head Sems® & Hex Washer Head Body Bolts (Zinc), Bumper Bolts & Specialty Fasteners
12 Varieties, 445 Pieces

Contains Following Part No.

4474	5242	5246	8443
11295	12335	14473	14976
16826	17316	18262	19339



⚠️ WARNING: Reproductive Harm & Cancer www.P65Warnings.ca.gov

6615BHM

Spin Lock Nuts, Hex Flange Nuts, Free Spinning Washer Nuts, Expansion Nuts & Rubber Nuts
23 Varieties, 705 Pieces

Contains Following Part No.

11644	11645	12595	12596
12995	12999	13004	13007
13008	13009	13010	13014
13016	14855	15326	15329
15334	15335	16470	16769
16830	16883	20415	



6616BHM

J-Nuts, Spring Type U-Nuts & Extruded U-Nuts
23 Varieties, 965 Pieces

Contains Following Part No.

5586	5589	8359	8814
9879	9880	10051	10053
10054	10055	10064	10065
10066	10067	11628	11629
11630	11631	12575	12669
14750	15677	15752	



6617BHM

Flat Nuts, U-Nuts, Tubular Nuts & Shims
11 Varieties, 950 Pieces

Contains Following Part No.

1903	2089	2099	2293
2595	3155	3156	5076
5077	5196	11292	



6618BHM

Washer Lock Nuts, Thread Cutting Nuts, Push-On Retainers & Pushnut Bolt Retainers
23 Varieties, 2300 Pieces

Contains Following Part No.

2555	2557	2896	2897	3404	3405	8863	8864
8865	8868	8869	9297	9299	0086	10087	10374
10733	12123	12127	12253	12255	12259	14980	



6619BHM

Nylon Nuts & Screw Grommets
23 Varieties, 860 Pieces

Contains Following Part No.

3682	8435	9829	9862
11368	11691	11719	13450
13932	13933	13960	14031
14267	14268	14274	14275
14695	18153	19194	19721
19756	20440	20954	



6620BHM

Door Hinge Pins & Bushings, Headlight Hardware, Door Lock Rod Clips, Window Crank Handle Retainer Clips & Cable Straps
14 Varieties, 336 Pieces

Contains Following Part No.

2288	3178	11243	14298
14550	14553	14559	15518
15940	16936	16937	19424
19781	20380		



⚠️ WARNING: Reproductive Harm & Cancer www.P65Warnings.ca.gov

6649BHM

Small Size • Grade 5 USS • Cap Screws, Nuts & Washers
12 Varieties, 150 Pieces

Auveco Part No	Size
5434*	1/4"-20 x 1/2"
5436*	1/4"-20 x 3/4"
5438*	1/4"-20 x 1"
5449*	5/16"-18 x 3/4"
5451*	5/16"-18 x 1"
5452*	5/16"-18 x 1-1/4"
5453	5/16"-18 x 1-1/2"
5455	5/16"-18 x 2"
15586	1/4"-20 Hex Nut
15587	5/16"-18 Hex Nut
8606	1/4" USS Washer
8607	5/16" USS Washer



*Threaded to the head

6629BHM

J.I.S. Hex Flange Bolts & Spin Lock Nuts
21 Varieties, 550 Pieces

Auveco Part No.	Size
17315	M6-1.0 x 12mm
17316	M6-1.0 x 16mm
18807	M6-1.0 x 20mm
21048	M6-1.0 x 25mm
18808	M6-1.0 x 30mm
18809	M6-1.0 x 40mm
18980	M8-1.25 x 12mm
17387	M8-1.25 x 16mm
17388	M8-1.25 x 20mm
21051	M8-1.25 x 25mm
17389	M8-1.25 x 30mm
21052	M8-1.25 x 35mm
17390	M8-1.25 x 40mm
21053	M8-1.25 x 45mm
17188	M10-1.25 x 16mm
17189	M10-1.25 x 20mm
21054	M10-1.25 x 25mm
17190	M10-1.25 x 30mm
21055	M10-1.25 x 35mm
17191	M10-1.25 x 40mm
21056	M10-1.25 x 45mm
16769	M6-1.0 Nut
16830	M8-1.25 Nut
16470	M10-1.25 Nut



Photos not actual size

6630BHM

Nylon Connectors
& Rubber Vacuum Caps
24 Varieties,
310 Pieces



Auveco		
Part No.	Size	
Nylon Connectors		
12929	1/8" x 1/8"	Straight
12930	1/8" x 3/16"	Straight
12936	1/8" x 1/4"	Straight
12937	3/16" x 3/16"	Straight
12935	1/4" x 3/16"	Straight
12931	1/4" x 1/4"	Straight
12946	5/16" x 5/16"	Straight
12923	1/8" x 1/8" x 1/8"	Tee
12926	3/16" x 3/16" x 1/8"	Tee
12918	3/16" x 3/16" x 3/16"	Tee
12919	1/4" x 3/16" x 3/16"	Tee
11738	1/4" x 1/4" x 3/16"	Tee
17629	1/4" x 1/4" x 1/4"	Tee
12920	5/16" x 5/16" x 5/16"	Tee
12927	3/16" x 3/16" x 3/16"	Y
12943	1/4" x 1/4" x 1/4"	Y
12932	3/16" x 3/16"	Elbow
12939	3/16"	Cross
Rubber Caps		
12209	For 1/8" O. D. Tube	
4440	For 3/16" O. D. Tube	
4439	For 1/4" O. D. Tube	
12907	For 5/16" O. D. Tube	
12210	For 3/8" O. D. Tube	
12908	For 1/2" O. D. Tube	

6631BHM

Krimp and Seal
Terminals & Connectors
24 Varieties, 240 Pieces



Auveco		
Part No.	Description	
13656	Ring Type, 22-18 Ga.	
13657	Ring Type, 22-18 Ga.	
13658	Spade Type, 22-18 Ga.	
13659	Butt Conn., 22-18 Ga.	
13660	Female Q. C., 22-18 Ga.	
13661	Male Q. C., 22-18 Ga.	
13662	Ring Type, 16-14 Ga.	
13663	Ring Type, 16-14 Ga.	
13664	Ring Type, 16-14 Ga.	
13665	Ring Type, 16-14 Ga.	
13666	Ring Type, 16-14 Ga.	
13669	Butt Conn., 16-14 Ga.	
13670	Female Q. C., 16-14 Ga.	
13671	Male Q. C., 16-14 Ga.	
13672	Female Q. C., 16-14 Ga.	
13673	Male Q. C., 16-14 Ga.	
13681	Female Plug, 16-14 Ga.	
13682	Male Plug, 16-14 Ga.	
13674	Ring Type, 12-10 Ga.	
13675	Ring Type, 12-10 Ga.	
13676	Ring Type, 12-10 Ga.	
13678	Butt Conn., 12-10 Ga.	
13679	Female Q. C., 12-10 Ga.	
13680	Male Q. C., 12-10 Ga.	

6632BHM

GM, Ford & Chrysler
Push-Type Retainers
12 Varieties - 400 Pieces

Contains Following Part No.

17216	2889	20888	20991
20826	20992	20880	20988
20989	20990	20993	20994



6628BHM

Oil Drain Plugs & Gaskets
24 Varieties, 105 Pieces



Auveco		
Part No.	Size	
14196	1/2"-20	
18373	1/2"-20	
19130	1/2"-20	
19365	1/2"-20,	Magnetic
15527	M12-1.25	
19588	M12-1.25	
14677	M12-1.75	
18023	M12-1.75	
18374	M12-1.75	
20347	M12-1.75	
21047	M12-1.75	
18024	M14-1.25	
14678	M14-1.5	
16308	M14-1.5	
18025	M14-1.5	
18375	M14-1.5	
19141	M14-1.5	
19279	M14-1.5	
19620	M14-1.5	Single Oversize
19773	M14-1.5	
20426	M14-1.5	
15528	M16.4-1.33	
15529	M18-1.5	
15530	M20-1.5	

WARNING: Reproductive Harm & Cancer
www.P65Warnings.ca.gov

6633BHM

Metal Specialty Rivets
24 Varieties -
850 Pieces



Auveco		
Part No.	Size	
1/8" (3.2mm) Diameter		
20788	Grip: 3/64" - 1/8"	
20627	Grip: 3/64" - 3/16"	
16834	Grip: 1/8" - 3/16"	
8931	Grip: 3/16" - 1/4"	
17615	Grip: 3/16" - 3/8"	
5/32" (4mm) Diameter		
18461	Grip: 3/64" - 1/4"	
20629	Grip: 3/64" - 1/4"	
20971	Grip: 3/64" - 9/32"	
19376	Grip: 1/8" - 11/32"	
17006	Grip: 1/4" - 3/8"	
3/16" (4.8mm) Diameter		
16864	Grip: 3/64" - 11/32"	
20741	Grip: 3/64" - 23/64"	
17121	Grip: 5/64" - 15/64"	
8311	Grip: 1/8" - 1/4"	
17410	Grip: 3/8" - 1/2"	
14127	Grip: 3/8" - 1/2"	
1/4" (6.4mm) Diameter		
16837	Grip: 1/32" - 9/64"	
12653	Grip: 3/32" - 1/8"	
18167	Grip: 3/32" - 9/64"	
12652	Grip: 1/8" - 1/4"	
12655	Grip: 9/64" - 3/16"	
17639	Grip: 3/16" - 3/8"	
8313	Grip: 1/4" - 3/8"	
16838	Grip: 33/64" - 19/32"	

WARNING: Reproductive Harm & Cancer
www.P65Warnings.ca.gov

Photos not actual size

The economical choice – a complete universal assortment program providing shops the most popular body hardware & specialty fasteners

EPA PROGRAM 6700EPA

12 metal drawers, pre-labeled and pre-loaded for easy refill

Three **FREE** 2-96 cabinets

- 6701EPA: Body Bolts
- 6702EPA: Moulding Clips
- 6703EPA: Nylon Rivets
- 6704EPA: Specialty Rivets
- 6705EPA: Push-Type Retainers #1
- 6706EPA: Specialty Nuts
- 6707EPA: Screw Grommets & Nylon Nuts
- 6708EPA: Extruded U-Nuts
- 6709EPA: Push-Type/Screw-Type Retainers
- 6710EPA: Specialty & Tapping Screws
- 6711EPA: Hood & Single Head Retainers
- 6712EPA: J & U Nuts

Assortments included with the 6700EPA

⚠ WARNING: Reproductive Harm & Cancer
www.P65Warnings.ca.gov



CUSTOM EPA PROGRAM 6750EPA

Choose any combination of four drawers within our EPA series and receive one **FREE** 2-96 cabinet

MUST select four assortments to qualify for the free cabinet



2-96 cabinet

ADDITIONAL ASSORTMENTS

9 additional metal drawer assortments are available in addition to our EPA Program
Mix and match to best suit your body shops' individual needs

6701EPA

Body Bolts
21 Varieties, 395 Pieces

Contains Following Part No.

9480	10823	11109	11110
11320	11641	12065	12066
12160	12232	12323	12335
12336	12963	13613	13614
15783	15791	16826	17034
17035			



⚠ WARNING: Reproductive Harm & Cancer
www.P65Warnings.ca.gov

6702EPA

Moulding Clips
20 Varieties, 180 Pieces

Contains Following Part No.

20377	20390	20391	20607
20687	20688	20774	21136
21158	21242	21244	21285
21316	21374	21484	21668
21683	22015	22099	22124



6703EPA

Nylon Rivets
12 Varieties, 240 Pieces

Contains Following Part No.

13747	13748	13750	13751
13752	13753	13755	14004
14023	17101	18108	20754



6708EPA

Extruded U-Nuts
21 Varieties, 360 Pieces

Contains Following Part No.

8359	8814	10048	10051
10053	10054	10055	11628
11629	11630	11631	12666
12669	15677	16322	16842
16846	18338	21040	22074
22700			



6704EPA

Specialty Rivets
21 Varieties, 360 Pieces

Contains Following Part No.

11620	11621	12653	12658
14127	16834	16837	16838
16864	17006	17121	17615
17639	18167	18461	20626
20627	20629	20741	20788
20971			



WARNING: Reproductive Harm & Cancer
www.P65Warnings.ca.gov

6709EPA

Push-Type/Screw-Type Retainers
18 Varieties, 285 Pieces

Contains Following Part No.

14260	14696	14753	14992
14997	16000	16858	16859
17057	17143	17379	17472
17632	20348	21103	21146
21500	21530		



6705EPA

Push-Type Retainers
22 Varieties, 360 Pieces

Contains Following Part No.

12567	12757	14010	14011
14020	17222	19274	19453
19615	19639	20458	20757
20880	20888	20909	20931
20966	20989	20990	20992
21011	22710		



6710EPA

Specialty and Tapping Screws
22 Varieties, 700 Pieces

Contains Following Part No.

9611	9615	11369	12095
12213	12214	12215	12216
12351	12953	12954	13709
15774	16421	16828	17650
18340	18354	19170	19278
20259	20455		



WARNING: Reproductive Harm & Car
www.P65Warnings.ca.gov

6706EPA

Specialty Nuts
17 Varieties, 335 Pieces

Contains Following Part No.

11644	11645	12595	12596
14855	15326	15328	15329
15331	15332	15335	15337
15347	15351	16470	16769
16830			



WARNING: Reproductive Harm & Cancer
www.P65Warnings.ca.gov

6707EPA

Screw Grommets and Nylon Nuts
18 Varieties, 335 Pieces

Contains Following Part No.

8435	11719	14267	14274
14695	19194	19721	19756
20440	20764	20895	20954
22701	22719	22720	22721
22723	22766		



6711EPA

Hood and Single Head Retainers
22 Varieties, 415 Pieces

Contains Following Part No.

11146	11612	12571	12766
14021	14036	15367	15543
17004	17339	18033	18114
18297	18877	19114	19171
19682	19729	20164	20192
20543	21307		



6712EPA

J and U Nuts
14 Varieties, 440 Pieces

Contains Following Part No.

2293 5589 9879 9880
10064 10065 10066 10067
11292 13216 14750 15752
20956 21017

 **WARNING:** Reproductive Harm & Cancer
www.P65Warnings.ca.gov



6713EPA

Push-Type Retainers
22 Varieties, 230 Pieces

Contains Following Part No.

17162 17216 18873 19239
20327 20349 20564 20632
20889 20908 20988 20991
21173 21192 21201 21328
21420 21422 21658 22039
22253 22703



6714EPA

Pushnut Retainers
21 Varieties, 1,000 Pieces

Contains Following Part No.

8863 8864 8865 8868
8869 9299 10085 10086
10087 10374 12123 12126
12127 14980 16851 16852
22797 22798 22799 22800
22802



6715EPA

Door,
Rocker Panel,
and Weatherstrip Retainers
18 Varieties, 370 Pieces

Contains Following Part No.

12565 12737 12992 13470
14328 14921 18692 18848
19821 19822 19850 20316
20607 20774 21334 21374
21705 22767



6716EPA

Universal Retainers
22 Varieties, 405 Pieces

Contains Following Part No.

10831 11146 12137 12731
12759 12909 14032 15478
15479 15480 16818 17612
17664 18301 19250 19837
19893 20360 20366 20926
22473 22555



6717EPA

Foreign Splash Shield
18 Varieties, 205 Pieces

Contains Following Part No.

14260 16858 17379 19233
19239 19246 19274 20564
20869 20908 20953 20955
20959 20986 21173 21192
21294 21706



6718EPA

Domestic Splash Shield
18 Varieties, 310 Pieces

Contains Following Part No.

11146 12065 12323 12336
12567 12693 12757 13614
13705 13993 13994 14011
14036 18301 18416 19278
19801 20880



6719EPA

Domestic Splash Shield
18 Varieties, 310 Pieces

Contains Following Part No.

10831 12137 12160 12324
12335 12766 14019 14020
15543 16859 17216 17664
19418 20458 20991 21098
22348 22352



6720EPA

Specialty Screws
17 Varieties, 650 Pieces

Contains Following Part No.

2751 2771 2772 2775
11451 11455 11457 11787
11788 11789 11790 11791
11792 12217 12218 12820
12955



6721EPA

Tesla Clips and Fasteners
16 Varieties, 320 Pieces

Contains Following Part No.

12119 17421 19453 20349
20633 20765 21169 25112
25151 25152 25153 25179
25284 25285 25286 25287



MA100

OEM Specific Oil Drain Plugs & Gaskets
23 Varieties, 108 Pieces

Contains Following Part No.

15529	15530	18024	18026
18373	18374	18375	19130
19141	19279	19589	19773
20347	20426	20746	21047
21293	21326	21353	21354
24265	24268	24271	



WARNING: Reproductive Harm & Cancer www.P65Warnings.ca.gov

MA101

Oil Drain Plugs & Gaskets
23 Varieties, 400 Pieces

Contains Following Part No.

14677	14678	15527	15528
15529	15530	16682	16956
18019	18024	18025	18026
18726	18829	19130	19589
20426	20454	21353	21647
21677	24268	24330	



WARNING: Reproductive Harm & Cancer www.P65Warnings.ca.gov

MA102

Oil Drain Gaskets
23 Varieties, 490 Pieces

Contains Following Part No.

16026	16682	16956	17261
17262	18019	18299	18665
18726	18849	19007	19139
19591	19592	19601	19621
20453	20454	20462	20896
21179	21258	21677	



Photos not actual size

Small cabinet and drawers with plastic inserts are made of study heavy gauge steel. The kits are designed with scoop compartments and slide easily onto the cabinet slide. All items are available in unit packages. For refills, order by Auveco number on lid label.

Empty Drawers

(13-5/16" Wide x 9-1/4" Deep x 2" High)
With Locking Latch:

- 2-608: 8 Compartment
- 2-612: 12 Compartment
- 2-616: 16 Compartment
- 2-624: 24 Compartment



4-60

Empty Cabinet. Holds 4 Small Drawers.
15-1/4" Wide x 11-3/4" Deep x 11-1/4" High
Finish: Light Green Enamel
Drawer Size: 13-5/16" Wide x 9-1/4" Deep x 2" High



6-60

Cabinet & 6 Empty Small Drawers
24 Compartment Drawers with Locking Latches
15-1/4" W x 11-3/4" D x 16-3/8" H
Finish: Light Green Enamel
Drawer Size: 13-5/16" Wide x 9-1/4" Deep x 2" High

3-60

Empty Cabinet. Holds 6 Small Drawers



1-900S

Large Clear Vinyl Adhesive Back Sleeve

Size: 17-5/8 x 11-9/16"

Use with Large Metal Drawer (18" x 12" x 3")

Fits Auveco's Large Metal Drawer Assortments: 6500 Fix-Kits and 6600BHM Body Hardware Master



2-600S

Small Clear Vinyl Adhesive Back Sleeve

Size: 13" x 8-3/4"

Use with Small Metal Drawer (13-5/16" x 9-1/4" x 2")

Fits Auveco's Small Metal Drawer Assortments: 6000 Fix-Kits

LARGE EMPTY DRAWERS AND CABINETS

Photos not actual size

3-96R

*Photo not actual size



Empty 2-Drawer Cabinet with Roller Bearings
Holds 2 Large Drawers
20" Wide x 15-3/4" Deep x 8" High
Finish: Light Green Enamel
Drawer Size: 18" Wide x 12" Deep x 3" High
Replaces Auveco No. 3-96

UNIT PACKAGE: 1



4-96

Cabinet & 4 Empty Large Drawers

24 Compartment Drawers with Locking Latches
20" Wide x 15-3/4" Deep x 14-1/2" High
Finish: Light Green Enamel
Drawer Size: 18" Wide x 12" Deep x 3" High

2-96

Empty Cabinet. Holds 4 Large Drawers

Base B-3 for cabinets 3-96R, 4-96 and 2-96 is pictured on page 352



1-900

Steel with Locking Latch

18 x 12 x 3
Adjustable
Compartment
Empty Drawer with
3 Vertical &
3 Horizontal
Dividers

UNIT PACKAGE: 1

Empty Drawers

(18" Wide x 12" Deep x 3" High)
With Locking Latches:

- 1-912: 12 Compartment
- 1-916: 16 Compartment
- 1-920: 20 Compartment
- 1-924: 24 Compartment
- 1-932: 32 Compartment



1-901

Steel with Locking Latch

18 x 12 x 3
Adjustable
Compartment
Empty Drawer
with 9 dividers

UNIT PACKAGE: 1



1-901 DIVIDERS

2-15/16" x 4-5/16"
Divider
for 1-901 Drawer

Photos not actual size

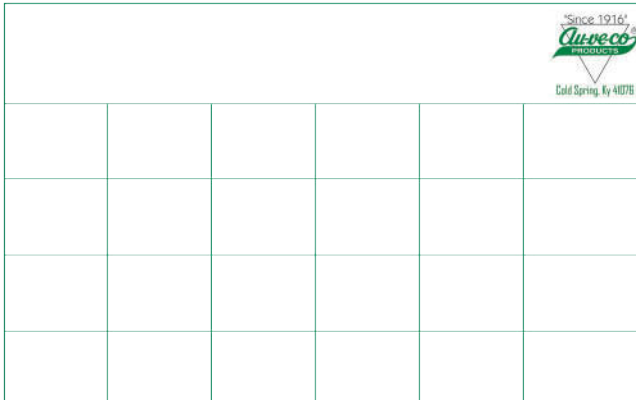

Printed lid labels in 12, 16, 20 and 24 compartment layouts (small and large drawer sizes). Same size and layout as Fix-Kit lid labels. Labels have a peel-away liner and self-adhesive backing for permanent adhesion.

Large Drawer Lid Labels

1-900L

Assortment of 1 each of 1-912L, 1-916L, 1-920L & 1-924L.

UNIT PACKAGE: 1 Set

1-912L

Large Drawer 12
Compartment Lid Label

UNIT PACKAGE: 5

1-916L

Large Drawer 16
Compartment Lid Label

UNIT PACKAGE: 5

1-920L

Large Drawer 20
Compartment Lid Label

UNIT PACKAGE: 5

1-924L

Large Drawer 24
Compartment Lid Label

UNIT PACKAGE: 5



1-MBC

Miniature Bulb Cabinet

19" Wide x 4" Deep x 26-3/4" High

Ideal for the storage and organization of automotive miniature bulbs, fuses, etc. Features 4 durable plastic tilt-out trays with 28 adjustable dividers allowing for the creation of 4 to 32 compartments.

Back-up storage shelves are located behind the hinged cover. Can be hung on wall using keyholes punched in the back. Constructed of prime cold rolled steel with grey powder coat finish.

Can be shipped via UPS



1-WSR

Wire Spool Rack

26-1/8" Wide x 6" Deep x 37-1/8" High

Four sturdy steel rods provide secure and convenient storage for reels as large as 11" in diameter.

Heavy duty steel with enamel finish.

Does not include wire.

Weight: 20 lbs.

Can be shipped via UPS



Photos not actual size



P277

40 Compartment Bin

33-3/4" Wide x 12" Deep x 24" High
Color: green or gray enamel finish
Packing: 1 set up unit per carton
Shipping Weight: 47 lbs.

Can be shipped via UPS

P40-S

40 Compartment Bin

33-3/4" Wide x 9" Deep x 24" High
Color: green enamel finish
Packing: 1 set up unit per carton
Shipping Weight: 38 lbs.

Can be shipped via UPS

MB-36

Multi-Purpose Bin



23-5/8" Wide x 4-3/4" Deep x 23-5/8" High.
Removable vertical dividers allow the creation of double-width openings, each with scoops. Keyhole slots are provided for wall mounting.
Shipping Weight: 25 lbs.

Can be shipped via UPS

Bin Bases



B-1

Base for Bins P277 & 18-D

Raises units 4 or 8 inches off the floor
Color: green enamel finish

UNIT PACKAGE: 1

B-2

Base for Bin P40-S

Raises unit 4 or 8 inches off the floor
Color: green enamel finish

UNIT PACKAGE: 1

Can be shipped via UPS



18-D

18 Drawer Cabinet (with 36 Dividers)

34" Wide x 11-1/4" Deep x 11" High
Color: Green enamel finish
Shipping Weight: 47 lbs.

Can be shipped via UPS



9-D

9 Drawer Cabinet (with 18 Dividers)

17-1/4" Wide x 11-5/8" Deep x 10-7/8" High
Shipping Weight 28 lbs.

Can be shipped via UPS

Dividers

For 18-D and 9-D

Plastic
2-1/2" x 5-3/16"

UNIT PACKAGE: 1



1-ACC

Aerosol Can Caddy

21-1/2" Wide x 3-1/8" Deep x 5-1/4" High
Holds 6 cans with a maximum can diameter of 3"
Holes are provided for wall mounting.

Does not include cans.
Shipping Weight: 2 lbs.

Can be shipped via UPS



BIN LABELS

Photos not actual size

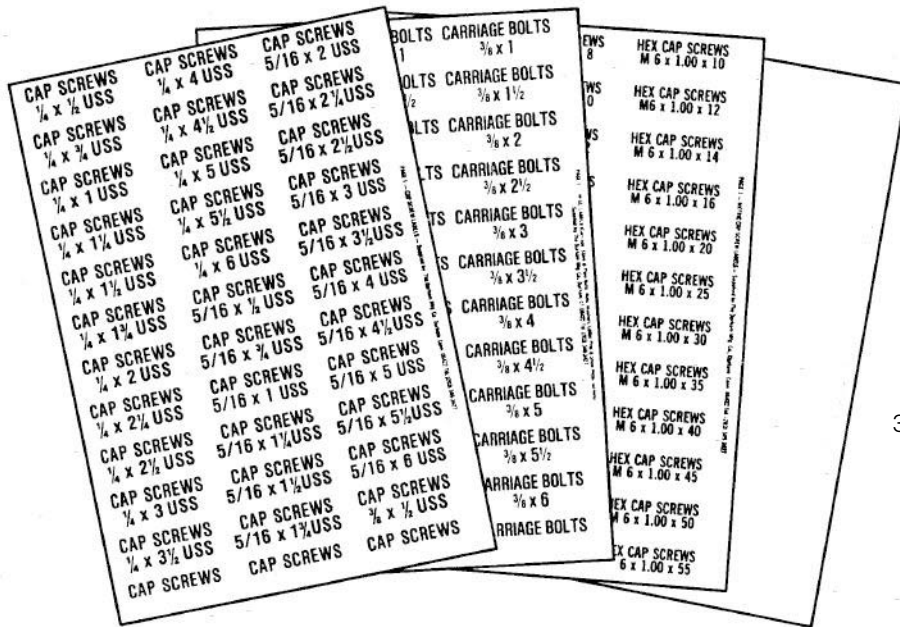

2" x 3/4" Pressure Sensitive Bin Labels Covering Popular Size U.S.S., S.A.E. and Metric Fasteners. 36 Labels per each 6-1/4" x 9" page.

15531

U.S.S. Fastener Labels for Cap Screws, Nuts, Lock Washers, Flat Washers and Blanks

Diameters: 1/4", 5/16", 3/8", 7/16", 1/2", 9/16", 5/8", 3/4", 7/8", & 1"
Lengths: 1/2" thru 6"
Total of 6 pages

UNIT PACKAGE: 1 Set

15532

S.A.E. Fastener Labels for Cap Screws, Nuts, Lock Washers, Flat Washers and Blanks

Diameters: 1/4", 5/16", 3/8", 7/16", 1/2", 9/16", 5/8", 3/4", 7/8", & 1"
Lengths: 1/2" thru 6"
Total of 6 pages

UNIT PACKAGE: 1 Set

15533

Bin Labels Assortment
Consists of 1 set each of 15531, 15532, 14774 & 14775

UNIT PACKAGE: 1 Set

14774

Metric Fastener Labels for Hex Cap Screws (Regular & Fine Thread), Hex Nuts, Nylon Insert Lock Nuts, Split Lock Washers, Flat Washers, Wave Washers, Socket Cap Screws and Socket Set Screws

Diameters: 4mm, 5mm, 6mm, 7mm, 8mm, 10mm, 12mm, 14mm, 16mm, 20mm & 24mm.
Total of 9 pages

UNIT PACKAGE: 1 Set

14775

Blank Labels
5 pages of labels to be written on with a ball point pen.

UNIT PACKAGE: 1 Set

DB-428L

Body Shop Bin Labels



Self-adhesive, pre-printed labels for 428 very popular Auveco body shop items. These labels are based on the contents of our DB-428 Display Boards, which are the items that we recommend everyone stock.

Each label measures 2-13/16" x 1" and contains an Auveco part number, description, OEM number, photograph and unit package quantity. Included are 22 blank labels for future new items. There are 15 pages in one set.

UNIT PACKAGE: 1 Set

BODY SHOP BIN ASSORTMENTS

Photos not actual size



Having the right part for the job is easy with our assortments for domestic and import vehicle applications. Each assortment contains 36 of the top selling retainers and clips along with a pre-labeled Auveco MB-36 bin.

This 36 compartment bin measures 23-5/8" wide x 4-3/4" deep x 23-5/8" high. In addition to showing the Auveco part number and bar code, the labels include O.E.M. numbers as well.

Can be shipped via UPS

Domestic Vehicle "Xmas Tree" & Push-Type Retainers

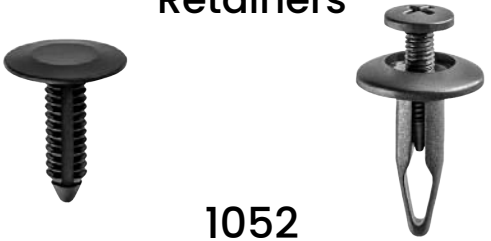

1052

1 box each (1,130 pieces) of the following parts and a MB-36 bin:

10831	12909	16818
11130	13993	17216
11146	13996	17222
11612	14010	17339
12137	14020	17612
12565	14021	17664
12567	14036	18033
12571	14753	18353
12731	14992	19422
12757	15456	19639
12759	15479	20192
12766	15543	20632

1053

Same as 1052 except without MB-36 bin.

Import Vehicle Retaining Clips, Push-Type Retainers & Screw Grommets



1054

1 box each (601 pieces) of the following parts and a MB-36 bin:

14260	18877	19729
14267	18888	20247
14737	19114	20327
16000	19118	20349
16858	19194	20380
17143	19233	20440
17379	19239	20564
17472	19246	20869
17632	19274	20908
18114	19453	20931
18297	19552	20955
18873	19721	20986

1055

Same as 1054 except without MB-36 bin.

FASTENER ASSORTMENTS

Photos not actual size

Sec. 15



Bin P40-S

Each assortment includes an Auveco 40 compartment bin P40-S (33-3/4" Wide x 9" Deep x 24" High). The reorder labels contain the fastener part number, size, description and bar code. All parts are certified to meet or exceed the proper S.A.E. specifications both physically and chemically.

Can be shipped via UPS

1020

Grade 5 U.S.S. (Coarse Thread) Fastener Assortment.

Over 2,800 pieces of Grade 5 U.S.S. cap screws, hex nuts, high alloy lock washers and high alloy S.A.E. flat washers.

Diameters: 1/4"-20, 5/16"-18, 3/8"-16, 7/16"-14 and 1/2"-13.

Lengths: 1/2" through 3".

All fasteners are zinc plated.

Refer to contents listing on next page.

⚠ WARNING: Reproductive Harm & Cancer
www.P65Warnings.ca.gov

1021

Same as 1020 except without P40-S bin. Includes planogram and reorder labels.

⚠ WARNING: Reproductive Harm & Cancer
www.P65Warnings.ca.gov

1030

Grade 8 U.S.S. (Coarse Thread) Fastener Assortment.

Over 2,000 pieces of Grade 8 U.S.S. cap screws, hex nuts, high alloy lock washers and high alloy S.A.E. flat washers.

Diameters: 1/4"-20, 5/16"-18, 3/8"-16, 7/16"-14, 1/2"-13 and 5/8"-11.

Lengths: 1/2" through 4".

All fasteners are yellow zinc dichromate plated.

Refer to contents listing on next page.

⚠ WARNING: Reproductive Harm & Cancer
www.P65Warnings.ca.gov

1031

Same as 1030 except without P40-S bin. Includes planogram and reorder labels.

⚠ WARNING: Reproductive Harm & Cancer
www.P65Warnings.ca.gov

METRIC FASTENER ASSORTMENTS

1040

Metric Fastener (Regular Pitch) Assortment.

Over 1,200 metric cap screws, hex nuts, lock washers and flat washers.

Assortment comes with a pre-labeled Auveco 40 compartment bin, P40-S (33-3/4" Wide x 9" Deep x 24" High). The reorder labels contain the fastener part number, size, description and bar code.

Diameters: 6mm-1.00, 8mm-1.25, 10mm-1.50 and 12mm-1.75.

Lengths: 10mm through 50mm.

All fasteners are zinc plated.

Refer to contents listing on next page.

Can be shipped via UPS

1041

Same as 1040 except without P40-S Bin. Includes planogram and reorder labels.

1042

Metric Fastener (Regular & Fine Pitch) Assortment.

Over 1,995 metric cap screws, hex nuts, lock washers and flat washers.

Assortment comes with a pre-labeled Auveco 40 compartment bin, P40-S (33-3/4" Wide x 9" Deep x 24" High). The reorder labels contain the fastener part number, size, description and bar code.

Diameters: M5-.8, M6-1.0, M8-1.25, M8-1.0, M10-1.5, M10-1.25, M10-1.0 & M12-1.75.

Lengths: 10mm through 75mm.

All fasteners are zinc plated except fine pitch cap screws which have a black finish.

Refer to contents listing on following pages.

Can be shipped via UPS

1043

Same as 1042 except without P40-S Bin. Includes planogram and reorder labels.

FASTENER ASSORTMENTS CONTENTS

1020 & 1021

Grade 5 U.S. (Coarse Thread) Fastener Assortments. Contains 1 box each of:

5434	1/4"-20 x 1/2" Cap Screw	5480	7/16"-14 x 2" Cap Screw
5436	1/4"-20 x 3/4" Cap Screw	5488	1/2"-13 x 1-1/2" Cap Screw
5438	1/4"-20 x 1" Cap Screw	5490	1/2"-13 x 2" Cap Screw
5439	1/4"-20 x 1-1/4" Cap Screw	5491	1/2"-13 x 2-1/2" Cap Screw
5440	1/4"-20 x 1-1/2" Cap Screw	5492	1/2"-13 x 3" Cap Screw
5442	1/4"-20 x 2" Cap Screw	11925	1/4" High Alloy Lock Washer
5449	5/16"-18 x 3/4" Cap Screw	11926	5/16" High Alloy Lock Washer
5451	5/16"-18 x 1" Cap Screw	11927	3/8" High Alloy Lock Washer
5452	5/16"-18 x 1-1/4" Cap Screw	11928	7/16" High Alloy Lock Washer
5453	5/16"-18 x 1-1/2" Cap Screw	11929	1/2" High Alloy Lock Washer
5455	5/16"-18 x 2" Cap Screw	12781	1/4" High Strength SAE Washer
5463	3/8"-16 x 3/4" Cap Screw	12782	5/16" High Strength SAE Washer
5465	3/8"-16 x 1" Cap Screw	12783	3/8" High Strength SAE Washer
5466	3/8"-16 x 1-1/4" Cap Screw	12784	7/16" High Strength SAE Washer
5467	3/8"-16 x 1-1/2" Cap Screw	12785	1/2" High Strength SAE Washer
5468	3/8"-16 x 1-3/4" Cap Screw	15586	1/4"-20 Grade 5 Hex Nut
5469	3/8"-16 x 2" Cap Screw	15587	5/16"-18 Grade 5 Hex Nut
5471	3/8"-16 x 2-1/2" Cap Screw	15588	3/8"-16 Grade 5 Hex Nut
5476	7/16"-14 x 1" Cap Screw	15589	7/16"-14 Grade 5 Hex Nut
5478	7/16"-14 x 1-1/2" Cap Screw	15590	1/2"-13 Grade 5 Hex Nut

1030 & 1031

Grade 8 U.S. (Coarse Thread) Fastener Assortments. Contains 1 box each of:

9118	1/4"-20 x 1/2" Cap Screw	17499	5/8"-11 x 3-1/2" Cap Screw
9119	1/4"-20 x 3/4" Cap Screw	9164	5/8"-11 x 4" Cap Screw
9120	1/4"-20 x 1" Cap Screw	11925	1/4" High Alloy Lock Washer
9122	1/4"-20 x 1-1/2" Cap Screw	11926	5/16" High Alloy Lock Washer
9128	5/16"-18 x 3/4" Cap Screw	11927	3/8" High Alloy Lock Washer
9129	5/16"-18 x 1" Cap Screw	11928	7/16" High Alloy Lock Washer
9131	5/16"-18 x 1-1/2" Cap Screw	11929	1/2" High Alloy Lock Washer
9137	3/8"-16 x 1" Cap Screw	11931	5/8" High Alloy Lock Washer
9138	3/8"-16 x 1-1/4" Cap Screw	12781	1/4" High Strength SAE Washer
9139	3/8"-16 x 1-1/2" Cap Screw	12782	5/16" High Strength SAE Washer
9140	3/8"-16 x 2" Cap Screw	12783	3/8" High Strength SAE Washer
9141	3/8"-16 x 2-1/2" Cap Screw	12784	7/16" High Strength SAE Washer
9146	7/16"-14 x 1-1/2" Cap Screw	12785	1/2" High Strength SAE Washer
9147	7/16"-14 x 2" Cap Screw	12787	5/8" High Strength SAE Washer
9153	1/2"-13 x 1-1/2" Cap Screw	15640	1/4"-20 Grade 8 Hex Nut
9155	1/2"-13 x 2" Cap Screw	15641	5/16"-18 Grade 8 Hex Nut
9156	1/2"-13 x 2-1/2" Cap Screw	15642	3/8"-16 Grade 8 Hex Nut
9157	1/2"-13 x 3" Cap Screw	15643	7/16"-14 Grade 8 Hex Nut
9161	5/8"-11 x 2" Cap Screw	15644	1/2"-13 Grade 8 Hex Nut
9163	5/8"-11 x 3" Cap Screw	15645	5/8"-11 Grade 8 Hex Nut

1040 & 1041

Metric Fastener (Regular Pitch) Assortments. Contains 1 box each of:

14584	6mm-1.00 x 10mm Cap Screw (DIN 933)	14434	10mm-1.50 x 40mm Cap Screw (DIN 931)
14407	6mm-1.00 x 12mm Cap Screw (DIN 933)	14435	10mm-1.50 x 45mm Cap Screw (DIN 931)
14408	6mm-1.00 x 16mm Cap Screw (DIN 933)	14436	10mm-1.50 x 50mm Cap Screw (DIN 931)
14409	6mm-1.00 x 20mm Cap Screw (DIN 933)	14440	12mm-1.75 x 25mm Cap Screw (DIN 933)
14410	6mm-1.00 x 25mm Cap Screw (DIN 933)	14441	12mm-1.75 x 30mm Cap Screw (DIN 933)
14411	6mm-1.00 x 30mm Cap Screw (DIN 931)	14442	12mm-1.75 x 35mm Cap Screw (DIN 933)
14412	6mm-1.00 x 35mm Cap Screw (DIN 931)	14443	12mm-1.75 x 40mm Cap Screw (DIN 933)
14413	6mm-1.00 x 40mm Cap Screw (DIN 931)	14445	12mm-1.75 x 50mm Cap Screw (DIN 931)
14419	8mm-1.25 x 16mm Cap Screw (DIN 933)	14450	6mm-1.00 Hex Nut (DIN 934)
14420	8mm-1.25 x 20mm Cap Screw (DIN 933)	14452	8mm-1.25 Hex Nut (DIN 934)
14421	8mm-1.25 x 25mm Cap Screw (DIN 933)	14454	10mm-1.50 Hex Nut (DIN 934)
14422	8mm-1.25 x 30mm Cap Screw (DIN 933)	14455	12mm-1.75 Hex Nut (DIN 934)
14423	8mm-1.25 x 35mm Cap Screw (DIN 931)	10579	6mm Flat Washer (DIN 125)
14424	8mm-1.25 x 40mm Cap Screw (DIN 931)	10581	8mm Flat Washer (DIN 125)
14425	8mm-1.25 x 45mm Cap Screw (DIN 931)	10582	10mm Flat Washer (DIN 125)
14426	8mm-1.25 x 50mm Cap Screw (DIN 931)	10583	12mm Flat Washer (DIN 125)
14430	10mm-1.50 x 20mm Cap Screw (DIN 933)	10586	6mm Lock Washer (DIN 127)
14431	10mm-1.50 x 25mm Cap Screw (DIN 933)	10588	8mm Lock Washer (DIN 127)
14432	10mm-1.50 x 30mm Cap Screw (DIN 933)	10589	10mm Lock Washer (DIN 127)
14433	10mm-1.50 x 35mm Cap Screw (DIN 933)	10590	12mm Lock Washer (DIN 127)

1042 & 1043

Metric Fastener (Regular Pitch & Fine Pitch) Assortments. Contains 1 box each of:

Cap Screw			Hex Nut		
14583	5mm-.8 x 12mm	(DIN 933)	14449	5mm-.8	(DIN 934)
14403	5mm-.8 x 16mm	(DIN 933)	14450	6mm-1.0	(DIN 934)
14404	5mm-.8 x 20mm	(DIN 933)	14452	8mm-1.25	(DIN 934)
14405	5mm-.8 x 25mm	(DIN 933)	14454	10mm-1.5	(DIN 934)
14406	5mm-.8 x 30mm	(DIN 933)	14455	12mm-1.75	(DIN 934)
15512	5mm-.8 x 40mm	(DIN 933)			
14584	6mm-1.0 x 10mm	(DIN 933)	Flat Washer		
14407	6mm-1.0 x 12mm	(DIN 933)	10578	5mm	(DIN 125)
14408	6mm-1.0 x 16mm	(DIN 933)	10579	6mm	(DIN 125)
14409	6mm-1.0 x 20mm	(DIN 933)	10581	8mm	(DIN 125)
14410	6mm-1.0 x 25mm	(DIN 933)	10582	10mm	(DIN 125)
14411	6mm-1.0 x 30mm	(DIN 931)	10583	12mm	(DIN 125)
14412	6mm-1.0 x 35mm	(DIN 931)			
14413	6mm-1.0 x 40mm	(DIN 931)	Lock Washer		
14585	6mm-1.0 x 50mm	(DIN 931)	10585	5mm	(DIN 127)
14588	8mm-1.25 x 12mm	(DIN 933)	10586	6mm	(DIN 127)
14419	8mm-1.25 x 16mm	(DIN 933)	10588	8mm	(DIN 127)
14420	8mm-1.25 x 20mm	(DIN 933)	10589	10mm	(DIN 127)
14421	8mm-1.25 x 25mm	(DIN 933)	10590	12mm	(DIN 127)
14422	8mm-1.25 x 30mm	(DIN 933)			
14423	8mm-1.25 x 35mm	(DIN 931)	Fine Cap Screw		
14424	8mm-1.25 x 40mm	(DIN 931)	11257	8mm-1.0 x 25mm	(DIN 961)
14425	8mm-1.25 x 45mm	(DIN 931)	14604	8mm-1.0 x 50mm	(DIN 960)
14426	8mm-1.25 x 50mm	(DIN 931)	14605	10mm-1.25 x 20mm	(DIN 961)
14428	8mm-1.25 x 60mm	(DIN 931)	11265	10mm-1.25 x 25mm	(DIN 961)
14429	8mm-1.25 x 70mm	(DIN 933)	11266	10mm-1.25 x 30mm	(DIN 961)
14589	8mm-1.25 x 75mm	(DIN 931)	11267	10mm-1.25 x 35mm	(DIN 961)
14430	10mm-1.5 x 20mm	(DIN 933)	11268	10mm-1.25 x 40mm	(DIN 961)
14431	10mm-1.5 x 25mm	(DIN 933)	11269	10mm-1.25 x 50mm	(DIN 961)
14432	10mm-1.5 x 30mm	(DIN 933)	14606	10mm-1.25 x 60mm	(DIN 961)
14433	10mm-1.5 x 35mm	(DIN 933)	11262	10mm-1.0 x 30mm	(DIN 961)
14434	10mm-1.5 x 40mm	(DIN 931)	11264	10mm-1.0 x 50mm	(DIN 961)
14435	10mm-1.5 x 45mm	(DIN 931)			
14436	10mm-1.5 x 50mm	(DIN 931)	Fine Pitch Hex Nut		
14438	10mm-1.5 x 60mm	(DIN 931)	14453	8mm-1.0	(DIN 934)
14439	10mm-1.5 x 70mm	(DIN 931)	14457	10mm-1.25	(DIN 934)
14440	12mm-1.75 x 25mm	(DIN 933)	14456	10mm-1.0	(DIN 934)
14441	12mm-1.75 x 30mm	(DIN 933)			
14442	12mm-1.75 x 35mm	(DIN 933)			
14443	12mm-1.75 x 40mm	(DIN 933)			
14445	12mm-1.75 x 50mm	(DIN 931)			
14446	12mm-1.75 x 60mm	(DIN 931)			
14447	12mm-1.75 x 70mm	(DIN 931)			

"6000" SERIES SMALL DRAWER FIX-KITS

Photos not actual size

Auveco offers more than 40 prepackaged Fix-Kits in the 6000 series small drawer.

Each drawer measures 13-5/16" wide x 9-1/4" deep x 2" high.

Printed lid labels identify the correct Auveco part number for ordering refills.

"6000" Series Small Drawer Fix-Kit Numeric Listing

Refer to contents listing on following pages



Auveco Part No.	Description
6004	Special Tapping Screws
6043	Thread Cutting & Washer Lock Nuts
6062	Plug Buttons
6116	Internal & External Retaining Rings
6123	E-Type Retaining Ring
6128▲	Grease Fittings
6166	Body & Fender Shims
6178	O.E.M. Electrical Terminals
6187▲	Metric Grease Fittings

▲WARNING: Reproductive Harm & Cancer
www.P65Warnings.ca.gov

6043 Fix-Kit

Washer Lock Nuts & Thread Cutting Nuts
16 Varieties - 1235 Pieces



Auveco Part No.	Size
-----------------	------

2554	#6-32
2555	#8-32
2556	#10-32
2557	#10-24
2560	#12-24
2561	1/4"-20
2562	1/4"-20
2895	1/8" Stud
2896	3/16" Stud
2897	1/4" Stud
3403	1/8" Stud
3404	3/16" Stud
3405	1/4" Stud
8855	5/32" Stud
10733	5/16" Stud
12253	5mm Stud

6123 Fix-Kit

E-Type & Reinforced E-Type Rings
Groove Required
24 Varieties - 1500 Pieces



Auveco Part No.	Shaft Diameter	Type
8824	1/16"	E-Type
8825	3/32"	E-Type
8836	3/32"	Reinforced E
3165	1/8"	Reinforced E
8826	1/8"	E-Type
3166	3/16"	Reinforced E
8827	3/16"	E-Type
3167	1/4"	Reinforced E
8828	1/4"	E-Type
3628	5/16"	Reinforced E
3824	5/16"	E-Type
5600	3/8"	Reinforced E
8829	3/8"	E-Type
2672	7/16"	Reinforced E
8830	7/16"	E-Type
8837	1/2"	Reinforced E
5602	1/2"	E-Type
5601	9/16"	Reinforced E
5603	5/8"	E-Type
8831	3/4"	E-Type
8832	7/8"	E-Type
8833	1"	E-Type
8834	1-3/16"	E-Type
8835	1-3/8"	E-Type

"6000" SERIES SMALL DRAWER FIX-KITS

Photos not actual size



6116 Fix-Kit

Basic Internal & External Rings
Zinc Plated
24 Varieties - 1000 Pieces



Auveco Part No.

Shaft Diameter

Internal Type	
8688	1/4"
8689	5/16"
8690	3/8"
8691	7/16"
8692	1/2"
8693	9/16"
8694	5/8"
8695	3/4"
8696	7/8"
8697	1"
8698	1-1/8"
8699	1-1/4"
External Type	
8701	1/4"
8702	5/16"
8703	3/8"
8704	7/16"
8705	1/2"
8706	9/16"
8707	5/8"
8708	3/4"
8709	7/8"
8710	1"
8711	1-1/8"
8712	1-1/4"



6187 Fix-Kit

Metric Grease Fittings
12 Varieties - 165 Pieces

⚠ WARNING: Reproductive Harm & Cancer
www.P65Warnings.ca.gov

Auveco Part No.

Size

11097	6mm-1.00, Straight
11775	6mm-1.00, 45°
11776	6mm-1.00, 90°
11098	8mm-1.00, Straight
11777	8mm-1.00, 45°
11099	8mm-1.00, 90°
11778	8mm-1.25, Straight
11779	8mm-1.25, 45°
11780	8mm-1.25, 90°
11100	10mm-1.00, Straight
15067	10mm-1.00, 45°
11101	10mm-1.00, 90°



6166 Fix-Kit

Body and Fender Shims
Zinc Plated
4 Varieties - 400 Pieces

Auveco Part No.

Size

Slot

2452	1-3/4" x 1-1/4" x 1/16" Thick	1/2"
2453	1-3/4" x 1-1/4" x 1/8" Thick	1/2"
3155	1-1/4" x 1-1/8" x 1/16" Thick	3/8"
3156	1-1/4" x 1-1/8" x 1/8" Thick	3/8"



6178 Fix-Kit

O.E.M. Electrical
Terminals & Tools
GM, Ford & Chrysler
24 Varieties - 149 Pieces

Contains Following Part No.

8774	8776	11948	14153	14154	14462	14880	14881
14882	14883	14884	14885	14887	14888	14889	14892
15497	15498	15499	15504	15935	16004	20815	20816



6128 Fix-Kit

Grease Fittings
12 Varieties - 145 Pieces

⚠ WARNING: Reproductive Harm & Cancer
www.P65Warnings.ca.gov

Auveco Part No.	Size	Type
9257	1/4" -28	Thread, Straight (Short)
9258	1/4" -28	Thread, Straight (Long)
9259	1/4" -28	Thread, Straight (Extra Long)
9260	1/4" -28	Thread, 45°
9261	1/4" -28	Thread, 90°
9262	1/8" Pipe	Thread, Straight
9264	1/8" Pipe	Thread, 45°
9265	1/8" Pipe	Thread, 65°-1/2
9266	1/8" Pipe	Thread, 90°
9267	1/8" Pipe	Thread, Straight (Extra Long)
15060	3/16"	Drive Fit, Straight
15066	1/8" Pipe	Thread, Straight (Self-Tapping)



6062 Fix-Kit

Plug Buttons
Stainless Steel
9 Varieties - 270 Pieces

Auveco Part No.

Hole Size

3750	1/4"
3751	3/8"
3752	1/2"
3753*	5/8"
3754	3/4"
3755*	7/8"
3756*	1"
10231	1-1/4"
10232	1-1/2"

* Stainless

LARGE DRAWER FIX-KIT

Photos not actual size

3-96R

*Photo not actual size



Empty 2-Drawer Cabinet with Roller Bearings
 Holds 2 Large Drawers
 20" Wide x 15-3/4" Deep x 8" High
 Finish: Light Green Enamel
 Drawer Size: 18" Wide x 12" Deep x 3" High
 Replaces Auveco No. 3-96

UNIT PACKAGE: 1



4-96

Cabinet & 4 Empty Large Drawers
 24 Compartment Drawers with Locking Latches
 20" Wide x 15-3/4" Deep x 14-1/2" High
 Finish: Light Green Enamel
 Drawer Size: 18" Wide x 12" Deep x 3" High

2-96

Empty Cabinet. Holds 4 Large Drawers



B-3

Base for 2-96,
 3-96 & 4-96
 Raises unit 15" off floor for easier bottom drawer use
 Finish: Light Green Enamel

UNIT PACKAGE: 1

Empty Drawers

(18" Wide x 12" Deep x 3" High)
 With Locking Latches:

- 1-912: 12 Compartment
- 1-916: 16 Compartment
- 1-920: 20 Compartment
- 1-924: 24 Compartment

1-932: 32 Compartment



Empty Plastic Tray Inserts

1-916INSERT: 16 Compartment for Drawer 1-916

UNIT PACKAGE: 1 case per insert

Only available in Master Case of 4 - Not sold separately.



1-900

Steel with Locking Latch

18 x 12 x 3
 Adjustable
 Compartment
 Empty Drawer with
 3 Vertical &
 3 Horizontal
 Dividers

UNIT PACKAGE: 1



1-901

Steel with Locking Latch

18 x 12 x 3
 Adjustable
 Compartment
 Empty Drawer
 with 9 dividers

UNIT PACKAGE: 1

"6500" SERIES LARGE DRAWER FIX-KITS

Photos not actual size



Auveco offers more than 46 prepackaged Fix-Kits in the 6500 series large drawer.

Each drawer measures 18" wide x 12" deep x 3" high.

Each drawer's compartment is designed to hold the entire contents of one or more standard Auveco unit packages.

Printed lid labels identify the correct Auveco part number for ordering refills.

"6500" Series Large Drawer Fix-Kit Numeric Listing

Refer to contents listing on following pages

Auveco Part No.	Description
6505	O-Rings
6506	Cotter Pins
6507	Internal & External Retaining Rings
6508	E-Type
6511	Grease Fittings
6519	GM Xmas Tree Retainers
6520	Ford Xmas Tree Retainers
6522	Xmas Tree Retainers
6523	Tee Connectors & Rubber Caps
6536	Teks® Tapping Screws
6539	Phillips Pan Head Machine Screws & Nuts
6540	Metric Body Bolts & Nuts

Auveco Part No.	Description
6542	GM Ford & Chrysler Push-Type Retainers
6543	O.E.M. Terminals & Tools
6544	Krimp & Seal Terminals
6548	Honda & Acura Retainers & Retaining Clips
6549	Honda & Acura Push-Type Retainers
6551	Toyota & Lexus Retainers & Retaining Clips
6552	Toyota & Lexus Push-Type Retainers
6553	Oil Drain Plugs & Gaskets
6554	J.I.S. Hex Flange Bolts & Spin Lock Nuts
6557	Metal Rivets
6559	Weather Pack
6560	Halogen Lamp Harness Connectors



6539 Fix-Kit

Phillips Pan Head Machine Screws & Nuts
Zinc Plated
12 Varieties of Screws
4 Varieties of Nuts
2160 Pieces

Auveco Part No.	Size
Hex Nut	
728	#8-32
729	#10-32
730	#10-24
733	1/4"-20
Screw	
15381	#8-32 x 1/2"
15382	#8-32 x 3/4"
15383	#8-32 x 1"
15387	#10-24 x 1/2"
15388	#10-24 x 3/4"
15389	#10-24 x 1"
15393	#10-32 x 1/2"
15394	#10-32 x 3/4"
15395	#10-32 x 1"
15398	1/4"-20 x 1/2"
15399	1/4"-20 x 3/4"
15400	1/4"-20 x 1"



6536 Fix-Kit

Teks® Self-Drilling Screws
Phillips Pan Head
Hex Washer Head
Zinc Plated
16 Varieties - 365 Pieces



Auveco Part No.	Size	Head
9605	#8 x 1/2"	Pan
9606	#8 x 3/4"	Pan
9607	#10 x 1/2"	Pan
9608	#10 x 3/4"	Pan
11905	#12 x 1"	Pan
9611	#8 x 1/2"	Hex
9612	#8 x 3/4"	Hex
9613	#10 x 1/2"	Hex
9614	#10 x 5/8"	Hex
9615	#10 x 3/4"	Hex
9616	#10 x 1"	Hex
11911	#12 x 1"	Hex
9620	#14 x 3/4"	Hex
11914	#14 x 1"	Hex
11915	#14 x 1-1/4"	Hex
11916	#14 x 1-1/2"	Hex

"6500" SERIES LARGE DRAWER FIX-KITS

Photos not actual size



6540 Fix-Kit

Metric Body Bolts & Nuts
10 Varieties of Bolts
5 Varieties of Extruded U-Nuts
3 Varieties of Free Spinning Washer Nuts
2 Varieties of Hex Flange Nuts
254 Pieces

⚠ WARNING: Reproductive Harm & Cancer
www.P65Warnings.ca.gov

Auveco Part No.	Size	Type
12693	M6-1.0 x 20mm	Bolt
12324	M6-1.0 x 20mm	Bolt
12160	M6-1.0 x 22mm	Bolt
12065	M6-1.0 x 25mm	Bolt
12066	M6-1.0 x 25mm	Bolt
12335	M6-1.0 x 28mm	Bolt
17388	M8-1.25 x 20mm	Bolt
13613	M8-1.25 x 25mm	Bolt
13614	M8-1.25 x 30mm	Bolt
11641	M10-1.50 x 40mm	Bolt
11644	M8-1.25	Hex Flange Nut
11645	M10-1.5	Hex Flange Nut
12595	M6-1.0	Free Spin Washer Nut
15329	M6-1.0	Free Spin Washer Nut
15335	M8-1.25	Free Spin Washer Nut
12669	M6-1.0	Extruded U-Nut
12575	M6-1.0	Extruded U-Nut
11630	M8-1.25	Extruded U-Nut
11629	M8-1.25	Extruded U-Nut
11631	M10-1.5	Extruded U-Nut



6554 Fix-Kit

J.I.S. Hex Flange Bolts
& Spin Lock Nuts
21 Varieties - 322 Pieces

Auveco Part No.

Size

Bolts	
17315	M6-1.0 x 12mm
17316	M6-1.0 x 16mm
18807	M6-1.0 x 20mm
21048	M6-1.0 x 25mm
18808	M6-1.0 x 30mm
18809	M6-1.0 x 40mm
18980	M8-1.25 x 12mm
17387	M8-1.25 x 16mm
17388	M8-1.25 x 20mm
21051	M8-1.25 x 25mm
17389	M8-1.25 x 30mm
21052	M8-1.25 x 35mm
17390	M8-1.25 x 40mm
21053	M8-1.25 x 45mm
17188	M10-1.25 x 16mm
17189	M10-1.25 x 20mm
21054	M10-1.25 x 25mm
17190	M10-1.25 x 30mm
21055	M10-1.25 x 35mm
17191	M10-1.25 x 40mm
21056	M10-1.25 x 45mm
Nut	
16769	M6-1.0
16830	M8-1.25
16470	M10-1.25



6508 Fix-Kit

E-Type & E-Type Reinforced Rings
Groove Required
24 Varieties - 1500 Pieces



Auveco Part No.	Shaft Diameter	Type
8824	1/16"	E-Type
8825	3/32"	E-Type
8836	3/32"	Reinforced E
3165	1/8"	Reinforced E
8826	1/8"	E-Type
3166	3/16"	Reinforced E
8827	3/16"	E-Type
3167	1/4"	Reinforced E
8828	1/4"	E-Type
3628	5/16"	Reinforced E
3824	5/16"	E-Type
5600	3/8"	Reinforced E
8829	3/8"	E-Type
2672	7/16"	Reinforced E
8830	7/16"	E-Type
8837	1/2"	Reinforced E
5602	1/2"	E-Type
5601	9/16"	Reinforced E
5603	5/8"	E-Type
8831	3/4"	E-Type
8832	7/8"	E-Type
8833	1"	E-Type
8834	1-3/16"	E-Type
8835	1-3/8"	E-Type



6506 Fix-Kit

Hammerlock Cotter Pins
Bright Zinc Chromate
16 Varieties - 1500 Pieces

⚠ WARNING: Reproductive Harm & Cancer www.P65Warnings.ca.gov

Auveco Part No.	Size
8477	1/16" x 1/2"
8478	1/16" x 3/4"
8479	1/16" x 1"
8480	1/16" x 1-1/2"
8481	3/32" x 3/4"
8482	3/32" x 1"
8484	3/32" x 1-1/2"
8485	3/32" x 2"
8486	1/8" x 1"
8487	1/8" x 1-1/4"
8488	1/8" x 1-1/2"
8490	1/8" x 2"
8491	1/8" x 2-1/2"
8492	5/32" x 1"
8493	5/32" x 1-1/2"
8494	5/32" x 2"

"6500" SERIES LARGE DRAWER FIX-KITS

Photos not actual size



6523 Fix-Kit

Nylon Connectors & Rubber Caps
24 Varieties - 320 Sizes

Auveco Part No.	Size	Type
Nylon Connectors		
12929	1/8" x 1/8"	Straight
12930	1/8" x 3/16"	Straight
12936	1/8" x 1/4"	Straight
12937	3/16" x 3/16"	Straight
12935	1/4" x 3/16"	Straight
12931	1/4" x 1/4"	Straight
12946	5/16" x 5/16"	Straight
12923	1/8" x 1/8" x 1/8"	Tee
12916	1/8" x 1/8" x 3/16"	Tee
12926	3/16" x 1/8" x 3/16"	Tee
12918	3/16" x 3/16" x 3/16"	Tee
12919	1/4" x 3/16" x 3/16"	Tee
11738	1/4" x 3/16" x 1/4"	Tee
12921	3/8" x 1/4" x 3/8"	Tee
12920	5/16" x 5/16" x 5/16"	Tee
12927	3/16" x 3/16" x 3/16"	Y
12943	1/4" x 1/4" x 1/4"	Y
12932	3/16" x 3/16"	Elbow
12939	3/16"	Cross
Rubber Caps		
12209	For 1/8" O.D. Tube	
4440	For 3/16" O.D. Tube	
4439	For 1/4" O.D. Tube	
12907	For 5/16" O.D. Tube	
12210	For 3/8" O.D. Tube	

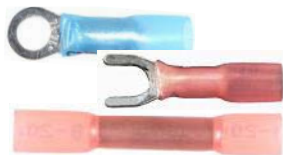

6544 Fix-Kit

Krimp & Seal Terminals
Featuring 3 - 1 Ratio Heat Shrink Tubing
24 Varieties - 204 Pieces

Auveco Part No.	Description
13656	Ring Type, 22-18 Gauge
13657	Ring Type, 22-18 Gauge
13658	Spade Type, 22-18 Gauge
13659	Butt Conn., 22-18 Gauge
13660	Female Q.C., 22-18 Gauge
13661	Male Q.C., 22-18 Gauge
13662	Ring Type, 16-14 Gauge
13663	Ring Type, 16-14 Gauge
13664	Ring Type, 16-14 Gauge
13665	Ring Type, 16-14 Gauge
13666	Ring Type, 16-14 Gauge
13669	Butt Conn., 16-14 Gauge
13670	Female Q.C., 16-14 Gauge
13671	Male Q.C., 16-14 Gauge
13672	Female Q.C., 16-14 Gauge
13673	Male, Q.C., 16-14 Gauge
13674	Ring Type, 12-10 Gauge
13675	Ring Type, 12-10 Gauge
13676	Ring Type, 12-10 Gauge
13678	Butt Conn., 12-10 Gauge
13679	Female Q.C., 12-10 Gauge
13680	Male Q.C., 12-10 Gauge
13681	Female Plug, 16-14 Gauge
13682	Male Plug, 16-14 Gauge

WARNING: ALL ITEMS ON PAGE Reproductive Risk & Cancer www.P65Warnings.ca.gov



6560 Fix-Kit

Halogen Lamps
16 Varieties - 52 Pieces

Auveco Part No.	Description
23229	Hi Temp Connector
23230	Hi Temp Connector
23231	Hi Temp Connector
23232	Hi Temp Connector
14918	Headlight Socket Standard Connector
16175	Headlight Socket Standard Connector
16174	Headlight Socket Low Beam Standard Connector
23209	Standard Connector
23234	Hi Temp Connector
23233	Hi Temp Connector
23016	Standard Connector
16694	Cornering & Fog Light Socket Standard Connector
21210	Universal Headlight Harness Connector
23142	Standard Connector
21490	Fog & Front Lights, Power Steering & Oil Pressure Switch Standard Connector
22425	Headlight Standard Connector



6543 Fix-Kit

O.E.M. Electrical
Terminals & Tools
GM, Ford & Chrysler
24 Varieties - 263 Pieces

Contains Following Part No.							
8774	8776	14150	14151	14152	14462	14880	14881
14883	14884	14885	14892	15497	15498	15499	15504
15937	15948	15955	18324	18325	18326	20583	20618



6559 Fix-Kit

Weather Pack
25 Varieties
40 Pieces

Auveco Part No.	Type
14150	Male Terminal: 20 - 18 ga.
14151	Female Terminal: 20 - 18 ga.
14152	Cable Seal
14462	Extractor Tool
15937	Female Terminal: 16 - 14 ga.
15948	Male Terminal: 16 - 14 ga.
15949	Single Cavity Shroud
15950	Single Cavity Tower
15951	Double Cavity Shroud
15952	Double Cavity Tower
15953	Triple Cavity Shroud
15954	Triple Cavity Tower
15955	Silicone Cavity Tower
18145	4 Cavity Flat Tower
18146	4 Cavity Flat Shroud
18147	4 Cavity Square Tower
18148	4 Cavity Square Shroud
18149	5 Cavity Round Tower
18150	5 Cavity Round Shroud
18151	6 Cavity Flat Tower
18152	6 Cavity Flat Shroud
18324	Female Terminal: 12 ga.
18325	Male Terminal: 12 ga.
18326	Cable Seal
20618	Cable Seal

"6500" SERIES LARGE DRAWER FIX-KITS

Photos not actual size



6553 Fix-Kit

Oil Drain Plugs & Gaskets
24 Varieties
55 Pieces

Auveco Part No.	Size
14196	1/2"-20
18373	1/2"-20
19130	1/2"-20
19365	1/2"-20, Magnetic
15527	M12-1.25
19588	M12-1.25
14677	M12-1.75
18023	M12-1.75
18374	M12-1.75
20347	M12-1.75
21047	M12-1.75
18024	M14-1.25
14678	M14-1.5
16308	M14-1.5
18025	M14-1.5
18375	M14-1.5
19141	M14-1.5
19279	M14-1.5
19620	M14-1.5 Single Oversize
19773	M14-1.5
20426	M14-1.5
15528	M16.4-1.33
15529	M18-1.5
15530	M20-1.5



6511 Fix-Kit

Grease Fittings
12 Varieties - 145 Pieces



WARNING: Reproductive Harm & Cancer
www.P65Warnings.ca.gov

Auveco Part No.	Type
9257	1/4" - 28 Thread, Straight (Short)
9258	1/4" - 28 Thread, Straight (Long)
9259	1/4" - 28 Thread, Straight (Extra Long)
9260	1/4" - 28 Thread - 45°
9261	1/4" - 28 Thread - 90°
9262	1/8" Pipe Thread - Straight
9264	1/8" Pipe Thread - 45°
9265	1/8" Pipe Thread - 65°
9266	1/8" Pipe Thread - 90°
9267	1/8" Pipe Thread, Straight (Extra Long)
15060	3/16" Drive Fit, Straight
15066	1/8" Pipe, Straight (Self-Tapping)

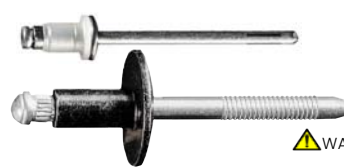

6557 Fix-Kit

Metal Specialty Rivets
24 Varieties - 624 Pieces

WARNING: Reproductive Harm & Cancer
www.P65Warnings.ca.gov

Auveco Part No.	Grip
1/8" (3.2mm) Diameter	
20788	3/64" - 1/8"
20627	3/64" - 3/16"
16834	1/8" - 3/16"
8931	3/16" - 1/4"
17615	3/16" - 3/8"
5/32" (4mm) Diameter	
18461	3/64" - 1/4"
20629	3/64" - 1/4"
20971	3/64" - 9/32"
19376	1/8" - 11/32"
17006	1/4" - 3/8"
3/16" (4.8mm) Diameter	
16864	3/64" - 11/32"
20741	3/64" - 23/64"
17121	5/64" - 15/64"
8311	1/8" - 1/4"
17410	3/8" - 1/2"
14127	3/8" - 1/2"
1/4" (6.4mm) Diameter	
16837	1/32" - 9/64"
12653	3/32" - 1/8"
18167	3/32" - 9/64"
12652	1/8" - 1/4"
12655	9/64" - 3/16"
17639	3/16" - 3/8"
8313	1/4" - 3/8"
16838	33/64" - 19/32"



6505 Fix-Kit

Rubber O-Rings
20 Varieties - 300 Pieces

Auveco Part No.	Inner Diameter	Outer Diameter
4305	1/8"	1/4"
4306	5/32"	9/32"
4307	3/16"	5/16"
4308	7/32"	11/32"
4309	1/4"	3/8"
4310	5/16"	7/16"
4311	3/8"	1/2"
4312	3/8"	9/16"
4313	7/16"	5/8"
4314	1/2"	11/16"
4315	9/16"	3/4"
4316	5/8"	13/16"
4317	11/16"	7/8"
4318	3/4"	15/16"
4319	3/4"	1"
4320	13/16"	1-1/16"
4321	7/8"	1-1/8"
4322	15/16"	1-3/16"
4323	1"	1-1/4"
4324	1-1/16"	1-5/16"

"6500" SERIES LARGE DRAWER FIX-KITS

Photos not actual size



6519 Fix-Kit

"Xmas Tree" Retainers
GM

12 Varieties - 500 Pieces

Contains Following Part No.			
10621	10831	11146	11678
11796	12137	12731	12737
12766	15970	16818	17664



6549 Fix-Kit

Honda & Acura
Push-Type Retainers
24 Varieties - 254 Pieces

Contains Following Part No.						
14696	14697	1600	1678	17057	1714	17144
17267	17379	18119	19118	19140	19231	19233
19239	19416	19453	20247	20352	20564	20608
	20986	21173	21297			



6522 Fix-Kit

"Xmas Tree" Retainers
GM, Ford & Chrysler

12 Varieties - 550 Pieces

Contains Following Part No.			
10831	11146	11796	12137
2565	12737	12766	12909
16818	17339	17612	17664



6551 Fix-Kit

Toyota & Lexus
Retainers
& Retaining Clips
24 Varieties - 361 Pieces

Contains Following Part No.							
14269	14736	14737	14738	15709	18297	18692	18842
18844	18876	18878	19112	19113	19210	19257	19729
19749	19842	20437	20443	20633	20757	20758	21102



6520 Fix-Kit

"Xmas Tree" Retainers
Ford

12 Varieties - 465 Pieces

Contains Following Part No.			
10831	11136	11146	11351
11671	12565	12571	12909
14757	17339	17664	20192



6552 Fix-Kit

Toyota & Lexus
Push-Type Retainers
24 Varieties - 229 Pieces

Contains Following Part No.							
14260	16784	17162	17439	18270	18873	18888	19140
19416	19552	19739	20335	20349	20577	20869	20908
20931	20955	21010	21011	21103	21123	21201	21294



6542 Fix-Kit

GM, Ford & Chrysler
Push-Type Retainers
11 Varieties - 325 Pieces

Contains Following Part No.			
20826	20880	20888	20889
20988	20989	20990	20991
20992	20993	20994	

6548 Fix-Kit



Honda & Acura
Retainers & Retaining
Clips
24 Varieties - 404 Pieces

Contains Following Part No.							
14289	14291	4328	15998	16775	16776	16779	17205
18114	18294	18746	18877	19114	19116	19145	19171
19470	19506	19682	20334	20609	20610	20882	21107

"6900" SERIES QUIK-SELECT II ASSORTMENTS
Photos not actual size



Looking to provide more variety of coverage and be sure that there is enough product to finish the job, Quik-Select II is your answer.

Auveco's Quik-Select II features a polypropylene box that's larger than our 6800 series Quik-Select assortments. It also has a larger variety of parts in each assortment and a greater number of each part per compartment.

The assortments come in 12, 18 and 24 compartment, translucent, durable polypropylene boxes. Box lid labels have O.E.M. numbers, sizes, product pictures, code I28 barcodes and Auveco part numbers for ordering refills.

⚠ WARNING: ALL 6900 SERIES KITS Reproductive Harm & Cancer
www.P65Warnings.ca.gov

"6900" Series Quik-Select II Numeric Listing
Refer to contents listing on following pages

Auveco Part No.	Description
6901	GM Retainers
6902	Ford Retainers
6903	Chrysler Retainers
6904	GM Push-Type Retainers
6905	Ford Push-Type Retainers
6906	Chrysler Push-Type Retainers
6907	GM Nylon Nuts
6908	Ford Nylon Nuts
6910	Toyota & Lexus Retainers & Retaining Clips
6912	Nissan & Infiniti Retainers & Retaining Clips
6913	Toyota & Lexus Push-Type Retainers
6914	Honda & Acura Push-Type Retainers
6915	Nissan & Infiniti Push-Type Retainers
6916	Toyota & Lexus Nylon Nuts & Screw Grommets
6917	Honda & Acura Nylon Nuts & Screw Grommets
6919	GM, Ford & Chrysler Push-Type Retainers
6920	Black Tapping Screws
6921	Teks® Screws
6923	Extruded U-Nuts

Auveco Part No.	Description
6924	Washer Lock Nuts, Thread Cutting Nuts, Push-On & Pushnut Retainers
6930	Nylon Connectors
6931	Oil Drain Plug Gaskets
6933	Rubber Grommets
6934	Door Lock Rod Clips
6938	Weatherstrip & Trim Panel Retainers
6942	Ford F-150 Clips & Fasteners
6943	Splash Shield
6944	Single Head Retainers
6945	License Plate Screws
6946	Engine Cover Clips & Fasteners
6947	Copper Battery Lugs
6948	Crystal Clear Krimp & Seal Terminals
6949	Self-Piercing Rivets
6950	Ford Transit Clips & Fasteners (Rear)
6951	Ford Transit Clips & Fasteners (Front)
6952	GM Express/Savana Van Clips & Fasteners
6953	Nissan NV Van Clips & Fasteners
6954	Mercedes Sprinter Clips & Fasteners
6955	Tesla Clips & Fasteners

Empty Compartment Boxes



Translucent Durable Polypropylene Boxes with Locking Tabs
 13-1/16" Wide x 8-13/16" Deep x 2-1/4" High

12 Compartment Box
 69-12: **UNIT PACKAGE: 1**

18 Compartment Box
 69-18: **UNIT PACKAGE: 1**

24 Compartment Box
 69-24: **UNIT PACKAGE: 1**

Quik-Select II Rack



69-RACK

Empty Cabinet: Holds 5 Quik-Select II Assortments.
 13-1/2" Wide x 9-1/8" Deep x 13-1/4" High
 Finish: Gray Enamel
 Keyhole slots are furnished for wall mounting.
 A handle is provided and bolt holes permits stacking.
UNIT PACKAGE: 1

"6900" SERIES QUIK-SELECT II ASSORTMENTS

Photos not actual size



6920

Black Tapping Screws
24 Varieties - 490 Pieces

Auveco
Part No.

Size

Black Oxide Phillips Oval Head

12897	#4 x 1"
12796	#6 x 3/4"
10162	#8 x 1/2" with #6 HD
10164	#8 x 3/4" with #6 HD
10165	#8 x 3/4"
10166	#8 x 1" with #6 HD
10167	#8 x 1"

Black Oxide Phillips Pan Head

11917	#6 x 1/2"
10180	#8 x 1/2"
10181	#8 x 3/4"
10182	#8 x 1"
12799	#8 x 1-1/2"
11921	#10 x 1/2"
11922	#10 x 3/4"
11923	#10 x 1"

Black E-Coat Phillips Flat Washer Head

12213	#8 x 1/2"
12214	#8 x 5/8"
12215	#8 x 3/4"
12216	#8 x 1"
12217	#8 x 1-1/4"
12218	#8 x 1-1/2"
12953	#10 x 3/4"
12954	#10 x 1"

Black Phosphate Phillips Pan Head Sems®

12820	#8 x 3/4"
-------	-----------



6923

Extruded U-Nuts
18 Varieties - 125 Pieces

Auveco
Part No.

Size

Center of
Hole to Edge

10048	#8-32	3/8"
15677	#10-24	15/32"
8359	1/4"-20	17/32"
10051	1/4"-20	25/32"
10053	5/16"-18	9/16"
8814	5/16"-18	27/32"
10054	3/8"-16	3/4"
10055	3/8"-16	1-1/8"
11625	M4-.7	13.5mm
11626	M5-.8	15.8mm
16846	M6-1.0	12mm
16842	M6-1.0	13.5mm
12669	M6-1.0	13.5mm
12575	M6-1.0	19.5mm
11628	M6.3-1.0	13.5mm
11629	M8-1.25	14.5mm
11630	M8-1.25	20mm
11631	M10-1.5	19mm



6921

Teks® Screws
18 Varieties - 520 Pieces

Auveco
Part No.

Size



Phillips Pan Head

9605	#8 x 1/2"
9606	#8 x 3/4"
9608	#10 x 3/4"

Hex Washer Head

9611	#8 x 1/2"
9612	#8 x 3/4"
9613	#10 x 1/2"
9615	#10 x 3/4"
9616	#10 x 1"
11911	#12 x 1"
11914	#14 x 1"

Specialty Screws

12095	#8 x 1/2"
15172	#8 x 1/2"
15774	#8 x 1/2"
17460	#8 x 3/4"
17650	#8 x 3/4"
18261	M4.2-1.41 x 16mm
15775	M4.2-1.41 x 20mm
19006	M4.2-1.41 x 25mm



6924

Washer Lock Nuts,
Thread Cutting Nuts,
Push-On Retainers &
Pushnut Bolt Retainers
24 Varieties - 489 Pieces

Auveco
Part No.

Size

Thread Cutting Nuts

12253	5mm Stud Size
3403	1/8" Stud Size
3404	3/16" Stud Size
2896	3/16" Stud Size
2897	1/4" Stud Size
3405	1/4" Stud Size
10733	5/16" Stud Size

Washer Lock Nuts

2557	#10-24	1/2 O.D.
2558	#10-24	3/4 O.D.

Push-On Retainers

8863	1/8" Stud Size
8864	5/32" Stud Size
8865	3/16" Stud Size
8868	1/4" Stud Size
8869	5/16" Stud Size
10374	3/8" Stud Size

Pushnut Bolt Retainers

10086	1/4" Bolt Size
10087	5/16" Bolt Size
9297	3/8" Bolt Size
9299	1/2" Bolt Size
12122	M5-.8 Bolt Size
12123	M6-1.0 Bolt Size
12125	M8-1.25 Bolt Size
12127	M12-1.75 Bolt Size
14980	M14-2.0 Bolt Size

"6900" SERIES QUIK-SELECT II ASSORTMENTS

Photos not actual size



6931

Oil Drain Plug Gaskets
18 Varieties
153 Pieces



Auveco Part No.	Size	Type
8277	1/2"	Nylon
15918	1/2"	Copper
15919	9/16"	Copper
16026	1/2"	Steel & Rubber
16682	14mm	Black Fibre
16955	18mm	Aluminum
16956	14mm	Aluminum
16996	1/2"	Nylon
17261	12mm	Copper
17262	14mm	Copper
17264	18mm	Copper
17265	20mm	Copper
18299	14mm	Steel & Rubber
18665	11mm	Rubber
18726	12mm	Black Fibre
19601	12mm	Aluminum
19630	11mm	Rubber
20453	13mm	Rubber



6930

Nylon Connectors
24 Varieties - 215 Pieces

Auveco Part No.	Size	Type
10101	1/8" x 1/8"	Straight
12929	1/8" x 1/8"	Straight
12930	1/8" x 3/16"	Straight
12936	1/8" x 1/4"	Straight
10102	3/16" x 3/16"	Straight
12937	3/16" x 3/16"	Straight
10103	1/4" x 1/4"	Straight
12935	3/16" x 1/4"	Straight
12931	1/4" x 1/4"	Straight
10104	5/16" x 5/16"	Straight
12946	5/16" x 5/16"	Straight
10105	3/8" x 3/8"	Straight
12923	1/8" x 1/8" x 1/8"	Tee
10108	5/32" x 5/32" x 5/32"	Tee
12926	3/16" x 1/8" x 3/16"	Tee
10109	3/16" x 3/16" x 3/16"	Tee
12918	3/16" x 3/16" x 3/16"	Tee
12919	1/4" x 3/16" x 3/16"	Tee
10110	1/4" x 1/4" x 1/4"	Tee
12921	3/8" x 1/4" x 3/8"	Tee
12920	5/16" x 5/16" x 5/16"	Tee
11228	3/8" x 3/8" x 3/8"	Tee
12927	3/16" x 3/16" x 3/16"	Y
12932	3/16" x 3/16"	Elbow



6933

Rubber Grommets
24 Varieties - 252 Pieces

Auveco Part No.	Bore Diameter	Width
4408	1/8"	3/32"
4410	5/32"	1/16"
4413	3/16"	1/16"
4414	3/16"	3/32"
4415	3/16"	1/4"
16454	1/4"	1/16"
4417	1/4"	1/16"
4419	5/16"	1/16"
4420	5/16"	1/16"
4421	5/16"	1/8"
4422	5/16"	1/4"
4423	3/8"	1/16"
16456	3/8"	1/16"
4425	3/8"	1/16"
4426	3/8"	1/4"
4428	1/2"	3/32"
4429	1/2"	3/32"
16458	1/2"	1/8"
4430	1/2"	1/4"
4431	5/8"	1/8"
4432	5/8"	1/16"
4433	3/4"	1/16"
4434	3/4"	1/16"
4436	3/4"	1/4"



6901

GM Retainers
18 Varieties - 373 Pieces



Contains Following Part No.

10831, 1130	11146	11612	11796	12137	12731	12737
12759	12766	12992	14036	15456	15543	15970
		17664	7975			16818



6904

GM Push-Type Retainers
18 Varieties - 233 Pieces



Contains Following Part No.

12567	12757	13993	13994	13996
14010	14011	14020	14753,	4997
15044	16622	16835	17216	17222,
				8353
				19639
				9801



6902

Ford Retainers
18 Varieties - 350 Pieces



Contains Following Part No.

10831	11136	11146	11351	11612	11671	12565	12571
12909	13470	14021	14163	15479	17339	17612	17664
				19655	20192		

"6900" SERIES QUIK-SELECT II ASSORTMENTS

Photos not actual size



6903

Chrysler Retainers
18 Varieties - 338 Pieces

Contains Following Part No.

10831	11129	11136	11146	11351	11678	14921	15481
15543	16818	17004	17612	17664	17975	18033	18862
		18915	19386				



6905

Ford Push-Type Retainers
12 Varieties - 219 Pieces

Contains Following Part No.

13994	14018	14019	14020	14753	14953	14991	14992
		14994	17103	17216	18894		



6906

Chrysler Push-Type Retainers
12 Varieties - 205 Pieces

Contains Following Part No.

11699	11704	12567	13993	14016	14019	14992	16835
		17216	18030	18269	19422		



6919

GM, Ford & Chrysler
Push-Type Retainers
11 Varieties - 215 Pieces

Contains Following Part No.

20826	20880	20888	20889	20988	20989	20990	2099
		20992	20993	20994			



6942

Ford F-150 (Aluminum Body)
Clips & Fasteners
17 Varieties - 167 Pieces

Contains Following Part No.

11146	17664	19338	19801	20530	20766	20880	20889
21169	21286	21703	22023	22058	22066	22067	22154
				22180			



6934

Door Lock Rod Clips
18 Varieties - 152 Pieces



Contains Following Part No.

10262	14359	14365	14967	15518	15673	5674	15675
15759	17122	18392	18393	18926	19658	20469	20470
		20534	20535				



6914

Honda & Acura
Push-Type Retainers
18 Varieties - 163 Pieces

Contains Following Part No.

14696	14697	14698	16000	16782	17057	17143	17144
17267	17379	18119	19118	19140	19233	19239	19453
		20247	20564				



6907

GM Nylon Nuts
12 Varieties - 480 Pieces



Contains Following Part No.

3682	8435	9829	11424	11691	11719	11838	12735
		13450	13933	13960	14031		



6917

Honda & Acura
Nylon Nuts & Screw Grommets
12 Varieties - 224 Pieces



Contains Following Part No.

14255	14268	14274	1428	14288	14313	14695	17058
		18415	19454	19734	19741		



6908

Ford Nylon Nuts
12 Varieties - 310 Pieces



Contains Following Part No.

9862	11368	11841	12569	14754	14755	14756	18816
		19277	19783	20245			



6955

Tesla Clips & Fasteners
16 Varieties - 210 Pieces

Contains Following Part No.

12119	17421	19453	20349	20633	20765	21169	25112
25151	25152	25153	25179	25284	25285	25286	25287

"6900" SERIES QUIK-SELECT II ASSORTMENTS
Photos not actual size



6910
 Toyota & Lexus
 Retainers & Retaining Clips
 24 Varieties - 280 Pieces

Contains Following Part No.							
14144	14269	14270	14736	14737	14738	15707	15709
16779	18297	18692	18842	18844	18876	18878	19112
19113	19124	19210	19257	19729	19749	19842	20443



6938
 Weatherstrip &
 Trim Panel Retainers
 23 Varieties - 315 Pieces

Contains Following Part No.							
11796	12565	12992	14269	14328	14921	17669	18033
18353	18848	18877	19171	19386	19850	20563	21102
21334	21705	21707	21795	21822	22027	22107	



6912
 Nissan & Infiniti
 Retainers & Retaining Clips
 12 Varieties - 335 Pieces

Contains Following Part No.							
14349	14352	14353	14355	14356,	4723	14737	16775
16776	17237	17452	18166				



6946
 Engine Cover Clips & Fasteners
 18 Varieties - 250 Pieces

Contains Following Part No.							
16000	17216	17632	17992	19246	20755	20955	20988
21192	21294	21420	21651,	1837	22104	22182	22253
22348	22567						



6913
 Toyota & Lexus
 Push-Type Retainers
 18 Varieties - 149 Pieces

Contains Following Part No.							
14260	16784	17162	17206	17439	17988	17992	18270
18873	18888	18939	19013	19128	19140	19219	19416
		19739	20335				



6943
 Splash Shield
 23 Varieties - 185 Pieces

Contains Following Part No.							
13994	14019	14020	15543	16859	17350	17379	17664
19418	20256	20908	21173	21294	21485	21513	22180
22199	22235	22280	22352	22532	22535		



6915
 Nissan & Infiniti
 Push-Type Retainers
 18 Varieties - 179 Pieces

Contains Following Part No.							
14696	14727	16000	16725	16782	16783	16784	16843
16858	16859	17347	17472	18265	19246	19274	20327
		20348	20349				



6947
 Copper Battery Lugs
 15 Varieties - 30 Pieces

Contains Following Part No.							
22975	22976	22977	22978	22979	22980	22981	22982
22983	22984	22985	22986	22987	22988	22989	



6916
 Toyota & Lexus
 Nylon Nuts & Screw Grommets
 18 Varieties - 230 Pieces

Contains Following Part No.							
13932	14256	14258	14265	14267	14268	14271	14273
14274	14275	14277	14281	14695	19194	19721	19756
		19783	20440				



6948
 Crystal Clear Krimp & Seal
 Terminals
 18 Varieties - 64 Pieces

Contains Following Part No.							
22955	22956	22957	22958	22959	22960	22961	22963
22964	22965	22966	22967	22969	22970	22971	22972
		22973	22974				

"6900" SERIES QUIK-SELECT II ASSORTMENTS

Photos not actual size



6949
Self-Piercing Rivets
12 Varieties - 120 Pieces

Contains Following Part No.							
25135	25136	25137	25138	25139	25140	25141	25142
		25143	25144	25145	25146		



6944
Single Head Retainers
18 Varieties - 400 Pieces

Contains Following Part No.							
10831	11129	11146	11721	12137	12571	12766	12909
14032	14036	15367	15478	15480	16818	17612	17664
		18301	20366				

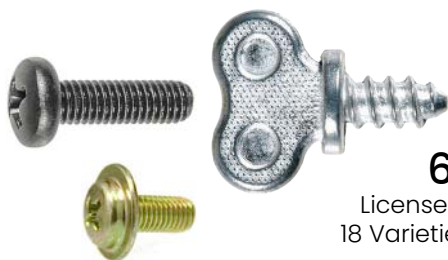

6945
License Plate Screws
18 Varieties - 630 Pieces

Contains Following Part No.							
9603	11369	14473	15170	16323	16421	16960	17098
17315	17316	17558	17980	18354	18769	18779	19777
		20446	20680				



6950
Ford Transit Clips & Fasteners
(Rear)
15 Varieties - 165 Pieces

Contains Following Part No.							
17216	20339	20360	21169	21187	21206	21241	22251
22269	22284	22818	25009	25113	25182	25189	



6951
Ford Transit Clips & Fasteners
(Front)
18 Varieties - 195 Pieces

Contains Following Part No.							
10831	12253	17216	19118	19639	20988	21247	22161
22284	22348	22359	22549	22702	22818	25009	25013
			25014	25178			



6952
GM Express/Savana Van
Clips & Fasteners
21 Varieties - 169 Pieces

Contains Following Part No.							
10831	12575	17664	19270	19317	19613	19614	20860
21047	21179	21227	21286	22453	22699	22724	22838
		22946	22947	23888	25183	25193	



6953
Nissan NV Van
Clips & Fasteners
13 Varieties - 175 Pieces

Contains Following Part No.							
18340	19205	20604	20671	21159	21192	21688	22292
22767	22834	22898	25185	25186			



6954
Mercedes Sprinter
Clips & Fasteners
19 Varieties - 259 Pieces

Contains Following Part No.							
14992	18026	20234	20253	20454	20638	20647	20909
21105	21818	21843	22309	22498	22780	25031	25214
			25215	25216	25222		

"6800" SERIES QUIK-SELECT ASSORTMENTS
Photos not actual size



Fast moving body hardware and specialty fasteners in convenient, translucent, durable polypropylene boxes.

Our Quik-Select Assortments offer popular coverage in an economical package that makes choosing the correct part fast and easy.

Assortments come in 6, 12 and 18 compartment layouts complete with O.E.M. numbers, sizes, specifications and the proper Auveco part number for ordering refills.

⚠ WARNING: ALL 6800 SERIES KITS Reproductive Harm & Cancer
www.P65Warnings.ca.gov

"6800" Series Quik-Select Numeric Listing

Refer to contents listing on following pages

Auveco Part No.	Description	Auveco Part No.	Description	Auveco Part No.	Description
6801	GM "Xmas Tree" Retainers	6830	Hair Pin Cotters	6854	Metric Specialty Screws
6802	Ford "Xmas Tree" Retainers	6831	Plastic Plug Buttons	6856	External & Internal Lock Washers
6803	Chrysler "Xmas Tree" Retainers	6834	Toyota Body Hardware	6857	Thread Cutting & Washer Lock Nuts
6804	GM Push-Type Retainers	6882	Push-Type Retainer	6858	Pushnut Bolt Retainers
6805	Ford Push-Type Retainers	6883	"Xmas Tree" Retainers	6859	Hose Connectors
6806	Nylon Rivets	6835	Rubber O-Rings	6861	Spring Pins
6807	Nylon Nuts	6836	Nylon Connectors	6862	E-Type Retaining Rings
6808	License Plate Hardware	6838	Nissan Body Hardware	6863	External & Internal Retaining Rings
6810	Sems® Screws	6839	Toyota Body Hardware	6864	Door Lock Rod Clips
6812	Black Tapping Screws	6840	Pan'l Blind Rivets	6865	Weatherstrip Retainers
6813	Teks® Screws	6841	Specialty Rivets	6866	Rubber Bumpers
6814	Body Bolts	6845	GM "Xmas Tree" Retainers	6867	Wire Loom Clips
6815	Tubular, Flat, U & J-Nuts	6846	Ford "Xmas Tree" Retainers	6868	Shims
6816	Extruded U-Nuts	6847	Chrysler "Xmas Tree" Retainers	6869	Fender Washers
6817	Washer Type Nuts & Push-On Retainers	6848	Chrome Phillips Oval Head Tapping Screws	6870	GM, Ford & Chrysler Push-Type Retainers
6818	Cotter Pins	6851	Zinc & Black Phillips Pan Head Tapping Screws	6871	Hyundai & Kia Clips & Fasteners
6825	Oil Drain Plug Gaskets	6852	Stainless Steel Tapping Screws		
6826	Rubber Vacuum Caps				
6827	Rubber Grommets				

Empty Compartment Boxes



Translucent Durable Polypropylene Boxes with Locking Tabs
 6-3/4" Wide x 11" Deep x 1-3/4" High

6 Compartment Box
 68-6: **UNIT PACKAGE: 1**

12 Compartment Box
 68-12: **UNIT PACKAGE: 1**

18 Compartment Box
 68-18: **UNIT PACKAGE: 1**
 68-118: **UNIT PACKAGE: 10**

Quik-Select Rack



68-RACK

Empty Cabinet: Holds 5 Quik-Select Assortments.
 11-1/4" Wide x 6-3/4" Deep x 10-3/4" High
 Finish: Gray Enamel
 Keyhole slots are furnished for wall mounting.
 A handle is provided and bolt holes permits stacking.

UNIT PACKAGE: 1

"6800" SERIES QUIK-SELECT ASSORTMENTS

Photos not actual size



6848

Phillips Oval Head Tapping Screws
Chrome Plated
18 Varieties - 200 Pieces

Auveco Part No.	Size
2698	#6 x 1/2"
1794	#6 x 3/4"
1796	#6 x 1"
2707	#8 x 1/2"
2027	#8 x 1/2" with #6 Head
2710	#8 x 3/4"
1799	#8 x 3/4" with #6 Head
2713	#8 x 1"
1483	#8 x 1" with #6 Head
2716	#8 x 1-1/4"
1423	#8 x 1-1/4" with #6 Head
2718	#8 x 1-1/2"
1932	#8 x 1-1/2" with #6 Head
1933	#8 x 1-3/4" with #6 Head
2728	#10 x 3/4"
1717	#10 x 3/4" with #8 Head
2731	#10 x 1"
2730	#10 x 1" with #8 Head



6812

Black Tapping Screws
18 Varieties - 312 Pieces

Auveco Part No.	Size
Black E-Coat Phillips Flat Washer Head	
12213	#8 x 1/2"
12214	#8 x 5/8"
12215	#8 x 3/4"
12216	#8 x 1"
12217	#8 x 1-1/4"
12218	#8 x 1-1/2"
12953	#10 x 3/4"
12954	#10 x 1"
Black Oxide Phillips Oval Head	
10162	#8 x 1/2" with #6 Hd.
10163	#8 x 1/2"
10164	#8 x 3/4" with #6 Hd.
10165	#8 x 3/4"
10166	#8 x 1" with #6 Hd.
10167	#8 x 1"
10168	#8 x 1-1/4" with #6 Hd.
10169	#8 x 1-1/4"
10170	#8 x 1-1/2" with #6 Hd.
10171	#8 x 1-1/2"



6850

Phillips Oval Head Tapping Screws
Black Oxide Plated
18 Varieties - 339 Pieces

Auveco Part No.	Size
12795	#6 x 1/2"
12796	#6 x 3/4"
12797	#6 x 1"
10163	#8 x 1/2"
10162	#8 x 1/2" with #6 Head
10165	#8 x 3/4"
10164	#8 x 3/4" with #6 Head
10167	#8 x 1"
10166	#8 x 1" with #6 Head
10169	#8 x 1-1/4"
10168	#8 x 1-1/4" with #6 Head
10171	#8 x 1-1/2"
10170	#8 x 1-1/2" with #6 Head
11086	#10 x 3/4"
11087	#10 x 3/4" with #8 Head
11088	#10 x 1"
11089	#10 x 1" with #8 Head
11092	#10 x 1-1/2"

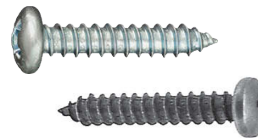

6851

Phillips Pan Head Tapping Screws
Plated
18 Varieties - 457 Pieces

Auveco Part No.	Size
Zinc	
1940	#8 x 1/2"
2365	#8 x 3/4"
3079	#8 x 1"
1943	#10 x 1/2"
2366	#10 x 3/4"
3082	#10 x 1"
2367	#12 x 3/4"
3090	#14 x 3/4"
Black Oxide	
11917	#6 x 1/2"
11918	#6 x 3/4"
10180	#8 x 1/2"
10181	#8 x 3/4"
10182	#8 x 1"
10183	#8 x 1-1/4"
12799	#8 x 1-1/2"
11921	#10 x 1/2"
11922	#10 x 3/4"
11923	#10 x 1"

"6800" SERIES QUIK-SELECT ASSORTMENTS
Photos not actual size



6810

Sem's® Screws
 Plated
 18 Varieties - 140 Pieces

Auveco Part No.	Size
Chrome	
3538	#6 x 3/4"
2771	#8 x 5/8" with #6 Hd.
2751	#8 x 3/4" with #6 Hd.
11450	#8 x 3/4", Teks
2775	#8 x 7/8" with #6 Hd., with Flush Washer
2772	#8 x 1" with #6 Hd.
2773	#8 x 1-1/4" with #6 Hd.
3465	#10 x 5/8" with #8 Hd.
3466	#10 x 3/4" with #8 Hd.
3467	#10 x 1" with #8 Hd.
Black	
11787	#8 x 5/8" with #6 Hd.
11454	#8 x 5/8", Teks
11788	#8 x 3/4" with #6 Hd.
11455	#8 x 3/4", Teks
11789	#8 x 1" with #6 Hd.
12957	#8 x 1" with #6 Hd. with Flush Washer
11791	#10 x 3/4" with #8 Hd.
11792	#10 x 1" with #8 Hd.

6813

Phillips Pan Head & Hex Washer
 Head Teks® Screws
 Zinc Plated
 18 Varieties - 127 Pieces



Auveco Part No.	Size
Pan Head	
12095	#8 x 1/2"
9605	#8 x 1/2"
9606	#8 x 3/4"
9607	#10 x 1/2"
9608	#10 x 3/4"
9609	#10 x 1"
Hex Washer Head	
9611	#8 x 1/2"
9612	#8 x 3/4"
9613	#10 x 1/2"
9614	#10 x 5/8"
9615	#10 x 3/4"
9616	#10 x 1"
11911	#12 x 1"
11913	#12 x 1-1/2"
9620	#14 x 3/4"
11914	#14 x 1"
11915	#14 x 1-1/4"
11916	#14 x 1-1/2"



6852

Stainless Steel Tapping Screws
 12 Varieties - 216 Pieces

Auveco Part No.	Size	Head
9400	#6 x 3/4"	Oval
9404	#8 x 3/4"	Oval
9405	#8 x 1"	Oval
9407	#8 x 1-1/2"	Oval
9409	#10 x 3/4"	Oval
9410	#10 x 1"	Oval
13269	#8 x 1/2"	Pan
13270	#8 x 3/4"	Pan
13271	#8 x 1"	Pan
13274	#10 x 1/2"	Pan
13275	#10 x 3/4"	Pan
13276	#10 x 1"	Pan



6808

License Plate Hardware
 12 Varieties - 171 Pieces



Contains the following Auveco part numbers:
 1313, 2472, 2625, 3182, 5228, 5278, 8250, 8427,
 8435, 9603, 11370, 11719 & 14473.



6814

Hex Head Body Bolts
 12 Varieties - 101 Pieces

Auveco Part No.	Size
11320	5/16"-18 x 1"
12693	M6-1.0 x 20mm
12324	M6-1.0 x 20mm
12160	M6-1.0 x 22mm
12065	M6-1.0 x 25mm
12066	M6-1.0 x 25mm
12323	M6-1.0 x 25mm
12335	M6-1.0 x 28mm
12351	M6.3-1.81 x 20mm
13613	M8-1.25 x 25mm
13614	M8-1.25 x 30mm
11640	M8-1.25 x 30mm



6854

Metric Specialty Screws
 18 Varieties - 145 Pieces

Auveco Part No.	Size
12062	M4.2-1.41 x 10mm
12739	M4.2-1.41 x 12mm
13712	M4.2-1.41 x 13mm
12741	M4.2-1.41 x 16mm
12060	M4.2-1.41 x 20mm
12738	M4.2-1.41 x 20mm
12742	M4.2-1.41 x 20mm
15373	M4.2-1.41 x 20mm
15775	M4.2-1.41 x 20mm
17459	M4.8-1.81 x 16mm
12057	M6.3-1.81 x 16mm
12351	M6.3-1.81 x 20mm
16828	M6.3-1.81 x 20mm
12339	M6.3-1.81 x 25mm
12068	M6.3-1.81 x 30mm
12354	M6.3-1.81 x 30mm
12350	M8-2.12 x 20mm

"6800" SERIES QUIK-SELECT ASSORTMENTS

Photos not actual size



6853

Specialty Screws
12 Varieties - 198 Pieces

Auveco Part No.	Size
10642	#8 x 3/8"
15037	#8 x 7/16"
2805	#8 x 7/16"
12095	#8 x 1/2"
15172	#8 x 1/2"
15774	#8 x 1/2"
2806	#8 x 5/8"
12820	#8 x 3/4"
13026	#8 x 3/4"
17650	#8 x 3/4"
13709	#10 x 3/4"
16589	#10 x 3/4"



6858

Pushnut Bolt Retainers
18 Varieties - 314 Pieces



Auveco Part No.	Size
16851	#6 (9/64")
10085	#8 (5/32")
16852	#10 (3/16")
10086	1/4"
10087	5/16"
9297	3/8"
9298	7/16"
9299	1/2"
12122	M5-0.8
12123	M6-1.0
14980	M6-1.0
12124	M6.3-1.0
12125	M8-1.25
12259	M8-1.25
12126	M10-1.50
12260	M10-1.50
12127	M12-1.75
16980	M14-2.0



6817

Washer Type
Thread Cutting Nuts
& Push-On Retainers
18 Varieties - 385 Pieces

Auveco Part No.	Size
Thread Cutting Nuts	
12253	5mm Stud Size
3403	1/8" Stud Size
3404	3/16" Stud Size
2896	3/16" Stud Size
2897	1/4" Stud Size
3405	1/4" Stud Size
10733	5/16" Stud Size
Push-On Retainers	
8863	1/8" Stud Size
8864	5/32" Stud Size
8865	3/16" Stud Size
8868	1/4" Stud Size
Bolt Retainers	
10086	1/4" Bolt Size
10087	5/16" Bolt Size
9297	3/8" Bolt Size
12123	6mm Bolt Size
12125	8mm Bolt Size
12259	8mm Bolt Size
12126	10mm Bolt Size



6816

Extruded U-Nuts (Foldover Nuts)
12 Varieties - 70 Pieces

Auveco Part No.	Size	Center of Hole to Edge
8359	1/4" - 20	17/32"
10051	1/4" - 20	25/32"
10053	5/16" - 18	9/16"
8814	5/16" - 18	27/32"
10054	3/8" - 16	3/4"
10055	3/8" - 16	1-1/8"
12669	M6 - 1.0	13.5mm
12575	M6 - 1.0	19.5mm
11628	M6.3 - 1.0	13.5mm
11629	M8 - 1.25	14.5mm
11630	M8 - 1.25	20mm
11631	M10 - 1.5	19mm

"6800" SERIES QUIK-SELECT ASSORTMENTS
Photos not actual size



6857

Thread Cutting &
 Washer Lock Nuts
 18 Varieties - 227 Pieces



Auveco Part No.	Size
Thread Cutting Nuts	
2895	1/8" Stud Size
3403	1/8" Stud Size
8855	5/32" Stud Size
2896	3/16" Stud Size
3404	3/16" Stud Size
3405	1/4" Stud Size
2897	1/4" Stud Size
10733	5/16" Stud Size
12253	5mm Stud Size
12255	6.3mm Stud Size
15711	8mm Stud Size
Washer Lock Nuts	
2554	#6-32 Thread
2555	#8-32 Thread
2557	#10-24 Thread
2558	#10-24 Thread
2560	#12-24 Thread
2561	1/4"-20 Thread
2562	1/4"-20 Thread



6856

External & Internal
 Lock Washers
 12 Varieties - 685 Pieces



Auveco Part No.	Size
External	
5251	#8 (5/32")
5252	#10 (3/16")
5254	#14 (1/4")
5255	5/16"
5256	3/8"
5257	7/16"
Internal	
5261	#8 (5/32")
5262	#10 (3/16")
5264	#14 (1/4")
5265	5/16"
5266	3/8"
5267	7/16"



6869

Fender Washers
 12 Varieties - 155 Pieces

Auveco Part No.	Bolt Size	Outer Diameter
2007	3/16"	1/2"
1183	3/16"	3/4"
16018	3/16"	1"
16020	1/4"	1"
2333	1/4"	1-1/4"
768	5/16"	1-1/4"
17095	5/16"	1-1/4"
1700	5/16"	1-1/2"
3553	3/8"	1-1/4"
2227	3/8"	1-1/2"
1294	3/8"	1-3/4"
17094	3/8"	1-3/4"



6868

Shims - Zinc Plated
 6 Varieties - 100 Pieces

Auveco Part No.	Size	Thickness
2453	1-3/4" x 1-1/4"	1/8"
3000	2" x 1-1/2"	1/8"
3155	1-1/4" x 1-1/8"	1/16"
3156	1-1/4" x 1-1/8"	1/8"
5076	1-1/8" x 1-1/8"	1/16"
5077	1-1/8" x 1-1/8"	1/8"



6815

Tubular, Flat, J & U Nuts
 18 Varieties - 148 Pieces

Auveco Part No.	Size	Type
2595	1/8"	Tubular
10073	3/16"	Tubular
2099	1/8"	Flat
2092	#10-24	Flat
1903	1/4"-20	Flat
5586	1/4"-20	J-Nut
5589	5/16"-18	J-Nut
5170	3/8"-16	J-Nut
10666	#8	U-Nut
11292	#8	U-Nut
5197	#10-24	U-Nut
2293	1/4"-20	U-Nut
9879	#8	U-Nut
9880	#8	U-Nut
10064	#6	U-Nut
10065	#8	U-Nut
10066	#10	U-Nut
10067	#14	U-Nut



6830

Hair Pin Cotters
 6 Varieties - 73 Pieces

Auveco Part No.	Overall Length
10397	3-15/16"
11872	1-9/16"
10398	4"
10395	2-1/2"
10396	3-3/4"
10394	2-5/16"

"6800" SERIES QUIK-SELECT ASSORTMENTS

Photos not actual size



6818

Cotter Pins
Zinc Plated
18 Varieties - 570 Pieces

Auveco Part No.	Size
8477	1/16" x 1/2"
8478	1/16" x 3/4"
8479	1/16" x 1"
8480	1/16" x 1-1/2"
8481	3/32" x 3/4"
8482	3/32" x 1"
8484	3/32" x 1-1/2"
8485	3/32" x 2"
8486	1/8" x 1"
8487	1/8" x 1-1/4"
8488	1/8" x 1-1/2"
8489	1/8" x 1-3/4"
8490	1/8" x 2"
8492	5/32" x 1"
8493	5/32" x 1-1/2"
8494	5/32" x 2"
8495	3/16" x 1-1/2"
8496	3/16" x 2"



6863

External & Internal Retaining Rings
Zinc Plated
18 Varieties - 151 Pieces



Auveco Part No.	Shaft Diameter
Internal Type	
8688	1/4"
8689	5/16"
8690	3/8"
8691	7/16"
8693	9/16"
8694	5/8"
External Type	
8701	1/4"
8702	5/16"
8703	3/8"
8704	7/16"
8705	1/2"
8706	9/16"
8707	5/8"
8708	3/4"
8709	7/8"
8710	1"
8712	1-1/4"
10125	1-1/2"



6831

Plastic Plug Buttons
6 Varieties - 305 Pieces



Auveco Part No.	Size
Depressed Center Type	
9288	1/2"
9289	3/4"
Flush Type	
14923	3/8"
11746	1/2"
11747	3/4"
11749	1"



6862

E-Type Retaining Rings
12 Varieties - 343 Pieces

Auveco Part No.	Shaft Diameter
8825	3/32"
8826	1/8"
10131	5/32"
8827	3/16"
10133	7/32"
8828	1/4"
3824	5/16"
8829	3/8"
8830	7/16"
5602	1/2"
5603	5/8"
8831	3/4"



6861

Spring Pins
Zinc Plated
12 Varieties - 174 Pieces

Auveco Part No.	Size
9006	1/8" x 3/4"
9008	1/8" x 1"
9010	1/8" x 1-1/2"
9016	5/32" x 1"
9018	5/32" x 1-1/2"
9022	3/16" x 1"
9024	3/16" x 1-1/2"
9026	3/16" x 2"
9033	1/4" x 1"
9035	1/4" x 1-1/2"
9037	1/4" x 2"
9045	5/16" x 2"



6826

Rubber Vacuum Caps
6 Varieties - 121 Pieces



Auveco Part No.	Size
12209	Fits 1/8" O.D. Tube
4440	Fits 3/16" O.D. Tube
4439	Fits 1/4" O.D. Tube
12907	Fits 5/16" O.D. Tube
12210	Fits 3/8" O.D. Tube
12908	Fits 1/2" O.D. Tube



6836

Nylon Connectors
12 Varieties - 83 Pieces

Auveco Part No.	Size	Type
11738	1/4" x 1/4" x 3/16"	Tee
12918	3/16 x 3/16" x 3/16"	Tee
12919	1/4" x 3/16" x 3/16"	Tee
12920	5/16" x 5/16" x 5/16"	Tee
12921	3/8" x 3/8" x 1/4"	Tee
12923	1/8" x 1/8" x 1/8"	Tee
12926	3/16" x 3/16" x 1/8"	Tee
12929	1/8" x 1/8"	Straight
12930	1/8" x 3/16"	Straight
12931	1/4" x 1/4"	Straight
12935	1/4" x 3/16"	Straight
12937	3/16" x 3/16"	Straight

"6800" SERIES QUIK-SELECT ASSORTMENTS

Photos not actual size



6825
Oil Drain Plug Gaskets
12 Varieties
84 Pieces



Auveco Part No.	Size	Type
8277	1/2"	Nylon
15918	1/2"	Copper
15919	9/16"	Copper
16026	1/2"	Steel & Rubber
16682	14mm	Fibre
16955	18mm	Aluminum
16956	14mm	Aluminum
16996	1/2"	Nylon
18299	14mm	Steel & Rubber
18665	11mm	Rubber
18726	12mm	Fibre
19630	11mm	Rubber



6859
Hose Connectors
12 Varieties - 61 Pieces

Auveco Part No.	Size	Type
10101	1/8" x 1/8"	Straight
10102	3/16" x 3/16"	Straight
10103	1/4" x 1/4"	Straight
10104	5/16" x 5/16"	Straight
10105	3/8" x 3/8"	Straight
10106	1/4" x 3/16"	Straight
10107	3/8" x 1/4"	Straight
10697	1/8" x 1/8" x 1/8"	Tee
10108	5/32" x 5/32" x 5/32"	Tee
10109	3/16" x 3/16" x 3/16"	Tee
10110	1/4" x 1/4" x 1/4"	Tee
11228	3/8" x 3/8" x 3/8"	Tee



6867
Wire Loom Routing Clips
6 Varieties - 42 Pieces

Auveco Part No.	For Loom Size
14544	11/32" I.D., 1/2" O.D.
14545	13/32" I.D., 19/32" O.D.
14546	1/2" I.D., 11/16" O.D.
14547	3/4" I.D., 1" O.D.
16941	1" I.D., 1-9/32" O.D.
19440	1/4" I.D., 3/8" O.D.



6840
Pan'Blind Rivets
12 Varieties - 291 Pieces

Auveco Part No.	Grip	Type
1/8" Diameter		
8309	1/16"-1/8"	Aluminum
5753	3/16"-1/4"	Steel
8925	3/16"-1/4"	Aluminum
8931	3/16"-1/4"	Aluminum Large Flange
5/16"-3/8"		
8880	5/16"-3/8"	Steel
16031	5/16"-3/8"	Aluminum
16032	3/8"-1/2"	Aluminum
3/16" Diameter		
5755	1/16"-1/8"	Aluminum
8311	1/8"-1/4"	Aluminum
8301	1/4"-3/8"	Aluminum
8313	1/4"-3/8"	Aluminum Large Flange
8938	3/8"-1/2"	Aluminum



6841
Specialty Rivets
12 Varieties - 66 Pieces

Auveco Part No.	Grip	Type
1/8" Diameter		
16834	1/8"-3/16"	
17615	3/16"-3/8"	
3/16" Diameter		
16864	3/64"-11/32"	
17121	5/64"-15/64"	
14127	3/8"-1/2"	
1/4" Diameter		
11620	1/32"-9/64"	Peel-Type
12653	3/32"-1/8"	Peel-Type
18167	3/32"-9/64"	Peel-Type
12652	1/8"-1/4"	
12655	9/64"-3/16"	Peel-Type
17639	3/16"-3/8"	
11621	33/64"-19/32"	Peel-Type



6806
Nylon Rivets
12 Varieties
74 Pieces

Auveco Part No.	Diameter	Grip
13746	3/16"	1/16"-9/64"
13747	13/64"	1/16"-11/64"
13748	13/64"	1/8"-15/64"
13755	13/64"	15/64"-25/64"
14004	15/64"	11/64"-11/32"
14023	15/64"	5/32"-5/16"
18108	1/4"	5/32"-3/8"
13750	1/4"	5/32"-13/32"
13751	1/4"	5/32"-13/32"
17101	1/4"	5/16"-15/32"
13752	17/64"	3/32"-3/16"
13753	17/64"	3/32"-3/16"

"6800" SERIES QUIK-SELECT ASSORTMENTS

Photos not actual size



6827

Rubber Grommets
18 Varieties - 99 Pieces

Auveco Part No.	Bore Diameter	Width
4408	1/8"	3/32"
4410	5/32"	1/16"
4413	3/16"	1/16"
4414	3/16"	3/32"
4415	3/16"	1/4"
4417	1/4"	1/16"
4419	5/16"	1/16"
4421	5/16"	1/8"
4422	5/16"	1/4"
4423	3/8"	1/16"
4425	3/8"	1/16"
4426	3/8"	1/4"
4428	1/2"	3/32"
4430	1/2"	1/4"
4431	5/8"	1/8"
4432	5/8"	1/16"
4434	3/4"	1/16"
4436	3/4"	1/4"



6835

Buna-N Rubber O-Rings
18 Varieties - 770 Pieces

Auveco Part No.	Industry Standard	Inner Diameter	Outer Diameter
4305	006	1/8"	1/4"
4306	007	5/32"	9/32"
4307	008	3/16"	5/16"
4308	009	7/32"	11/32"
4309	010	1/4"	3/8"
4310	011	5/16"	7/16"
4311	012	3/8"	1/2"
4312	110	3/8"	9/16"
4313	111	7/16"	5/8"
4314	112	1/2"	11/16"
4315	113	9/16"	3/4"
4316	114	5/8"	13/16"
4317	115	11/16"	7/8"
4318	116	3/4"	15/16"
4319	210	3/4"	1"
4320	211	13/16"	1-1/16"
4321	212	7/8"	1-1/8"
4323	214	1"	1-1/4"



6866

Rubber Bumpers
12 Varieties
105 Pieces

Auveco Part No.	Application
4155	General Purpose
4188	Door & Quarter Glass
4233	General Purpose
4235	Hood & Fender
4237	General Purpose
4240	Door
4242	Hood, Trunk & Deck Lid
4244	General Purpose
4246	Gas Tank Lid
4249	General Purpose
4250	Glove Box Door
4280	License Plate



6801

GM "Xmas Tree" Retainers
12 Varieties - 118 Pieces

Contains Following Part No.							
10621	10831	10832	11146	11612	11678	11796	12137
		12731	12737	12766	12992.		



6802

Ford "Xmas Tree" Retainers
12 Varieties - 112 Pieces

Contains Following Part No.							
10831	11136	11351	11671	11797	12565	12571	12909
		14021	14163	17612	19655		



6803

Chrysler "Xmas Tree Retainers"
6 Varieties - 113 Pieces

Contains Following Part No.					
10831	11136	11146	11351	11678	17004



6845

GM "Xmas Tree" Retainers
11 Varieties - 118 Pieces

Contains Following Part No.							
11120	12759	13461	14032	14036	15367	15456	15669
		15970			16818	17664	



6846

Ford "Xmas Tree" Retainers
12 Varieties - 112 Pieces

Contains Following Part No.							
8853	11136	11672	13470	14757	15478	15479	15480
		17102	17339	19655	20316		



6847

Chrysler "Xmas Tree" Retainers
12 Varieties - 113 Pieces

Contains Following Part No.							
11129	11136	11675	11679	14921	15481	15543	16818
		17004	17975	18033	20316		

"6800" SERIES QUIK-SELECT ASSORTMENTS
Photos not actual size



6864
 Door Lock Rod Clips
 12 Varieties - 59 Pieces

Contains Following Part No.

14967	15518	15673	15674	15675	15759	17122	18392
18393	18926	20675					



6807
 Nylon Nuts & Grommets
 18 Varieties - 251 Pieces

Contains Following Part No.

2625	3682	8435	9829	9862	10330	11368	11691
11719	11838	11841	11855	12735	13450	13933	13960
14009	14031						



6865
 Weatherstrip Retainers
 12 Varieties - 245 Pieces

Contains Following Part No.

8853	10744	11120	11129	11612	14328	14921	17339
18033	18692	18877	19171				



6804
 GM Push-type Retainers
 12 Varieties - 76 Pieces

Contains Following Part No.

12567	12757	13993	14010	14011	14020	14753	15044
15045	17216	17222	18353				



6805
 Ford Push-Type Retainers
 6 Varieties - 68 Pieces

Contains Following Part No.

11705	14018	14019	14020	14753	18894		
-------	-------	-------	-------	-------	-------	--	--



6870
 GM, Ford & Chrysler Push-Type Retainers
 11 Varieties - 116 Pieces

Contains Following Part No.

20826	20880	20888	20889	20988	20989	20990	20991
20992	20993	20994					



6871
 Hyundai & Kia
 Clips & Fasteners
 18 Varieties - 76 Pieces

Contains Following Part No.

20543	20566	20567	20568	20680	21064	21067	21068
21070	21136	21146	21188	21244	21312	21321	21328
21378	21382						



6838
 Nissan
 Body Hardware
 12 Varieties
 58 Pieces

Contains Following Part No.

14352	14355	16775	16776	16782	16783	16843	17347
17452	17472	20327	20348				



6839
 Toyota Body Hardware
 12 Varieties - 73 Pieces

Contains Following Part No.

14144	14271	15695	16779	17206	17438	18297	18873
18888	19739	20390	20391				



6834
 Toyota
 Body Hardware
 18 Varieties - 72 Pieces

Contains Following Part No.

13932	14260	14265	14267	14268	14269	14274	14275
14276	14695	14736	14737	14738	14750	16306	16784
19194	19721						



6882
 Foreign & Domestic
 Body Hardware
 12 Varieties - 97 Pieces

Contains Following Part No.

16859	14260	14953	19801	4020	13993	20310	14011
12567	18503	15043	12757				



6883
 Domestic
 "Xmas Tree" Retainers
 12 Varieties - 97 Pieces

Contains Following Part No.

10621	11796	11678	13461	17664	10332	11146	10831
12766	12137	18301	14036				

ASSORTMENTS

All assortments come in durable translucent polypropylene boxes
Photos not actual size



19445
 GM O.E.M. Electrical Terminals
 12 Varieties
 223 Pieces

Contains Following Part No.

8774	8776	14150	14151	14152	14880	14881	14883
15497	15498	15937	15948				



21534
 Krimp and Seal Terminals
 & Connectors
 24 Varieties - 159 Pieces

Auveco Part No. Description

13656	Ring Type, 22-18 Gauge
13657	Ring Type, 22-18 Gauge
13658	Spade Type, 22-18 Gauge
13659	Butt Conn., 22-18 Gauge
13660	Female Q.C. 22-18 Gauge
13661	Male Q.C., 22-18 Gauge
13662	Ring Type, 16-14 Gauge
13663	Ring Type, 16-14 Gauge
13664	Ring Type, 16-14 Gauge
13665	Ring Type, 16-14 Gauge
13666	Ring Type, 16-14 Gauge
13669	Butt Conn., 16-14 Gauge
13670	Female Q.C., 16-14 Gauge
13671	Male Q.C., 16-14 Gauge
13672	Female Q.C., 16-14 Gauge
13673	Male, Q.C., 16-14 Gauge
13674	Ring Type, 12-10 Gauge
13675	Ring Type, 12-10 Gauge
13676	Ring Type, 12-10 Gauge
13678	Butt Conn., 12-10 Gauge
13679	Female Q.C., 12-10 Gauge
13680	Male Q.C., 12-10 Gauge
13681	Female Plug, 16-14 Gauge
13682	Male Plug, 16-14 Gauge



19443
 U.S. Grease Fittings
 Plated
 12 Varieties - 92 Pieces



Auveco Part No. Type

9257	1/4"-28, Straight (Short)
9258	1/4"-28, Straight (Long)
9259	1/4"-28, Straight (Extra-Long)
9260	1/4"-28, 45 Degree
9261	1/4"-28, 90 Degree
9262	1/8" Pipe, Straight (Short)
9267	1/8" Pipe, Straight (Long)
15066	1/8" Pipe, Straight (Self-Tapping)
9264	1/8" Pipe, 45 Degree
9265	1/8" Pipe, 65 Degree
9266	1/8" Pipe, 90 Degree
15059	1/4" Pipe, Straight



19927
 Copper Washers
 6 Varieties - 150 Pieces

Auveco Part No. Bolt Size Outer Diameter

15915	1/4"	11/16"
15913	5/16"	9/16"
15916	5/16"	3/4"
15917	3/8"	13/16"
15918	7/16"	7/8"
15919	1/2"	13/16"



19444
 Metric Grease Fittings
 Plated
 12 Varieties - 89 Pieces



Auveco Part No. Type

11097	6mm-1.00, Straight
11775	6mm-1.00, 45 Degree
11776	6mm-1.00, 90 Degree
11098	8mm-1.00, Straight
11777	8mm-1.00, 45 Degree
11099	8mm-1.00, 90 Degree
11778	8mm-1.25, Straight
11779	8mm-1.25, 45 Degree
11780	8mm-1.25, 90 Degree
11100	10mm-1.00, Straight
15067	10mm-1.00, 45 Degree
11101	10mm-1.00, 90 Degree

WARNING: ALL ASSORTMENTS Reproductive Harm & Cancer www.P65Warnings.ca.gov

"FP" 4 PACK ASSORTMENTS

All assortments come in durable translucent polypropylene boxes
Photos not actual size



The Auveco "FP" 4 pack assortments are packed in a four compartment easy open translucent polypropylene box. Each assortment contains four carefully selected items designed for the customer that requires maximum coverage for minimum investment.

⚠ WARNING: ALL FP ASSORTMENTS Reproductive Harm & Cancer
www.P65Warnings.ca.gov

"FP" 4 Pack Numeric Listing

Refer to contents listing on following pages

Auveco Part No.	Description
FP-100	Phillips Oval Head Tapping Screws, Chrome
FP-102	Phillips Oval Head Tapping Screws, Chrome
FP-104	Phillips Oval Head Tapping Screws, Chrome
FP-108	Phillips Oval Head Tapping Screws, Chrome
FP-123	Phillips Oval Head Sems® Screws, Chrome
FP-131	Hex Washer Head Tapping Screws
FP-132	Hex Washer Head Tapping Screws
FP-159	Washer Lock Nuts
FP-160	Thread Cutting Nuts
FP-163	Tubular Nuts

Auveco Part No.	Description
FP-168	J & U Nuts
FP-188	Plug Buttons
FP-252	Thread Cutting Nuts
FP-210	Universal Moulding Fasteners
FP-224	Phillips Oval Head Tapping Screws, B. Oxide
FP-232	Phillips Oval Head Sems® Screws, Phos.
FP-233	Phillips Flat Washer Head Tapping Screws, Black E-Coat
FP-247	Spring Type U-Nuts

FP-100
 Phillips Oval Head Tapping Screws
 Chrome
 150 Pieces

Auveco Part No.	Size
1794	6 x 3/4"
2698	6 x 1/2"
1796	6 x 1"
1797	6 x 1-1/4"

FP-104
 Phillips Oval Head Tapping Screws
 No. 6 Head - Chrome
 130 Pieces

Auveco Part No.	Size
2027	8 x 1/2"
1799	8 x 3/4"
1483	8 x 1"
1423	8 x 1-1/4"

FP-102
 Phillips Oval Head Tapping Screws
 Chrome
 140 Pieces

Auveco Part No.	Size
2707	8 x 1/2"
2710	8 x 3/4"
2713	8 x 1"
2716	8 x 1-1/4"

FP-108
 Phillips Oval Head Tapping Screws
 No. 8 Head - Chrome
 115 Pieces

Auveco Part No.	Size
2724	10 x 5/8"
1717	10 x 3/4"
2730	10 x 1"
2734	10 x 1-1/4"

"FP" 4 PACK ASSORTMENTS

All assortments come in durable translucent polypropylene boxes

Photos not actual size



FP-224

Phillips Oval Head
Tapping Screws
Black Oxide
245 Pieces

Auveco Part No.	Size
-----------------	------

10163	8 x 1/2"
10165	8 x 3/4"
10167	8 x 1"
10169	8 x 1-1/4"



FP-123

Phillips Oval Head Sems®
Tapping Screws
Chrome
90 Pieces

Auveco Part No.	Size
-----------------	------

2771	8 x 5/8"
2751	8 x 3/4"
2772	8 x 1"
3466	10 x 3/4"



FP-232

Phillips Oval Head Sems®
Tapping Screws
Black Phosphate
100 Pieces

Auveco Part No.	Size
-----------------	------

11788	8 x 3/4"
11789	8 x 1"
11791	10 x 3/4"
11792	10 x 1"



FP-233

Phillips Flat Washer Head
Tapping Screws
Black E-Coat
220 Pieces

Auveco Part No.	Size
-----------------	------

12213	8 x 1/2"
12214	8 x 5/8"
12215	8 x 3/4"
12216	8 x 1"

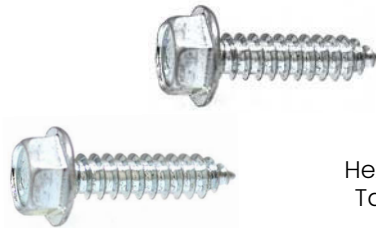

FP-131

Hex Washer Head
Tapping Screws
Zinc
165 Pieces

Auveco Part No.	Size
-----------------	------

2369	10 x 1/2"
2809	10 x 5/8"
2967	12 x 5/8"
2968	12 x 3/4"

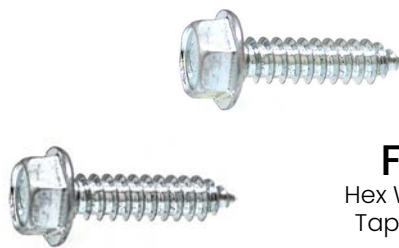

FP-132

Hex Washer Head
Tapping Screws
Zinc
75 Pieces

Auveco Part No.	Size
-----------------	------

2370	14 x 5/8"
2330	14 x 3/4"
2974	14 x 1"
2978	5/16" x 3/4"

"FP" 4 PACK ASSORTMENTS

Photos not actual size



FP-159
Washer Lock Nuts
Zinc
240 Pieces

Auveco Part No.	Thread Size	Outer Diameter
2555	8-32	15/32"
2556	10-32	1/2"
2557	10-24	1/2"
2558	10-24	3/4"



FP-160
Thread Cutting Nuts
Zinc
125 Pieces

Auveco Part No.	Stud Size	O.D.
3403	1/8"	7/16"
2895	1/8"	17/32"
2896	3/16"	5/8"
2897	1/4"	19/32"



FP-168
J and U-Type Nuts
48 Pieces

Auveco Part No.	Screw Size
1907	5/16"-10
2057	#14
2420	#14
2293	1/4"-20



FP-163
Tubular Nuts
80 Pieces

Auveco Part No.	Stud Size
2611	1/8"
11293	1/8"
3776	3/32"
2565	3/16"



FP-247
Spring U-Type Nuts
Phosphate
70 Pieces

Auveco Part No.	Screw Size
10064	#6
10065	#8
10066	#10
10067	#14



FP-171
Fender Washers
Zinc Plated
200 Pieces

Auveco Part No.	Bolt Size	Outer Diameter
1183	3/16"	3/4"
2333	1/4"	1-1/4"
768	5/16"	1-1/4"
3553	3/8"	1-1/4"



FP-210
Universal Moulding
Fasteners with Nuts
18 Moulding Fasteners & 18 Hex Nuts

Contains Following Part No.
2818 2619 2752 19626

"FP" 4 PACK & O-RING ASSORTMENTS

Photos not actual size



FP-188
Plug Buttons
Nickel Plated
37 Pieces

Auveco Part No.	Hole Size
3751	3/8"
3752	1/2"
3753*	5/8"
3755*	7/8"

*Stainless



FP-252
Thread Cutting Nuts
4 Varieties, 110 Pieces

Auveco Part No.	Stud Size	Washer Diameter	Hex Size
2895	1/8"	17/32"	5/16"
2896	3/16"	5/8"	3/8"
2897	1/4"	19/32"	7/16"
8855	5/32"	9/16"	3/8"

O-RING ASSORTMENTS

WARNING: ALL O-RING ASSORTMENTS Reproductive Harm & Cancer
www.P65Warnings.ca.gov



18885
Air Conditioning Nitrile
O-Rings
For use with R134A &
R12 refrigerant
18 Varieties - 203 Pieces

Auveco Part No.	Inner Diameter	Outer Diameter	Thickness
17604	.290"	.432"	.071"
18646	3/8"	1/2"	1/16"
17605	.400"	.546"	.073"
17606	.509"	.655"	.073"
17607	.617"	.769"	.076"
18647	11/16"	13/16"	1/16"
18134	4.5mm	7.3mm	1.4mm
18135	6mm	9.6mm	1.8mm
18136	6.5mm	9.5mm	1.5mm
18137	6.6mm	10.2mm	1.8mm
18138	7.7mm	11.3mm	1.8mm
18140	10.7mm	15.5mm	2.4mm
18139	10.8mm	14.4mm	1.8mm
18141	13.3mm	18.1mm	2.4mm
18143	13.4mm	17.2mm	1.9mm
18142	14mm	17.6mm	1.8mm
18144	14.8mm	19.6mm	2.4mm
19235	13/16"	1-1/16"	1/8"



21845
Air Conditioning
O-Rings
Blue Neoprene (Teflon
Coated)
For use with R134A &
R12 Refrigerant
6 Varieties - 325 Pieces

Auveco Part No.	Industry Standard	Inner Diameter	Outer Diameter	Thickness
18533	108	1/4"	7/16"	3/32"
18534	011	5/16"	7/16"	1/16"
18536	110	3/8"	9/16"	3/32"
18537	013	7/16"	9/16"	1/16"
18539	112	1/2"	11/16"	3/32"
18543	017	11/16"	13/16"	1/16"

BUNA-N RUBBER O-RINGS

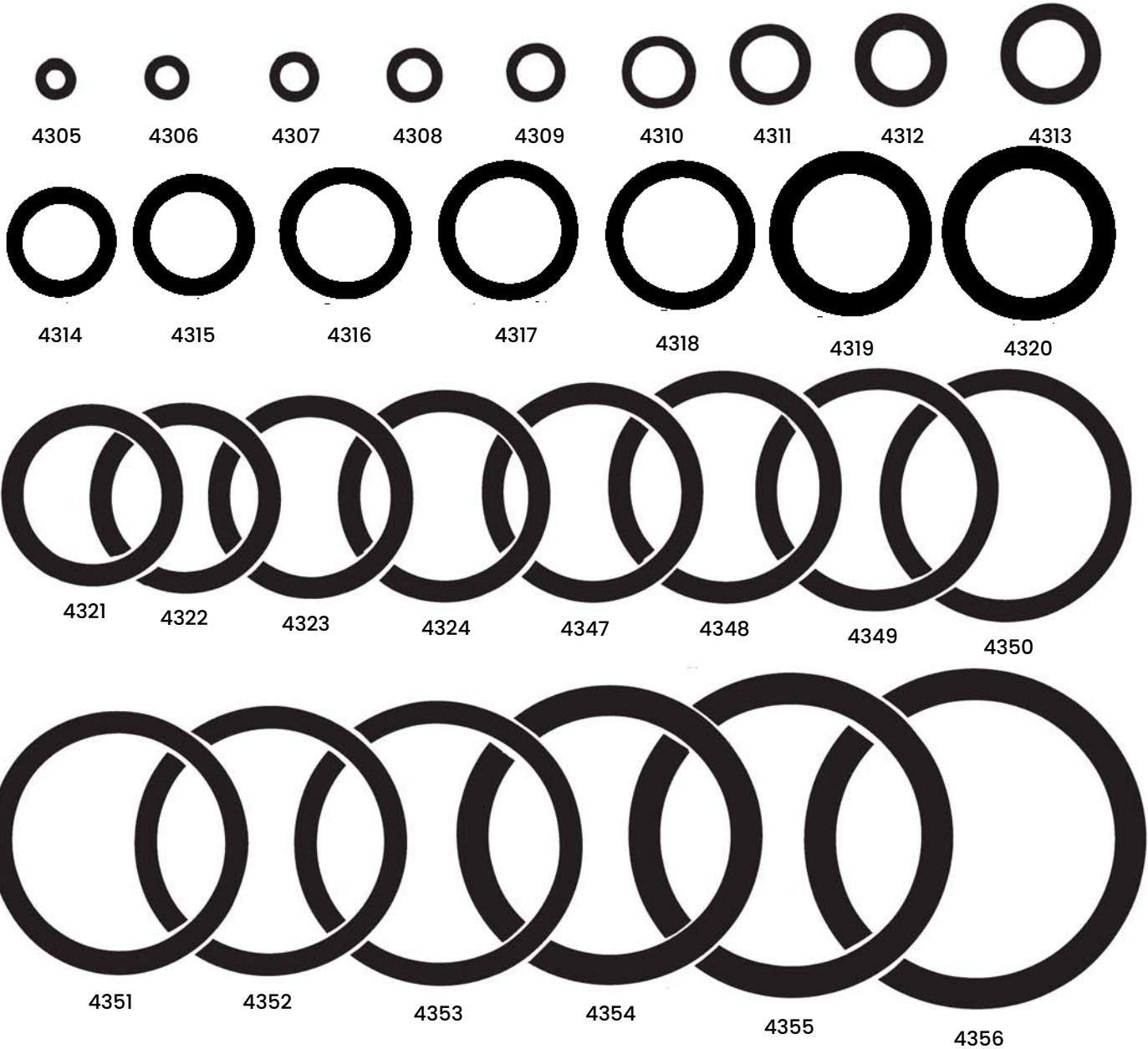

Auveco Part No.	Thickness
4305 thru 4311	1/16"
4312 thru 4318	3/32"
4319 thru 4353	1/8"
4354 thru 4356	13/64"

Temperature Rating: 70 hours at 100°C

Auveco Part No.	Ind. Std.	I.D.	O.D.	Unit Pkg.
4316	114	5/8"	13/16"	50
4317	115	11/16"	7/8"	50
4318	116	3/4"	15/16"	50
4319	210	3/4"	1"	50
4320	211	13/16"	1-1/16"	50
4321	212	7/8"	1-1/8"	50
4322	213	15/16"	1-3/16"	50
4323	214	1"	1-1/4"	50
4324	215	1-1/16"	1-5/16"	50
4347	216	1-1/8"	1-3/8"	25
4348	217	1-3/16"	1-7/16"	25
4349	218	1-1/4"	1-1/2"	25
4350	219	1-5/16"	1-9/16"	25
4351	220	1-3/8"	1-5/8"	25
4352	221	1-7/16"	1-11/16"	25
4353	222	1-1/2"	1-3/4"	25
4354	325	1-1/2"	1-7/8"	25
4355	326	1-5/8"	2"	25
4356	327	1-3/4"	2-1/8"	25

Auveco Part No.	Ind. Std.	I.D.	O.D.	Unit Pkg.
4305	006	1/8"	1/4"	50
4306	007	5/32"	9/32"	50
4307	008	3/16"	5/16"	50
4308	009	7/32"	11/32"	50
4309	010	1/4"	3/8"	50
4310	011	5/16"	7/16"	50
4311	012	3/8"	1/2"	50
4312	110	3/8"	9/16"	50
4313	111	7/16"	5/8"	50
4314	112	1/2"	11/16"	50
4315	113	9/16"	3/4"	50

WARNING: ALL ITEMS ON PAGE Reproductive Risk & Cancer www.P65Warnings.ca.gov

METRIC BUNA-N RUBBER O-RINGS

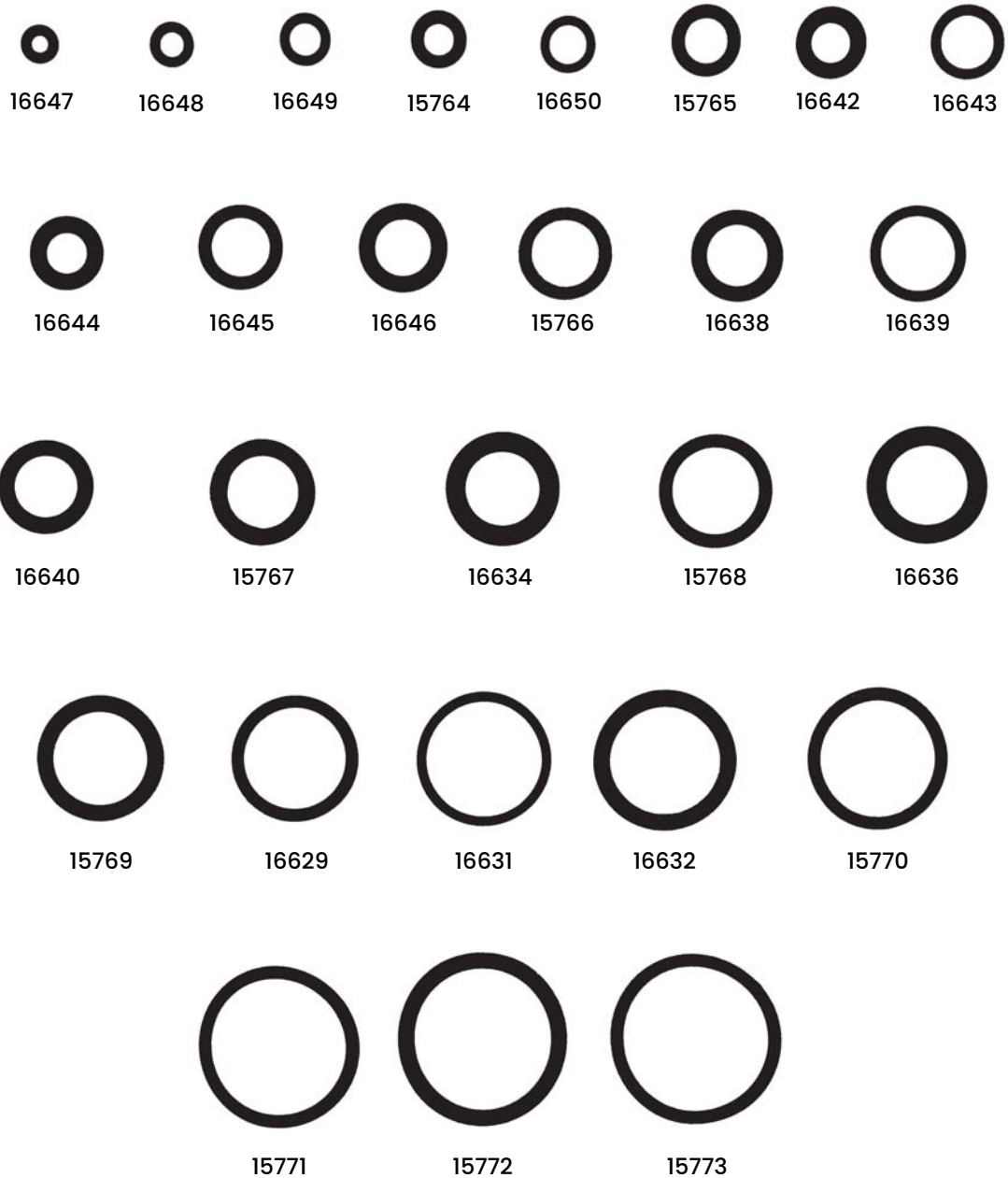

Auveco Part No.	Inner Diameter	Outer Diameter	Thickness	Unit Pkg.	Auveco Part No.	Inner Diameter	Outer Diameter	Thickness	Unit Pkg.
16648	3.1mm	6.3mm	1.6mm	50	15767	10mm	15mm	2.5mm	100
16649	4.1mm	7.3mm	1.6mm	50	15768	12mm	16mm	2mm	100
15764	4mm	8mm	2mm	100	16636	11mm	17mm	3mm	50
16650	5mm	8mm	1.5mm	50	15769	13mm	18mm	2.5mm	100
15765	6mm	10mm	2mm	100	16629	14mm	18mm	2mm	50
16642	5.3mm	10.1mm	2.4mm	50	16631	16mm	19mm	1.5mm	50
16643	7.1mm	10.3mm	1.6mm	50	16632	15mm	20mm	2.5mm	50
16644	5.6mm	10.4mm	2.4mm	50	15770	16mm	20mm	2mm	50
16645	8mm	12mm	2mm	50	15771	19mm	23mm	2mm	50
16646	7.6mm	12.4mm	2.4mm	50	15772	19mm	24mm	2.5mm	50
15766	9mm	13mm	2mm	100	15773	20mm	24mm	2mm	50
16638	8.3mm	13.1mm	2.4mm	50					
16639	10.1mm	13.3mm	1.6mm	50					

WARNING: ALL ITEMS ON PAGE Reproductive Risk & Cancer www.P65Warnings.ca.gov

O-RINGS

Air Conditioning O-Rings

For use with R12 Refrigerant only

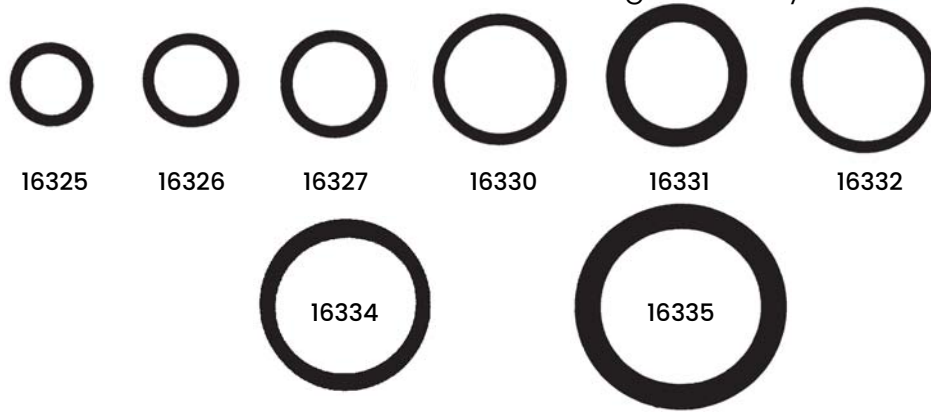

For original air conditioning systems. Not for use with R134A refrigerant.

Auveco Part No.	Ind. Std.	I.D.	O.D.	Thick-ness	Unit Pkg.
16325	011	5/16"	7/16"	1/16"	50
16326	012	3/8"	1/2"	1/16"	50
16327	013	7/16"	9/16"	1/16"	50
16330	015	9/16"	11/16"	1/16"	50

Auveco Part No.	Ind. Std.	I.D.	O.D.	Thick-ness	Unit Pkg.
16332	016	5/8"	3/4"	1/16"	50
16334	018	3/4"	7/8"	1/16"	25
16335	211	13/16"	1-1/16"	1/8"	10

Nitrile Air Conditioning O-Rings

For use with R12 & R134A Refrigerant

These O-Rings are either green or black with an orange dot.

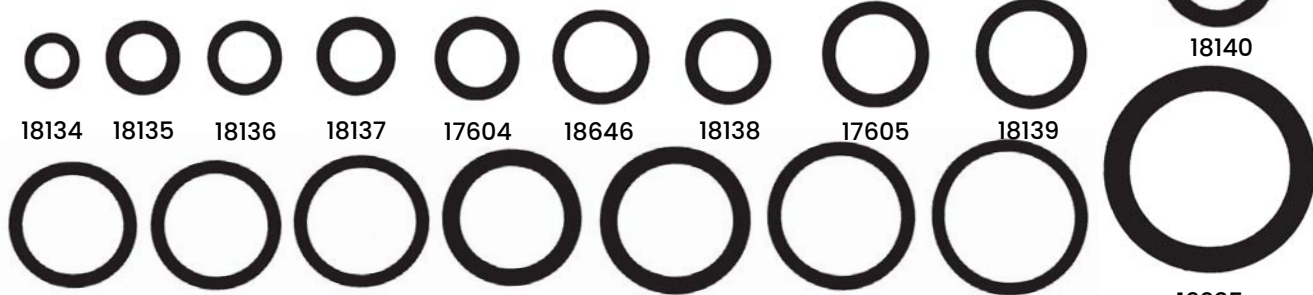

Auveco Part No.	I.D.	O.D.	Thickness	OEM No.	Unit Pkg.
18134	4.5mm	7.3mm	1.4mm	Nissan: 92472-N8200	25
18135	6mm	9.6mm	1.8mm	Nissan: 92470-N8200	25
18136	6.5mm	9.5mm	1.5mm	Toyota: 90099-14044	25
18137	6.6mm	10.2mm	1.8mm	Acura: 80873-ST7-000	25
17604	.290"	.432"	.071"	Ford: 391396	25
18138	7.7mm	11.3mm	1.8mm	Nissan: 92474-N8200	25
18646	.375"	.500"	.063"		25
17605	.400"	.546"	.073"	Ford: 391397	25
18139	10.8mm	14.4mm	1.8mm	Nissan: 92471-N8200	25
18140	10.7mm	15.5mm	2.4mm	Acura: 80872-ST7-000 Nissan: 92475-W1000	25
17606	.509"	.655"	.073"	Ford: 391304	25
18143	13.4mm	17.2mm	1.9mm	Toyota: 90099-14045	15
18142	14mm	17.6mm	1.8mm	Nissan: 92473-N8200	25
18141	13.3mm	18.1mm	2.4mm	Acura: 80871-ST7-000	25
18144	14.8mm	19.6mm	2.4mm	Nissan: 92475-W2100	15
17607	.617"	.769"	.076"	Ford: 391305	15
18647	.688"	.813"	.063"		25
19235	13/16"	1-1/16"	1/8"		10

WARNING: ALL ITEMS ON PAGE Reproductive Risk & Cancer www.P65Warnings.ca.gov

Blue Neoprene Air Conditioning O-Rings

Teflon Coated • For use with R134A & R12 Refrigerant

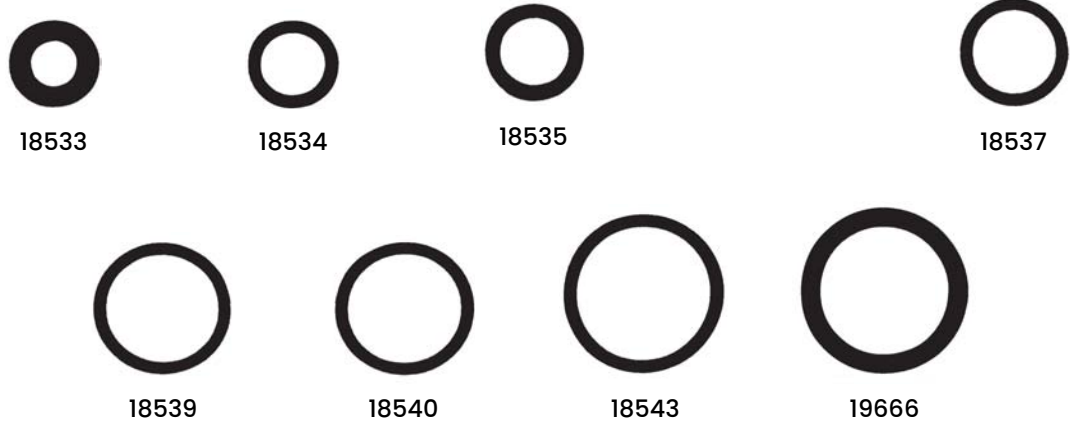

Auveco Part No.	Industry Standard	Inner Diameter	Outer Diameter	Thickness	Unit Pkg.
18533	108	1/4"	7/16"	3/32"	25
18534	011	5/16"	7/16"	1/16"	25
18537	013	7/16"	9/16"	1/16"	25
18540	015	9/16"	11/16"	1/16"	25
18543	017	11/16"	13/16"	1/16"	25
19666	115	11/16"	7/8"	3/32"	25

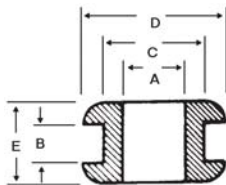

Rubber Grommet

Made of SBR Material • Durometer Hardness 60



UNIT PACKAGE: 25

Auveco Part No.	A Bore Dia.	B Groove Width	C Groove Dia.	D Outside Dia.	E Overall Thickness
24024	1/8"	1/16"	1/4"	11/32"	3/16"
4408	1/8"	3/32"	3/8"	1/2"	5/16"
4410	5/32"	1/16"	1/4"	3/8"	3/16"
4411	5/32"	3/32"	1/4"	7/16"	3/8"
4413	3/16"	1/16"	5/16"	1/2"	1/4"
4414	3/16"	3/32"	9/32"	3/8"	5/16"
4415	3/16"	1/4"	5/16"	7/16"	3/8"
16454	1/4"	1/16"	3/8"	1/2"	3/16"
4417	1/4"	1/16"	7/16"	5/8"	3/16"
4418	1/4"	1/16"	1"	1-1/4"	1/4"
4419	5/16"	1/16"	7/16"	9/16"	3/16"
4420	5/16"	1/16"	9/16"	13/16"	5/16"
16455	5/16"	1/16"	3/4"	1"	5/16"
4421	5/16"	1/8"	9/16"	13/16"	3/8"
4422	5/16"	1/4"	9/16"	13/16"	1/2"
4423	3/8"	1/16"	1/2"	11/16"	9/32"
Auveco Part No.	A Bore Dia.	B Groove Width	C Groove Dia.	D Outside Dia.	E Overall Thickness
16456	3/8"	1/16"	5/8"	7/8"	11/32"
4425	3/8"	1/16"	1"	1-1/4"	1/4"
4426	3/8"	1/4"	5/8"	7/8"	1/2"
16457	7/16"	1/16"	9/16"	3/4"	1/4"
4428	1/2"	3/32"	3/4"	31/32"	9/32"
4429	1/2"	3/32"	25/32"	1"	11/32"
24027	1/2"	1/16"	5/8"	13/16"	9/32"
16458	1/2"	1/8"	3/4"	1"	1/2"
4430	1/2"	1/4"	13/16"	1-1/16"	1/2"
4431	5/8"	1/8"	7/8"	1-1/8"	3/8"
4432	5/8"	1/16"	7/8"	1-1/8"	5/16"
4433	3/4"	1/16"	15/16"	1-1/8"	1/4"
4434	3/4"	1/16"	1-1/16"	1-3/8"	3/8"
4435	3/4"	1/16"	1-1/4"	1-5/8"	1/4"
4436	3/4"	1/4"	1-1/4"	1-5/8"	7/16"

WARNING: ALL ITEMS ON PAGE Reproductive Risk & Cancer www.P65Warnings.ca.gov

Tubeless Tire Valves



Length: 1-1/4"
Rim Hole: 29/64"
(TR413)

10184
UNIT PACKAGE: 5

10191
UNIT PACKAGE: 25

10192
UNIT PACKAGE: 100

⚠ WARNING: Reproductive Harm & Cancer www.P65Warnings.ca.gov

Replacement TPMS Rubber Snap-in Valve Stem



Auveco Part No.	Length	Rim Hole	Max Air Pressure	Unit Pkg
25121	1-1/2"	0.453" (29/64")	65 PSI	20
25122	1-1/2"	0.453" (29/64")	65 PSI	5

High Temperature, Nickel Plated Valve Core

- Replacement valve core for all types of applications including cars, trucks, buses, ATV's, golf carts, lawnmowers, trailers and more
- Suitable for use in TPMS valve stems
- Nickel Plated Brass

Auveco Part No.	Unit Pkg
25119	50
25120	25

⚠ WARNING: ALL ITEMS IN CHARGE Reproductive Harm & Cancer www.P65Warnings.ca.gov

Replacement Valve Caps

- O-Ring seal for extra firm & secure fitment onto the valve
- Applications include cars, trucks, bicycles, motorcycles, trailers, golf carts, ATV's, lawn movers and more



25123 & 25124



25125 & 25126



25127 & 25128



25129 & 25130



25131 & 25132



25147 & 25148

Auveco Part No.	Description	Unit Pkg.
25123	Grey Plastic TPMS Valve Cap with Seal	100
25124	Grey Plastic TPMS Valve Cap with Seal	25
25125	Black Long Skirted Plastic TPMS Valve Cap with Seal	100
25126	Black Long Skirted Plastic TPMS Valve Cap with Seal	25
25127*	Standard Black Replacement Valve Cap	100
25128*	Standard Black Replacement Valve Cap	25
25129	Green Plastic Valve Cap with Seal - For use with Nitrogen	100
25130	Green Plastic Valve Cap with Seal - For use with Nitrogen	25
25131	Metal Valve Cap with Chrome Finish & Seal	50
25132	Metal Valve Cap with Chrome Finish & Seal	25
25147	Plastic Valve Cap with Chrome Finish & Seal	100
25148	Plastic Valve Cap with Chrome Finish & Seal	25

* Does NOT include Seal

⚠ WARNING: ALL ITEMS IN CHART Reproductive Risk & Cancer www.P65Warnings.ca.gov



Peel back liner.



Press on clean dry surface



Photo not actual size

Peel-Bak is a light-weight closed cell sponge material. It is an easy to apply weatherstrip for auto and household use. Can also be used on boats, refrigerators or any place a weatherproof, permanent seal is required. Simple to use: Peel back the liner tape and press into place. No cement or tacking required. Surface must be clean and dry.

Thickness	Width	10 Ft. Roll Auveco Part No.	50 Ft. Roll Auveco Part No.
5/32"	3/8"	4800	4850
5/32"	1/2"	4801	4851
5/32"	5/8"	4802	
5/32"	3/4"	4803	4852
5/32"	1"	4804	4853
5/16"	3/8"		4854
5/16"	1/2"	4806	4855
5/16"	5/8"	4807	
5/16"	3/4"	4808	4856
5/16"	1"	4809	4857
7/16"	3/8"		
7/16"	1/2"	4811	4859
7/16"	3/4"	4812	4860
7/16"	1"	4813	4861

WARNING: ALL ITEMS IN CHART Cancer
www.P65Warnings.ca.gov

Exact Size Profile

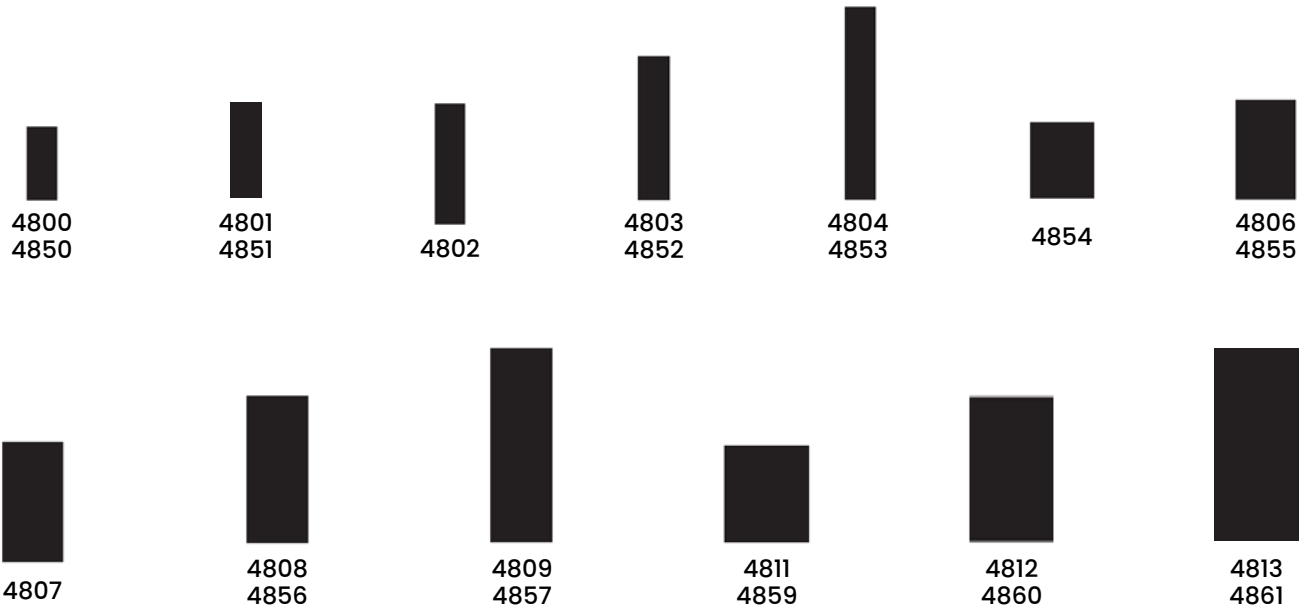

SPONGE RUBBER WEATHERSTRIPS

EPDM Closed Cell • Light Weight • Weather Resistant



16390
Door Flange Weatherstrip
GM, Ford & Chrysler Cars & Trucks
UNIT PACKAGE: 15 Ft.

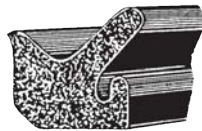

16392
Door Flange Weatherstrip
Ford 1955-On
UNIT PACKAGE: 15 Ft.



4675
Same as 16390 except for unit package quantity
UNIT PACKAGE: 50 Ft.

4745
Same as 16392 except for unit package quantity
UNIT PACKAGE: 50 Ft.



4707
Door Flange Weatherstrip
Chrysler 1954-50
Ford 1958-50
UNIT PACKAGE: 50 Ft.



4742
Trunk & Lid Weatherstrip
GM 1959 - On
Ford 1949 - On
Studebaker 1967 - 55
UNIT PACKAGE: 50 Ft.



4747
Door Inner Belt Weatherstrip
All Cars 1970-55
UNIT PACKAGE: 50 Ft.



16391
Door Flange Weatherstrip
GM: 1955 - On
UNIT PACKAGE: 15 Ft.



16395
Trunk & Rear Deck Gutter Weatherstrip
GM
UNIT PACKAGE: 15 Ft.



4703
Same as 16395 except for unit package quantity
UNIT PACKAGE: 50 Ft.

4744
Same as 16391 except for unit package quantity.
UNIT PACKAGE: 50 Ft.



4731
Door Flange Weatherstrip
GM 1954-53
Universal
UNIT PACKAGE: 50 Ft.



4743
Trunk Weatherstrip
Universal
UNIT PACKAGE: 35 Ft.



WARNING: ALL SPONGE RUBBER WEATHERSTRIPS Reproductive Risk & Cancer www.P65Warnings.ca.gov

SPONGE RUBBER WEATHERSTRIPS

EPDM Closed Cell • Light Weight • Weather Resistant



20928

Door Flange,
Trunk & Tail Gate
Weatherstrip
Hole Diameter: 3/32"
Universal



UNIT PACKAGE: 25 Ft.



16525

Door Seal Weatherstrip
GM 1963 - 55



UNIT PACKAGE: 50 Ft.



**Extruded Closed Cell
Sponge Rubber**

Will not absorb water or moisture.
Without Cement.

4740

Exact Size Profile



1/8" Thick -1-1/2" Wide

UNIT PACKAGE: 25 Ft.



**Closed Cell Half Round
Sponge Rubber**

UNIT PACKAGE: 50 Ft.

4736

1/4" Half Round



4737

3/8" Half Round



4738

1/2" Half Round



**Closed Cell Sponge
Rubber Windlace Cord**

Flexible filler for cloth covered
windlace on door, windshield
pillars and door bottoms

UNIT PACKAGE: 50 Ft.

4654

1/4" Diameter



4655

3/8" Diameter



4656

1/2" Diameter



EPDM RUBBER WEATHERSTRIP FOR GLASS

EPDM Dense Rubber

Photos not actual size



17509

Glass Thickness: 1/4"
Body Thickness: 1/16"
Self-Locking Type

UNIT PACKAGE: 50 Ft.



17513

Glass Thickness: 1/4"
Body Thickness: 1/8"
Bead Lock Type

UNIT PACKAGE: 50 Ft.



17510

Glass Thickness: 1/4"
Body Thickness: 1/8"
Self-Locking Type

UNIT PACKAGE: 50 Ft.

WARNING: ALL ITEMS ON PAGE Reproductive Risk & Cancer www.P65Warnings.ca.gov



4280

(3745361, 3762180)

License Plate Bumper
GM

UNIT PACKAGE: 25



4246

(357811)

Gas Tank Lid Rubber Bumper
Ford

UNIT PACKAGE: 25



4242

(4137121)

Trunk, Rear Deck Lid, &
Hood Bumper
GM

UNIT PACKAGE: 25



4243

(513388)

Hood to Ledge Bumper
GM

UNIT PACKAGE: 25



4265

(3711168)

Door Lock Striker Plate, Window Glass Stop
& License Plate Bumper
GM

UNIT PACKAGE: 25



4188

(4081765)

Door & Quarter Glass and
Door Opening Header Bumper
GM

UNIT PACKAGE: 25



4237

(3664645)

General Purpose
GM

UNIT PACKAGE: 25



4235

(3688811)

Hood Top Panel Side
Bumper to Fender
GM

UNIT PACKAGE: 25



4248

(16758)

General Purpose
Ford

UNIT PACKAGE: 25



4258

(352839)

General Purpose
Ford

UNIT PACKAGE: 25



4447

(7724826)

Trunk Lid Bumper
GM

UNIT PACKAGE: 10



13967

General Purpose
Outer Diameter: 1/2"
Head Height: 5/16"
Fits into 1/4" Hole
Durometer: 55-65

UNIT PACKAGE: 25



4446

(4872948)

Trunk Lid Bumper
GM

UNIT PACKAGE: 25



4264

(4564974)

Front Door Bumper
GM

UNIT PACKAGE: 25



4441

(4565591, 7637192)

Front Door Bumper
GM

UNIT PACKAGE: 25



4233

(3655015)

General Purpose
GM

UNIT PACKAGE: 25

WARNING: ALL ITEMS ON PAGE Reproductive Risk & Cancer www.P65Warnings.ca.gov



4273
(B7A-16758-A)

Hood Bumper
Ford

UNIT PACKAGE: 25



4369
(3900684, 15029828)

Pillar Bumper
GM Trucks

UNIT PACKAGE: 25



22903
(Nissan: 65829-50A00)
Black Rubber

Hood Bumper
Head Diameter: 15mm
Overall Height: 20mm
Fits into 8mm Hole
Infiniti FX35, FX45 & I35 2008 - 2002
QX56 2010 - 2004
Nissan Armada Cube, Frontier, Maxima,
Rogue, Sentra, Titan, Versa,
Versa Note & Xterra 2000 - On

UNIT PACKAGE: 25



4249
(1304225)

General Purpose
GM

UNIT PACKAGE: 25



4250
(3693292)

Glove Box Door Bumper
GM

UNIT PACKAGE: 25



4155
(16758A)

General Purpose
Ford

UNIT PACKAGE: 25



22713
(VW: 1K8-837-529)
Black Rubber

Door Bumper
Head Height: 11mm
Stem Length: 6mm
Fits into 6mm Hole
Volkswagen GTI & Golf 2014 - 2010

UNIT PACKAGE: 25



4244
(972724)

General Purpose
Chrysler

UNIT PACKAGE: 25



4204
(4023030)

General Purpose
Ford & Chrysler

UNIT PACKAGE: 25



4240
(4563173, 4565415)

Door Bumper
GM

UNIT PACKAGE: 25



4236
(3689084)

General Purpose
GM

UNIT PACKAGE: 25



4281
(4721222)

Trunk Lid Bumper
GM

UNIT PACKAGE: 25



25053
(GM: 22755704)
Black Rubber

Hood Prop Buffer
Overall Width: 20mm
Overall Height: 27mm
Fits into 11mm Slot
Chevrolet Silverado 2014 - On;
GMC Sierra 2018 - On;
Yukon 2015 - On

UNIT PACKAGE: 25



22864
(Ford: W714996-S300)
Black Rubber

License Plate Bumper
Head Height: 15mm
Outer Diameter: 15mm
Fits into 10mm Square Hole
Ford C-Max, Edge, Escape, Expedition,
Explorer, Fiesta, Focus & Fusion and
Lincoln MKX, MKZ & Navigator 2007 - On
Mercury Mariner, Milan &
Mountaineer 2011 - 2002

UNIT PACKAGE: 25

WARNING: ALL ITEMS ON PAGE Reproductive Risk & Cancer www.P65Warnings.ca.gov



23710
(1717924)

Trunk Lid Bumper
Diameter: 11/16"
Length: 3/4"
GM 1979 - On

UNIT PACKAGE 25



15453
(472450, 12338034)

Hood Bumper
Across the Flats: 1"
Diameter: 15/16"
Overall Length: 1-29/32"
GM X Cars 1980 - On

UNIT PACKAGE: 10

⚠ WARNING: Reproductive Harm & Cancer
www.P65Warnings.ca.gov

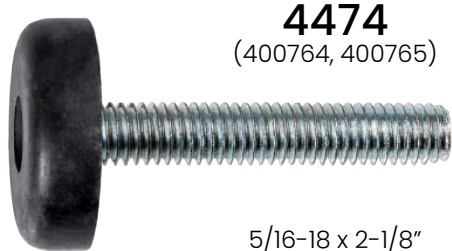

4474
(400764, 400765)

5/16-18 x 2-1/8"
Hood Adjusting Bolt & Bumper
GM

UNIT PACKAGE: 5

⚠ WARNING: Reproductive Harm & Cancer
www.P65Warnings.ca.gov



16849
(Not Supplied by O.E.M.)
Nylon

Hood Adjustment Nut
Threaded Insert: M6-1.0
Ford 1989 - On

UNIT PACKAGE: 10



16850
(Not Supplied by O.E.M.)
Zinc

M6-1.0 x 44mm
Hood Adjustment Bumper
Hex: 23mm
Ford 1989 - On

UNIT PACKAGE: 5

⚠ WARNING: Reproductive Harm & Cancer
www.P65Warnings.ca.gov



16832
(E83Z-16758-A)

Hood Adjustment Nut & Bumper
Ford 1989 - On

UNIT PACKAGE: 2 Sets

⚠ WARNING: Reproductive Harm & Cancer
www.P65Warnings.ca.gov

Belt Weatherstrips



Years	Vehicle	Application	O.E.M. Number	Auveco Part No.
1991-81	Blazer, Jimmy & Suburban	Inner-Driver Side	15569071	20797▲
1991-81	Blazer, Jimmy & Suburban	Inner-Passenger Side	15569072	20798▲
1991-73	Blazer, Jimmy & Suburban	Outer-Driver Side	14027775	20799▲
1991-73	Blazer, Jimmy & Suburban	Outer-Passenger Side	14027776	20800▲
1987-81	Pickup	Inner-Driver Side	15569071	20797▲
1987-81	Pickup	Inner-Passenger Side	15569072	20798▲
1987-73	Pickup	Outer-Driver Side	14027775	20799▲
1987-73	Pickup	Outer-Passenger Side	14027776	20800▲
1980-73	Pickup, Jimmy, Blazer & Suburban	Inner-Passenger Side	470434	20796▲



Vent Window Seals

Years	Vehicle	Application	O.E.M. Number	Auveco Part No.
1980-73	Pickup, Jimmy, Blazer & Suburban	Front Passenger Side (Vertical sold separately)	6271904	20803▲

GLASS SETTING CHANNELS

EPDM Dense Rubber

4511



For 1/8" Glass
Glass Setting Channel
Height: 11/32"
Width at Base: 1/4"
Inside Base: 1/8"

UNIT PACKAGE: 50 Ft.

4512



For 3/16" Glass
Windshield and Rear Window
Glass Setting Channel
Height: 7/16"
Width at Base: 27/64"
Inside Base: 3/16"

UNIT PACKAGE: 50 Ft.

4588



For 1/4" Glass
Windshield and Rear Window
Glass Setting Channel
Height: 9/16"
Width at Base: 7/16"
Inside Base: 1/4"

UNIT PACKAGE: 50 Ft.

Photos not actual size

Molded Dense Rubber

Tee Rubber Concave Head



UNIT PACKAGE: 50 Ft.

4531

Head: 9/32"
Height: 1"

▲WARNING: ALL ITEMS ON PAGE Reproductive Risk & Cancer www.P65Warnings.ca.gov

Rubber Caps

Special Heat Resistant EPDM Rubber

Can be used for capping lines and hoses while testing carburetors, emission control systems, vacuum lines, etc



Auveco Part No.	Fits Tube O.D.	Inside Length	Unit Pkg.
12209	1/8"	9/16"	25
4440	3/16"	9/16"	25
19000	3/16"	1-1/4"	25
4439	1/4"	9/16"	25
19001	1/4"	1-1/4"	25
19002	5/16"	9/16"	25
12907	5/16"	1-1/4"	25
12210	3/8"	31/32"	25
19003	3/8"	1-1/2"	25
12908	1/2"	11/16"	10

WARNING: ALL ITEMS IN CHART Cancer
www.P65Warnings.ca.gov

Vinyl Vacuum Caps

Can be used for capping lines and hoses while testing carburetors, emission control systems, vacuum lines, etc. Color coded for size identification.



Auveco Part No.	I.D.	Fits Tube O.D.	Color	Length	Unit Pkg.
18202	1/8"	3/16"	Blue	5/8"	50
18203	3/16"	1/4"	Red	5/8"	50
18204	1/4"	5/16"	White	5/8"	50
18205	5/16"	3/8"	Black	5/8"	50

WARNING: ALL ITEMS IN CHART Cancer
www.P65Warnings.ca.gov

Rubber Hold Down Straps with Hooks



Auveco Part No.	Length	Unit Span Range	Pkg.
4448	9"	15" to 20"	10
4449	15"	20" to 30"	10
4450	20"	30" to 40"	10
4451	31"	40" to 55"	10

WARNING: ALL ITEMS IN CHART Reproductive Risk & Cancer
www.P65Warnings.ca.gov



11298

Galvanized

3/16" x 3"
"S" Hook

Used with Auveco Rubber Hold Down Straps 4448, 4449, 4450 and 4451

UNIT PACKAGE: 50

11299

Same as 11298 except for unit package quantity

UNIT PACKAGE: 100



18979
(3767196)

**Windshield Setting Block
Lower Spacer**
Chrysler Caravan,
Voyager and Town & Country
1984 - On

UNIT PACKAGE: 15

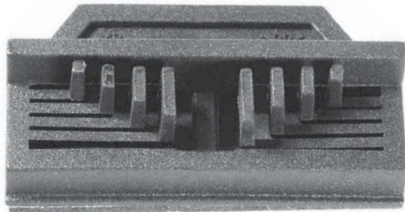

21195
(15061964)
Black Nylon

**Windshield Glass
Setting Block with
Adhesive Backing**

Overall Length: 51mm
Buick Rainier; Cadillac Escalade; Chevrolet
Avalanche, Colorado, Silverado, Suburban, Tahoe
& Trailblazer; GMC Canyon, Envoy, Sierra & Yukon;
Hummer H2 & H3 Oldsmobile Bravada and
Saab 9-7 1999 - On

UNIT PACKAGE: 10



19816
(55256967AC)
Black & Natural
Nylon

**Windshield Glass
Adjustable Setting Block**
NAGS Numbers:
DW0999 & DW1295
Dodge Dakota & Durango 1997 - On

UNIT PACKAGE: 10



19817
Black Nylon

Universal Glass Setting Block
Width: 1-3/16"
Height: 7/16"
Length: 15/16"

UNIT PACKAGE: 25

23360

Same as 19817 except for unit package quantity

UNIT PACKAGE: 50

23860
Nylon



Windshield Glass Support
5 Holes for Universal Use
GM

UNIT PACKAGE: 10

23944
(55275388AB, 55275388AC)
Nylon



Adjustable Windshield Stop Block
Dodge Pick-Up &
Grand Cherokee 1994 - On

UNIT PACKAGE: 10



3135

**Window Regulator
Roller Assembly**
Ford

UNIT PACKAGE: 25



23904

(Not Available from OEM)
Nylon

Window Regulator Roller
Use with 23905
GM 1957 - 1966
AMC 1963 - 1966

UNIT PACKAGE: 15



23905

Window Regulator Roller Rivet
Rivet for One Piece Roller
Use with 23904 (98-7885)

GM Cars 1957 - 1966
Rambler 1963 - 1966

UNIT PACKAGE: 25



23906
 (Not Available from OEM)
Window Regulator Roller Kit
 Contains: 1- Roller 23905 &
 1-Rivet 23094
 GM 1957 - 1966
 Suburban Rear Power Window
 AMC 1963 - 1965
UNIT PACKAGE: 10



23936
Window Regulator Roller Rivet
 Rivet for Two Piece Roller
 GM Cars 1957 - 1966
UNIT PACKAGE: 25



23995
Window Regulator Roller Rivet
Use with 23996 (RK-137)
 GM Most Models Prior to 1957
 GM Trucks to 1964
UNIT PACKAGE: 25



23996
Window Regulator Roller
 Inner Diameter: 0.375
 Outer Diameter: 0.730
 Groove: 0.443
 Thickness: 0.328
Use with 23995 (B-7719)
 GM Most Models Prior to 1957
 GM Trucks to 1964
UNIT PACKAGE: 25



23997
Window Regulator Roller & Rivet
 Contains: 1- Roller 23996 &
 1- Rivet 23995
 GM Passenger Cars
 Prior to 1957
 GM Trucks through 1965
UNIT PACKAGE: 25



24141
Window Regulator Arm Roller
 Ford, Lincoln, Mercury 1952 - 1958
 Ford Trucks 1952 - 1965
UNIT PACKAGE: 25



24142
 Metal
Window Regulator Roller Coil Spring
UNIT PACKAGE: 100



24143
 Metal
Window Regulator Retaining Clip
UNIT PACKAGE: 100



24144
Push Nut
 Stud: 5/16"
 Outer Diameter: 1"
 For window regulator arm stud
 Chrysler
UNIT PACKAGE: 50



2598
 (353745-S)
Window Regulator Arm to Plate Assembly Clip
 Ford
UNIT PACKAGE: 100



1267
 Lacquered
Inside Door Handle & Quarter Regulator Handle Escutcheon Tension Spring
UNIT PACKAGE: 25



2288
 Zinc
Door & Window Crank Handle Retaining Clip
 GM, Ford & Toyota
UNIT PACKAGE: 100



9886
Door & Window Crank Handle Retaining Clip
 GM
UNIT PACKAGE: 100



11
 Yellow Zinc Spring Steel
Door & Window Crank Handle Retaining Clip
 GM
UNIT PACKAGE: 100



23785
 (90520-01274)
Window Crank Handle Retaining Clip
 Toyota
UNIT PACKAGE: 50



16340

(54229-0201P)

Window Crank Handle Retaining
Clip
Nissan

UNIT PACKAGE: 100



11152

(GM: 9731301; AMC: 4005540)
White Nylon

Windshield to Panel (Lower)
Side Moulding Clip

GM 1975 - On
AMC 1975 - On

UNIT PACKAGE: 100



23872

(3936399)

Windshield Reveal
Moulding Clip
Corvette 1968 - 1975

UNIT PACKAGE: 25



9633

(7698976)

Windshield Upper &
Lower Moulding Clip
GM 1967 - On

UNIT PACKAGE: 100



9749

(7730788)

Windshield, Skylight, Quarter
& Rear Window Reveal
Moulding Clip
GM 1968 - On

UNIT PACKAGE: 50



8583

(4533699)

Rear Window Reveal Moulding Clip
GM 1965 - On

UNIT PACKAGE: 100



9275

(7634583, 8734067)

Rear Window Reveal Moulding Clip
GM 1966 - On

UNIT PACKAGE: 50

10242

Same as 9275 except for unit package quantity

UNIT PACKAGE: 100

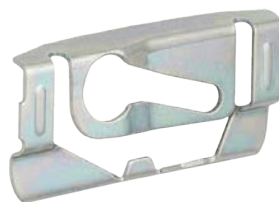

9639

(7693140)

Windshield, Skylight, Rear &
Quarter Window Reveal
Moulding Clip
GM 1966 - On

UNIT PACKAGE: 50



23679

(20113224)

Nylon

Windshield Reveal
Lower Moulding Clip

GM 1979 - On

UNIT PACKAGE: 100



23956

(8717859, 9854717)

Front Rear Window Reveal
Moulding Clip

Impala (SPT, CPE) 1969
with Vinyl Top
GM 1971 - 1990

UNIT PACKAGE: 50



11067

(9606232, 9662950,
20603072)

Windshield & Rear Window
Reveal Moulding Clip

GM 1973 - On

UNIT PACKAGE: 100



10243

(8717859)

Rear Window Reveal Moulding Clip
GM 1969 - On

UNIT PACKAGE: 100



10701

(9895598)

Windshield Reveal
Moulding Clip
GM 1971 - On

UNIT PACKAGE: 50



10630

(9808241)

Windshield & Rear Window Reveal
Moulding Clip

GM 1970 - On

UNIT PACKAGE: 50



10631

(9854717)

Windshield Reveal Moulding Clip
GM 1970 - On

UNIT PACKAGE: 50



11345

(1654047)

Nylon

Windshield & Rear Window
Reveal Moulding Clip
GM 1974 - On

UNIT PACKAGE: 100



11152

(GM: 9731301; AMC: 4005540)

White Nylon

Windshield to Panel (Lower)
Side Moulding Clip
GM 1975 - On
AMC 1975 - On

UNIT PACKAGE: 100



20232

(10287926)

Yellow Nylon

Front & Rear Door
Window Moulding Clip
Overall Length: 1-9/16"
Buick Century & Regal
and Oldsmobile Intrigue 1997 - On

UNIT PACKAGE: 25



17355

(GM: 94467458;
Isuzu: 8944674584)
Nylon

Windshield Reveal Moulding Clip
Geo Storm 1992 - On

UNIT PACKAGE: 10

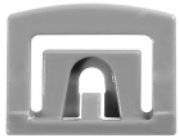

23723

(D9AZ-5403178-B)

Windshield Reveal
Moulding Clip
Ford 1979 - On

UNIT PACKAGE: 50



20263

(22599312)

Black Nylon

Front & Rear Door
Window Moulding Clip
Chevrolet Malibu, Oldsmobile
Achieva & Cutlass 1997 - On

UNIT PACKAGE: 25



2628

(4657731)

Windshield & Rear Window
Reveal Moulding Fastener
GM

UNIT PACKAGE: 100



23877

(6002615)

Windshield Reveal Moulding Clip
Chrysler 1968 - 1972

UNIT PACKAGE: 50



24145

(C5ZZ-6503178-B)

Windshield & Rear
Window Moulding Clip
Rubberless Installation
All GM models using
this type of installation
Mustang 1964 - 1965

UNIT PACKAGE: 100



24170

(6002263)

Windshield & Rear Window
Reveal Moulding Clip
For Upper & Side
Chrysler, Dodge & Plymouth 1965 - 1972

UNIT PACKAGE: 25



20276

(6003409, 6003752)

Windshield & Rear Window
Reveal Moulding Clip
Replaces Auveco 11177 & 13569
Chrysler 1974 - On

UNIT PACKAGE: 25



10622

(6002893)

Rear Window Reveal Moulding Clip
Chrysler 1971 - On

UNIT PACKAGE: 50



17151

(6004036)

Nylon

Window Reveal Moulding Clip
Chrysler LeBaron & Maserati
1987 - On

UNIT PACKAGE: 15



23582

(D1AZ-6542113-B)

Windshield & Rear Window Reveal
Moulding Clip
Ford Mercury 1965 - On
Mustang 1966 - On
AMC 1967 - 1975, Mazda 1974

UNIT PACKAGE: 100



9882

(C8AZ-63642413-A,
D1AZ-6542413-B,
D1AB-6542413-AB)

**Windshield & Rear Window
Reveal Moulding Clip**
Ford 1968 - On

UNIT PACKAGE: 100



9353

(C6AB-6242413-A)

**Rear Window
Reveal Moulding Clip**
Ford 1967 - On

UNIT PACKAGE: 100



8941

(C5ZZ-6543413-B)

**Windshield & Rear Window
Reveal Moulding Clip**
Ford 1966 - On

UNIT PACKAGE: 100



23696

(D9AZ-5403178-A)

**Windshield Top
Reveal Moulding Clip**
Ford 1979 - On

UNIT PACKAGE: 100



13564

(E3SB-6342413-AB)

**Windshield & Bakelite
Reveal Moulding Clip**
Ford 1983 - On

UNIT PACKAGE: 50



21526

(Not Available from O.E.M.)
White Nylon

Windshield Moulding Clip
Head Size: 14.5mm x 30mm
Bottom Leg Width: 26mm
Ford Flex 2009 - On

UNIT PACKAGE: 25



20424

(Not Available from O.E.M.)
White Nylon

Front Door Window Guide
Overall Length: 1-13/32"
Buick Electra, Park Ave. & Skylark; Chevrolet Malibu;
Oldsmobile Achieva, Alero, Cutlass & 98 Regency
and Pontiac Grand Am 1985 - On

UNIT PACKAGE: 5



21022

(4339372)
Black Nylon

**Window Guide
with Rivets**
Chrysler Acclaim,
GTS, Lancer, LeBaron,
Shadow, Spirit &
Sundance 1989 - On

UNIT PACKAGE: 25

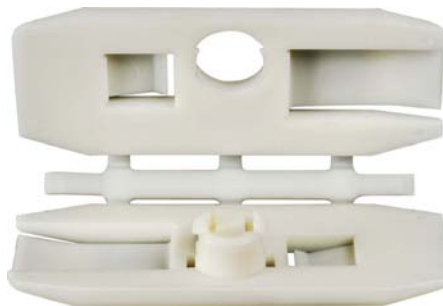

19397

(21098967)
Nylon

**Front &
Rear Door
Window Guide**
Saturn Sedan &
Wagon
1996 - On

UNIT PACKAGE: 5



15463

(12353912, 20487630, 20712176)
Nylon

Front Door Window Guide
Front of Glass (4mm Thick)
Buick Skylark & Somerset 1991-85
Chevrolet Lumina APV 1990-On; Olds Calais 1991-85;
Olds Silhouette 1990-On; Pontiac Grand Am 1991-85
Pontiac Trans Sport 1990-On

UNIT PACKAGE: 15



15466
(20160591)
Nylon

**Front Door Window Guide
Upper Part of Glass**

LeSabre 90-80 & Electra 84-On; Fleetwood Brougham & DeVille 83-On; Impala & Caprice 90-80 & Cavalier 87; Delta 88 & Custom Cruiser 90-80 & 98 Regency 84-80; Parisienne & Safari 89-81 & Sunbird 87

UNIT PACKAGE: 25



15467
(10051034, 20123070, 20328600)
Nylon

Front & Rear Door Window Guide
Electra, Estate Wagon, LeSabre & Skylark; DeVille;

Impala Wagon, Caprice & Citation; Delta 88, Custom Cruiser, 98 Regency & Omega; Catalina, Safari & Phoenix 81 - 80

UNIT PACKAGE: 25



17176
(20162174, 22543363)
Nylon

Front Door Window Guide
Buick Skyhawk, Cadillac Cimarron, Chevrolet Cavalier, Olds Firenza & Pontiac Sunbird 1982-On

UNIT PACKAGE: 25



Photo not actual size

17341
(12337898, 20747508)
Nylon

Front Door Window Guide Front of Glass

Buick Electra, LeSabre & Park Ave., Cadillac Fleetwood & DeVille, Olds 88 Royal & 98 Regency, Pontiac Bonneville 1985-On

UNIT PACKAGE: 15



23856
(115647709)
Nylon

Rear Side Door Windows Guide
GM S-10 Blazer 4 Door

UNIT PACKAGE: 15



23866
(15953718, 15985762)
Nylon

Front Door Window Guide
GM S Series Trucks 1991 - On

UNIT PACKAGE: 15



18113
(69951-12180)
Nylon with Steel Treaded Insert

Glass Mount
Thread: M6-1.0
Nissan, Ford & Imports

UNIT PACKAGE: 5



23626
(Not Available from OEM)

Door Glass to Channel Roller
Ford 1973 - On

UNIT PACKAGE: 10



23627
(Not Available from OEM)

Door Glass to Channel Attaching Kit
Ford 1978

UNIT PACKAGE: 10



19393
(FITZ-17698A)

Rear View Mirror Bracket
(Windshield Mounted)
NAGS numbers DW 1256,
1099 1169 & 1170

Fits Ford Mirrors F0TZ-17700-A & F7AZ-17700-A on
Ford & L-M Continental, Contour, Escort, Mustang,
Mystique, Sable, Taurus & Tracer 1991 - On

UNIT PACKAGE: 10



19394
(20626174)

Rear View Mirror Bracket
(Windshield Mounted)
NAGS numbers 1168, 1191, 1192,
1193, 1194, 1195,
1265, 1288 & 1299
GM 1987-On

UNIT PACKAGE: 10



17073
(20085729)
Nylon

Window Regulator Drive Block
used with Window
Regulator Tape
GM 1980 - On

UNIT PACKAGE: 25



24510

Photo not actual size
Three Stranded "Gold"
Windshield Wire
For Cutting Urethane
Windshield Seals
Length: 72'

UNIT PACKAGE: 1



19786
(Not Available from O.E.M.)
Natural Nylon

Torque Pin Kit for
Window Regulator Gear
Pin Diameter: 1/2"
Pin Length: 13/32"
Ford 1964 - On

UNIT PACKAGE: 15



16959

Photo not actual size
Piano Wire
For Cutting through Sealant on
Windshields without Gaskets
Solid not Braided Wire
1/4 Pound (approx. 160 Ft.)
Wire Diameter: .025"

UNIT PACKAGE: 1 Roll



24156
(D0VY-53234A24A)

Power Window & Tailgate Gear
7 Tooth Metal & 45 Tooth Plastic
For station wagon tailgate and
electric windows with vent glass
Ford Station Wagon 1970 - On

UNIT PACKAGE: 1

HORNS

Photos not actual size

O.E.M. Replacement Horns

19017



Domestic Vehicles - Low Note
Terminals: One/Two
Frequency (Hz): 400
Decibel Rating at 4": 125
Current Draw (Amps): 6
Power Source Volts: 12

UNIT PACKAGE: 1

19018



Domestic Vehicles - High Note
Terminals: One/Two
Frequency (Hz): 500
Decibel Rating at 4": 125
Current Draw (Amps): 6
Power Source Volts: 12

UNIT PACKAGE: 1

Riviera Air Horns & Compressor Kit

19023



Photo not actual size

The Riviera air-powered dual horns sound simultaneously and have the "European" sound. Comes complete with a 12 volt compressor, relay, tubing and mounting hardware.

UNIT PACKAGE: 1 Set

Freeway Blaster Horns ("Big Rig" Sound)

19021



Low Note
Terminals: One/Two
Frequency (Hz): 400
Decibel Rating at 4": 130
Current Draw (Amps): 6
Power Source Volts: 12

UNIT PACKAGE: 1

19022



High Note
Terminals: One/Two
Frequency (Hz): 500
Decibel Rating at 4": 130
Current Draw (Amps): 6
Power Source Volts: 12

UNIT PACKAGE: 1

Year	Make & Model	Original Equipment Replacement	Freeway Blaster (Optional)
ACURA			
12-90	All Models	*19022 & 19021	
AMC			
90-79	Alliance, Encore, Talon		19022 & 19021
90-74	All Other Models	19018 & 19017	19022 & 19021
AUDI			
12-73	All Models	*19018	*19022
BMW			
12-95	5, 7, & 9 Models	19018 & 19017	19022 & 19021
12-74	All Other Models		19022 & 19021
BUICK			
12-86	All Other Models	19022 & 19021	
96-75	Skyhawk & Skylark	*19018	*19022
CADILLAC			
12-75	All Other Models	19022 & 19021	
83-81	Cimarron	*19018	*19022
CHEVROLET			
12-76	Aveo, Beretta, Cavalier, Celebrity, Chevette, Citation, Corsica, Spectrum, Sprint & Nova	*19018	*19022
12-71	Corvette	19022 & 19021	
12-71	All Other Models	19018 & 19017	19022 & 19021
CHEVROLET LIGHT DUTY TRUCKS & VANS			
12-75	S-10	19018 & 19017	19022 & 19021
12-75	All Other Models	19022 & 19021	
CHRYSLER			
12-77	All Other Models	19018 & 19017	19022 & 19021
10-95	Sebring		19022 & 19021
97-87	LeBaron & GTS	19018	*19021
DODGE			
12-74	All Other Models	19018 & 19017	19022 & 19021
05-95	Neon		*19022
DODGE			
99-87	Charger, Lancer, Omni, Shadow, Spirit	*19018	*19022
98-74	Challenger, Colt		*19022
DODGE LIGHT DUTY TRUCKS & VANS			
12-87	Dakota, Ram, Pickup, Caravan	*19021	
12-75	All Other Models	19022 & 19021	
FORD			
12-07	Edge	19018 & 19017	19022 & 19021
12-01	Escape	19018 & 19017	19022 & 19021
12-71	Escort, Fairmont, Festiva, Focus, Maverick Mustang II, Pinto, Tempo, Contour	*19018	*19022
12-70	All Other Models	19022 & 19021	
97-77	Fiesta		19022
FORD LIGHT DUTY TRUCKS & VANS			
12-85	All Other Models	19022 & 19021	
90-75	Ranger, E 150/350 Vans, Aerostar, Economize	*19022	
GEO			
12-90	All Other Models		*19021
99-90	Storm		19022 & 19021
GMC LIGHT DUTY TRUCKS & VANS			
12-75	All Other Models	19018 & 19017	19022 & 19021
92-91	Jimmy, Sonoma	*19021	
HONDA			
12-80	Civic, Civic Del Sol		*19022
12-73	All Other Models		19022 & 19021
HYUNDAI			
12-86	All Other Models		19022 & 19021
87-84	Pony		19022
INFINITI			
12-90	All Models	19022 & 19021	
ISUZU			
12-83	Impulse, Stylus, Trooper		19022 & 19021
12-81	I Mark, Amigo, Pickup, Rodeo		*19022
JAGUAR			
12-72	All Models	19022	19021
JEEP			
12-74	Cherokee, Grand Cherokee	19022 & 19021	
12-70	CJ, DJ, Scrambler, Wrangler	*19018	*19022

Year	Make & Model	Original Equipment Replacement	Blaster (Optional)
LEXUS			
12-90	All Models	19022 & 19021	
LINCOLN-MERCURY			
12-74	All Other Models	19022 & 19021	
99-71	Capri & Capri II		*19022
99-71	Bobcat, Lynx, Zephyr, Tracer, Mystique, Topaz	*19018	*19022
MAZDA			
12-91	Navajo	19018 & 19017	19022 & 19021
12-75	All Other Models		19022 & 19021
12-71	RX-2, RX-3, Mizer, MX-3, MX-5, Protege, GLC Wagon, B2200, B2601		*19022
MAZDA TRUCK			
12-78	All Models		*19021
MERCEDES			
12-73	All Models	19022 & 19021	
MITSUBISHI			
12-83	All Models		19022 & 19021
NISSAN			
12-97	All Models	19018 & 19017	19022 & 19021
96-74	All Other Models		19022 & 19021
90-87	Pulsar		19022
NISSAN TRUCK			
12-93	Quest	19018 & 19017	19022 & 19021
12-82	All Other Models		*19021
OLDSMOBILE			
04-91	Bravada	*19017	*19021
04-98	Alero	19018 & 19017	19022 & 19021
04-74	All Other Models	19022 & 19021	*19021
89-88	Firenza	19018	19022
PLYMOUTH			
01-75	All Other Models	*19018	*19022
89-71	Arrow, Champ, Colt, Laser		*19022
PLYMOUTH TRUCKS & VANS			
01-74	All Models	*19017	*19021
PONTIAC			
10-95	Trans Sport Montana	19018 & 19017	19022 & 19021
10-75	All Other Models	19018 & 19017	19022 & 19021
94-93	Trans Sport	*19017	*19021
94-82	Astre, J-2000, T-1000, LeMans, Sunbird		*19021
87-84	Fiero		19022 & 19021
PORSCHE			
12-70	All Models	19018 & 19017	19022 & 19021
RANGE ROVER			
12-01	All Models	19022 & 19021	
SAAB			
12-79	All Models		19022 & 19021
SATURN			
10-07	Outlook	19018 & 19017	19022 & 19021
10-90	All Other Models	*	*19021
SUBARU			
12-78	All Other Models		19022 & 19021
94-87	Justy, Samurai	*	*19021
SUZUKI SUV			
12-88	All Models	*	*19021
TOYOTA			
12-91	Avalon, Camry	19018 & 19017	19022 & 19021
12-80	Starlet, Tercel Sedan, Corolla Coupe, Sedan, Liftback	*19021	*19022
12-72	All Other Models	19018 & 19017	19022 & 19021
TOYOTA TRUCK			
12-81	Land Cruiser & Other Models	19022 & 19021	
12-70	4-Runner, Pickup, Van, Paseo		*19022
80-69	Land Cruiser		*19022
VOLKSWAGEN			
12-80	Jetta, Quantum, Fox, Golf, Passat		19022 & 19021
12-74	All Other Models	*	*19021
VOLVO			
12-70	All Other Models		19022 & 19021
97-84	240-740-760 Series		*19022

TRIMMING SUNDRIES & FASTENERS



2385

Door Trim Panel Fastener
Chrysler

UNIT PACKAGE: 100



2309

Door Trim Panel Fastener
All cars with .125 Panels
Ford

UNIT PACKAGE: 100



808

General Purpose
Head Diameter: 1/2"
Chrysler

UNIT PACKAGE: 100



8206

Door Trim Panel Fastener
Ford

UNIT PACKAGE: 100



2310

Door Trim Panel Fastener
Chrysler

UNIT PACKAGE: 100



11863

(383033-S101)
Phosphate

Door Trim Panel Fastener
Ford

UNIT PACKAGE: 50



23292

(383035-S100)

Door Trim Panel Retainer with Anti-Rattle Wedge
Ford 1975

UNIT PACKAGE: 100



807

General Purpose
Head Diameter: 1/2"
Chrysler

UNIT PACKAGE: 100



9361

(Ford: 358470; Chry: 1900654)

Door Trim Panel Fastener
Ford & Chrysler

UNIT PACKAGE: 100



2272

(358107)

Body Belt Moulding & Hood Side Moulding Fastener
Ford

UNIT PACKAGE: 100



1256

(353123)

Rear Quarter Strip (Inside), Instrument Panel Moulding & Hood Side Moulding Fastener

Ford & Chrysler

UNIT PACKAGE: 50



11406

Trim Clip Fastener
Head Diameter: 1/2"
Fits into 1/4" Hole

UNIT PACKAGE: 100



24169

(Not Available from OEM)

Weatherstrip Clip
Ford

UNIT PACKAGE: 50



23786

Door & Quarter Glass Outer Weather Strip Clip
GM, Ford & Chrysler
Some Imports

UNIT PACKAGE: 50



18402

Phosphate

Weatherstrip Clip
GM

UNIT PACKAGE: 25



23563
(4887979)
Black Phosphate
Weatherstrip Clip
GM Trucks 1963 - 1964
UNIT PACKAGE: 100



23617
(325338)
Black Phosphate
Door Weatherstrip Clip
GM 1971 - 1972
UNIT PACKAGE: 50



12134
(4114785)
Zinc
Trim Panel Fastener
Fits into 5/16" Hole
Chrysler
UNIT PACKAGE: 50

Bulk Quantities

The items listed below are available in bulk quantities of 25,000 or more. Quotation on Request

A = Head O.D.
B = Prong Length
C = Hole Size
D = Width of Diamond



1202
Sandstone
General Purpose
A: 17/32"
B: 1-17/64"
C: 9/32"
D: 7/16"
UNIT PACKAGE: 100

Footman Loops



Auveco Part No.	Size	Hole Size	Hole Ctr. to Hole Ctr.	Overall Length	Unit Pkg.
Steel-Nickel Plated					
7771	For 1" Strap	7/32"	2-1/8"	2-5/8"	25
7772	For 1-1/4" Strap	1/4"	2-1/4"	2-3/4"	25
7773	For 1-1/2" Strap	1/4"	2-5/8"	3-1/8"	25

Hog Rings

To attach seat covers to cushions and seat bottoms, as well as, cushion spring clips.



7595
Medium
.080" Wire Diameter
UNIT PACKAGE: 500



22450
Galvanized Steel
Inside Diameter: .740"
Outside Diameter: .870"
Wire Diameter: .073"
UNIT PACKAGE: 500



7644
Large
.088" Wire Diameter
UNIT PACKAGE: 500



12671
3/4" Nail (.750)
"Nail On" Door Panel Repair Clip
Slips on Door Panel Fastener Strip for repairs to replace broken Nails in Panel Edging
Replaces Auveco No. 7585 GM
UNIT PACKAGE: 50



12069
(416629)
Zinc
Upholstery Clips
GM 1979-On
UNIT PACKAGE: 50



9417
Snap-On Trim Clip
Panel Range: .105"-.115"
UNIT PACKAGE: 100



9416
Snap-On Trim Clip
Panel Range: .060"-.090"
UNIT PACKAGE: 100



7578
Seat Cushion Upholstery Clip
Can be used to repair drooping headliners in Honda
UNIT PACKAGE: 500

TRIMMING SUNDRIES & FASTENERS



7707

Cloth Lined Cushion Spring Clip
to fasten Springs to each other or to border Wire.
Length: 7/8"
For 1/4" or two 8 Gauge Wires

UNIT PACKAGE: 100



2850

Front Seat Self-Locking Clip
Ford

UNIT PACKAGE: 100



8665

Front Seat Rod End Nut
Outer Diameter: 15/16"
Stud Size 1/2"
Chrysler

UNIT PACKAGE: 100



8719

(4000155)
Zinc

Front Seat Inner Bracket Nut
Outer Diameter: 11/16"
Stud Size: 3/8"
Rambler

UNIT PACKAGE: 100



2672

Front Seat Hinge Arm Clip
GM

UNIT PACKAGE: 100



Grommets and Washers Solid Brass

7348	7/16" Hole	Size No. 3
7349	1/2" Hole	Size No. 4

NOTE: Grommets and Washers bagged separately.

UNIT PACKAGE: 144 Grommets & 144 Washers



Flanged Type Countersunk Washers

Screw Size	I.D.	O.D.	Nickel on Brass Part No.	Black Oxide on Brass Part No.	Stainless Steel Part No.	Unit Pkg.
#6	5/32"	1/2"	3469		3470	100
#8	13/64"	5/8"	2515	16009	2597	100
#10	1/4"	11/16"	3471		3472	100



Flush Type Washers Nickel Plated on Brass

Unit Pkg. 100	Unit Pkg. 144	Unit Pkg. 1000	Screw Size	I.D.	O.D.
	7137	7624	#6	5/32"	11/32"
604	7138		#8	3/16"	3/8"
16015		16016	#10	13/64"	15/32"



Countersunk Type Washers

Screw Size	I.D.	O.D.	Nickel Plated Brass			Black Ebonol Plated Brass	
			Unit Pkg. 100	Unit Pkg. 144	Unit Pkg. 1000	Part No.	Unit Pkg.
#4	9/64"	3/8"	612		7613		
#6	11/64"	7/16"	614	7143	7615	16011	100
#8	13/64"	1/2"		7145	7616	16012	100
#10	1/4"	19/32"	618	7147	7618	16013	100
#12	9/32"	11/16"	619	7148			

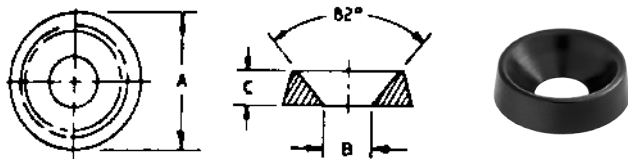

Nylon Finishing Washers

Available in natural or black nylon, these molded washers protect cabinets from scratching, cover misaligned holes, etc. May also be used as guides, bumpers and spacers.

Auveco Part No.	Screw Size	O.D. (A)	I.D. (B)	Thickness (C)	Color	Unit Pkg.
13717	#6	.437"(11.10mm)	.143"(3.63mm)	.100"(2.54mm)	Black	50
13718	#8	.515"(13.08mm)	.171"(4.34mm)	.115"(2.92mm)	Natural	50
13719	#8	.515"(13.08mm)	.171"(4.34mm)	.115"(2.92mm)	Black	50
13720	#10	.580"(14.73mm)	.191"(4.85mm)	.152"(3.86mm)	Natural	50
13721	#10	.580"(14.73mm)	.191"(4.85mm)	.152"(3.86mm)	Black	50
13723	#12	.609"(15.47mm)	.225"(5.72mm)	.160"(4.06mm)	Black	50
13724	#14	.683"(17.35mm)	.251"(6.38mm)	.183"(4.65mm)	Natural	50
13725	#14	.683"(17.35mm)	.251"(6.38mm)	.183"(4.65mm)	Black	50

Pop on Screw Covers & Bases

Covers: Matte Finish



Ultra Violet Stabilized Polypropylene covers and bases help shield screws from corrosive environments. Their smooth finish forms a protective barrier against rough-edges.

For use with flat head and oval head tapping screws and round head machine screws.

They're simple to use:

1. Place washer over pilot or starting hole for screw, nail or rivet.
2. Install fastener
3. Place Snap Cap over washer at slight angle.
4. Simply push Snap Cap down firmly.

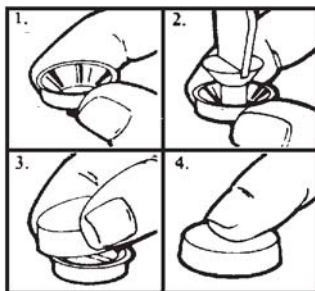

Screw Cover Bases

Auveco Part No.	Unit Pkg.	Screw Size
13840	50	#6
13841	50	#8
13842	50	#10

Screw Covers

Auveco Part No.	Unit Pkg.	Color
13831*	50	Black
13833*	50	Black
13835•	50	Black
13836•	50	White
13837•	50	Black
13838•	50	White

* 1/2" O.D.

• 5/8" O.D.



19413

(F7UZ-15238A32)
Black Nylon

Door Panel Screw Cover
Head Diameter: 3/4" (19mm)
Fits into 5/8" (16mm) Hole
Ford Econoline E150 1997-On

UNIT PACKAGE: 25

Accessories for use on Landau Tops



9877

Zinc

#4-24 x 3/8"
Head Diameter: 7/32"
Type AB

Used in place of Welded Studs on Landau Tops

UNIT PACKAGE: 100



9850

(7731589)
Natural Nylon

Landau Top Moulding Clip
Use with Auveco Screw 9877

UNIT PACKAGE: 100



10632

Nylon

Landau Top Moulding Clip
Use with Auveco Screw 9877

UNIT PACKAGE: 100

TRIMMING SUNDRIES & FASTENERS



9342
(4459049)
Nylon

Door Trim Pad Grommet
Screw Size: #8 or #10
Stem Length: 9/16"
Buick & Oldsmobile

UNIT PACKAGE: 50



18398
(20058837)
Nylon

Windshield Upper Garnish Clip
GM A & G Models
1988-78

UNIT PACKAGE: 10



3617
(6280765)
Nylon

Door Trim Pad Grommet
Screw Size: #4
Stem Length: 7/16"
Chevrolet & Oldsmobile

UNIT PACKAGE: 100

TOOLS & TRUCK SEAT SPRINGS

Truck Seat Springs

16213
(E0TB-1063-226AC,
E3TB-1063-226AA)

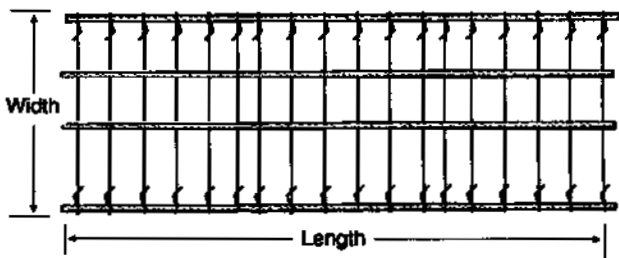

Photo not actual size

Length: 52"
Width: 16-3/4"
Number of Wires: 52
Ford Full Size Pick-Ups &
Light Truck 1980-On

UNIT PACKAGE: 5

Wire Bending Tool 16894



Photo not actual size

For truck seat springs

A tough tool that makes difficult wire repairs easy. You can bend the ends of no sags, edgewise and foam springs right on the spot, making offsets where you need them. Can be readily mounted in a vise for duplicating complex repetitive wire bends. Constructed of heat-hardened steel for long life.

UNIT PACKAGE: 1



16865
(20462090)
Nylon

Garnish Moulding Clip
Buick Century & Regal,
Chevrolet Camaro, Celebrity,
Monte Carlo & Malibu, Oldsmobile
Cutlass & Ciera, Pontiac Firebird
Grand Prix & 6000 1978-On

UNIT PACKAGE: 25



11119
(9617200)
Nylon

Headliner Clip
Inner Side Front, Center & Rear
GM 1973-On

UNIT PACKAGE: 100

CURTAIN & SNAP FASTENERS WITH ACCESSORIES



Button
Nickel on Brass
1 1/64" Barrel Length
14830 - Black Delrin Cap

UNIT PACKAGE: 50

7677 - Nickel Cap

UNIT PACKAGE: 100



Socket
Nickel on Brass
7678 - Normal Action

UNIT PACKAGE: 100



Stud
Nickel on Brass
7679 - Clinch Type

UNIT PACKAGE: 100



Eyelet
Nickel on Brass
7682 - 1/4" Barrel Length

UNIT PACKAGE: 100

Buttons 7677 and 14830 assemble with socket 7678.
Stud 7679 assembles with eyelet 7682.
The two assembled units then snap together.
An assembled button (7677, 14830) and socket (7678)
unit can be used with fasteners listed below.



Phillips Wood Screw
Nickel on Brass
9814 - #8 x 3/8"
7680 - #8 x 5/8"

UNIT PACKAGE: 100



Phillips Head
Stainless Steel Screw

14833 - #8 x 3/8"
14834 - #8 x 5/8"
15687 - #10 x 5/8"

UNIT PACKAGE: 50



Phillips Head
16418 - #8 x 1/2"
Nickel on Brass
16419 - #8 x 3/4"
Stainless Steel Screw

UNIT PACKAGE: 25



Wood Screw Stud
Nickel on Brass
7688 - #7 x 1/2"

UNIT PACKAGE: 100



7419
Single curtain
Use with #4 stainless steel,
chrome or brass screws
(screws sold separately)

UNIT PACKAGE: 100



7409
Eyelets & washers
Use with Auveco Fasteners
7417 and 7419

UNIT PACKAGE: 100 Sets

TRIMMING SUNDRIES & FASTENERS

Refer to Retainer Specification Chart on pages 510-523



18684
(10262036)
Black Nylon

Control Panel Trim Retainer
Chevrolet Lumina & Monte Carlo 1995-On

UNIT PACKAGE: 100



21627
(67868-30030)
Black Nylon

Door & Roof Rail Retainer
Lexus 2006 - On
Toyota 1974 - On

UNIT PACKAGE: 25



21458
(91567-S3M-000)
Black Nylon

Weatherstrip Retainer
Honda Accord,
Civic & Odyssey 2003 - On

UNIT PACKAGE: 25



22586
(Honda: 90651-TG7-000)
Black Nylon

Door Seal Retainer
Head Diameter: 10.6mm
Stem Diameter: 5.5mm
Stem Length: 8mm
Honda Pilot & Ridgeline 2017 - On

UNIT PACKAGE: 50



19686
(90467-05045-22)
Black Nylon

Weatherstrip Retainer
Toyota Solara 1998 - On

UNIT PACKAGE: 25



21548
(67869-20030)
Black Nylon

Weatherstrip Retainer
Lexus IS 300 & SC 430 and Toyota Camry, Celica,
Corolla, Highlander, Matrix, MR-2, Prius, RAV-4,
Scion, Solara & Supra 1990 - On

UNIT PACKAGE: 25



14367
(9924-90-512B)
Black Nylon

Retainer
Mazda

UNIT PACKAGE: 50



18683
(10063599)
Black Nylon

**Remote Control Door
Lock Receiver Retainer**
Chevrolet Lumina & Monte Carlo,
Oldsmobile Cutlass and Pontiac Bonneville
& Grand Prix 1991 - On

UNIT PACKAGE: 100



14921
(GM: 20699808; Chry: 6502328)
Black Nylon

Door Weatherstrip Retainer
GM 1974 - On
Dodge Ram 1994 - On

UNIT PACKAGE: 50



20165
(4658887)
Black Nylon

Trim Panel Retainer
Chrysler LH & LHS Series 1997 - On

UNIT PACKAGE: 50



20528
(24205245)
Black Nylon

Rear Bumper Cover Retainer
Chevrolet Cavalier & Pontiac Sunfire
1995 - On

UNIT PACKAGE: 50



11129
(2964547)
Black Nylon

Weatherstrip Retainer
Chrysler 1977 - On

UNIT PACKAGE: 25



22794
(BMW: 52-20-8-133-466)
Black Nylon

Motion Sensor Retainer
Head Diameter: 18mm
Stem Diameter: 5.7mm
Stem Length: 12mm
BMW 1, 2, 3, 4, 5, 6, 7, 8, i3,
i8 X & Z Series 1992 - On

UNIT PACKAGE: 30

TRIMMING SUNDRIES & FASTENERS

Refer to Retainer Specification Chart on pages 510-523

Sec. 19



20344
(10169777)
Black Nylon

Weatherstrip Retainer
Chevrolet Impala, Lumina & Monte Carlo
and Pontiac Aztek 1995 - On

UNIT PACKAGE: 25



18389
(25603960)
Black Nylon

Radiator Baffle Retainer
Olds 98 Regency 1994 - On

UNIT PACKAGE: 25



22927
(Ford: W718046-S300)
Black Nylon

Bumper & Mud Guard Retainer
Head Diameter: 12.5mm
Stem Diameter: 7mm
Stem Length: 9mm
Ford Edge 2018 - 2015
Ranger 2019 - On

UNIT PACKAGE: 25



14021
(N803170-S)
Black Nylon

Fascia Retainer
Ford Mustang & Capri 1984 - On

UNIT PACKAGE: 25



21936
(Peugeot & Citroen: 6992.07)
Black Nylon

Trim Panel Retainer
Peugeot & Citroen

UNIT PACKAGE: 25



11120
(8731909)
Black Nylon

Door Weatherstrip Retainer
GM 1963 - On

UNIT PACKAGE: 100



18302
(GM: 20538173; Chry: 6104908-AA;
Mercedes: 002-997-33-86-67;
Honda: 91531-THR-A01)
Black Nylon

Weatherstrip Retainer
Buick Century & Riviera, Chevrolet Lumina, Olds Aurora
& Regency and Pontiac Grand Prix 1989 - On;
Chrysler 2008 - On; Mercedes-Benz;
Acura TLX 2021 - On, Honda Odyssey 2018 - On

UNIT PACKAGE: 50



14006
(20455900)
Black Nylon

Moulding Retainer
GM 1984 - On

UNIT PACKAGE: 25



25075
(Lexus & Toyota: 90467-05162-C0)
Black Nylon

Belt Moulding Retainer
Head Diameter: 12mm
Stem Size: 5mm x 5.8mm
Stem Length: 10mm
Overall Height: 12mm
Fits into 5mm Hole
Lexus ES 350 2012 - 2007; GS 200t 2019 - 2016;
GS 350 2013 - On; GX 460 2010 - On;
IS 200t 2016 - On; IS 250 2015 - 2012;
IS 350 2012 - On; LC 500 2018 - On;
LS 460 2017 - 2007; LS 600 2013 - 2008;
RC 200t 2015 - On; RC 300, RC 350 2015 - On;
RX 330 2006 - 2004; RX 350 2009 - 2007;
RX 400h 2008 - 2006; Toyota 4Runner 2010 - On;
Landcruiser 2008 - On; Matrix 2014 - 2010;
Sienna 2011 - On; Venza 2017 - 2009

UNIT PACKAGE: 25



21519
(01553-01A50)
Black Nylon

Bumper & Trim Retainer
Infiniti FX35, G35, G37, M35, M45 & Q45 and
Nissan 350Z & 370Z 1997 - On

UNIT PACKAGE: 25



17634
(01553-01781)
Black Nylon

Cowl Grille Retainer
Nissan 240SX 1990 - On

UNIT PACKAGE: 25



20893
(GM: 10293193;
Ford: N811040-S)
Black Nylon

**Hood Insulation &
Door Weatherstrip Retainer**
Chevrolet Cobalt & Ford Mustang 2005 - On

UNIT PACKAGE: 50



18298
(22536642)
Black Nylon

Rear Bumper Fascia Retainer
Chevy Cavalier, Olds Calais, Pontiac
Grand Prix, Sunbird & 6000 1988 - On

UNIT PACKAGE: 50

TRIMMING SUNDRIES & FASTENERS

Refer to Retainer Specification Chart on pages 510-523



19673
(72311-S10-003)
Black Nylon

Weatherstrip Retainer
Honda CRV 1997 - On

UNIT PACKAGE: 15



20311
(N803857S)
Black Nylon

Front End Fascia Retainer
Replaces Auveco 15483
Ford Aerostar, LTD & Marquis 1985 - On

UNIT PACKAGE: 50



23802
(14943-05210 DL)
Regatta Blue Nylon

Interior Trim Retainer
Head Diameter: 13mm
Stem Diameter: 6.8mm
Stem Length: 21mm

UNIT PACKAGE: 100



11721
(411700)
Black Nylon

Trim Panel Retainer
GM 1968-On

UNIT PACKAGE: 50



19149
(4658673)
Black Nylon

Weatherstrip Retainer
Front & Rear Doors
Chrysler Neon 1996-On

UNIT PACKAGE: 50



18948
(GM: 1644290; Nissan: 01553-0075U)
Black Nylon

**Hood Insulation, Rear Bumper Fascia
& Door Trim Plate Retainer**
GM 1991 - On; Nissan: 2002 - On

UNIT PACKAGE: 25



18897
(10078274)
Black Nylon

**Side Roof Rail
Weatherstrip Retainer**
Chevrolet Corsica & Beretta 1989 - 87

UNIT PACKAGE: 25



11680
(25016383)
Black Nylon

Dash Panel Retainer
GM 1977 - On

UNIT PACKAGE: 50



11612
(GM: 20413107; Ford: 388246S
AMC: 4006516)
Black Nylon

Weatherstrip Retainer
GM, Ford & AMC

UNIT PACKAGE: 50



14289
(90666-SA0-003)
Black Nylon

Retainer
Honda

UNIT PACKAGE: 25



22718
(VW: 6Q0-867-333)
Black Nylon

Inner Door & Quarter Trim Retainer

Head Diameter: 15mm
Stem Diameter: 5.7mm
Stem Length: 19mm
Audi A3, A7, RS 7, S3, S7 & TT 2012 - On
Volkswagen GTI, Golf, Golf Alltrack,
Golf R, Golf SportWagen
& e-Golf 2015 - On

UNIT PACKAGE: 25



19836
(6505417AA)
Black Nylon

Trim Panel Retainer
Chrysler

UNIT PACKAGE: 50



23608
(2898909 & 382570 S)
Nylon

Dash & Cowl Panel Retainer

Head Diameter: 12.4mm
Stem Diameter: 7mm
Stem Length: 13.0mm
GM, Chrysler & Ford 1970

UNIT PACKAGE: 100



22900
(Mercedes: 000-991-28-95)
Black Nylon

Sun Visor Hinge Cover Retainer

Head Diameter: 14mm
Stem Diameter: 8mm
Stem Length: 12mm
Mercedes-Benz B 250e 2017 - 2016
C 300, AMG* C 43, AMG* C 63, E 400, E 450,
AMG* E 53, GLC 300, GLC 350e, AMG* GLC 43
& AMG* GLC 63 2018 - On

UNIT PACKAGE: 50

TRIMMING SUNDRIES & FASTENERS

Refer to Retainer Specification Chart on pages 510-523

Sec. 19



14017

(390126-S)
Black Nylon

Fascia Retainer
Ford Mustang &
Capri 1984 - On

UNIT PACKAGE: 25

14857

Same as 14017 except for unit package quantity

UNIT PACKAGE: 50



18682

(10098645)
Black Nylon

Front Door Lower Moulding Retainer
Pontiac Grand Prix with
Sport Performance Package 1994 - On

UNIT PACKAGE: 50



20256

(01553-01182)
Black Nylon

Splash Shield Retainer
Nissan Frontier Truck 1997 - On

UNIT PACKAGE: 50



17453

(B003-68-865-96)
Gray Nylon

**Rear Compartment
Interior Trim Retainer**
Ford Probe 1988 - On
Mazda MX6 1988 - On

UNIT PACKAGE: 50



21755

(Mazda: B003-68-865-00)
Black Nylon

Trim Panel Retainer
MPV 1998 - 89

UNIT PACKAGE: 50



23933

(6034608, N806667-S)
Nylon

Headliner Front Fender Retainer
Head Diameter: 18mm
Stem Diameter: 7mm
Stem Length: 16mm
Jeep Grand Cherokee 1991 - On
Ford

UNIT PACKAGE: 25



19312

(90467-05096-22)
Black Nylon

**Luggage Compartment
Trim Panel Retainer**
Toyota Tercel & Paseo 1994 - On

UNIT PACKAGE: 25



21693

(Lexus: 90467-05125)
Black Nylon

Front Bumper Bracket Retainer
Lexus GS 300, GS 450h
& LS 400 1995 - On

UNIT PACKAGE: 25



21303

(90671-S0D-003ZK)
Black Nylon

**Trunk Lid &
Interior Trim Retainer**
Honda Accord 2010 - On

UNIT PACKAGE: 25



21589

(99045AE03AMA)
Black Nylon

Trim Panel Retainer
Subaru B9 Tribeca, Impreza,
Legacy & Outback 2005 - On

UNIT PACKAGE: 25



23962

(30000784,09409-05309-5ES)
Black Nylon

Cowl Vent Retainer
Head Diameter: 14mm
Stem Diameter: 6mm
Stem Length: 15mm
Geo Tracker 1999 - On;
Suzuki Vitara 1999- On

UNIT PACKAGE: 25



18815

(6502381)
Black Nylon

**Radiator Grille
Sight Shield Retainer**
Dodge Caravan &
Plymouth Voyager 1993 - On

UNIT PACKAGE: 50



19506

(90666-SA7-003ZW)
Black Nylon

Trunk Lining Retainer
Acura 2.5TL, 3.2TL, 3.5, Integra &
Legend, Honda Accord Wagon
& Prelude 1987 - On

UNIT PACKAGE: 15

TRIMMING SUNDRIES & FASTENERS

Refer to Retainer Specification Chart on pages 510-523



21349
(85746-06000LX)
Gray Nylon

Headliner Retainer
Kia Rio 2010 - On

UNIT PACKAGE: 25



21350
(85746-06000RU)
Tan Nylon

Headliner Retainer
Kia Rio 2010 - On

UNIT PACKAGE: 25



15050
Black Nylon

Shroud Retainer
High Retention Capability
GM, Ford & Chrysler

UNIT PACKAGE: 50



15367
(20514862)
Black Nylon

**Screen Shroud Vent
Grille to Panel Retainer**
GM 1985 - On

UNIT PACKAGE: 50



11675
(GM: 25514221;
Chry: 6003587)
Black Nylon

Roof Headliner Retainer
GM & Chrysler 1982 - On

UNIT PACKAGE: 50



21199
(Ford: W711687-S300;
GM: 11589181)
Black Nylon

Bumper and Fender Apron Retainer
Ford Focus and GM Full-Size
Pick-Up Trucks 2007 - On

UNIT PACKAGE: 25



14709
(Mazda: G030-68-885-B-38;
Ford: F22Z-16774-A, GA2A-56694)
Nylon

Hood Insulation Retainer
Mazda & Ford Probe

UNIT PACKAGE: 25



21661
(TD11-56-694)
Black Nylon

Hood Insulation Retainer
Mazda 3, 5, 6, CX7, CX9, MX5 Miata & RX8 2004 - On

UNIT PACKAGE: 25



20399
(W701374-S)
Black Nylon

Hood Insulation Retainer
Ford Escape 2001 - On

UNIT PACKAGE: 25



11679
(GM: 20032850; Ford: 387258-S;
Chry: 3861577)
Black Nylon

Mud Shield Retainer
GM, Ford & Chrysler 1976 - On

UNIT PACKAGE: 100



13454
(20511451)
Black Nylon

Cowl Vent Retainer
GM 1984 - On

UNIT PACKAGE: 25



11347
(3861577)
Black Nylon

Front Seat Adjuster Cover Retainer
Chrysler 1975 - On

UNIT PACKAGE: 25



19643
(90467-06175)
Black Nylon

Luggage Compartment Retainer
Toyota Solara 1998 - On

UNIT PACKAGE: 15



20184
(90467-08186, 90467-08186-C3)
Black Nylon

**Luggage Compartment, Wheelhouse Liner
Trim Retainer**
Lexus LS500 2021, Toyota Camry 1999 - On,
Corolla 2022 - 2021, Mirai 2022 - 2017,
Sequoia 2022 - 2020, Tacoma 2022 - 2018

UNIT PACKAGE: 25



22598
(Lexus: 90467-07208)
Black Nylon

Fender Seal Retainer
Head Diameter: 16mm
Stem Diameter: 8mm
Stem Length: 16mm
Fits into 8mm Hole
Lexus ES 300h, ES 350, IS F,
LS 460 & LS 600h 2013 - On

UNIT PACKAGE: 25

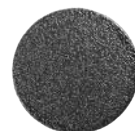

TRIMMING SUNDRIES & FASTENERS

Refer to Retainer Specification Chart on pages 510-523

Sec. 19



22705

(Subaru: 909130162)
Dark Gray Nylon

Interior Foot Rest Pad Retainer
Head Diameter: 16mm
Stem Diameter: 7.7mm x 7.7mm
Stem Length: 30mm
Fits into 8mm Hole
Subaru BRZ, Crosstrek, Forester,
Impreza, Legacy, Outback,
Tribeca & WRX 2006 - On

UNIT PACKAGE: 25



19667

(N801994-S100)
Black Nylon

Trim Panel Retainer
Ford 1982 - On

UNIT PACKAGE: 25



22555

(0K95B68865 ; 0B10268865)
Black Nylon

Trunk Trim Retainer
Head Diameter: 20mm
Stem Length: 13mm
Stem Diameter: 7mm

UNIT PACKAGE: 25



21253

(90467-05164-B6)
Gray Nylon

Headliner Retainer
Toyota Yaris 2009 - On

UNIT PACKAGE: 25



21332

(90467-05164-E2)
Tan Nylon

Headliner Retainer
Toyota Corolla & Yaris 2009 - On

UNIT PACKAGE: 25



21560

(G032-68-865A-00)
Black Nylon

Trunk & Carpet Retainer
Mazda B2000, B2600, CX-7, CX-9, Miata,
Millenia, MX-3, MX-5, MX-6, Protege, RX-7,
RX-8, 3, 5, 6, 626 & 929 1987 - On

UNIT PACKAGE: 25



21673

(W715926-S300)
Black Nylon

**Fender, Bumper, Trunk
& Interior Trim Retainer**
Ford Escape & Focus 2012 - On

UNIT PACKAGE: 25



21630

(95022AC040ML)
Black Nylon

**Headliner & Trim
Space Retainer**
Subaru Forester, Impreza,
Legacy & Outback 1998 - On

UNIT PACKAGE: 25



14757

(N804448)
Black Nylon

Engine Mount Heat Shield Retainer
Ford Taurus & Sable 1986 - On

UNIT PACKAGE: 25



19470

(90108-SW3-003)
Black Nylon

Bumper Retainer
Use with Auveco 19650
Honda Accord,
Odyssey & Prelude 1995 - On

UNIT PACKAGE: 15



19744

(90669-SP0-003ZA)
Black Nylon

Trunk Trim Retainer
Honda Civic 1998 - On

UNIT PACKAGE: 10



19893

(6501948)
Black Nylon

Fender & Bumper Shield Retainer
Chrysler 1995 - 89

UNIT PACKAGE: 50



20334

(90667-SOD-003ZC)
Black Nylon

Trunk Garnish Retainer
Honda Civic 1998 - On

UNIT PACKAGE: 15



22075

(Nissan: 01553-06451)
Black Nylon

**Upper Quarter Trim &
Rear Trunk Seal Retainer**
Infiniti G35, J30, JX60, M35, M37, M56, Q45,
Q50 & QX60 and Nissan Altima, Pathfinder
& Quest 1996 - On

UNIT PACKAGE: 25



16776

(Honda: 90667-SAO-0030;
Nissan: 76996-01P02)
Black Nylon

Trim Panel Retainer
Honda & Nissan

UNIT PACKAGE: 25

TRIMMING SUNDRIES & FASTENERS

Refer to Retainer Specification Chart on pages 510-523



19842
(75867-30110)
Black Nylon
Rocker Panel Clip
Toyota Corolla 1997 - On
UNIT PACKAGE: 15



18379
(W701380SSW)
Black Nylon
**Trunk Liner, Rear Seat Carpet,
& Radiator Side Shield Retainer**
Ford Contour &
Mercury Mystique 1995 - On
UNIT PACKAGE: 25



18174
(25601491)
Black Nylon
**Radiator Air Side Baffle
& Door Trim Panel Retainer**
Buick LeSabre &
Olds Delta 88 Royale 1992 - On
UNIT PACKAGE: 50



20531
(W708035-S300)
Black Nylon
Rear Bumper Cover Retainer
Use with Auveco 20532
Ford Expedition 2003 - On
UNIT PACKAGE: 25



21679
(Chrysler: 6509590-AA)
Black Nylon
Bumper Retainer
Chrysler 300 & Charger 2011 - On
UNIT PACKAGE: 25



16818
(GM: 21094146, 21110201; Chry: 6501301)
Black Nylon
Trim Panel Retainer
GM Saturn 1991 - On
Sliding Door & Lift Gate
Trim Panel Retainer
Chrysler Mini Vans 1987 - On
UNIT PACKAGE: 25



15040
(Chry: 5208743; AMC: 4006529)
Black Nylon
Trim Panel Retainer
Chrysler 1988 - 84
AMC 1988 - 84
UNIT PACKAGE: 50



24181
(1699250)
Nylon
Trim Panel Retainer
Head Diameter: 19mm
Stem Diameter: 7.6mm
Stem Length: 32mm
GM 1977 - On
UNIT PACKAGE: 50



19774
Black Nylon
Bumper Cover Retainer
Replaces Auveco 18106
Postal Vehicles &
General Purpose
UNIT PACKAGE: 25



20624
(Ford: W709002-SAA)
Black Nylon
Fender Flare Retainer
Ford Expedition &
Navigator 2003 - On
UNIT PACKAGE: 25



18301
(GM: 10185925; Chry: 6503768)
Black Nylon
Bumper Fascia Retainer
Chevy Lumina APV, Olds Silhouette
& Pontiac Trans Sport 1993 - On
UNIT PACKAGE: 25



20177
(Ford: W705955-S300; GM: 10146315)
Charcoal Gray
Nylon
**Wheel Opening Moulding, Cowl, Fender
Flare, Front Bumper Retainer**
GM: Buick LeSabre 1999 - 1995, Park Ave.
1996 - 1995, Terraza 2007 - 2005;
Cadillac Escalade 2014 - 2002;
Chevrolet Avalanche, Silverado 1500,
Suburban 2500 2018 - 2002, Lumina 1996 - 1994 &
1992 - 1990, Silverado 2500HD, 3500HD, Suburban 1500,
Tahoe 2014 - 2007, Uplander 2009 - 2005; GMC Sierra
1500, Sierra 2500HD, 3500HD, Yukon 2018 - 1999;
Oldsmobile 88 1999 - 1995, 88 1996 - 1995,
Silhouette 1992 - 1990; Pontiac Bonneville 1999 - 1995,
Montana 2009 - 2008, Transport 1992 - 1990;
Saturn Relay 2007 - 2005; Ford Explorer 2001 - 1997
UNIT PACKAGE: 50

TRIMMING SUNDRIES & FASTENERS

Refer to Retainer Specification Chart on pages 510-523



24580

(GM 10182300; Chrysler 6033018;
Ford N803678-S)
Black Nylon

**Front Bumper, Fender,
Trim Panels, Seat, & Carpet Retainer Head**
Diameter: 18.5mm
Stem Diameter: 7.5mm
Stem Length: 11mm
GM, Chrysler, Ford

UNIT PACKAGE: 50



20761

(W710312-S300)
Black Nylon

Cowl Vent Retainer
Ford Trucks
2004 - On

UNIT PACKAGE: 25



20366

(W701855-S300)
Black Nylon

**Fender Liner &
Mud Flap Retainer**
Ford Explorer &
Mountaineer 2002 - On

UNIT PACKAGE: 25



14032

(15588078)
Black Nylon

Pillar Cover Retainer
GM Truck 1985 - On

UNIT PACKAGE: 10



22180

(Ford: W714076-SS3JA)
Black Nylon

**Cowl, Interior Trim &
Splash Shield Retainer**
Ford F150 & Mustang 2015 - On

UNIT PACKAGE: 25



14036

(14074081)
Black Nylon

Rear Hood Seal Retainer
GM 1983 - On

UNIT PACKAGE: 25



18371

(15986343)
Gray Nylon

**Door Trim
Panel Retainer**
Chevrolet Astro & GMC Safari
Mini Vans 1994 - On
UNIT PACKAGE: 25



20192

(Ford: W707889-S300)
Black Nylon

Mud Flap Retainer
Ford Expedition &
F-150 1997 - On

UNIT PACKAGE: 25



20926

(W710532-S300)
Black Nylon

Rocker Moulding Retainer
Ford Mustang
2005 - On

UNIT PACKAGE: 25



25219

(Chrysler: 4857182AA)
Natural Nylon

Bumper Foam Absorber Retainer
Head Diameter: 25mm
Stem Diameter: 7.5mm
Stem Length: 44.5mm
Overall Height: 47mm
Chrysler Town &
Country 2016 - 2001,
Voyager 2003 - 2001; Dodge
Caravan 2007 - 2001,
Grand Caravan 2020 - 2001; Jeep
Grand Cherokee 2013 - On; Ram
C/V 2015 - 2012
UNIT PACKAGE: 25



14035

(22527720)
Natural Nylon

Hood Seal Retainer
GM 1981-On

UNIT PACKAGE: 25

TRIMMING SUNDRIES & FASTENERS

Refer to Retainer Specification Chart on pages 510-523



19855
(4717224)
Black Nylon

Trim Panel Retainer
Chrysler Concorde, Intrepid, LHS,
New Yorker, Vans & Vision 1993 - On
UNIT PACKAGE: 50



23907
(20227160)
Black Nylon

Interior Trim Retainer
Head Diameter: 23/32"
Stem Diameter: 19/64"
Stem Length: 9/16"
GM 1980 - On; Asian Cars

UNIT PACKAGE: 50



10831
(GM: 332364, 14093311, 20732399;
Ford: 389358, W701259-S300;
Chry: 3691590, 6031321, 6505411-AA,
AMC: 4004569)
Black Nylon

Fender & Bumper Shield Retainer
GM, Ford, Chrysler & AMC; Express &
Savana Vans 2010 - On, Transit Connect 2019 - On,
Transit 150, 250, 350 2015 - On

UNIT PACKAGE: 50

16259

Same as 10831 except for **unit package** quantity

UNIT PACKAGE: 100



10832
(GM: 6270163;
Chry: 6030538)
Gray Nylon

Fender & Bumper Shield Retainer
GM 1973 - On
Chrysler

UNIT PACKAGE: 50



15664
White Nylon
Fender & Bumper Shield Retainer
White version of Auveco 10831
GM, Ford, Chrysler & AMC

UNIT PACKAGE: 100



23937
Black Nylon

Cowl Vent Retainer
Head Diameter: 17.4mm
Stem Diameter: 7.6mm
Stem Length: 20mm
Ford 1992 - On

UNIT PACKAGE: 50



11146
(GM: 11569768, 15958694, 1605396;
Chry: 6030441;
Ford: 388577S, W705589-S300)
Black Nylon

**Radiator Yoke, Fender &
Bumper Shield Retainer**
GM, Ford & Chrysler

UNIT PACKAGE: 25

15414

Same as 11146 except for **unit package** quantity

UNIT PACKAGE: 100



19790
(Not Available from O.E.M.)
Gray Nylon

Trim Panel Retainer
Gray version of Auveco 11146
GM, Ford & Chrysler

UNIT PACKAGE: 50



19250
(Not Supplied by O.E.M.)
White Nylon

Trim Panel Retainer
White version of Auveco 11146

UNIT PACKAGE: 25



21756
(Not Available from O.E.M.)
Clear Nylon

Trim Panel Retainer
Clear version of Auveco 11146
Universal

UNIT PACKAGE: 50



17664
(GM: 10121502; Chry: 6033082,
6033840; Ford: 390018-S)
Black Nylon

Shield Retainer
Battery Post Cable Shield,
Engine Splash Shield
Radiator Side Air Baffle
GM 1989-On
Express & Savana Vans 1996 - On

UNIT PACKAGE: 50

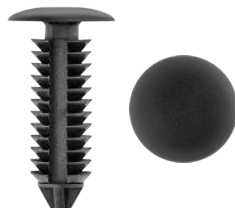

22521
(BMW: 52-20-1-964-201)
Black Nylon

Seat Back Panel Clip
Head Diameter: 14mm
Stem Diameter: 8mm
Stem Length: 25mm
BMW 3, 5, 7 Series, X5
& Z4 2016 - 1989

UNIT PACKAGE: 25

TRIMMING SUNDRIES & FASTENERS

Refer to Retainer Specification Chart on pages 510-523

Sec. 19



17612

(Chry: 6504043; Ford: N807721-S)
Black Nylon

Trim Panel Retainer
Ford Explorer 1993 - On
Trunk Lid Latch
Chrysler 1996 - On

UNIT PACKAGE: 50



23884

(10182300)
Black Nylon

Front Bumper Retainer
Head Diameter: 3/4"
Stem Diameter: 9/32"
Stem Length: 7/16"
GM Grand Prix 1991 - On

UNIT PACKAGE: 50



19373

(N807154-S)
Zuca Granite (Light Gray) Nylon

Trim Panel Retainer
Bottom Head Diameter : 19/32"
Top Head Diameter: None
Stem Diameter : 9/32"
Stem Length: 27/32"

UNIT PACKAGE: 50



22924

(Ford: W717082-S300)
Black Nylon

Headlight & Instrument Panel Retainer
Head Diameter: 19mm
Stem Diameter: 7.6mm
Stem Length: 22mm
Ford F-150 2018 - On
Fusion & Lincoln MKZ 2018 - 2013

UNIT PACKAGE: 50



20878

(90467-A0008)
Black Nylon

Bumper Cover Retainer
Toyota, Lexus & Scion 1995 - On

UNIT PACKAGE: 50



16775

(Honda: 90667-SA7-0030;
Nissan: 89427-98070)
Black Nylon

Trim Panel Retainer
Honda & Nissan

UNIT PACKAGE: 25



22449

(VW: N90-911-301)
Black Nylon

Interior Trim Panel & Cowl Cover Retainer
Head Diameter: 20mm
Stem Diameter: 8mm
Stem Length: 16mm
Audi A3 & S3 2015 - On
Volkswagen Golf, Jetta & Passat 2012 - On

UNIT PACKAGE: 25



19121

(90467-08104)
Gray Nylon

Roof Headliner Retainer
Toyota MR2 1990 - On
UNIT PACKAGE: 15



22503

(Nissan: 01553-0170U)
Black Nylon

Front Bumper Cover Retainer
Head Diameter: 18mm
Stem Diameter: 8.5mm
Stem Length: 19mm
Nissan Altima 2015 - On
UNIT PACKAGE: 25



21026

(4860379-AA)
Black Nylon

Door Trim Panel Retainer
Dodge 300 Series, Magnum
& Charger 2005 - On
UNIT PACKAGE: 25



16132

Black Nylon

Trim Panel Retainer
Universal

UNIT PACKAGE: 25



15543

(GM: 22547243, 11610086,
Chry: 6501916)
Black Nylon

Splash Shield & Wheel Well Cover Retainer
Chrysler 1988 - On
Hood Seal Retainer
GM 1989 - On
UNIT PACKAGE: 50



21392

(1H0-819-055-B01C)
Black Nylon

Instrumental Panel, Cowl Vent, Defroster Grille & Ducts Retainer
Phillips Drive
Audi and Volkswagen Cabrio,
Golf & Jetta 2002 - 1993
UNIT PACKAGE: 25

TRIMMING SUNDRIES & FASTENERS

Refer to Retainer Specification Chart on pages 510-523



21257

(Chry: 6508727-AA;
Ford: W706815-S300)
Black Nylon

Trunk Trim and Insulator Retainer
Ford Focus, Fusion, Milan,
MKZ & Zephyr 2006 - On

UNIT PACKAGE: 25



17076

(GM: 94145515;
Isuzu: 8941455150)
Black Nylon

**Inner Fender Shield &
Bumper Fascia Retainer**
Geo Storm & Isuzu 1990 - On

UNIT PACKAGE: 25



19834

(15975244)
Black Nylon

**Wiring Harness &
Headliner Retainer**
Engine Wiring Harness,
Tailgate, Headliner & Air Cleaner
GM C, E, K, S & T Trucks 1994 - On

UNIT PACKAGE: 50



19837

(Not Available from O.E.M.)
Black Nylon

Trim Panel Retainer
Chrysler

UNIT PACKAGE: 50



19127

(N808370-S)
Black Nylon

Carpet Retainer
Ford Taurus & Sable 1996 - On

UNIT PACKAGE: 25



20189

(GM: 16674629;
Ford: N806113-S; Chry: 6503943)
Black Nylon

Trim Panel Retainer
Cadillac Concours, DeVille & Seville;
Chevrolet Impala, Lumina & Monte Carlo;
Dodge Ram & Dakota; Ford and Pontiac
Grand Prix 1995 - On

UNIT PACKAGE: 50



21905

(Renault & Dacia: 82-00-721-200)
Gray Nylon

Trim Panel Retainer
Renault & Dacia

UNIT PACKAGE: 25



20319

(W700671-S300)
Black Nylon

Hood Insulation Retainer
Ford Contour & Mystique 1995 - On

UNIT PACKAGE: 25



23859

(90058568)
Black Nylon

Insulation Panel Retainer
Head Diameter: 20mm
Stem Diameter: 8.3mm
Stem Length: 20mm
General Purpose

UNIT PACKAGE: 25



20360

(GM: 22189414;
Chry: 6505667-AA;
Ford: W705681-S300)
Black Nylon

**Engine Compartment &
Front End Retainer**

Buick LeSabre, Park Ave.,
Rendezvous, & Riviera;
Cadillac DeVille & Seville;
Chevrolet Venture, Oldsmobile
Silhouette and Pontiac Aztek,
Bonneville & Montana 2000 - On; Chrysler 2010 - On;
Ford Ranger 2019 - On; Bronco 2021 - On; Escape
2019 - 2013; Transit 2019 - 2015; Focus 2011 - 2005;
Lincoln Continental 2019 - 2017; MKX 2019 - 2015

UNIT PACKAGE: 25



22576

(GM: 13475541)

Headliner Retainer
Head Diameter: 25mm
Stem Diameter: 7.3mm
Stem Length: 21mm
Fits into 6.5mm Hole
Buick Regal Sportback
and Chevrolet Cruze,
Equinox & Volt 2016 - On

UNIT PACKAGE: 25

TRIMMING SUNDRIES & FASTENERS

Refer to Retainer Specification Chart on pages 510-523

Sec. 19



21248
(15944588)
Tan Nylon

Headliner Retainer
Chevrolet Malibu 2004 - On

UNIT PACKAGE: 25



19760
(N807535-S)
Black Nylon

Kick Plate Retainer
Ford Ranger 1993 - On

UNIT PACKAGE: 50



21301
(11610747)
Black Nylon

Grille Retainer
Use with Auveco 21302
Cadillac SRS & SRX and Chevrolet Camaro
2010 - On

UNIT PACKAGE: 25



23782
(N90282401, 3096724)

Fender Door Trim Panel Clip
Head Diameter: 19mm
Stem Diameter: 7.3 x 8.3mm
Stem Length: 18mm
Volkswagen Rabbit, GM S10 2004 - On

UNIT PACKAGE: 50



21338
(15802005)
Black Nylon

Fender & Headliner Retainer
GM Acadia, Camaro, Enclave, Traverse,
& Saturn Outlook 2008 - On

UNIT PACKAGE: 25



15523
(E9SB-6302354-ACW)
Black Nylon

Cowl Side Trim Retainer
Ford T-Bird & Cougar
1989 - On

UNIT PACKAGE: 25



19541
(6504135)
Black Nylon

Hood Insulation Retainer
Chrysler Mini-Vans & Durango 1997 - On

UNIT PACKAGE: 50



22589
(Mitsubishi: MU001282)
Black Nylon

Hood Insulation Retainer
Head Diameter: 26mm
Stem Diameter: 10mm
Stem Length: 10mm
Fits into 9mm Hole
Mitsubishi Diamante, Eclipse,
Endeavor, Galant, Lancer, Mirage,
Montero & Outlander 1992 - On

UNIT PACKAGE: 50



10332
(2998430)
Black Nylon

Radiator Grille Retainer
Chrysler

UNIT PACKAGE: 25



21090
(24501057)
Black Nylon

**Fender Apron &
Radiator Baffle Retainer**
Cadillac Escalade,
Chevrolet Denali & Tahoe,
GMC Yukon and
Hummer H3 2006 - On

UNIT PACKAGE: 25



15481
(6501067)
Black Nylon

Fascia Retainer
Chrysler 1985-On

UNIT PACKAGE: 50



15480
(Ford: N802734S; GM: 22718305)
Black Nylon

**Trim Panel & Hood
Insulation Retainer**
Ford 1983 - On
GM 1997 - On

UNIT PACKAGE: 50

TRIMMING SUNDRIES & FASTENERS

Refer to Retainer Specification Chart on pages 510-523



19197
(N802734-S)
Medium Opal (Gray) Nylon

UNIT PACKAGE: 50



12731
(20319841)
Black Nylon
Seat Back Retainer
GM Camaro & Firebird 1982 - On

UNIT PACKAGE: 25



20281
(11518201)
Black Nylon
Bumper Fascia Retainer
Pontiac Grand Am 1999 - On

UNIT PACKAGE: 15



11673
(GM: 2048248; Chry: 6003423)
Natural Nylon
Interior Trim Panel Retainer
GM & Chrysler 1977 - On

UNIT PACKAGE: 50



11351
(Ford: 385661-S;
Chry: 6032363; VW: N989022)
Black Nylon
Door Trim Panel Retainer
Ford, Chrysler & VW 1975 - On

UNIT PACKAGE: 25



23745
Charcoal Nylon
Trim Panel Retainer
Head Diameter: 1"
Stem Diameter: 5/16"
Stem Length: 25/32"
Panel Range: 0.080-0.532"

UNIT PACKAGE: 50



12571
(389443-S)
Black Nylon
Fascia to Bumper Retainer
Ford 1981 - On

UNIT PACKAGE: 25



21805
(Renault: 77-03-077-435)
Black Nylon

Retainer
Renault and Dacia

UNIT PACKAGE: 25



21806
(Renault: 77-03-077-225)
Black Nylon

Retainer
Renault and Dacia

UNIT PACKAGE: 25



20316
(Ford: 388904-S;
Chry: 4381395, 6501086)
Black Nylon
Door Frame Spacer Retainer
Replaces Auveco 14042
Chrysler 1985 - On
Bumper Retainer
Ford 1981 - On

UNIT PACKAGE: 50



20262
(22642756)
Black Nylon
Trunk Trim Retainer
Chevrolet Cavalier &
Pontiac Sunfire 1995 - On

UNIT PACKAGE: 25



20362
(15056810)
Black Nylon
Bumper Fascia Retainer
GM S & T Trucks 2002 - On

UNIT PACKAGE: 25



12766
(22512276)
Black Nylon
Front End Stone Shield Retainer
GM 1981 - On

UNIT PACKAGE: 25

16262
Same as 12766 except for **unit package** quantity

UNIT PACKAGE: 50

TRIMMING SUNDRIES & FASTENERS

Refer to Retainer Specification Chart on pages 510-523

Sec. 19



12137

(1619321)
Black Nylon

Radiator Apron Panel Retainer
GM 1977 - On

UNIT PACKAGE: 25

16263

Same as 12137 except for unit package quantity

UNIT PACKAGE: 50



18679

(20652520)
Gray Nylon

**Compensator Panel to
Quarter Panel Retainer**
Buick Century & Skylark, Cadillac
Fleetwood and Olds Calais 1992 - 83

UNIT PACKAGE: 25



15478

(GM: 1631564;
Ford: N804379S, W706358-S300)
Black Nylon

Bumper Fascia Retainer
Buick, Cadillac & Olds 1981 - On
Taurus & Sable 1986 - On

UNIT PACKAGE: 50



23966

(W709371-S300, 6506293AA)
Nylon

Fender Apron, Hood Insulator Retainer
Head Diameter: 25.4mm
Stem Diameter: 7.5mm
Stem Length: 22mm
Ford F150, Expedition,
Navigator 2007 - On
Chrysler 2005 - On
Dodge Pick-Up 2009 - On
Jeep Grand Cherokee 1999 - On
Commander, Compass, Patriot 2006 - On

UNIT PACKAGE: 50



18771

(6502104)
Black Nylon

**Headlight Mounting Panel to Cross
Member Sight Shield Retainer**
Dodge Daytona 1993

UNIT PACKAGE: 25



18680

(10229437, 10242316)
Black Nylon

Headliner Trim Finish Panel Retainer
Buick Skylark, Chevrolet Camaro,
Cavalier, Lumina & Monte Carlo,
Oldsmobile Cutlass and Pontiac Firebird,
Grand Am, Grand Prix & Sunfire 1992 - On

UNIT PACKAGE: 25



18688

(10220168, 10241518)
Gray Nylon

Headliner Trim Finish Panel Retainer
Buick Century & Regal, Chevrolet
Caprice, Camaro, Lumina & Monte Carlo,
Olds Cutlass Ciera and Pontiac Firebird &
Grand Prix 1992 - On

UNIT PACKAGE: 50



20345

(15006827)
Gray Nylon

Headliner Retainer
GM C & K Trucks 2000 - On

UNIT PACKAGE: 25



23896

(N805200-S)
Black Nylon

Headliner, Hood Insulation Retainer
Head Diameter: 32mm
Stem Diameter: 8.3mm
Stem Length: 20mm
Ford Thunderbird, Cougar 1987 - On
Explorer 1991 - On
Lincoln Continental 1995 - On

UNIT PACKAGE: 15



22338

(VW: 3C0-863-559)
Black Nylon

**Wheel House Cover Mount &
Interior Trim Retainer**
Volkswagen Passat &
CC 2012 - 2006

UNIT PACKAGE: 25



20625

(Ford: XW7Z-6302354-AAB)
Tan Nylon

Headliner Retainer
Ford Expedition & Navigator
2003 - On

UNIT PACKAGE: 25



12759

(14027471)
Black Nylon

Trim Panel Retainer
GM Trucks 1981 - On

UNIT PACKAGE: 25

TRIMMING SUNDRIES & FASTENERS

Refer to Retainer Specification Chart on pages 510-523



12909
(388930-S)
Black Nylon

Trim Panel Retainer
Ford 1980 - On

UNIT PACKAGE: 50



20874
(90467-07049-CO)
Black Nylon

Trim Panel Retainer
Lexus 2000 - On

UNIT PACKAGE: 25

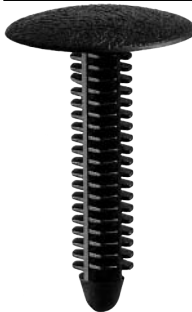

15479
(N804349S)
Black Nylon

Interior Trim Retainer
Ford 1986-On

UNIT PACKAGE: 25



21241
(Ford: W706635-SSW)
Black Nylon

Rocker, Pillar & Fender Liner, Headliner Retainer
Ford Fusion & Taurus 2009 - On,
Transit Connect 2014 - On,
Transit 150-350 2015 - On

UNIT PACKAGE: 50



22053
(Ford: W715951-S300)
Black Nylon

Rear Body & Interior Trim Retainer
Ford Escape 2013 - On

UNIT PACKAGE: 15

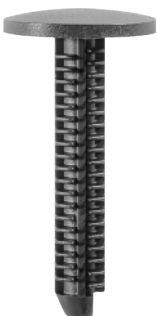

24162
(10140336, N808552-S)
Black Nylon

Door Panel & Wheel House Retainer
Head Diameter: 25/32"
Stem Diameter: 5/16"
Stem Length: 1-1/2"
GM "U" Van Bodies 1990 - On & Ford

UNIT PACKAGE: 50



19845
(E8FZ-5802354A)
Medium Graphite Nylon

Trim & Garnish Retainer
Ford Vans 1992 - On

UNIT PACKAGE: 25

19846
(F2UZ-1602354AAA)
Black Nylon

UNIT PACKAGE: 25



18277
(N806344-S)
Gray

Roof Trim Panel & Garnish Moulding Retainers
Ford Ranger 1992-On

UNIT PACKAGE: 25

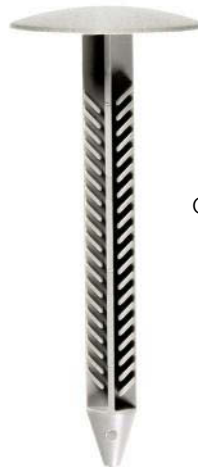

21287
(25822063)
Opal Gray Nylon

Headliner Retainer
Chevrolet Silverado Hybrid 2010 - On

UNIT PACKAGE: 25

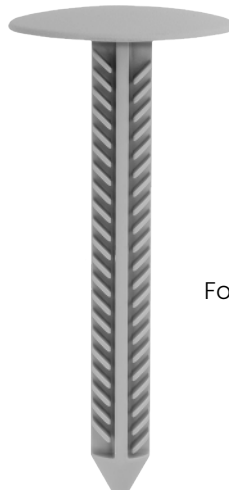

25182
(Ford: W717918-SS34X)
Grey Nylon

Headliner Retainer
Top Head Diameter: 30mm
Stem Diameter: 9.8mm
Stem Length: 63.5mm
Overall Height: 66mm
Ford Transit 150, 250, 350 2015 - On

UNIT PACKAGE: 15

TRIMMING SUNDRIES & FASTENERS

Refer to Retainer Specification Chart on pages 510-523

Sec. 19



22760
(Nissan: 01553-05891)
Dark Gray Nylon

Bumper Bracket Retainer
Head Diameter: 26mm
Stem Diameter: 8.6mm
Stem Length: 39mm
Nissan Altima 2013 - On

UNIT PACKAGE: 25



21288
(65846-4Z000)
Black Nylon

Hood Insulation Retainer
Nissan Altima 2010 - On

UNIT PACKAGE: 15



19468
(65846-40F00)
Black Nylon

Hood Insulation Retainer
Infiniti J30, M30 & Q45 1989 - On

UNIT PACKAGE: 15



21380
(15989431)
Black Nylon

Hood Insulation Retainer
Chevrolet Traverse 2010 - On

UNIT PACKAGE: 25



22211
(Subaru: 909207031)
Black Nylon

Hood Insulation Retainer
Subaru BRZ, Forester, Impreza,
WRX & XV Crosstrek 2012 - On

UNIT PACKAGE: 50



15998
(90700-SB2-003)
Black Nylon

Hood Insulation Retainer
Honda Prelude 1985 - On
UNIT PACKAGE: 15



21421
(909130074)
Black Nylon

Hood Insulation Retainer
Subaru Baja, Forester, Impreza,
Legacy, Outback & Tribeca 1998 - On
UNIT PACKAGE: 15



21443
(11571159)
Black Nylon

Hood Insulation Retainer
Chevrolet Cruze 2011 - On

UNIT PACKAGE: 25



21313
(Ford: W708633-S300)
Black Nylon

Hood Insulation Retainer
Ford Escape 2019 - 2013; Expedition 2017 - 2015;
F-150 2014 - 2009; F-250, F350, F450 F-550 2018 - 2017;
Fiesta 2018 - 2011; Flex 2019 - 2013; Bronco 2021 - On;
Fusion 2012 - 2010; Lincoln MKC 2019 - 2015;
MKZ 2012 - 2010; Mercury Milan 2011 - 2010

UNIT PACKAGE: 25



11842
(N-800387-S)
Black Nylon

Dashboard Retainer
Ford 1979 - On

UNIT PACKAGE: 25



11350
(4005250)
White Nylon

Door Panel Retainer
American Motors 1976 - On

UNIT PACKAGE: 25



17381
(N805315)
Gray Nylon

Headliner Retainer
Ford Aerostar 1986 - On

UNIT PACKAGE: 10



19338
(Chry: 6504098;
Ford: N808842-S; W705002-S300)
Black Nylon

Hood Insulation Retainer
Chrysler Sebring 1996 - On
Ford Escape 2012 - 2008, Expedition, F150,
Flex 2019 - 2009, Explorer 2019 - 2011, F250SD, F350SD,
F450SD, F550SD 2019 - 2008, Mustang 2019 - 2010,
Ranger 2019, Taurus 2008 - 1996;
Lincoln Continental 2019 - 2017, MKS 2016 - 2009, MKT
2019 - 2010, Mark LT 2014 - 2010, Mark VIII 1998 - 1997,
Navigator 2019 - 2007; Mercury Mariner 2011 - 2008,
Sable 2009 - 2008
UNIT PACKAGE: 50

TRIMMING SUNDRIES & FASTENERS

Refer to Retainer Specification Chart on pages 510-523



22233
(GM: 11611677)
Black Nylon

Hood Insulation Retainer
Cadillac ELR, Chevrolet Colorado & Volt and GMC Canyon 2011 - On

UNIT PACKAGE: 10



20541
(TY98TL2-AA)
Tan Nylon

Headliner Retainer
Chrysler Caravan, Town & Country and Voyager Mini-Vans 2001 - On

UNIT PACKAGE: 25



15457
(20030401)
Black Polypropylene

Hood Insulation Retainer
GM 1980 - On

UNIT PACKAGE: 25



15456
(20064875)
Black Nylon

Hood Insulation Retainer
GM 1980 - On

UNIT PACKAGE: 25



11130
(3078511, 3977775)
Black Nylon

Hood Insulation Retainer
GM 1964 - On

UNIT PACKAGE: 25



16863
(N803613S)
Black Nylon

Hood Insulation Retainer
Ford Bronco, Explorer & Ranger 1988 - On

UNIT PACKAGE: 25



15668
(N803387)
Black Nylon

Trim Panel Retainer
Ford

UNIT PACKAGE: 25



17215
(21039141)
Black Nylon

Hood Insulation Retainer
GM Saturn 1991 - On

UNIT PACKAGE: 25



21227
(25749564)
Tan Nylon

Headliner Retainer
Chevrolet Express Van & GMC Savana Van 2004 - On

UNIT PACKAGE: 15



22493
(Ford: W719084-S300)
Black Nylon

Trim Panel Retainer
Head Diameter: 18mm
Stem Diameter: 7.5mm
Stem Length: 45mm
Ford Mustang 2016 - On

UNIT PACKAGE: 25



18827
(6503892)
Black Nylon

Hood Insulation Retainer
Chrysler Cirrus & Stratus 1995 - On

UNIT PACKAGE: 50



19655
(386553-S)
Black Nylon

Hood Insulation Retainer
Replaces Auveco 13571
Ford 1975 - On

UNIT PACKAGE: 25



14163
(388908-S)
Black Nylon

Hood Insulation Retainer
Ford 1975- On

UNIT PACKAGE: 50

TRIMMING SUNDRIES & FASTENERS

Refer to Retainer Specification Chart on pages 510-523

Sec. 19



17975

(Chry: 6502842,
GM: 21039129)
Black Nylon

Hood Insulation Retainer
Chrysler Concorde, Dodge Intrepid
& Eagle Vision 1993 - On
GM Corvette, Equinox & Saturn 1992 - On

UNIT PACKAGE: 50



21211

(53326-08010)
Black Nylon

Hood Insulation Retaining Clip
Toyota Sienna 2009 - On

UNIT PACKAGE: 25



20164

(4878883AA)
Black Nylon

Hood Insulation Retainer
Chrysler LH & LHS Series 1997 - On

UNIT PACKAGE: 50



21652

(91501-SWA-003)
Black Nylon

Hood Insulation Retainer
Honda Civic 2012 - On

UNIT PACKAGE: 25



17004

(4341060)
Black Nylon

**Hood Insulation &
Fender Shield Retainer**
Chrysler 1985- On

UNIT PACKAGE: 25



19155

(4428987)
Black Nylon

Hood Insulation Retainer
Dodge Ram 1994 - On

UNIT PACKAGE: 25



17237

(Nissan: 65832-F5000
65846-30F00)
Black Nylon

Hood Insulation Retainer
Mercury Villager 1999 - On
Nissan 1981 - On

UNIT PACKAGE: 15



22898

(Nissan: F5846-30F00)
Black Nylon

Hood Insulation Retainer

Head Diameter: 30mm
Stem Diameter: 6mm
Stem Length: 10mm
Overall Height: 12mm

Infiniti JX35 & QX56 2013 - 2011, QX60 & QX80 2018 - 2014
Nissan Altima, Armada, Frontier, Kicks, Maxima, Murano,
NV200, Pathfinder, Quest, Rogue, Sentra,
Titan & Versa 2009 - On

UNIT PACKAGE: 25



18746

(90700-SJ4-000)
Black Nylon

Hood Insulation Retainer

Head Diameter: 30mm
Stem Diameter: 15mm x 18mm
Stem Length: 6mm
Acura Legend 1991 - On
Honda 1998 - On

UNIT PACKAGE: 15



20609

(91501-SIK-003, 91501-STK-003)
Black Nylon

Hood Insulation Retainer

Acura 3.5RL & RSX and
Honda Civic & CR-V 2000 - On

UNIT PACKAGE: 25



22168

(GM: 13265959)
Black Nylon

Hood Insulation Retainer

Cadillac Catera 2001 - 1997 &
Buick Regal 2011 - On

UNIT PACKAGE: 25



22103

(Toyota: 53857-47011)
Black Nylon

Front Fender Retainer with Sealer

Lexus CT 200h and Toyota Camry, Prius, RAV4,
Yaris & 4-Runner 2010 - On

UNIT PACKAGE: 15



13467

(GM: 7642589;
AMC: 4001934)
Black Nylon

Firewall Insulation Retainer

GM & AMC

UNIT PACKAGE: 25

TRIMMING SUNDRIES & FASTENERS

Refer to Retainer Specification Chart on pages 510-523



22509
(BMW: 07-14-7-296-886)
Black Nylon

Side Shield & Trim Retainer
Head Diameter: 24mm
Stem Diameter: 4mm
Stem Length: 23mm
T27 Drive
BMW 3 Series 2012 - On

UNIT PACKAGE: 25



23592
(389809, C6GY-16776-A)
Nylon

Hood Insulation Retainer
Head Size: 1-1/2" x 1-1/2"
Stem Diameter: 9/32"
Stem Length: 23/32"
GM & Ford

UNIT PACKAGE 50



13757
(389809)
Black Nylon

Hood Insulation Retainer
2" Square
GM 1980 - On

UNIT PACKAGE: 25



22553
(Honda: 90651-T2M-003)
Black Nylon

Weatherstrip Retainer
Head Size: 4mm x 10mm
Stem Diameter: 6.5mm
Stem Length: 7mm
Honda Accord & Clarity 2014 - On

UNIT PACKAGE: 25



22769
(Nissan: 80850-89916)
Black Nylon

Door Weatherstrip Retainer
Head Size: 4mm x 10mm
Stem Diameter: 5.4mm
Stem Length: 10mm
Infiniti I30 2001 - 1996
I35 2004 - 2002
Nissan Juke 2015 - 2011
Maxima 2003 - 1995

UNIT PACKAGE: 50



14985
(2664040)
White Nylon

Door Weatherstrip Retainer
Chrysler 1966 - On

UNIT PACKAGE: 100



24484
Green Nylon

Door Weatherstrip Retainer Head
Diameter: 5mm x 15mm
Stem Diameter: 5.6mm
Hole Size: 5mm
Stem Length: 9mm
Overall Length: 15mm
Chrysler Sebring & Dodge Stratus 2003 - On

UNIT PACKAGE: 50



21981
(VW: 1H0-823-717)
Black Nylon

Weatherstrip Retainer
VW, Audi, SEAT & Skoda

UNIT PACKAGE: 25



14299
(73862-672-003)
White Nylon

Weatherstrip Retainer
Honda

UNIT PACKAGE: 50



20182
(Not Available from O.E.M.)
White Nylon

Weatherstrip Retainer
Chrysler LH & LHS Series 1997 - On

UNIT PACKAGE: 100



18510
(20200750)
Natural Nylon

Hood Seal Retainer
Buick, Cadillac, Chevrolet,
GMC & Oldsmobile 1970 - On

UNIT PACKAGE: 100



23892
(22567463)
Black Plastic

Retainer Hood Seal Retainer
Stem Length: 16mm
Stem Diameter: 7.3mm
Head Diameter: 16mm
GM "N" Body 1992 - 1993

UNIT PACKAGE: 50

TRIMMING SUNDRIES & FASTENERS

Refer to Retainer Specification Chart on pages 510-523

Sec. 19



25339

(VW: 3B0-839-723)
Gray Nylon

Door Weatherstrip Clip

Head Size: 5mm x 11mm
Stem Diameter: 6.3mm
Stem Length: 9.5mm
Overall Height: 10.5mm
Fits into 6mm Hole

Volkswagen Golf, Jetta 2011-1999,
Passat 2005-1998, Rabbit 2004

UNIT PACKAGE: 50



25072

(Mazda: KD45-58-762)
White Nylon

Weatherstrip Retainer

Head Size: 5mm x 11mm
Stem Length: 10mm
Fits into 5mm Hole

Overall Height: 12mm
Mazda 3, 6 2014 - On; CX-3,
MX-5 Miata 2016 - On; CX-5 2010 - On

UNIT PACKAGE: 25



22321

(Hyundai: 86438-2T000)
Black Nylon

Hood & Bumper Seal Retainer

Hyundai Elantra &
Genesis 2013 - On
Kia K900 & Optima 2011 - On

UNIT PACKAGE: 50



22526

(Hyundai: 82133-37000)
Red Nylon

Weatherstrip Retainer

Head Size: 5mm x 13mm
Stem Diameter: 5.5mm
Stem Length: 6mm

Hyundai Accent, Elantra, Santa Fe &
Sonata 2006 - 1993

UNIT PACKAGE: 50



21382

(86434-4A000)
Black Nylon

Hood Seal Retainer

Hyundai Elantra, Sonata & Tucson
and Kia Sportage 2009 - On

UNIT PACKAGE: 50



22320

(Hyundai: 86438-1R000)
Black Nylon

Hood Seal Retainer

Hyundai Accent 2011 - On

UNIT PACKAGE: 50



22107

(Nissan: 80850-JM01A)
Black Nylon

Weatherstrip Retainer

Nissan Rogue 2008 - On

UNIT PACKAGE: 25



14328

(90664-671-003, 91530-SE0-003)
White Nylon

Weatherstrip Retainer

Honda

UNIT PACKAGE: 50



20180

(Not Available from O.E.M.)
Black Nylon

Weatherstrip Retainer

Chrysler LH & LHS Series 1997 - On

UNIT PACKAGE: 100



10744

(4876498)
Black Nylon

Weatherstrip Retainer

GM

UNIT PACKAGE: 100



19678

(Not Available from O.E.M.)
White Nylon

Weatherstrip Retainer

Ford Windstar 1995 - On

UNIT PACKAGE: 50



18509

(4040732)
Black Nylon

**Weatherstrip Retainer Hood Inner
Panel to Cowl & Door Weatherstrip**

Dodge F.W.D. Pick-Up 1989 - 82

UNIT PACKAGE: 100



21381

(86438-4A100)
Black Nylon

Hood Seal Retainer

Hyundai Elantra & Tucson and
Kia Forte & Sportage 2009 - On

UNIT PACKAGE: 50



19425

(385677)
Natural Nylon

Weatherstrip Retainer

Ford

UNIT PACKAGE: 50

TRIMMING SUNDRIES & FASTENERS

Refer to Retainer Specification Chart on pages 510-523



8853
(C5AB-6220586A)
Natural Nylon

Door Weatherstrip Retainer
Ford

UNIT PACKAGE: 50



21143
(51-71-1-496-621)
Black Nylon

Rocker Moulding Retainer
Mini-Cooper 2002 - On

UNIT PACKAGE: 25



19449
(10403591)
Black Nylon

Rear Bumper Fascia Retainer
Oldsmobile Intrigue &
Pontiac Grand Prix 1998 - On

UNIT PACKAGE: 25



22310
(Mercedes: 001-988-97-81)
White Nylon

Scuff Plate Retainer
Mercedes-Benz C230, C280, C350,
C55, CLK350, CLK500, CLK55, CLK63, S350 &
S430 2009 - 2006

UNIT PACKAGE: 25



19418
(GM: 480534;
Ford: 384051-S)
Black Nylon

Cowl Insulation Retainer
Splash Shield and Wire Retainer
GM; Ford

UNIT PACKAGE: 25



21125
(Not Available from O.E.M.)
Black Nylon

Front Bumper Retainer
Cadillac STS 2005 - On

UNIT PACKAGE: 15



21694
(Lexus: 67867-50020)
Black Nylon

Weatherstrip Retaining Clip
Lexus GS 300 &
LS 400 2005 - 1990

UNIT PACKAGE: 25



19325
(MU481027)
Brown Nylon

Hood Weatherstrip Retainer
Mitsubishi Eclipse & Diamante 1991 - On

UNIT PACKAGE: 25



21552
(90467-04034)
White Nylon

Weatherstrip Retainer
Lexus CT 200h, HS 250h, IS F, IS 250, IS 350, LS 460, LS
600h, RX 350, RX 400h & RX 450h and Toyota Avalon,
Corolla, Highlander, Matrix, Prius,
RAV-4, Scion & Venza 2003 - On

UNIT PACKAGE: 25



20760
(Not Available from O.E.M.)
Natural Nylon

Weatherstrip Retainer
Chrysler 300 & Dodge Magnum 2005 - On

UNIT PACKAGE: 100



19850
(N806340-S)
Natural Nylon

Weatherstrip Retainer
Ford F150 1999 - On

UNIT PACKAGE: 100



21565
(90331AA050)
White Nylon

Weatherstrip Retaining Clip
Subaru Forester 2008 - 2003

UNIT PACKAGE: 25



21334
(W711858-S300)
White Nylon

Weatherstrip Retainer
Ford Edge & MKX 2007 - On

UNIT PACKAGE: 100



22162
(Not Available From O.E.M.)
Orange Nylon

Weatherstrip Retainer
Ford Explorer 2014 - On

UNIT PACKAGE: 100

TRIMMING SUNDRIES & FASTENERS

Refer to Retainer Specification Chart on pages 510-523

Sec. 19



19481

(GA2A-58-762)
Blue Nylon

**Front & Rear Door
and Hood Weatherstrip**
Mazda 626 & Millenia 1995 - On

UNIT PACKAGE: 50



22875

(Nissan: 80850-1FA0B)
Natural Nylon

Door Weatherstrip Retainer
Top Head Size: 5mm x 15mm
Bottom Head Diameter: 8.5mm
Stem Size: 4.5mm x 7mm
Stem Length: 8.3mm
Nissan Cube 2014 - 2009
Juke 2017 - 2011

UNIT PACKAGE: 50



25065

(Acura & Honda: 90565-TZ5-003)
Black Nylon

Weatherstrip Retainer
Top Head Size: 4.7mm x 12mm
Bottom Head Diameter: 7mm
Stem Size: 4.5mm x 6.5mm
Stem Length: 7.5mm
Overall Height: 11.5mm
Fits into 5mm Hole
Acura MDX 2014 - On; Honda Accord 2018 - On;
Civic, Pilot, Ridgeline, CR-V 2016 - On; Insight,
Passport 2019 - On

UNIT PACKAGE: 25



22355

(Not Available From O.E.M.)
Green Nylon

**Fender Seal &
Weatherstrip Retainer**
Overall Height: 13.5mm
Ford Mustang 2015 - On

UNIT PACKAGE: 50



22356

(Not Available From O.E.M.)
Red Nylon

**Fender Seal &
Weatherstrip Retainer**
Overall Height: 13.5mm
Ford Mustang 2015 - On
UNIT PACKAGE: 50



20181

(Not Available from O.E.M.)
White Nylon

Weatherstrip Retainer
Chrysler LH &
LHS Series 1997 - On
UNIT PACKAGE: 100



22533

(GM: 11611342)
Natural Nylon

Weatherstrip Retainer
Top Head Size: 6.5mm x 14mm
Bottom Head Diameter: 9.5mm
Stem Diameter: 7mm
Stem Length: 8mm
Buick Cascada, Regal & Verano 2011 - On

UNIT PACKAGE: 100



25050

(GM: 11611664)
Green Nylon

Door Weatherstrip Retainer
Top Head Size: 6.5mm x 14mm
Bottom Head Diameter: 10mm
Stem Size: 4.7mm x 7mm
Overall Height: 12.5mm
Fits into 5mm Hole
Buick Envision 2018 - 2016;
Chevrolet Malibu 2016
UNIT PACKAGE: 25



19368

(10283414, 10405030)
Natural Nylon

Door Weatherstrip Retainer
Buick Century & Regal and
Oldsmobile Intrigue 1997 - On

UNIT PACKAGE: 100



21980

(VW: 1Z0-837-732A)
Yellow Nylon

Weatherstrip Retainer
VW, Audi, SEAT & Skoda

UNIT PACKAGE: 25



22302

(Not Available from O.E.M.)
Yellow Nylon

Weatherstrip Retainer
Overall Height: 12.5mm
Ford F-150 & Super Duty Trucks and Lincoln
Mark LT 2003 - On

UNIT PACKAGE: 50



22060

(Nissan: 65810-K2002)
Black Nylon

Hood Seal Retaining Clip
Infiniti 2003 - 1997
Nissan 2003 - 1996

UNIT PACKAGE: 25

TRIMMING SUNDRIES & FASTENERS

Refer to Retainer Specification Chart on pages 510-523



21229
(65810-K2000)
Black Nylon

Hood Seal Retaining Clip
Infiniti I30, I35, Q45 &
QX4 and Nissan Maxima &
Pathfinder 2004 - 1996

UNIT PACKAGE: 25



22325
(Hyundai: 87756-2W000)
Red Nylon

Weatherstrip Retainer
Hyundai Santa Fe &
Kia Sorento 2013 - On

UNIT PACKAGE: 100



20831
(Not Available from O.E.M.)
Blue Nylon

Weatherstrip Retainer
Ford Explorer 2005 - On

UNIT PACKAGE: 100



18692
(Ford: E7GZ-6120586-B;
Hyundai: 86438-2B000;
Mazda: G031-58-762;
Toyota: 67868-89101,
67867-28030, 67867-89103)
Natural Nylon

Weatherstrip Retainer
Toyota 4-Runner 1989-1983
Mazda 1996 - On; Ford 1996 - On
Hyundai 2007- On; Kia 2009 - On

UNIT PACKAGE: 50



24469
Nylon

Door & Hood Seals Weatherstrip Retainer
Head Diameter: 5mm x 15mm
Hole Size: 5.3mm
Stem Length: 7.5mm
Overall Length: 12.5mm
Ford & Lincoln

UNIT PACKAGE: 100



19171
(91568-SR2-003)
Green Nylon

Weatherstrip Retainer
Honda Odyssey 1995 - On

UNIT PACKAGE: 100



19749
(67867-12150)
White Nylon

Weatherstrip Retainer
Toyota Avalon 1995 - On

UNIT PACKAGE: 15



20443
(67867-0C010)
Black Nylon

Weatherstrip Retainer
Toyota Tundra 1999 - On

UNIT PACKAGE: 25



21773
(Honda: 91530-S0A-003)
Black Nylon

**Roof Rail & Side Sill
Weatherstrip Retainer**
Acura Legend, MDX, RDX, RL,
TL & ZDX 1998 - On
Honda Accord, Civic, CRV,
Element & Odyssey 2001 - On

UNIT PACKAGE: 25



21705
(Honda: 90651-TP8-003,
91568-TR0-003)
Yellow Nylon

Weatherstrip Retainer
Acura ILX & RDX and Honda Civic & CR-V 2012 - On

UNIT PACKAGE: 25



21707
(Honda: 91563-SCV-003)
(Toyota: 67867-52010,
67867-0D060)
White Nylon

Weatherstrip Retainer
Acura TL and Honda Element, Odyssey
& Pilot 2003 - On Toyota Echo, Land Cruiser,
Prius, Tacoma & Yaris and Lexus GS 450,
GX 460 & LX 430 and Scion xA & xD 2000 - On

UNIT PACKAGE: 25



21704
(Honda: 72311-S5S-003)
Green Nylon

Weatherstrip Retaining Clip
Acura RDX and Honda Civic,
CR-V & Fit 2003 - On

UNIT PACKAGE: 25

TRIMMING SUNDRIES & FASTENERS

Refer to Retainer Specification Chart on pages 510-523

Sec. 19



18877

(91530-SPI-003)
Orange Nylon

Weatherstrip Retainer
Acura 3.5 RL & Honda Accord,
Civic, & Odyssey 1992 - On

UNIT PACKAGE: 25



22337

(Hyundai: 82132-27100)
White Nylon

Door Weatherstrip Retainer
Hyundai Azera, Santa Fe &
Sonata 2001 - On, Tuscon 2021 - On

UNIT PACKAGE: 25



19116

(91530-ST5-003)
Natural Nylon

Weatherstrip Retainer
Honda Civic 1995 - On

UNIT PACKAGE: 10



25347

(Mitsubishi: MR380850)
White Nylon

Door Weatherstrip Clip with Sealer
Head Size: 5mm x 15mm
Stem Length: 10mm
Fits into 6mm Hole

Mitsubishi Outlander 2007, Montero 2000-1994

UNIT PACKAGE: 15



17339

(N806289-S)
Black Nylon

Weatherstrip Retainer
Lincoln 1989 - On

UNIT PACKAGE: 50



19684

(01553-09311)
Blue Nylon

Weatherstrip Retainer
Nissan Altima & Sentra 1994 - On

UNIT PACKAGE: 25



21949

Black Nylon

Weatherstrip Retainer
Peugeot & Citroen

UNIT PACKAGE: 25



18033

(Chry: 4696129;
GM: 21077575)
White Nylon

Weatherstrip Retainer
Chrysler Concorde & LHS
Dodge Intrepid &
Eagle Vision 1993 - On
Oldsmobile Alero &
Pontiac Grand Am 1999 - On

UNIT PACKAGE: 50



22551

(Honda: 90651-TA0-003)
Natural Nylon

Door Panel & Weatherstrip Retainer

Top Head: 5mm x 12mm
Bottom Head Diameter: 12mm
Stem Diameter: 6mm
Stem Length: 4.5mm

Acura ILX, MDX, RDX, RLX & ZDX 2010 - On
Honda Accord, CR-V, Pilot, Ridgeline 2008 - On

UNIT PACKAGE: 50



21633

(80850-89900)
White Nylon

Weatherstrip Retainer
Infiniti I30, I35 & M45 and
Nissan Maxima 2004 - 2000

UNIT PACKAGE: 25



19683

(91502-S84-A11)
Black Nylon

Cowl Vent Retaining Clip
Honda Odyssey 1999 - On

UNIT PACKAGE: 15



19728

(90467-10146)
Black Nylon

Cowl Panel Retainer
Toyota Sienna Van 1997 - On

UNIT PACKAGE: 25

TRIMMING SUNDRIES & FASTENERS

Refer to Retainer Specification Chart on pages 510-523



19724
(65810-K2009)
White Nylon

Hood to Cowl Seal Retainer
Infiniti & Nissan Pathfinder 1992 - On

UNIT PACKAGE: 25



19483
(91515-SR3-000)
Black Nylon

Rear Hood Cowl Weatherstrip Retaining Clip
Acura Integra, Honda Civic, CR-V & Del Sol 1992 - On

UNIT PACKAGE: 25



18508
(4001916)
Black Nylon

Weatherstrip Retainer
Jeep Wrangler 1991 - On

UNIT PACKAGE: 50



11136
(Ford: 385330-S, D30Z-16776-A; Chry: 6003351)
Black Nylon

Hood Insulation Retainer
Chrysler 1972 - On
Grille to Radiator Retainer
Ford 1973 - On

UNIT PACKAGE: 25



18166
(80875-85E00)
Black Nylon

Trim Panel Retainer
Nissan Maxima 1989 - On

UNIT PACKAGE: 25



18818
(91513-SE0-003)
Natural Nylon

Hood Seal Retainer
Honda Accord & Prelude 1983 - On

UNIT PACKAGE: 25



21918
(Peugeot & Citroen: 9025.J8)
Black Nylon

Weatherstrip Retaining Clip
Peugeot, Citroen, Renault & Dacia

UNIT PACKAGE: 25



21920
Black Nylon

Weatherstrip Retaining Clip
Peugeot, Citroen, Renault & Dacia

UNIT PACKAGE: 25



21295
(01553-08961)
Black Nylon

Weatherstrip Retaining Clip
Nissan Altima 2009 - On

UNIT PACKAGE: 25



3639
(CIAB-6220807-A)
White Nylon

Door Flange Weatherstrip Retainer
Ford

UNIT PACKAGE: 100



3620
(4801268)
Black Nylon

Door Flange Weatherstrip Retainer
GM

UNIT PACKAGE: 100



18248
(55055098)
Black Nylon

Headlight Grille Retaining Clip
Dodge Ram 1994 - On

UNIT PACKAGE: 25



21573
(90331GA090)
Black Nylon

Weatherstrip Retaining Clip
Subaru Forester & Legacy 2008 - 1990

UNIT PACKAGE: 25



21943
(Peugeot & Citroen: 8749.Q5)
Gray Nylon

Trim Retaining Clip
Peugeot & Citroen

UNIT PACKAGE: 25

TRIMMING SUNDRIES & FASTENERS

Refer to Retainer Specification Chart on pages 510-523

Sec. 19



14355
(01533-00401)
Black Nylon

Retaining Clip
Nissan

UNIT PACKAGE: 50



14291
(66435-648-000)
Black Nylon

Retaining Clip
Honda

UNIT PACKAGE: 50



14349
(Mazda: 9926-40-543;
Nissan: 01553-00291)
Black Nylon

Retaining Clip
Mazda & Nissan

UNIT PACKAGE: 50



5592
(375372-S)
Black Nylon

Radiator Top Shield Retainer
Ford

UNIT PACKAGE: 100



23752
(76913-N9900)
Black

Trim Panel Retaining Clip
Head Diameter: 12mm
Stem Diameter: 6.5mm
Stem Length: 15mm
Nissan

UNIT PACKAGE: 50



19467
(91501-SL4-003)
Black Nylon

Front Cowl Retaining Clip
Acura 3.5 RL 1996 - On

UNIT PACKAGE: 25



22214
(Lexus: 90467-06015-C0)
Black Nylon

**Front & Rear Bumper
Retaining Clip**
Lexus GS 300, GS 400 &
GS 430 2005 - 1998

UNIT PACKAGE: 25



21626
(90467-06128)
Black Nylon

**Weatherstrip
Retaining Clip**
Toyota Camry & RAV-4 1992 - On

UNIT PACKAGE: 25



21296
(90080-46010)
Black Nylon

Hood Seal Retaining Clip
Toyota Camry 2010 - On

UNIT PACKAGE: 50



18297
(Toyota: 90467-08004, 90467-08011;
GM: 94842841, 94849113)
Black Nylon

Hood Seal Retaining Clip
Lexus, Toyota, Geo Prizm
& Nova 1985 - On

UNIT PACKAGE: 50



21695
(Toyota: 90467-08045,
90467-08063)
Black Nylon

**Hood & Weatherstrip
Retaining Clip**
Toyota Yaris 2007 - On

UNIT PACKAGE: 25



23737
(01553-00541)
Black Nylon

Trim Panel Retaining Clip
Head Diameter: 12mm
Stem Diameter: 6.5mm
Stem Length: 14mm
Nissan

UNIT PACKAGE: 50

TRIMMING SUNDRIES & FASTENERS

Refer to Retainer Specification Chart on pages 510-523



14352
(76876-W5000)
Black Nylon

Retaining Clip
Nissan

UNIT PACKAGE: 50



14737
(Nissan: 01553-00172;
Toyota: 90467-07050, 90467-08008)
Black Nylon

Retaining Clip
Nissan & Toyota

UNIT PACKAGE: 25



14282
(90687-SA5-003)
Black Nylon

Retaining Clip
Honda

UNIT PACKAGE: 50



17452
(01553-00545)
Black Nylon

Bumper Fascia Retainer
Nissan Sentra 1990 - On

UNIT PACKAGE: 25



22212
(Toyota: 53145-60030)
Black Nylon

**Front Bumper, Grille &
Hood Seal Retaining Clip**

Toyota Avalon, Camry, Highlander,
Land Cruiser, Prius & Venza and Lexus
GS 350, GS 450h, IS 250, IS 350, LX 570, NX 200t, NX 300h,
RX 350 & RX 450h and Scion iQ & tC 2008 - On

UNIT PACKAGE: 100



22001
(Toyota: 90467-08030)
Black Nylon

Trim Retaining Clip
Toyota

UNIT PACKAGE: 25



21643
(Toyota: 90467-08101, 90467-08108)
Black Nylon

**Hood to Cowl Top Seal
Retaining Clip**

Lexus ES 300, Toyota Camry 2001 - 1997,
Cressida 1992 - 1989, Sequoia 2007 - 2001,
Solara 2009 - 1999, Tundra 2006 - 1997,
4Runner 2010 - On, Corolla 2008 - 1998,
FJ Cruiser 2014 - 2007, Highlander 2013 - 2008,
Land Cruiser 2020 - 1998, Matrix 2008 - 2003,
Prius 2009 - 2004, Sienna 2020 - 2011

UNIT PACKAGE: 25



18157
(90672-671-003)
Gray Nylon

**Headliner & Cowl Grille
Retaining Clip**

Honda Accord 1986 - On

UNIT PACKAGE: 25



23807
(8-94133167-0)
Black Plastic

Cowl Screen Retainer

Hole: M3.5

Stem Length: 13mm

Head Diameter: 8.0mm

GM Spectrum & Isuzu 1985 - On

UNIT PACKAGE: 100



14736
(90467-06161-01)
Black Nylon

Retaining Clip
Toyota

UNIT PACKAGE: 25



19331
(MB869072)
Black Nylon

Headliner & Trunk Trim Retaining Clip

Mitsubishi Diamante 1995 - 1991

UNIT PACKAGE: 15



18271
(9926-40-531B)
Black Nylon

Hood Insulation Retainer

Mazda

UNIT PACKAGE: 25

TRIMMING SUNDRIES & FASTENERS

Refer to Retainer Specification Chart on pages 510-523

Sec. 19



20381

(Honda: 90667-671-013ZA;
Mitsubishi: MC440901;
Nissan: 62660-48600-1)
Black Nylon

Trim Panel Retaining Clip
Honda, Mitsubishi & Nissan

UNIT PACKAGE: 25



19123

(90467-10107)
Black Nylon

Fender Apron Seal Clip
Toyota 2WD & 4WD Truck 1988 - On

UNIT PACKAGE: 10



21634

(90467-10186)
Black Nylon

Dash & Fender Apron Seal Retainer
Lexus and Toyota 1996 - On

UNIT PACKAGE: 25



22221

(Toyota: 90080-46327)
Black Nylon

Fender Apron Seal Retainer
Toyota Sequoia, Tacoma
& Tundra 2000 - On

UNIT PACKAGE: 50



22286

(Nissan: 80287-37F00)
Natural Nylon

**Front Door, Garnish &
Interior Trim Retaining Clip**
Overall Height: 11.5mm
Infiniti FX35, FX45, G35, G37 &
Q60 and Nissan Murano 2015 - 2003

UNIT PACKAGE: 25



22263

(Honda: 91504-TBA-A01)
Black Nylon

Grille Retaining Clip
Honda Civic 2016 - On

UNIT PACKAGE: 25



20882

(91501-SEA-003)
Black Nylon

Cowl & Garnish Retainer
Honda Civic 2006 - On

UNIT PACKAGE: 10



22054

(Honda: 91501-SNA-003)
Black Nylon

**Front Fender, Cowl &
Dash Retainer**
Honda Civic & CR-V 2014 - 2006

UNIT PACKAGE: 15



20671

(Nissan: 01553-0052U,
01553-09001)
Black Nylon

Trim Panel Retaining Clip
Nissan Frontier 2004 - 1998;
Maxima 2003 - 2000;
NV200 2013 - On;
Sentra 2000 - 1998;
Versa 2012 - On; 200SX 1998 - 1995

UNIT PACKAGE: 25



22782

(BMW: 51-48-9-119-216,
51-48-7-273-379)
Black Nylon

Hood Insulator Retainer
Head Diameter: 21mm
Stem Diameter: 10.8mm
Stem Length: 9.5mm
BMW 230i, 320i, 328d, 330e,
330i, 330i GT, 340i, 340i GT, 430i,
430i Gran Coupe, 440i,
440i Gran Coupe & 530e 2018 - On
Mini-Cooper & Countryman 2015 - On

UNIT PACKAGE: 50



21757

(BMW: 51-48-8-181-420)
Black Nylon

Trim Panel & Trunk Lining Retainer
3 Series & 5 Series 2004 - 1988

UNIT PACKAGE: 25



19729

(90467-09050, 90467-A0003)
Black Nylon

Hood Insulation Retainer
Lexus, Toyota Camry &
Solara 1998 - On

UNIT PACKAGE: 15



19113

(90467-08124)
Black Nylon

Hood Insulation Retainer
Toyota Supra 1993 - On
Lexus 1994 - 1989

UNIT PACKAGE: 15

TRIMMING SUNDRIES & FASTENERS

Refer to Retainer Specification Chart on pages 510-523



19323
(MU481187)
Black Nylon

Hood Insulation Retainer
Mitsubishi Diamante 1993 - On

UNIT PACKAGE: 15



25185
(Nissan: 01553-06753)
Black Nylon

Interior Trim Panel Retaining Clip
Head Diameter: 20mm
Stem Diameter: 10mm
Stem Length: 18mm
Overall Height: 20mm
Nissan NV200 2013 - On

UNIT PACKAGE: 10

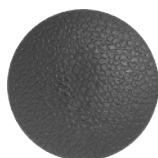

22082
(Mitsubishi: MB655630)
Black Nylon

Hood Insulation Retainer
Mitsubishi Diamante &
Montero 2004 - 1992

UNIT PACKAGE: 15



18878
(90467-08081)
Black Nylon

Hood Insulation Retainer
Toyota Celica 1993 - 1989

UNIT PACKAGE: 15



19112
(90467-09004)
Black Nylon

Hood Insulation Retainer
Toyota Tacoma 1995 - On

UNIT PACKAGE: 15



14738
(90467-09008)
Black Nylon

Retaining Clip
Toyota

UNIT PACKAGE: 25



18842
(90467-09006)
Black Nylon

Hood Insulation Retainer
Toyota Avalon, Camry &
Lexus 1988 - On

UNIT PACKAGE: 15



21588
(80850-CA003)
Black Nylon

Weatherstrip Retainer
Nissan Murano & Rouge 2003 - On

UNIT PACKAGE: 25



21307
(BP4K-58-762)
Black Nylon

Weatherstrip Retaining Clip
Mazda 2007 - On

UNIT PACKAGE: 25



18114
(91520-SM4-C01)
Black Nylon

Hood Insulation Retaining Clip
Honda & Acura 1990 - On

UNIT PACKAGE: 25



20770
(Not Available from O.E.M.)
Yellow Nylon

Weatherstrip Retainer
Ford F Series Pick-Ups 2004 - On

UNIT PACKAGE: 100



19682
(91518-S10-003)
Black Nylon

Hood Seal Retaining Clip
Honda Odyssey 1999 - On

UNIT PACKAGE: 25



19114
(91518-SM4-003)
Black Nylon

**Hood & Trunk
Moulding Retaining Clip**
Acura Integra &
Honda Civic 1994 - On

UNIT PACKAGE: 10



25328
(Honda: 91532-SJA-003)
Black Nylon

Fender Garnish Molding & Hood Seal Clip
Bottom Head Diameter: 11mm
Stem Size: 5mm x 7mm
Stem Length: 10mm
Overall Height: 11mm
Acura NSX 2020 - 2017, RL 2012 - 2005,
TLX 2020 - 2018; Honda CR-V 2016 - 2012

UNIT PACKAGE: 50

TRIMMING SUNDRIES & FASTENERS

Refer to Retainer Specification Chart on pages 510-523

Sec. 19



22541

(Honda: 91563-TG7-A00;
Ford: W712792-S300)
Black Nylon

Weatherstrip Retainer

Head Diameter: 12mm
Stem Diameter: 8mm
Stem Length: 10mm
Acura NSX 2017 - On

Honda CR-V, Pilot & Ridgeline 2016 - On ; Ford Bronco Sport 2021 - On, Edge 2015 - On, Escape 2020 - On, Expedition 2021 - 2018, Explorer 2021 - 2020, Flex 2019 - 2009, Fusion 2020 - 2013; Lincoln Aviator 2020 - On, Continental 2020 - 2017, Corsair 2021 - 2020, MKX 2018 - 2016, MKZ 2020 - 2013, Nautilus 2020 - 2019

UNIT PACKAGE: 100



21520

(J001-56-741)
Black Nylon

Weatherstrip Retaining Clip

Mazda CX-7, Millenia,
MPV, 3, 6 & 626 1995 - On

UNIT PACKAGE: 25



18458

(Ford: FICZ-16774-A;
Mazda: B455-56-741)
Black Nylon

Hood Insulation Retaining Clip

Ford Probe &
Mazda MX6 1992 - 1988

UNIT PACKAGE: 25



21497

(1H0-837-719)
Black Nylon

**Weatherstrip Retainer
with Clear Grommet**

Audi A3 and VW Golf, Sharan,
Transporter & Corsa

UNIT PACKAGE: 25



14723

(62869-N4700)
Black Nylon

Retaining Clip

Nissan

UNIT PACKAGE: 25



17205

(91501-SM4-003)
Black Nylon

Cowl Top Retaining Clip

Honda Accord 1990 - On

UNIT PACKAGE: 15



14353

(76906-T3000)
Black Nylon

Retaining Clip

Nissan

UNIT PACKAGE: 50



22046

(Subaru: 91167FA010)
Black Nylon

Front Hood Cowl Retaining Clip

Impreza 2001 - 1993

UNIT PACKAGE: 25



19124

(90467-07096)
Black Nylon

Side Trim Panel Retaining Clip

Toyota 4WD Truck 1989 - On

UNIT PACKAGE: 10



14347

(Nissan: 01553-00202;
Toyota: 90467-10018)
Black Nylon

Retaining Clip

Nissan & Toyota

UNIT PACKAGE: 50



14323

(38529-689A-6300)
Black Nylon

Retaining Clip

Honda

UNIT PACKAGE: 25

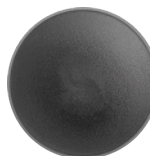

25076

(Lexus & Toyota: 90467-09051)
Black Nylon

Undercover Retainer

Head Diameter: 20mm
Stem Size: 5mm x 8mm
Stem Length: 10mm
Overall Height: 12mm
Fits into 6mm Hole

Lexus GS 200t 2016; GS 300 2019 - 2018;
GS 350 2013 - On; GS 430 20007 - 2006;
GS 450h 2018 - 2013; GS 460 2011 - 2008;
IS 200t 2017 - 2016; IS 250 2015 - 2006;
IS 300 2016 - On; IS 350 2006 - On; LS 460 2017 - 2007;
LS 600hL 2016 - 2008; RC 200t 2016;
RC 300 2016 - On; RC 350 2015 - On;
Toyota Corolla 1987 - 1984

UNIT PACKAGE: 25

TRIMMING SUNDRIES & FASTENERS

Refer to Retainer Specification Chart on pages 510-523



16779
(Honda: 74842-659-0030;
Toyota: 90467-12078)
Black Nylon

Retaining Clip
Honda & Toyota

UNIT PACKAGE: 25



14720
(HB-121467)
Black Nylon

Retaining Clip
Mitsubishi

UNIT PACKAGE: 25



22071
(GM: 11546805)
Black Nylon

Front Fender Retainer
Chevrolet Colorado 2015 - On

UNIT PACKAGE: 50



21105
(001-988-03-25)
Black Nylon

Hood Insulation Retainer
Mercedes 2002 - On

UNIT PACKAGE: 15



21254
(90467-08136)
Black Nylon

Fender Seal Retaining Clip
Toyota Yaris 2009 - On

UNIT PACKAGE: 25



14356
(01553-00051)
Black Nylon

Retaining Clip
Nissan

UNIT PACKAGE: 50



14319
(90687-671-003)
Black Nylon

Retaining Clip
Honda

UNIT PACKAGE: 25



22209
(Chrysler: 68033045AA)
Black Nylon

Front & Rear Fender Flare Retainer
Jeep Wrangler 2007 - On

UNIT PACKAGE: 15



20543
(81126-37010)
Black Nylon

Hood Insulation Retainer
Hyundai Elantra & Sonata
and Kia Optima 1995 - On

UNIT PACKAGE: 15



22254
(Mercedes-Benz: 000-991-74-98)
Black Nylon

Rocker Moulding Retaining Clip
Mercedes-Benz C, Cla, Cls, E,
Gla & S Class 2015 - On

UNIT PACKAGE: 15



22073
(Toyota: 76924-47020)
Black Nylon

Moulding Retainer
Lexus CT 200h & Toyota Prius 2011 - On

UNIT PACKAGE: 15



25346
(Lexus & Toyota: 90467-22017)
Black Nylon

Rocker Moulding Retainer
Head Diameter: 32mm
Stem Size: 14mm x 21.5mm
Stem Length: 13.5mm
Fits into 22mm Hole
Lexus NX350h 2022 - On;
Toyota RAV4 2019 - On,
Venza 2021-On

UNIT PACKAGE: 25



21551
(67869-12050)
Black Nylon

Weatherstrip Retainer
Toyota Corolla &
Prius 2007 - 01

UNIT PACKAGE: 25

TRIMMING SUNDRIES & FASTENERS

Refer to Retainer Specification Chart on pages 510-523

Sec. 19



25257

(MAZDA: KD53-50-M38)
Green Nylon

Pillar Retainer with Sealer
Top Head Diameter: 7mm
Bottom Head Diameter: 10mm
Stem Diameter: 5.8mm
Stem Length: 15mm
Fits into 6mm Hole

Mazda 3, 6, CX-5 2015 - On,
CX-3, CX-9 2016 - On, CX-30 2020 - On

UNIT PACKAGE: 25



25351

(Chrysler: 68499019AA)
Yellow Nylon

Rear Wheel Opening Spat Clip

Top Head Diameter: 9mm
Bottom Head Diameter: 11mm
Stem Size: 5.75mm x 10mm
Stem Length: 10mm
Overall Height: 15mm
Ram 1500 2019 - On

UNIT PACKAGE: 50



22994

(GM: 11602522)
White Nylon

Door Trim Applique Clip

Top Head Diameter: 10mm
Bottom Head Diameter: 10mm
Stem Diameter: 4.4mm x 7mm
Stem Length: 8mm
Overall Height: 12.5mm
Chevrolet Silverado &
GMC Sierra 2019 - On

UNIT PACKAGE: 50



25085

(GM: 11603260)
Orange Nylon

Door Trim Applique Clip

Top Head Diameter: 10mm
Bottom Head Diameter: 10mm
Stem Size: 4.4mm x 7mm
Stem Length: 8mm
Overall Height: 12.5mm
Chevrolet Silverado & GMC Sierra 2020 - On

UNIT PACKAGE: 50



21509

(357-853-575)
White Nylon

**Retainer
With Gray Grommet**
VW Golf, Jetta,
Passat & Scirocco

UNIT PACKAGE: 25



20611

(90602-S7S-003)
Blue Nylon

Cowl Vent Retainer
Honda Accord 2003 - On

UNIT PACKAGE: 25



25337

(Lexus & Toyota: 76829-60020)
Green Nylon

Interior Trim Panel Retainer
Top Head Diameter: 13mm
Bottom Head Diameter: 16mm
Stem Diameter: 3.7mm
Stem Length: 11.5mm
Overall Length: 16mm

Lexus NX300 2015 - On; Toyota RAV4 2019 - On,
Highlander 2020, Venza 2021 - On

UNIT PACKAGE: 50



21696

(Honda: 90602-S2A-003)
Pale Yellow Nylon

Cowl Retainer

Honda Civic, Element, Fit, Insight & S2000 2001 - On

UNIT PACKAGE: 25



23961

(96057293, 83943-86000)
White Nylon

Cowl Vent Retainer

Hole: M7
Head Diameter: 12 x 15mm
Geo Tracker 1999 - On; Suzuki Vitara 1999 - On

UNIT PACKAGE: 25



22819

(Mini-Cooper: 51-46-7-453-747)
White Nylon

Exterior Grille Trim Retainer
Top Head Diameter: 10mm
Bottom Head Diameter: 12mm
Stem Diameter: 8mm
Stem Length: 9mm
Mini-Cooper, Countryman,
Works & S 2013 - On

UNIT PACKAGE: 25



22789

(BMW: 51-13-7-065-607)
White Nylon

Liftgate Trim Retainer with Sealer

Top Head Diameter: 10mm
Bottom Head Diameter: 18mm
Stem Diameter: 10mm
Stem Length: 12mm
BMW 325xi, 328i & 328xi 2012 - 2006

UNIT PACKAGE: 25

TRIMMING SUNDRIES & FASTENERS

Refer to Retainer Specification Chart on pages 510-523



22862
(BMW: 51-49-7-054-228)
White Nylon

Trunk Trim Retainer
Top Head Diameter: 13mm
Bottom Head Diameter: 18mm
Stem Diameter: 9mm
Stem Length: 12.5mm
BMW 325xi, 328d, 328i, 328xi, 330i,
745Li, 745i, 750Li, 750i, 760Li,
760i & X3 2017 - 2003

UNIT PACKAGE: 25



20576
(GM: 88969790;
Toyota: 75867-21010)
Yellow Nylon

Fender Flare Retainer
Pontiac Vibe &
Toyota Echo 2002 - On

UNIT PACKAGE: 25



21975
(Peugeot & Citroen: 6991.43;
Renault & Dacia: 77-03-077-059)
White Nylon

Trim Panel Retainer
Peugeot, Citroen, Renault & Dacia

UNIT PACKAGE: 25



21871
(Peugeot & Citroen: 6995.A3;
Renault & Dacia: 77-03-077-111)
White Nylon

Trim Panel Retainer with Sealer
Peugeot, Citroen,
Renault & Dacia

UNIT PACKAGE: 25



22153
(Land Rover: LR032984)
White Nylon

Front Door Louver Exterior Trim Retainer with Sealer
Land Rover Evoque, HSE &
Range Rover 2014 - 2012

UNIT PACKAGE: 15



20571
(MR435918)
White Nylon

Rocker Panel Retainer
Mitsubishi Montero 2001 - On

UNIT PACKAGE: 15



20642
(000-990-57-92)
Gray Nylon

Door Panel Retaining Clip
Mercedes-Benz

UNIT PACKAGE: 10



19320
(MB696120)
White Nylon

Side Garnish & Moulding Trim Retainer
Mitsubishi Eclipse 1994 - On

UNIT PACKAGE: 15



21496
(357-853-585-A)
White Nylon

Trim Panel Retainer With Nylon Grommet
VW Golf & Passat and Audi B3

UNIT PACKAGE: 15



25334
(Land Rover: DYC500010)
Black Nylon

Wheel Flare Retainer
Top Head Diameter: 13mm
Bottom Head Diameter: 16mm
Stem Size: 8mm x 13mm
Stem Length: 12.5mm
Overall Height: 22mm
Land Rover LR3 2009-2005, LR4 2016-2010

UNIT PACKAGE: 25



18861
(90467-10162)
White Nylon

Scuff Plate Retainer
Toyota Celica 1993 - On

UNIT PACKAGE: 15



22243
(Honda: 91560-S04-003)
White Nylon

Side Panel Moulding Retainer
Honda Accord 2015 - 1998
Honda Civic 2011 - 2007

UNIT PACKAGE: 25



22057
(BMW: 51498123832;
51490151605; 5149810579)
Black Nylon

Trim Panel Retainer
BMW 3, 5, 6, 7, 8, X &
Z Series 2012 - 1989

UNIT PACKAGE: 25

TRIMMING SUNDRIES & FASTENERS

Refer to Retainer Specification Chart on pages 510-523

Sec. 19



21488
(11610605)
Gray Nylon

Door Trim Panel Retainer
Chevrolet Cruze 2011 - On

UNIT PACKAGE: 25



22240
(GM: 11546588)
Yellow Nylon

**Trim Panel Retainer
With Sealer**
Chevrolet Colorado &
GMC Canyon 2015 - On

UNIT PACKAGE: 15



21365
(13252118)
Blue Nylon

Door Panel Retainer
Cadillac, Chevrolet &
GMC 2010 - On

UNIT PACKAGE: 25



22462
(Mitsubishi: MU000977)
Blue Nylon

Rocker Moulding Retainer
Top Head Diameter: 13mm
Bottom Head Diameter: 18mm
Stem Diameter: 9.8mm
Stem Length: 9mm
Mitsubishi Mirage 2014 - On

UNIT PACKAGE: 25



19719
(67921-32010)
White Nylon

Scuff Plate Retainer
Toyota Avalon, Camry
& Corolla 1997 - On

UNIT PACKAGE: 15



20881
(5482103)
White Nylon

**Cowl Vent Retainer
with Sealer**
Chevrolet Equinox &
Pontiac Torrent 2005 - On

UNIT PACKAGE: 10



22252
(Mercedes-Benz: 000-991-63-98;
000-991-63-98-M22)
Yellow Nylon

**Door Garnish Moulding
Retainer with Sealer**
Mercedes-Benz G1450, G1550,
M1320, M1550, R63, R320,
R350 & R500 2010 - 2006

UNIT PACKAGE: 15



22236
(Mercedes: 006-988-43-78)
White Nylon

**Tailgate Garnish
Retainer with Sealer**
Mercedes-Benz C Class,
CLK Class, E Class, SL Class
& SLK Class 1996 - On

UNIT PACKAGE: 25



21495
(7L5-853-994)
Blue Nylon

Trim Panel Retainer
VW, Audi & Renault

UNIT PACKAGE: 25



21450
(703-867-299)
Black Nylon

**Side Panel &
Interior Trim Retainer**
VW 2003 - 1993

UNIT PACKAGE: 25



22179
(Ford: W718033-S300)
Black Nylon

**Rear Bumper
Retainer with Sealer**
Ford Edge 2015 - On

UNIT PACKAGE: 10



21567
(909130007)
Gray Nylon

**Pillar & Door Moulding
Trim & Rear Light
Retainer with Sealer**
Subaru B9 Tribeca, Forester, Impreza,
Legacy & Outback 2005 - On

UNIT PACKAGE: 25



21591
(909130109)
Black Nylon

**Front & Rear Door, Fender,
Quarter Panel and Rocker Panel
Moulding Clip**
Subaru B9 Tribeca, Forester, Impreza,
Legacy & Outback 2003 - On

UNIT PACKAGE: 25

TRIMMING SUNDRIES & FASTENERS

Refer to Retainer Specification Chart on pages 510-523



22133

(Not Available from O.E.M.)
Red Nylon

Fender & Pillar Moulding Retainer with Sealer
Ford Edge & Lincoln MKX 2007 - On

UNIT PACKAGE: 10



25117

(Volvo: 8659732)
Orange Nylon

Fender Flare Retainer
Top Head Diameter: 15mm
Bottom Head Diameter: 16mm
Stem Diameter: 8mm
Stem Length: 11mm
Overall Height: 15.5mm

Volvo S60, V60 2018 - 2016, V70 2010 - 2001,
XC60 2013 - 2009, XC70 2016 - 2003,
XC90 2014 - 2003

UNIT PACKAGE: 25



22207

(Subaru: 909130088)
Black Nylon

Fender, Rocker, Garnish, Pillar, Floor & Exterior Trim Retainer with Sealer
Subaru Forester, Impreza, Legacy, Outback, B9 Tribeca & WRX 2005 - On

UNIT PACKAGE: 25



21012

(75867-AA010)
Black Nylon

Rocker Panel & Scuff Plate Retainer
Lexus ES300 & ES330 2002 - On
Toyota Avalon, Camry, Scion & Solara 2004 - On

UNIT PACKAGE: 15



21107

(90602-SX0-003)
White Nylon

Cowl Vent Retainer
Acura MDX, Honda Civic, Insight, Odyssey & Prelude 1995 - On

UNIT PACKAGE: 10



21538

(75867-33030)
Charcoal Nylon

Overall Length: 18.5mm
Avalon, Camry, Prius, Scion, Sienna, Solara & Venza 2000 - On

UNIT PACKAGE: 25



20672

(66820-3S500-C1)
White Nylon

Cowl Vent Retainer
Nissan Frontier & Xterra 1998 - On

UNIT PACKAGE: 25



21088

(90321122)
White Nylon

Door Panel Retainer
Saturn Ion 2003 - On

UNIT PACKAGE: 50



22063

(Nissan: 01553-02903)
White Nylon

Front Side Lower Fender Panel Bracket Retainer
Overall Length: 21mm
Infiniti Qx4 & Qx56 and Nissan Pathfinder, Frontier & Xterra 2010 - 1997

UNIT PACKAGE: 25



22056

(Toyota: 75867-30130)
White Nylon

Rocker Moulding Retainer with Sealer
Lexus CT 200h, ES 300h, ES 350, GS 300, GS 350, GS 430, GS 460, GS 450h, HS 250h, IS 250, IS 350, IS F, LS 460, LS 600h & LX 570 and Toyota Land Cruiser 2006 - On

UNIT PACKAGE: 25



21226

(75867-02010)
Black Nylon

Overall Length: 15.5mm
Corolla 2009 - On

UNIT PACKAGE: 25

TRIMMING SUNDRIES & FASTENERS

Refer to Retainer Specification Chart on pages 510-523

Sec. 19



22478

(Toyota: 75867-52020)
Blue Nylon

Rocker Panel Retainer

Top Head Diameter: 13mm
Bottom Head Diameter: 18mm
Stem Diameter: 9.5mm
Stem Length: 13mm
Overall Length: 19mm
Toyota Prius, Prius C, Prius Prime
& Yaris 2012 - On

UNIT PACKAGE: 25



22432

(Chrysler: 68093998-AA; Fiat: 71728806;
Citroen & Peugeot: 856543)
White Nylon

Body Side Moulding Clip with Sealer

Top Head Size: 11mm x 12mm
Bottom Head Size: 15mm x 19mm
(Including the Sealer)
Stem Diameter: 10.3mm
Stem Length: 13mm
Fiat, Citroen, Peugeot,
Chrysler Postal Minivan Vehicles &
Dodge Ram Promaster 2014 - On

UNIT PACKAGE: 25



22716

(VW: 4F0-831-719)
Light Gray Nylon

**Door Weatherstrip
Retainer with Sealer**

Top Head Diameter: 13mm
Middle Head Diameter: 13mm
Bottom Head Diameter: 10mm
Stem Diameter: 8mm
Stem Length: 9mm
Fits into 6mm Hole
Audi A6 & S6 2011 - 2005

UNIT PACKAGE: 25



22571

(Toyota: 75867-68010)
White Nylon

**Rocker Panel & Wheel Opening
Moulding Retainer**

Top Head Diameter: 13mm
Bottom Head Diameter: 18mm
Stem Length: 14.5mm
Stem Diameter: 9.5mm
Toyota C-HR, Camry, Prius, Prius C,
Prius Prime, Prius V & RAV4 2012 - On

UNIT PACKAGE: 50



20932

(G18K-51-SJ3)
White Nylon

**Door Trim Panel
Retainer with Sealer**
Mazda 3, 5, 6, CX-7,
Miata & Protege 2001 - On

UNIT PACKAGE: 10



21678

(Mazda: NE51-51-SJ3A)
Black Nylon

**Moulding Retainer
With Sealer**
CX-9 & Miata 2006 - On

UNIT PACKAGE: 10



18875

(67771-16170)
White Nylon

Door Trim Panel Retainer
Toyota Tercel 1991 - On

UNIT PACKAGE: 25



20473

(67771-12070)
White Nylon

**Door Panel & Rocker Moulding
Retainer with Sealer**
Lexus SC300/400 and
Toyota Avalon &
Corolla 1992 - On

UNIT PACKAGE: 15



22361

(Mitsubishi: MR489986)
Pale Yellow Nylon

Wheel Arch Cover Retainer with Sealer

Top Head Diameter: 12mm
Bottom Head Diameter: 16mm
Stem Diameter: 8mm
Stem Length: 8mm
Mitsubishi Montero 2001 - On
Outlander 2015 - On

UNIT PACKAGE: 15



22513

(Mitsubishi: MU000573)
White Nylon

**Interior Speaker Grille &
Rocker Moulding Retainer**
Top Head Diameter: 12mm
Bottom Head Diameter: 16mm
Stem Diameter: 8mm
Stem Length: 10mm
Mitsubishi Galant 2012 - On
Lancer 2016 - 2008

UNIT PACKAGE: 25



TRIMMING SUNDRIES & FASTENERS

Refer to Retainer Specification Chart on pages 510-523



21690
(Mitsubishi: MR322000)
White Nylon
Trim Panel Retainer with Sealer
Diamante, Eclipse, Galant, Montero &
Outlander 2000 - On

UNIT PACKAGE: 25



19334
(MB566720)
Natural Nylon
**Rear Pillar Trim &
Air Inlet Grille Retainer**
Mitsubishi Eclipse 1994 - On

UNIT PACKAGE: 15



22251
(Landrover: LR013135; Ford: W714231-S300)
White Nylon
**Trim Panel, Tail Gate & Luggage
Compartment, Door, Pillar, Side Moulding,
Sill Plate Retainer with Sealer**
Land Rover LR3, Range Rover Sport
& Range Rover Sport Supercharge 2009 - 2005;
Ford Transit Connect 2014 - On; 150, 250, 350 2015 - On

UNIT PACKAGE: 15



21489
(11610606)
Yellow Nylon
Door Trim Panel Retainer
Chevrolet Cruze 2011 - On

UNIT PACKAGE: 25



21364
(13252119)
Green Nylon
Door Panel Retainer
Buick, Cadillac, Chevrolet
& GMC 2010 - On

UNIT PACKAGE: 25



22278
(GM: 11546963; 11547601)
Gray Nylon
Door Panel Retainer
Cadillac Escalade, Chevrolet Silverado,
Suburban & Tahoe and GMC Sierra &
Yukon 2015 - On

UNIT PACKAGE: 25



22279
(GM: 11546964; 11547602)
Yellow Nylon
Door Panel Retainer
Cadillac Escalade, Chevrolet Suburban,
Tahoe and GMC Yukon 2015 - On

UNIT PACKAGE: 25



21819
Yellow Nylon
Retainer
VW, Audi, SEAT, Skoda & Ford

UNIT PACKAGE: 25



22905
(Mercedes: 000-997-01-33)
Black Nylon
**Cowl & Liftgate Moulding Trim
Retainer with Sealer**
Top Head Dia.: 13mm
Bottom Head Dia.: 16mm
Stem Diameter: 9.3mm
Stem Length: 14mm
Mercedes-Benz B 250e, C 300, C 350e,
C 400, AMG C 43, AMG 450, AMG C 63, E 300,
AMG 63, GL 350, GL 450, GL 550, AMG GL 63,
GLA 250, AMG GLA 45, GLE 300d, GLE 350,
GLE 400, AMG GLE 43, GLE 550e, AMG GLE 63,
ML 250, ML 350, ML 400, ML 550, AMG ML 63,
S 550, S 560 & AMG S 65 2012 - On

UNIT PACKAGE: 25

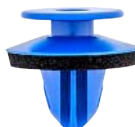

22417
(Audi: 8U0-853-909)
Blue Nylon
**Wheel Arch Opening
Moulding Retainer with Sealer**
Top Head Diameter: 13.3mm
Bottom Head Diameter: 17mm
Stem Diameter: 9.3mm
Stem Length: 10mm
Audi RS & Q3 and Volkswagen Golf,
R32, GTI & Rabbit, 2015 - On

UNIT PACKAGE: 25



21853
(VW: 7M0-867-299-K, 7M3-867-299;
Land Rover: DYC500020;
Ford: 1008068)
Yellow Nylon
**Door Trim Panel
Retainer with Sealer**
Land Rover 1997 - On
VW & Audi 1999 - On

UNIT PACKAGE: 25

TRIMMING SUNDRIES & FASTENERS

Refer to Retainer Specification Chart on pages 510-523

Sec. 19



21787
(BMW: 51-77-7-171-002)
White Nylon

Wheel Arch Cover & Footboard Retainer with Sealer
BMW X Series 2006 - On
Mini-Cooper S & SX Series 2011 - On

UNIT PACKAGE: 25



21412
(TD12-51-SJ3A)
Gray Nylon

Rocker Moulding Retainer with Sealer
Mazda 6 GT 2010 - On

UNIT PACKAGE: 15



25283
(Ford: W790486-S900)
White Nylon

Windshield Pillar Trim Retainer with Sealer
Top Head Diameter: 10mm
Bottom Head Diameter: 17mm
Stem Diameter: 7.3mm
Stem Length: 9mm
Overall Height: 14.3mm
Ford Bronco 2021 - On; Lincoln Corsair 2020 - On

UNIT PACKAGE: 25



22520
(Mazda: KD53-51-SJ3A)
Gray Nylon

Stone Guard Moulding Clip with Sealer
Top Head Size: 10mm x 15mm
Bottom Head Diameter: 18mm
Stem Diameter: 12mm
Stem Length: 9mm
Mazda CX-5 2016 - On

UNIT PACKAGE: 25



22512
(Mazda: KD53-51-W24)
Gray Nylon

Wheel Arch Moulding Retainer
Top Head Diameter: 14mm
Bottom Head Diameter: 18.5mm
Stem Diameter: 11mm
Stem Length: 14mm
Mazda CX-3, CX-5 & CX-9 2013 - On

UNIT PACKAGE: 25



22510
(Mazda: KD51-51-W24)
White Nylon

Wheel Opening Moulding Retainer with Sealer
Top Head Diameter: 15mm
Bottom Head Diameter: 18.5mm
Stem Diameter: 10.8mm
Stem Length: 14mm
Mazda CX-5 2014 - 2013

UNIT PACKAGE: 15



22899
(Mercedes: 000-991-24-98)
White Nylon

Upper Quarter Trim Retainer
Top Head Diameter: 13mm
Bottom Head Diameter: 19mm
Stem Diameter: 11.5mm
Stem Length: 19mm
Mercedes-Benz E 250, E 350, E 400 & E 550 2016 - 2010
AMG® E 63 2015 - 2010

UNIT PACKAGE: 25



22839
(GM: 11549307)
Natural Nylon

Door Trim Panel Retainer with Sealer
Top Head Diameter: 15mm
Bottom Head Diameter: 18mm
Stem Diameter: 8.75mm
Stem Length: 17mm
Chevrolet Silverado 2019 - On

UNIT PACKAGE: 15



25263
(Audi: 4M0-805-163)
White & Green Nylon

Bumper Cover Retainer
Top Head Diameter: 13mm
Middle Head Diameter: 18mm
Bottom Head Diameter: 14mm
Stem Diameter: 8mm
Stem Length: 19mm
Overall Height: 25mm
Audi Q7 2020 - 2017, Q8 2020 - 2018, SQ7, SQ8 2020

UNIT PACKAGE: 25



22767
(Nissan: 80897-7J100)
Yellow Nylon

Door Insulator Clip
Head Size: 17mm x 20mm
Stem Diameter: 7mm
Stem Length: 19mm
Overall Length: 22mm
Fits into 6mm Hole
Nissan Cube, Juke, Leaf, Murano, NV, Rogue, Rogue Sport, Sentra, Titan, Versa & Versa Note 2007 - On

UNIT PACKAGE: 25

TRIMMING SUNDRIES & FASTENERS

Refer to Retainer Specification Chart on pages 510-523



22244
(Land Rover: LR034389; LR053837)
White Nylon

Pillar Retainer with Sealer
Land Rover Discovery &
Range Rover Sport 2010 - On

UNIT PACKAGE: 15



22093
(Land Rover: DKP5279L)
Black Nylon

Trim Panel Retainer
Land Rover Discovery &
Defender 2004 - 1989

UNIT PACKAGE: 25



21795
(Toyota: 67773-0E020)
White Nylon

Door Panel Retainer with Sealer
Overall Length: 20mm
Lexus RX350 2009 and
Toyota Camry 2012 - On

UNIT PACKAGE: 25



19810
(N807943-S)
Black Nylon

Trim Panel Retainer
Ford Mustang 1995 - On

UNIT PACKAGE: 50



22821
(Honda: 91512-TZ5-A01)
White Nylon

Rocker Moulding Retainer
Top Head Size: 18mm x 18mm
Bottom Head Size: 20mm x 22mm
Stem Diameter: 9.8mm
Stem Length: 22.5mm
Acura MDX & NSX 2014 - On
Honda Odyssey, Pilot
& Ridgeline 2016 - On

UNIT PACKAGE: 15



19213
(6503709)
Natural Nylon

Trim Panel Retainer
Dodge Ram 1994 - On

UNIT PACKAGE: 50



12565
(N801925-S)
Black Nylon

Door Trim Panel Retainer
Ford 1981 - On

UNIT PACKAGE: 25



20829
(6505534-AA)
Black Nylon

Door Trim Panel Retainer
Chrysler Concorde, Intrepid,
LHS & 300M 1998 - On

UNIT PACKAGE: 50



17124
(N805155-S)
Black Nylon

Trim Panel Retainer
Ford 1985 - On

UNIT PACKAGE: 50



25260
(VW: 3B0-867-333)
White Nylon

Trim Panel Retainer
Top Head Diameter: 12.5mm
Bottom Head Diameter: 15mm
Stem Diameter: 5.8mm
Stem Length: 15mm
Volkswagen GTI, Rabbit 2009 - 2006,
Jetta 2014- 2001, Passat 1998 - On,
Touareg 2010 - 2004

UNIT PACKAGE: 25



22259
(GM: 11547047)
Black Nylon

Headliner Retainer
Cadillac CT6 & ELR and
Chevrolet Impala 2015 - On

UNIT PACKAGE: 25



13470
(N802900)
White Nylon

Door Trim Panel Retainer
Ford

UNIT PACKAGE: 25

TRIMMING SUNDRIES & FASTENERS

Refer to Retainer Specification Chart on pages 510-523

Sec. 19



18848

(F58Z-16237A02-A)
Yellow Nylon

Door Trim Panel Retainer
Ford Windstar 1995 - On

UNIT PACKAGE: 25



17218

(21042045, 21042053,
21042058, 21042104)
Natural Nylon

Door Trim Panel Retainer
GM Saturn 1991 - On

UNIT PACKAGE: 50



23783

(01553-S3500)
White Nylon

Door Trim Panel Retainer
Top Head Diameter: 13mm
Bottom Head Diameter: 19mm
Stem Diameter: 8.8mm
Stem Length: 17mm
Nissan Trucks

UNIT PACKAGE: 50



21091

(22691056)
Black Nylon

**Tailgate Moulding
Retainer with Sealer**
Cadillac Escalade EXT
and Chevrolet Avalanche 2007 - On

UNIT PACKAGE: 15



20274

(Not Supplied by O.E.M.)
White Nylon

Door Panel Retainer
Use with Auveco 20275
Chrysler LH Series 2000 - On

UNIT PACKAGE: 25



19802

(MB566719)
White Nylon

Door Moulding Retainer
Chrysler Concorde, Eagle Talon
& Sebring 1996 - On

UNIT PACKAGE: 15



17102

(GM: 10143422; Ford: N805612-S100;
AMC: 8934-202-599)
Natural Nylon

Trim Panel Retainer
Ford Tempo & Topaz, Jeep Eagle
& Premier and Pontiac 1988 - On

UNIT PACKAGE: 50



20944

(11588863)
Green Nylon

Door Trim Panel Retainer
Buick Terraza, Chevrolet
Uplander, Pontiac Montana
& Saturn Relay 2005 - On

UNIT PACKAGE: 25



18175

(10158124)
Natural Nylon

Trim Panel Retainer
GM, Chrysler 1992 - On

UNIT PACKAGE: 50



21346

(10350983)
White Nylon

Trim Panel Retainer with Sealer
Mates with Auveco 21347
Cadillac, Chevrolet
& Pontiac 2004 - On

UNIT PACKAGE: 15



21532

(Not Available from O.E.M.)
White Nylon

Front Bumper Cover Retainer
GM Trucks 2008 - On

UNIT PACKAGE: 25



11671

(387182-S)
Black Nylon

Seat Back Panel Retainer
Ford 1977 - On

UNIT PACKAGE: 25

TRIMMING SUNDRIES & FASTENERS

Refer to Retainer Specification Chart on pages 510-523



18391
(15694099)
Natural Nylon

Rear Door Trim Panel Retainer
Chevrolet Astro &
GMC Safari Mini Vans 1993 - On

UNIT PACKAGE: 15



20634
(GM: 10363811; 22722859)
White Nylon

Door Panel Retainer
Use with Auveco 20635
Oldsmobile Alero &
Pontiac Grand Am 2002 - On

UNIT PACKAGE: 25



23552
(22699649,
22704458, 22713392,
11562287, 10363811)
Nylon

Door Panel Retainer
Grommet Hole: 9mm
Grommet Flange Diameter: 24mm
Pin Top Head Diameter: 13mm
Pin Overall Length: 32mm
Pontiac Grand Am &
Oldsmobile Alero 2002 - On

UNIT PACKAGE: 25



21383
(11561499)
White Nylon

Trim Panel Retainer
Use with Auveco 21384
Chevrolet Traverse 2010 - On

UNIT PACKAGE: 25



20995
(11562043)
White Nylon

Door Panel Retainer with Sealer
Cadillac SRX & STS,
Chevrolet Cobalt & HHR and
Hummer H3 2004 - On

UNIT PACKAGE: 15



20996
(11562044)
Yellow Nylon

Door Panel Retainer with Sealer
Cadillac SRX & STS, Chevrolet
Cobalt & HHR and
Hummer H3 2004 - On

UNIT PACKAGE: 15



23553
(11562288)
Nylon

Door Panel Retainer
Grommet Hole: M9
Grommet Flange Diameter: 24mm
Pin Top Diameter: 19.5mm
Pin Overall Length: 30mm
Hummer H2 2006 - On

UNIT PACKAGE: 15



20998
(11562256)

Black Nylon Pin & White Nylon Grommet

Door Panel Retainer with Sealer
Chevrolet Cobalt, HHR
& Full-Size Van 2005 - On

UNIT PACKAGE: 15



20999
(11562257)

Green Nylon Pin & Yellow Nylon Grommet

Door Panel Retainer with Sealer
Chevrolet Cobalt &
HHR 2006 - On

UNIT PACKAGE: 15



21535
(11571118)
White Nylon

Door Panel Retainer & Grommet
Buick Enclave & Lucerne,
Cadillac DTS, Chevrolet
Traverse, GM "G" Vans,
GMC Acadia and
Hummer H2 2008 - On

UNIT PACKAGE: 15



21536
(11571119)
Yellow Nylon

Door Panel Retainer & Grommet
Buick Enclave & Lucerne,
Cadillac DTS, Chevrolet Cobalt,
Colorado, Traverse, GM "G" Vans,
GMC Acadia & Canyon and
Pontiac G5 & Pursuit 2008 - On

UNIT PACKAGE: 15

TRIMMING SUNDRIES & FASTENERS

Refer to Retainer Specification Chart on pages 510-523

Sec. 19



25155

(Chrysler: 6510747AA)
Black Pin & Yellow Grommet Nylon

Door Panel Retainer with Sealer

Top Head Diameter: 16mm
Middle Head Diameter: 18mm
Bottom Head Diameter: 22mm
Stem Diameter: 8.75mm
Stem Length: 18.5mm
Overall Height: 30mm

Chrysler 200 2017 - 2015; Pacifica 2017 - On;
Voyager 2020 - On; Dodge Dart 2016 - 2014;
Jeep Cherokee 2019 - On; Ram 1500 2019 - On

UNIT PACKAGE: 15



25156

(Chrysler: 6510359AA)
Black Pin & White Grommet Nylon

Door Panel Retainer with Sealer

Top Head Diameter: 16mm
Middle Head Diameter: 18mm
Bottom Head Diameter: 22mm
Stem Diameter: 8.75mm
Stem Length: 18.5mm
Overall Height: 30mm

Chrysler Pacifica 2017 - On;
Voyager 2020 - On; Dodge Dart 2013 - 2012; Viper 2016;
Jeep Gladiator 2020 - On; Wrangler 2018 - On;
Ram 1500 2019

UNIT PACKAGE: 15



19527

(10408480)
Yellow Nylon

Door Garnish Moulding & Pillar Trim Panel Retainer

Overall Length: 25/32"

Buick Century & Regal, Chevrolet Venture, Olds Intrigue & Silhouette, Pontiac Grand Prix and Trans Sport 1997 - On

UNIT PACKAGE: 25



19275

(10287971)
White Nylon

Door Trim Panel Retainer

Overall Length: 25/32"

Buick Century & Regal, Chevrolet Venture, Olds Silhouette and Pontiac Trans Sport 1997 - On

UNIT PACKAGE: 50



16938

(15638413, 15963179)
Black Nylon

Trim Panel Retainer

Overall Length: 29/32"

GM Trucks 1991 - On

UNIT PACKAGE: 50



11797

(387477-S)
White Nylon

Interior Trim Panel

Overall Length: 15/16"

Ford 1977 - On

UNIT PACKAGE: 50



23683

(388499-S)

Door Panel Retainer

Top Head Diameter: 13mm
Bottom Head Diameter: 19.5mm
Stem Diameter: 7.2mm
Stem Length: 17mm
Ford 1978

UNIT PACKAGE: 50



25248

(GM: 11603263)

Green & White Nylon

Door Trim Panel Retainer with Sealer

Top Head Diameter: 15mm
Bottom Head Diameter: 18mm
Stem Diameter: 8.75mm
Stem Length: 16.5mm
Overall Length: 23.6mm
Cadillac CT4, CT5 2020 - On

UNIT PACKAGE: 15



25247

(GM: 11603262)

White Nylon

Door Trim Panel Retainer with Sealer

Top Head Diameter: 15mm
Bottom Head Diameter: 18mm
Stem Diameter: 8.75mm
Stem Length: 16.5mm
Overall Length: 23.6mm
Cadillac CT5 2020 - On; Escalade 2021 - On;
Chevrolet Suburban, Tahoe &
GMC Yukon 2021 - On

UNIT PACKAGE: 15



19356

(15986673)
White Nylon

Front & Rear Door Trim Panel Retainer

Overall Length: 1-3/32"

GM Trucks S10 & S15 1996 - On

UNIT PACKAGE: 50



17075

(389144-S)
White Nylon

Trim Panel Retainer

Overall Length: 1-5/32"

Ford 1981 - On

UNIT PACKAGE: 50



19270

(10285935)
White Nylon

Trim Panel Retainer

Overall Length: 1-3/16"

Buick Century & Regal,
Chevrolet Venture, GM Truck
Express/Savana, Olds Silhouette & Pontiac
Trans Sport 1997 - On

UNIT PACKAGE: 50

TRIMMING SUNDRIES & FASTENERS

Refer to Retainer Specification Chart on pages 510-523



20814
(10305191)
White Nylon

Door Panel Retainer
Overall Length: 1-3/16"
Chevrolet Impala, Lumina
& Monte Carlo 2000 - On

UNIT PACKAGE: 50



16695
(10153057)
White Nylon

Door Trim Panel Retainer
Overall Length: 1-1/4"
GM 1982 - On

UNIT PACKAGE: 25



20338
(10421018)
White Nylon

Door Trim Panel Retainer
Overall Length: 1-9/16"
GM 1997 - On

UNIT PACKAGE: 25



22231
(VW: 1K6-837-200B)
Black Nylon

Door Panel Retainer
Overall Length: 13mm
VW Golf V, GTI, Jetta &
R32 2010 - 1999

UNIT PACKAGE: 25



21137
(07-13-0-702-516)
Black Nylon

**Rear Quarter Wheel Opening
Moulding Retaining Clip**
Overall Length: 14mm
Mini-Cooper 2002 - On

UNIT PACKAGE: 25



22008
(Hyundai: 85495-2E050)
Black Nylon

Headliner Retainer
Overall Length: 15.5mm
Hyundai & Kia

UNIT PACKAGE: 50

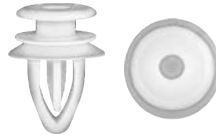

22336
(GM: 90560163)
White Nylon

Interior Trim Panel Retainer
Overall Length: 16mm
Saturn Astra, L100, L200, L300, LW2,
LW200, & LW300 2009 - 2000

UNIT PACKAGE: 25



18824
(G350-68-AB1)
White Nylon

Trim Panel Retainer
Overall Length: 16mm
Mazda 626, MX-6, Millenia, MX3, 929,
Protégé, MPV Ford Probe 1990 - On

UNIT PACKAGE: 50



21584
(693005370)
White Nylon

**Front Door & Lift Gate
Trim Panel Retainer**
Overall Length: 16mm
Subaru Impreza, Justy, Legacy &
Outback 2007 - 1987

UNIT PACKAGE: 25



21410
(90467-09212)
White Nylon

Cowl Trim Retainer
Overall Length: 16mm
Toyota Camry 2010 - On

UNIT PACKAGE: 25



22897
(Nissan: 01553-09131)
Blue Nylon

Quarter Trim Panel Retainer
Top Head Diameter: 13mm
Middle Head Diameter: 16mm
Bottom Head Diameter: 18mm
Stem Diameter: 9mm
Stem Length: 10mm
Infiniti G35, I30, I35 & M45 2007 - 2000
Q50 & Q60 2014 - On, Nissan 200SX &
Sentra 1999 - 1995, 350Z, Altima & Quest 2008 - 1999
GT-R, Maxima & Xterra 2005 - On

UNIT PACKAGE: 25

TRIMMING SUNDRIES & FASTENERS

Refer to Retainer Specification Chart on pages 510-523

Sec. 19



25249

(GM: 11603264)
Blue Nylon

Door Trim Panel Retainer with Sealer

Top Head Diameter: 13mm
Bottom Head Diameter: 18mm
Stem Diameter: 8.75mm
Stem Length: 16.5mm
Overall Length: 24.5mm
Cadillac CT4, CT5 2020 - On

UNIT PACKAGE: 15



21686

(Toyota: 67771-32120)
Green Nylon

Trim Panel Retainer with Sealer

Overall Length: 16.5mm
Lexus ES 300, GS 300, GS 450h,
IS F, IS 250, LS 460, LS 600h, RX 350, Scion
XA and Toyota Prius 2001 - On

UNIT PACKAGE: 25



22950

(Mercedes: 001-991-57-98)
Purple Nylon

Door Trim Panel Retainer with Sealer

Top Head Diameter: 13mm
Middle Head Diameter: 13mm
Bottom Head Diameter: 13mm
Stem Diameter: 9.4mm
Stem Length: 14mm
Overall Height: 20mm
Mercedes-Benz B 250 e 2017 - 2016;
B Electric Drive 2015

UNIT PACKAGE: 25



22048

(Subaru: 94078FA080)
White Nylon

Trim Panel Retainer

Overall Length: 16.5mm
Forester, Impreza &
XV Crosstrek 1994 - On

UNIT PACKAGE: 25



22152

(Land Rover: LR028939)
White Nylon

**Front Lower Fender &
Exterior Trim Retainer**

Overall Length: 16.5mm
Land Rover Evoque, HSE &
Range Rover 2014 - 2012

UNIT PACKAGE: 25



22910

(Chrysler: 68241251AA)
White Nylon

Body Side Moulding Clip

Top Head Size: 8mm x 10mm
Middle Head Size: 10mm x 14mm
Bottom Head Diameter: 20mm
Stem Diameter: 7mm x 12mm
Stem Length: 10mm
Fits into 9mm Hole
Jeep Renegade 2017 - 2015

UNIT PACKAGE: 10



22768

(Nissan: 84915-0W010)
White Nylon

**Wheelhouse, Trunk Trim
& Package Tray Retainer**

Top Head Diameter: 14mm
Middle Head Diameter: 16mm
Bottom Head Diameter: 18mm
Stem Diameter: 9mm
Stem Length: 10mm
Overall Length: 16.5mm
Infiniti QX4 2003 - 1997
Nissan Pathfinder 2004 - 1996
Sentra 2013 - On

UNIT PACKAGE: 25



20558

(62217-13010)
White Nylon

Garnish Moulding Retainer

Overall Length: 17mm
Lexus and Toyota Corolla,
Matrix & 4 Runner 2003 - On

UNIT PACKAGE: 25



22343

(Subaru: 909130096)
Green Nylon

**Cowl, Garnish, Headliner,
Rocker, Pillar & Interior Trim Retainer**

Overall Length: 17mm
Subaru B9 Tribeca, BRZ, Forester,
Impreza, Legacy, Outback, WRX & XV
Crosstrek 2005 - On

UNIT PACKAGE: 25



21188

(82315-27000)
Pink Nylon

Trim Panel Retainer

Overall Length: 17mm
Hyundai & Kia 2003 - On

UNIT PACKAGE: 15



22313

(Hyundai: 82315-2W000)
Green Nylon

**Door Panel, Interior Trim
& Garnish Retainer**

Overall Length: 17mm
Hyundai Santa Fe & Sonata 2013 - On
Kia Forte & K900 2014 - On

UNIT PACKAGE: 25



21149

(91560-S84-A01)
White Nylon

Trim Panel Retainer

Overall Length: 17.5mm
Honda Accord & Element 2003 - On

UNIT PACKAGE: 25

TRIMMING SUNDRIES & FASTENERS

Refer to Retainer Specification Chart on pages 510-523



20559

(GM: 88970345;
Toyota: 90467-10167)
Blue Nylon

Garnish Moulding Retainer

Overall Length: 17.5mm
Pontiac Vibe, Lexus and
Toyota 2000 - On

UNIT PACKAGE: 25



21240

(10369649)
Green Nylon

Door Panel Retainer with Sealer

Overall Length: 17.5mm
Pontiac Torrent 2006 - On

UNIT PACKAGE: 25



25316

(BMW: 07-14-7-460-560)
Gray Nylon

Lower Door Retainer

Top Head Diameter: 12.5mm
Middle Head Diameter: 15.5mm
Bottom Head Diameter: 18mm
Stem Size: 8mm x 10mm
Stem Length: 12.5mm
Overall Height: 17.5mm
Fits into 9mm Hole

BMW 228, M235 2021 - 2020, X3 2021 - 2018,
X4 2020 - 2019

UNIT PACKAGE: 25



25032

(Mercedes: 000-991-89-98)
Pink Nylon

Liftgate Trim Cover Retainer

Top Head Diameter: 13mm
Bottom Head Diameter: 17mm
Stem Diameter: 9mm
Stem Length: 14mm
Fits into 8mm Hole

Mercedes-Benz C300, C43
AMG 2017 - On; C63 AMG &
E400 2019 - 2017; E350 2016 - 2011; E450, E53
AMG 2019; E63 AMG 2018 - 2014

UNIT PACKAGE: 25



22948

(Mercedes: 001-991-41-98)
Green Nylon

Interior Trunk Trim Panel Retainer with Sealer

Top Head Diameter: 13mm
Middle Head Diameter: 13mm
Bottom Head Diameter: 17mm
Stem Diameter: 9.3mm
Stem Length: 8.5mm
Overall Height: 14mm

Mercedes-Benz C 300,
C 43 AMG & C 63 AMG 2017 - On
E 400 2018; E 450 & E53 AMG 2019

UNIT PACKAGE: 25



25215

(Mercedes: 000-991-86-98)
Orange Nylon

Door Trim Panel Retainer with Sealer

Top Head Diameter: 13.3mm
Middle Head Diameter: 13.3mm
Bottom Head Diameter: 17mm
Stem Diameter: 9.3mm
Stem Length: 13mm

Mercedes A220, GT53 AMG, GT63 AMG, Sprinter 1500,
2500, 3500 2019 - On, A35 AMG, CLA35 AMG, GLB250
2020 - On, B250e, S600 2017 - 2015, C250, ML350, ML63
AMG, SLK250 2015 - 2012, C300, GLA250, GLA45 AMG, S65
AMG 2020 - 2015; C350 2018 - 2012, C400, ML250,
ML400 2015, C43 AMG, GLC43 AMG, SL450, SLC300,
SLC43 AMG 2020 - 2017, C450 AMG, GLE450 AMG,
SLK300 2016, C63 AMG 2020 - 2012,
CLA250 2014 - On, CLA45 AMG 2014 - On, CLS450, CLS
53, AMG 2020 - 2019, E250 2016 - 2014, E300, GLE43 AMG,
GLS450, GLS550, GLS63 AMG 2019 - 2017, E350,
E63 AMG 2020 - 2010, E400, SL65 AMG 2018- 2013,
E43 AMG 2018 - 2017, E450, E53 AMG 2020 - 2019, E550,
GLK350 2017 - 2010, GL350, GL450, GL550,
GL63 AMG 2016 - 2013, GLC300, GLE400,
GLE63 AMG 2019 - 2016, GLC350e 2019 - 2018, GLC63
AMG, S450, S560 2020 - 2018, GLE300d 2017 - 2016,
GLE350, GLE550e 2018 - 2016, GLK250 2015 - 2013,
Metris 2020 - 2016, ML550 2014 - 2012, S550 2017 - 2014,
S63 AMG 2020 - 2014, SL400 2016 - 2015,
SL550 2020 - 2013, SL63 AMG 2019 - 2013,
SLK350, SLK55 AMG 2016 - 2012

UNIT PACKAGE: 25



22269

(Ford: W716507-S300)
White Nylon

**Front & Rear Door,
Body Side and Wheel Opening
Moulding Retainer with Sealer**

Overall Length: 17.5mm

Ford Transit Cargo & Passenger Van 2015 - On

UNIT PACKAGE: 15



22853

(BMW: 51-41-7-325-082)
Black & White Nylon

**Door Trim Panel Retainer
With Rubber Sealer**

Top Head Diameter: 15mm
Middle Head Diameter: 16mm
Bottom Head Diameter: 17.5mm
(Including Seal)

Stem Length: 10mm
Fits into 8mm Hole

BMW 530e, 530i, 540i, 640i, M5, M550i & X3 2017 - On

UNIT PACKAGE: 25

TRIMMING SUNDRIES & FASTENERS

Refer to Retainer Specification Chart on pages 510-523

Sec. 19



23700

(01553-00042)

Door Trim Retaining Panel
Top Head Diameter:13mm
Middle Head Diameter:16mm
Bottom Head Diameter:18mm
Stem Diameter: 8.5mm
Stem Length: 10mm
Nissan

UNIT PACKAGE: 50



19109

(67771-30070)
Natural Nylon

Door Trim Panel & Garnish Retainer
Overall Length: 18mm
Toyota Corolla Wagon, Tercel
T-100 & Tacoma 2WD 1992 - On
UNIT PACKAGE: 25



21574

(909130034)
White Nylon

Door, Pillar, Rocker, Floor & Interior Trim Retainer
Overall Length: 18mm
Subaru Baja, Forester, Legacy & Outback 2008 - 2003
UNIT PACKAGE: 25



21638

(91560-S0X-A01)
White Nylon

Trim Panel Retainer with Sealer
Overall Length: 18mm
Honda Accord, CR-V, Fit & Odyssey 1999 - On
UNIT PACKAGE: 15



21675

(91560-SZW-003)
Green Nylon

Door Panel & Interior Trim Retainer
Overall Length: 18mm
Honda Civic 2012 - On
UNIT PACKAGE: 25



19466

(91560-SZ3-003)
White Nylon

Door Trim Panel Retainer
Overall Length: 18mm
Acura 3.5RL 1996 - On
UNIT PACKAGE: 15



21070

(Hyundai: 82315-38000
GM: 94530565)
White Nylon

Trim Panel Retainer
Overall Length: 18mm
Chevrolet Aveo 2004 - On
Hyundai Accent, Santa Fe, Sonata
Tiburon & XG300/350 1999 - On
and Kia Optima, Rio & Sorento 2001 - On
UNIT PACKAGE: 25



22312

(Kia: 0K95-A-68401)
Gray Nylon

Exterior & Interior Moulding Retainer
Overall Length: 18mm
Kia Soul, Sedona & Sportage 2010 - On
UNIT PACKAGE: 50



22860

BMW: 07-14-7-443-710)
Gray Nylon

Rocker Moulding Retainer
With O-Ring Seal
Top Head Diameter: 12.5mm
Middle Head Diameter: 15.5mm
Bottom Head Diameter: 18mm
Stem Diameter: 9.5mm
Stem Length: 12.5mm
BMW X1, X3 & X4 2018 - 2015
UNIT PACKAGE: 25



22793

(BMW: 07-14-7-133-419)
Beige Nylon

Door Trim Panel Retainer
Top Head Diameter: 14mm
Middle Head Diameter: 15mm
Bottom Head Diameter: 18mm
Stem Diameter: 9mm
Stem Length: 12mm
BMW 128i, 135i, 135is, 328i, X3 & X4 2011 - On
UNIT PACKAGE: 25



20983

(GJ6R-68-ABX)
White Nylon

Trim Panel Retainer with Sealer
Overall Length: 18mm
Mazda 3, 5, 6, Miata & RX-8 2003 - On
UNIT PACKAGE: 15



22305

(Mercedes: 001-991-26-98)
Yellow Nylon

Door Trim Panel Retainer with Sealer
Overall Length: 18mm
Mercedes-Benz CLS400, CLS550, CLS63,
S500, S600 & S63 2012 - On
UNIT PACKAGE: 15



22309

(Mercedes: 000-991-01-98; 011-988-76-78)
White Nylon

Door Upper Pillar Trim & Trunk Lining Retainer with Sealer
Overall Length: 18mm
Mercedes-Benz C250, C300, C350, C63, GLA250,
GLA45, GLK250 & GLK350 2013 - On
UNIT PACKAGE: 15



21208

(91560-SLJ-J01)
Gray Nylon

Door Trim Panel Retainer
Overall Length: 18mm
Acura RDX and Honda
Civic, CR-V & Pilot 2009 - On
UNIT PACKAGE: 10

TRIMMING SUNDRIES & FASTENERS

Refer to Retainer Specification Chart on pages 510-523



19731
(84915-0W000)
White Nylon

Trim Panel Retainer
Overall Length: 18.5mm
Nissan Pathfinder 1995 - On

UNIT PACKAGE: 15



19203
(67771-89104)
Natural Nylon

**Quarter Board
Inside Trim Panel Retainer**
Overall Length: 18.5mm
Toyota Truck 2WD 1997 - 1991

UNIT PACKAGE: 15



20411
(91560-S84-A11)
Black Nylon

Windshield Garnish Pillar Retainer
Overall Length: 18.5mm
Acura 3.2CL, Honda Accord,
Insight & Odyssey 1998 - On

UNIT PACKAGE: 15



21554
(91560-S7A-003)
Black Nylon

**Trim Panel Retainer
With Sealer**
Overall Length: 18.5mm
Honda Crosstour, Fit &
Odyssey 2010 - 2005

UNIT PACKAGE: 25



19145
(91560-SP0-003)
Gray Nylon

**Front & Rear Door
Trim Panel Retainer**
Overall Length: 18.5mm
Acura Integra & Legend and Honda Accord,
Civic, Prelude, Odyssey & Del Sol 1991 - On

UNIT PACKAGE: 25



21978
(Peugeot & Citroen: 6992.J4)
White Nylon

Trim Panel Retainer
Overall Length: 18.5mm
Peugeot & Citroen

UNIT PACKAGE: 25



22005
(Hyundai: 82315-33020)
White Nylon

Trim Panel Retainer
Overall Length: 18.5mm
Hyundai & Kia 1995 - On

UNIT PACKAGE: 50



20959
(91560-S9A-A01)
Blue Nylon

Door Panel Retainer
Overall Length: 19mm
Acura TL & TSX and Honda Accord,
Civic, CRV & Odyssey 2002 - On

UNIT PACKAGE: 25



21676
(91560-SZW-J01)
Yellow Nylon

**Windshield Moulding
& Interior Trim Retainer**
Overall Length: 19mm
Honda Civic 2012 - On

UNIT PACKAGE: 25



21916
(Peugeot & Citroen: 8335.TE;
Renault & Dacia: 82-00-700-969)
Yellow Nylon

Trim Panel Retainer
Overall Length: 19mm
Peugeot, Citroen, Renault & Dacia

UNIT PACKAGE: 25



21895
(Peugeot & Citroen: 6991.ZI;
Renault & Dacia: 82-00-909-084)
Blue Nylon

Trim Panel Retainer
Overall Length: 19mm
Peugeot, Citroen, Renault & Dacia

UNIT PACKAGE: 25



21917
Yellow Nylon

Trim Panel Retainer with Sealer
Overall Length: 19mm
Renault & Dacia

UNIT PACKAGE: 15



22285
(Mini-Cooper: 07-14-6-962-771)
Red Nylon

**Rocker Moulding &
Pillar Retainer with Sealer**
Overall Length: 19mm
Mini-Cooper 2006 - On

UNIT PACKAGE: 15

TRIMMING SUNDRIES & FASTENERS

Refer to Retainer Specification Chart on pages 510-523

Sec. 19



22156

(Land Rover: IPN500050)
White Nylon

Windshield Glass Side Moulding Retainer with Sealer

Overall Length: 19mm
Land Rover HSE & Range Rover Sport 2012 - 2006

UNIT PACKAGE: 15



22003

(Hyundai: 82315-2P000)
White Nylon

Trim Panel Retainer

Overall Length: 19mm
Hyundai & Kia 1999 - On

UNIT PACKAGE: 50



25269

(Honda: 91560-TRT-J01)
Natural Nylon

Door Panel & Carpet Retainer with Sealer

Top Head Diameter: 13mm
Middle Head Diameter: 16mm
Bottom Head Diameter: 18mm
Stem Diameter: 9.5mm
Stem Length: 13mm
Overall Length: 19mm
Acura TLX 2021 - On; Honda CR-V 2019,
Clarity 2017 - On, Insight 2019 - On

UNIT PACKAGE: 25



21944

(Peugeot & Citroen: 8742.G2)
Green & White Nylon

Trim Panel Retainer

Overall Length: 19.3mm
Peugeot, Citroen, Renault & Dacia

UNIT PACKAGE: 10



21360

(85849-3B000)
White Nylon

Headliner & Trim Panel Retainer

Overall Length: 19.5mm
Hyundai 2001 - On

UNIT PACKAGE: 25



21414

(80999-VE000)
White Nylon

Trim Panel Retainer with Sealer

Overall Length: 19.5mm
Infiniti & Nissan 1993 - On

UNIT PACKAGE: 25



20575

(Toyota: 67771-12080;
GM: 88970656)
Yellow & White Nylon

Door Panel & Rocker Moulding Retainer

Overall Length: 19.5mm
Toyota & Lexus 1998 - On
Pontiac Vibe 2003 - On

UNIT PACKAGE: 15



21206

(Honda: 91560-S6A-003;
Ford: W718230-S300)
Orange Nylon

Rear Liftgate, Headliner Retainer

Overall Length: 19.5mm
Honda Fit 2009 - On; Ford Escape,
Explorer 2020 - On, Expedition 2018 - On,
Transit 150-350 2014 - On
Lincoln Aviator, Corsair 2020 - On,
Navigator 2018 - On

UNIT PACKAGE: 15



20879

(007-988-99-78, 007-988-34-78)
Green Nylon

Door Trim Panel Retainer

Overall Length: 19.5mm
Mercedes-Benz 1996 - On

UNIT PACKAGE: 10



22237

(Nissan: 01553-30001)
White Nylon

Trim Panel Retainer

Overall Length: 20mm
Nissan Altima, Cube, GT-R, Murano,
Pathfinder, Quest, Rogue, Sentra,
Versa & Versa Note 2007 - On

UNIT PACKAGE: 25



20668

(01553-09791)
White Nylon

Trim Panel Retainer

Overall Length: 20mm
Nissan & Infiniti 1999 - On

UNIT PACKAGE: 15



20437

(90467-09206)
White Nylon

Trim Panel Retainer with Sealer

Overall Length: 20mm
Toyota RAV 4 & Tundra 2000 - On

UNIT PACKAGE: 15

TRIMMING SUNDRIES & FASTENERS

Refer to Retainer Specification Chart on pages 510-523



21102
(90467-A0005)
White Nylon

Door Trim Panel Retainer with Sealer
Overall Length: 20mm
Lexus ES 350, GX 470, IS 250, IS 350,
IS F, LS 460 & LS 600HL and Toyota
Camry, FJ Cruiser, Highlander,
RAV4 & 4-Runner 2001 - On

UNIT PACKAGE: 15



18844
(67771-06010, 67771-32090)
White Nylon

Trim Panel Retainer
Overall Length: 20mm
Cowl Side & Garnish
Center Pillar Retainer
Toyota Camry 1991 - On

UNIT PACKAGE: 10



21654
(Not Available from O.E.M.)
White Nylon

Trim Panel Retainer
Overall Length: 20mm
Lincoln MTX 2012 - On

UNIT PACKAGE: 25



18950
(90467-10168)
Black & White Nylon

Garnish Retainer
Overall Length: 20mm
Toyota Avalon & Camry 1991 - On

UNIT PACKAGE: 5



21329
(68061648-AA)
Black Nylon

Tail Light Retainer
Overall Length: 20mm
Dodge Ram 2009 - On

UNIT PACKAGE: 15



14728
(67771-22020)
Natural & Yellow Nylon

Door Panel Retainer
Overall Length: 20mm
Toyota

UNIT PACKAGE: 25



25093
(BMW: 51-71-8-234-698)
Black & White Nylon

Cowl Grille Clip with Sealer
Top Head Diameter: 12mm
Middle Head Diameter: 14mm
Bottom Head Diameter: 12.5mm
Stem Diameter: 7.5mm x 9mm
Stem Length: 14.7mm
Overall Height: 20mm
BMW 323, 328 2000 - 1999, 325, 330, M3
2006 - 2001, X3 2017 - 2011,
X4 2018 - 2015

UNIT PACKAGE: 25



22009
(Hyundai: 85506-4A000)
White Nylon

**Trim Panel &
Window Garnish Retainer**
Overall Length: 20mm
Hyundai Tucson & Kia Sorento 2003 - On
UNIT PACKAGE: 50



21289
(84953-JA00A)
Yellow Nylon

Trim Panel Retainer
Overall Length: 20mm
Nissan Altima 2010 - On
UNIT PACKAGE: 25



22157
(Jaguar: C2D5807)
Yellow Nylon

Rocker Moulding Retainer
Overall Length: 20mm
Jaguar XJ & XJ-L 2011 - On
UNIT PACKAGE: 15



20633
(Toyota: 90467-10188, Tesla
1011813-00-A)
Turquoise Nylon

Trim Panel Retainer, Liftgate Trim
Overall Length: 20mm
Toyota Sienna 2004 - On; Tesla S 2012 - On; 3 2016 - On
UNIT PACKAGE: 25



22364
(Subaru: 94044TA040)
Gray Nylon

Door Panel Retainer
Top Head Diameter: 13mm
Middle Head Diameter: 16mm
Bottom Head Diameter: 18mm
Stem Diameter: 9mm
Stem Length: 13mm
Overall Length: 20mm
Subaru Impreza, Legacy,
Outback & STI 2016 - 2007
UNIT PACKAGE: 25

TRIMMING SUNDRIES & FASTENERS

Refer to Retainer Specification Chart on pages 510-523

Sec. 19



21822

(Peugeot & Citroen: 6822.LL;
Tesla: 1047307-00-A)
White Nylon

**Door Panel, Cowl, Interior Trim,
Headliner, Fender, Liftgate Retainer**

Overall Length: 20mm
Peugeot, Citroen & Toyota; Tesla 3 2017 - On;
S 2012 - On; X 2015 - On; Y 2020 - On

UNIT PACKAGE: 25



23989

(01553-10611)
Nylon

Door & Interior Trim Retainer

Top Head Diameter: 13mm
Bottom Head Diameter: 18mm
Stem Diameter: 9.4mm
Stem Length: 13mm
Overall Length: 20mm
Infiniti EX35, FX35/50, G37,
M37/56 2008 - On
Nissan 370Z & Juke 2009 - On

UNIT PACKAGE: 25



22484

(Mazda & Ford: E120-68-ABI;
Mitsubishi: MR975267)
Yellow Nylon

Pillar, Scuff Plate & Trim Panel Retainer



Top Head Diameter: 13mm
Middle Head Diameter: 16.5mm
Bottom Head Diameter: 18mm
Stem Diameter: 9.3mm
Stem Length: 13mm
Overall Length: 20mm
Mazda 2 & 3 2015 - 2013

Mitsubishi Montero 1999 - On
Ford Escape (European Version) 2006 - 2000

UNIT PACKAGE: 25



18876

(Toyota: 90467-10161;
GM: 94858299)
White Nylon

Trim Board Retainer

Overall Length: 20.5mm
Sienna, Solara & Tercel 1990 - On
Geo Prizm & Pontiac Vibe 1998 - On

UNIT PACKAGE: 25



22712

(Mazda: KD45-68-865)
Green Nylon

**Liftgate, Interior Trim
& Headliner Retainer**



Top Head Diameter: 13mm
Middle Head Diameter: 16mm
Bottom Head Diameter: 18mm
Stem Diameter: 11mm
Stem Length: 11mm
Fits into 8mm Hole

Mazda 3, CX-3, CX-5 & CX-9 2013 - On

UNIT PACKAGE: 25



22004

(Hyundai: 82315-22000)
White Nylon

Trim Panel Retainer

Overall Length: 20mm
Hyundai Accent 1999 - 95

UNIT PACKAGE: 50



14269

(Isuzu: 8942264920;
Mazda: 9927-40-825;
Toyota: 67771-01010, 67771-12010)
White Nylon

Door Panel Retainer

Overall Length: 20.5mm
Isuzu, Mazda & Toyota

UNIT PACKAGE: 25



21138

(51-43-7-001-491-2)
White Nylon

Headliner Retainer

Overall Length: 20.5mm
Mini-Cooper 2005 - On

UNIT PACKAGE: 25



15709

(67771-02030)
Natural Nylon

Door Trim Retainer

Overall Length: 20.5mm
Toyota Corolla 1990 - On

UNIT PACKAGE: 50



21502

(909130213)
White Nylon

Door Trim Panel Retainer with Sealer

Overall Length: 20.5mm
Subaru Legacy & Outback 2010 - On

UNIT PACKAGE: 10



21118

(MB374270, MB374271)
White Nylon

Trim Panel Retainer

Overall Length: 20.5mm
Chrysler Laser, Stealth,
Jeep Eagle & Talon and
Mitsubishi Eclipse &
Montero 1989 - On

UNIT PACKAGE: 15



TRIMMING SUNDRIES & FASTENERS

Refer to Retainer Specification Chart on pages 510-523



14270
(67771-22010)
Blue & Natural Nylon
Door Panel Retainer
Overall Length: 20.5mm
Toyota
UNIT PACKAGE: 25



14144
(GM: 95005064;
Toyota: 67771-01010)
Black Nylon
Trim Panel Retainer
Overall Length: 20.5mm
Toyota & GM
UNIT PACKAGE: 25



20669
(01553-07111)
Black Nylon
Trim Panel Retainer
Overall Length: 20.5mm
Nissan Altima and
Infiniti G35 & Q45 1997 - On
UNIT PACKAGE: 25



22764
(Nissan: 63848-AQ100)
Red Nylon
**Wheel Opening Moulding
& Lift-gate Trim Retainer**
Top Head Diameter: 13mm
Middle Head Diameter: 16mm
Bottom Head Diameter: 18mm
Stem Diameter: 9mm
Stem Length: 11.5mm
Nissan Murano 2013 - 2008
Nissan Rogue 2017 - 2014
UNIT PACKAGE: 20



15707
(67771-03030)
Gray Nylon
Door Trim Retainer
Overall Length: 20.5mm
Toyota Camry 1988 - On
UNIT PACKAGE: 50



19898
(67771-02030)
Yellow Nylon
Trim Panel Retainer
Overall Length: 20.5mm
Toyota Corolla 1990 - On
UNIT PACKAGE: 50



22267
(GM: 11546850)
White Nylon
**Front Fender &
Exterior Trim Moulding Retainer**
Overall Length: 20.5mm
GMC Sierra 2015 - On
UNIT PACKAGE: 50



19910
(90467-08179)
Yellow Nylon
Garnish Retainer
Overall Length: 20.5mm
Toyota Tundra 1999 - On
UNIT PACKAGE: 25



21087
(90602-SAA-003)
Orange Nylon
Cowl Vent & Radiator Support Retainer
Overall Length: 20.5mm
Honda Fit & CRV 2003 - On
UNIT PACKAGE: 15



19257
(GM: 30006620;
Toyota: 67771-12050;
Suzuki: 09409-08320)
Nylon
**Cowl Vent Screen &
Door Trim Panel Retainer**
Overall Length: 20.5mm
Chevrolet Geo, Metro & Tracker, Lexus and Toyota
Celica, Corolla & Previa 1989 - On
UNIT PACKAGE: 15



25194
(Chrysler: 68085677AA)
Yellow Nylon
Interior Trim Retainer
Top Head Diameter: 12.5mm
Middle Head Diameter: 16mm
Bottom Head Diameter: 15mm
Stem Size: 6.5mm x 9.5mm
Stem Length: 14mm
Overall Height: 20.5mm
Dodge Durango 2017 - 2011
Jeep Grand Cherokee 2011 - On
UNIT PACKAGE: 25



19108
(67771-16080)
Natural Nylon
**Door Trim Panel & Back Panel
Upper Garnish Retainer**
Overall Length: 21mm
Toyota Truck 1988 - On
UNIT PACKAGE: 10



20610
(Honda: 91560-SM4-003)
White Nylon
Door Trim Panel Retainer
Overall Length: 21mm
Honda Accord 1990 - On
UNIT PACKAGE: 25

TRIMMING SUNDRIES & FASTENERS

Refer to Retainer Specification Chart on pages 510-523

Sec. 19



19386

(6505292AA)
Natural Nylon

Door Trim Panel Retainer
Overall Length: 21mm
Chrysler Vans 1998 - On

UNIT PACKAGE: 25



20515

(6505918-AA)
Yellow & White Nylon

Trim Panel Retainer
Overall Length: 21mm
Chrysler Caravan,
Town & Country and Voyager
Mini-Vans 2001 - On

UNIT PACKAGE: 25



22315

(Hyundai: 85849-3L000)
Gray Nylon

Garnish & Interior Moulding Retainer
Overall Length: 21mm
Hyundai Azera, Sonata &
Tuscon 2006 - On
Kia Forte 2010 - On

UNIT PACKAGE: 50



18874

(67771-16120)
Gray Nylon

**Front & Rear Door
Trim Panel Retainer**
Overall Length: 21mm
Toyota Tercel 1994 - On

UNIT PACKAGE: 15



19016

(67771-12040)
Dark Gray Nylon

Door Trim Panel Retainer
Overall Length: 21mm
Toyota Cressida 1992 - 1988

UNIT PACKAGE: 15



22498

(Mercedes: 008-988-09-78)
Gray Nylon

Headliner Retainer
Top Head Diameter: 13.5mm
Middle Head Diameter: 13.5mm
Bottom Head Diameter: 20mm
Stem Diameter: 9.5mm
Stem Length: 13mm
Mercedes-Benz Metris &
Sprinter 2010 - On

UNIT PACKAGE: 15



22572

(Nissan: 01553-0162U)
White Nylon

**Liftgate, Pillar & Quarter Panel
Trim Retainer**

Top Head Diameter: 13mm
Middle Head Diameter: 16mm
Bottom Head Diameter: 18mm
Stem Diameter: 10mm
Stem Length: 14mm
Overall Length: 21mm
Nissan Frontier, Maxima, Murano,
Pathfinder & Xterra 2007 - On

UNIT PACKAGE: 25



21788

(BMW: 51-41-8-224-768,
51-41-0-407-984)
White Nylon

**Door Panel Lining &
Rear Window Retainer with Sealer**

Overall Length: 21mm
BMW X Series 2006 - On
Mini-Cooper 2002 - On

UNIT PACKAGE: 25



21873

(BMW: 51-43-7-001-491)
White Nylon

Trim Panel Retainer
Overall Length: 21mm
Renault, Dacia & BMW
UNIT PACKAGE: 25



22229

(BMW: 51418224781;
51410407983; 51430141025)
Gray Nylon

Door Trim Panel Retainer with Sealer

Overall length: 21mm
BMW 1, 3, 4, 5, 6, X & Z Series 1992 - On
UNIT PACKAGE: 25



21247

(Ford: W709995-S300,
W713651-S300)
Green Nylon

Lift Gate, Door Trim Panel Retainer

Overall Length: 21mm
Ford Flex 2009 - On, Escape 2012 - 2008,
Fiesta 2019 - 2014, Transit 150, 250, 350 2015 - On,
Mercury Mariner 2011 - 2008
UNIT PACKAGE: 25



22206

(Subaru: 909130105)
White Nylon

**Front & Rear Door, Headliner,
Interior Trim, Liftgate & Quarter Panel Retainer**

Overall Length: 21mm
Subaru BRZ, Forester, Impreza, Legacy, Outback,
B9 Tribeca, WRX & XV Crosstrek 2002 - On
UNIT PACKAGE: 50

TRIMMING SUNDRIES & FASTENERS

Refer to Retainer Specification Chart on pages 510-523



22006

(Hyundai: 82315-36000,
92552-36000)
White Nylon

Trim Panel Retainer with Sealer
Overall Length: 21mm
Hyundai Accent & Elantra 2000 - 1995

UNIT PACKAGE: 25



22845

(Toyota: 90467-09232)
Red Nylon

Trim Panel Retainer
Top Head Diameter: 13mm
Middle Head Diameter: 16mm
Bottom Head Diameter: 18mm
Stem Diameter: 9mm
Stem Length: 15mm
Lexus IS 250 & IS 350 2015 - 2010
LC 500, LC 500h, LS 500, LS 500h,
NX 200t, NX 300 & NX 300h &
Toyota Highlander & Tacoma 2014 - On

UNIT PACKAGE: 25



21059

(90602-S5A-003)
Blue Nylon

Cowl Vent Retainer
Overall Length: 21mm
Acura RSX and Honda Civic & CR-V
2001 - On

UNIT PACKAGE: 15



22545

(Honda: 91560-TL0-G21)
Tan Nylon

Garnish Retainer with Sealer
Top Head Diameter: 13mm
Middle Head Diameter: 16.5mm
Bottom Head Diameter: 18mm
Stem Diameter: 9mm
Stem Length: 9mm
Acura RDX, TSX, ILX, RLX & TLX
and Honda Accord, CR-V
& Odyssey 2007 - On

UNIT PACKAGE: 15



22544

(Honda: 91560-TG1-T01)
Green Nylon

Garnish Retainer with Sealer
Top Head Diameter: 13mm
Middle Head Diameter: 16.5mm
Bottom Head Diameter: 18mm
Stem Diameter: 9.3mm
Stem Length: 12mm
Honda Accord, Civic, CR-V, Fit, HR-V,
Odyssey & Pilot 2013 - On

UNIT PACKAGE: 15



21884

(Peugeot & Citroen: 6990.50)
White Nylon

Trim Panel Retainer
Overall Length: 21.3mm
Peugeot & Citroen

UNIT PACKAGE: 25



22469

(Honda: 90651-T3L-003)
Black Nylon

Rear Bumper Garnish Retainer
Top Head Diameter: 13mm
Middle Head Diameter: 16.5mm
Bottom Head Diameter: 18mm
Stem Diameter: 9.3mm
Stem Length: 14mm
Acura NSX & RDX 2016 - On
and Honda Accord & Civic 2017 - 2013

UNIT PACKAGE: 25



18915

(6504014)
White Nylon

Door Trim Panel Retainer
Overall Length: 21.5mm
Chrysler Caravan Cirrus, Neon, Ram Truck,
Stratus & Voyager 1995 - On

UNIT PACKAGE: 50



17669

(6502907, 6504452)
Yellow Nylon

Trim Panel Retainer
Overall Length: 21.5mm
Jeep Grand Cherokee
& Dodge Truck 1993 - On

UNIT PACKAGE: 50



22220

(GM: 92138811)
White Nylon

**Front & Rear Door Sill and
Rocker Panel Moulding Retainer**
Overall Length: 21.6mm
Chevrolet Caprice & SS 2011 - On
Pontiac G8 2009 - 2008

UNIT PACKAGE: 25



19210

(67771-04040)
Natural Nylon

**Front Door Trim
Panel Retainer**
Overall Length: 22mm
Toyota Tacoma 1995 - On

UNIT PACKAGE: 50

TRIMMING SUNDRIES & FASTENERS

Refer to Retainer Specification Chart on pages 510-523



18294

(91566-SPO-003)
White Nylon

Trim Panel Retainer

Overall Length: 22mm
Honda 1990 - On
UNIT PACKAGE: 15



19628

(5012874-AA, 6505539-AA)
White Nylon

Door Trim Panel Retainer

Overall Length: 22mm
Jeep Grand Cherokee 1999 - On
UNIT PACKAGE: 25



21333

(11561654)
Blue Nylon

**Cowl, Pillar, Trim Panel
& Windshield Retainer**

Overall Length: 22mm
GM 2006 - On
UNIT PACKAGE: 15



22288

(Infiniti: 01553-10641)
Green Nylon

**Door & Interior Trim
Panel Retainer**

Overall Length: 22mm
Infiniti FX35, FX 37, FX50 & QX70 2009 - On
UNIT PACKAGE: 25



22499

(Honda: 91560-TX4-A01)
Yellow Nylon

Garnish Retainer with Sealer

Top Head Diameter: 13mm
Middle Head Diameter: 16.3mm
Bottom Head Diameter: 18mm
Stem Diameter: 9.5mm
Stem Length: 13mm

Acura ILX, MDX, RDX, RLX & TLX and Honda Civic, Clarity, CR-V, Fit, HR-V, Odyssey, Pilot & Ridgeline 2013 - On

UNIT PACKAGE: 25



25272

(GM: 11569810)
White Nylon

Trunk & Liftgate Trim Retainer with Sealer

Top Head Diameter: 13mm
Middle Head Diameter: 16.5mm
Bottom Head Diameter: 18mm
Stem Size: 7.5mm x 10mm
Stem Length: 15mm
Overall Length: 22mm

Buick Encore 2013 - On; Cadillac CT6 2017 - 2016,
CTS 2014 - 2010, SRX 2016 - 2010;
Chevrolet Cruze 2016 - 2011,
Equinox 2017 - 2012, Malibu 2010 - 2008,
Tahoe 2013 - 2008, Trax 2015 - On,
Volt 2019 - 2016; GMC Yukon 2013 -2008

UNIT PACKAGE: 25



22832

(Nissan: 01553-10481)
White Nylon

Interior Liftgate Trim Retainer

Top Head Diameter: 13mm
Middle Head Diameter: 16mm
Bottom Head Diameter: 18mm
Stem Diameter: 9.5mm
Stem Length: 16mm
Overall Length: 22mm
Infiniti EX35, EX37, FX35, FX37,
FX50, QX50 & QX70 and
Nissan Murano 2017 - 2009
Xterra 2011 - 2000

UNIT PACKAGE: 25



18862

(6503204)
Green Nylon

Trim Panel Retainer

Overall Length: 23mm
Chrysler Cirrus & Stratus 1995 - On

UNIT PACKAGE: 50



21250

(Not Available from O.E.M.)
Black Nylon

Seat Back & Trim Panel Retainer

Overall Length: 23mm
Jeep Commander 2006 - On

UNIT PACKAGE: 25



20765

(Jeep: 6507055-AA, 6507686-AA,
Tesla: 1016078-00-A)
Yellow Nylon

Door Panel Retainer, Trunk Trim

Overall Length: 23mm
Jeep Grand Cherokee 2003 - On
Tesla S 2012 - On

UNIT PACKAGE: 50



22149

(Land Rover: LR027255)
Blue Nylon

Wheel Arch Moulding Retainer

Overall Length: 23mm
Land Rover Evoque 2012 - 2004

UNIT PACKAGE: 15



19129

(GM: 95008221;
Toyota: 67771-30090;
Chrysler & Mitsubishi:
MB608104)
Yellow Nylon

**Door Trim Panel &
Back Panel Lower Garnish Retainer**

Overall Length: 23.5mm
Toyota Land Cruiser & 2WD Truck 1991 - On
Geo Prism 1997 - 1993

UNIT PACKAGE: 15

TRIMMING SUNDRIES & FASTENERS

Refer to Retainer Specification Chart on pages 510-523



23559
(67771-30090, 67771-28030)
Yellow Nylon
Door Trim Panel & Back Panel, Lower Garnish Retainer
Top Head Diameter: 13mm
Bottom Head Diameter: 18mm
Stem Diameter: 9.5mm
Stem Length: 17mm
Lexus LX 450 1996 - 1997
Toyota Land Cruiser 1991 - 1997

UNIT PACKAGE: 15



22031
(GM: 11569700)
Gray Nylon
Trim Panel Retainer
Overall Length: 24mm
Cadillac SRX; Chevrolet Equinox & Tahoe and GMC Denali & Yukon 2010 - On

UNIT PACKAGE: 15



20428
(5028438-AA)
Green & White Nylon
Door Trim Panel Retainer
Overall Length: 24.5mm
Chrysler Vans 2001 - On

UNIT PACKAGE: 25



20190
(W708621-S300)
Caramel & Natural Nylon
Trim Panel Retainer
Overall Length: 25mm
Ford Taurus & Sable 2000 - On

UNIT PACKAGE: 25



20949
(W711037-S300)
Black & Blue Nylon
Door Trim Panel Retainer
Overall Length: 25mm
Ford Edge, Escape, Freestyle Mariner, Montego & 500 2005 - On

UNIT PACKAGE: 25



21131
(90602-SEP-A00)
Black Nylon
Trim Panel Retainer
Overall Length: 25.5mm
Acura TL 2007 - On

UNIT PACKAGE: 15



20444
(15076791)
White Nylon
Trim Panel Retainer
Overall Length: 26mm
GM Trucks: Rendezvous, S & T 2002 - On

UNIT PACKAGE: 15



20616
(GM: 11519031;
Ford: W711521-S300)
White Nylon
Door Panel Retainer with Sealer
Overall Length: 26mm
Hummer H2 2003 - On
Lincoln 2007 - On

UNIT PACKAGE: 15



20427
(Chrysler: 6505759-AA, Ford: W714372-S300)
Gray & White Nylon
Door Trim, Liftgate Panel Retainer
Overall Length: 26mm
Chrysler Pacifica 2008 - 2004,
Town & Country 2001 - 2016, Voyager 2003 - 2001;
Dodge Caravan 2007 - 2001,
Grand Caravan 2020 - 2001;
RAM C/V Cargo Van 2015 & 2012;
Ford Expedition 2018 - On; Lincoln MKT 2019 - 2010

UNIT PACKAGE: 25



21379
(15931605)
Black Nylon
Cowl Grille Retainer with Sealer
Overall Length: 26mm
Chevrolet Traverse 2010 - On

UNIT PACKAGE: 10



25089
(Ford: W713727-S300)
Gray Nylon
Door Trim Panel Retainer with Sealer
Top Head Diameter: 14mm
Middle Head Diameter: 14mm
Bottom Head Diameter: 23mm
Stem Diameter: 10.6mm
Stem Length: 16mm
Ford Bronco 2021 - On; Escape 2020 - On;
Lincoln Nautilus 2019 - On; MKC 2019 - 2015

UNIT PACKAGE: 25



21169
(Ford: W713297-S300 ,
Tesla 1025401-00-A)
White Nylon
Door & Trunk Trim Panel Retainer with Sealer
Overall Length: 28mm
Ford EcoSport 2019 - On; Edge 2015 - On; Explorer 2011 - On; Fusion 2010 - On; Ranger 2019 - On;
Transit 2014 - On; Escape 2013 - On;
Expedition 2018 - 2019; F-150 2019 - 2015;
F-250, F-350 2019 - 2017; Focus 2018 - 2008;
Mustang 2018 - 2015; Taurus 2019 - 2010;
C-Max 2018 - 2013; Flex 2019 - 2009; Bronco 2021 - On
Lincoln Aviator 2020 - On; Nautilus 2019 - On;
Navigator 2019 - 2018; Continental 2018 - 2017;
MKC 2018 - 2015; MKX 2018 - 2016; MKZ 2017 - 2013
Tesla S 2012 - On

UNIT PACKAGE: 25

TRIMMING SUNDRIES & FASTENERS

Refer to Retainer Specification Chart on pages 510-523

Sec. 19



25091

(Ford: W721069-S300)
Yellow Nylon

Liftgate Trim Panel Retainer with Sealer

Top Head Diameter: 16mm
Bottom Head Diameter: 22mm
Stem Diameter: 11mm
Stem Length: 17mm
Ford Bronco 2021 - On

UNIT PACKAGE: 25



21189

(11519032)
Black Nylon

Trim Panel Retainer

Overall Length: 28mm
Buick Lucerne & Rainier, Cadillac DTS, Escalade & SPX, Chevrolet Avalanche, Malibu, Silverado, Tahoe & Trailblazer, GMC Envoy, Sierra, Suburban & Yukon, Hummer H2, H3 & H3T, Oldsmobile Bravada and Pontiac G6 2002 - On

UNIT PACKAGE: 10



18930

(22600612, 22651066)
Yellow Nylon

Trim Panel Retainer

Overall Length: 28mm
GM 1996 - On

UNIT PACKAGE: 25



22034

(GM: 11562568)
White Nylon

Windshield Garnish & Interior Trim Retainer

Overall Length: 29mm
Buick Enclave, Lucerne & Verano; Cadillac ATS, CTS, SRX & XTS; Chevrolet Cruze, Equinox & Traverse and GMC Acadia & Terrain 2008 - On

UNIT PACKAGE: 10



20563

(5023173-AA)
White Nylon

Door Trim Panel Retainer

Overall Length: 30mm
Jeep Liberty 2002 - On

UNIT PACKAGE: 15



22090

(BMW: 51477117532)
Brown Nylon

Scuff Plate Retainer

with Sealer Top
Overall Length: 30mm
Fits into 10mm Hole
BMW 1, 3, 5, 6 & X Series 2012 - 2002

UNIT PACKAGE: 15



22461

(Chrysler: 55116997AB, 55116997AA)
White Nylon

Door Trim Panel Retainer

Top Head Diameter: 16mm
Middle Head Diameter: 18mm
Bottom Head Diameter: 22mm
Stem Diameter: 12mm
Stem Length: 19mm
Dodge Ram 2011
Jeep Liberty 2006

UNIT PACKAGE: 25



17685

(6502991)
Yellow Nylon

Trim Panel & Tail Gate Retainer

Overall Length: 31.5mm
Jeep Cherokee 1993 - On

UNIT PACKAGE: 25



22885

(Chrysler: 68087885AA)
Turquoise Nylon

Lift Gate Retainer

Top Head Diameter: 13mm
Middle Head Diameter: 16mm
Bottom Head Diameter: 18mm
Stem Diameter: 8mm
Stem Length: 27.5mm
Overall Length: 31.5mm
Dodge Durango & Jeep Grand Cherokee 2011 - On

UNIT PACKAGE: 25



22012

(Hyundai: 87378-3N000)
Blue Nylon

License Plate Panel Retainer with Sealer

Overall Length: 44.5mm
Hyundai Equus 2011 - On

UNIT PACKAGE: 25



19775

(55350747AB)
White Nylon

Door Trim Panel Retainer with Sealer

Chrysler Mini-Vans 1999 - On

UNIT PACKAGE: 15

TRIMMING SUNDRIES & FASTENERS

Refer to Retainer Specification Chart on pages 510-523



19428
(22646099)
White Nylon

Trim Panel Retainer with Sealer
Chevrolet Cavalier &
Pontiac Sunfire 1995 - On

UNIT PACKAGE: 25



19804
(5023111AA)
White Nylon

Trim Panel Retainer with Sealer
Dodge Neon 2000 - On

UNIT PACKAGE: 15



22250
(Jaguar: C2C14628)
Black Nylon

Trim Panel Retainer With Sealer
Jaguar 2015 - On

UNIT PACKAGE: 15



20188
(003-988-41-78)
White Nylon

Trim Panel Retainer
Mercedes-Benz Body Styles
107, 108, 109, 114, 115,
123 & 124 1995 - 1968

UNIT PACKAGE: 10



21494
(VW: 171-807-249-A)
Natural Nylon

Trim Panel Retainer
VW Golf & Audi 1978 - On

UNIT PACKAGE: 25



20735
(463-988-02-78)
Black Nylon

Door Panel Retainer
Mercedes-Benz
G55 & G500
2002 - On

UNIT PACKAGE: 25



14363
(9927-40-821)
Natural Nylon

Door Panel Retainer
Mazda

UNIT PACKAGE: 25



13179
(BMW: 51-41-8-172-050;
VW: 481-867-197)
Black Nylon

Trim Panel Retainer
VW & BMW

UNIT PACKAGE: 50



22585
(BMW: 51-41-1-870-718)
Green Nylon

Door Panel Retainer
Top Head Diameter: 15mm
Bottom Head Diameter: 18mm
Stem Diameter: 9.5mm
Stem Length: 12mm
Fits into 8mm Hole
BMW 2002, 2002tii, 318i, 320, 320i, 323i,
325e, 325i, 325is, 325ix, 524td, 525i,
528e, 528i, 530i, 533i, 535i, 535is, 540i,
630csi, 633csi, 635csi, 733i, 735i, 735il,
740i, 740iL, 745i, 750iL, M3, M5
& M6 1993 - 1969

UNIT PACKAGE: 50



16778
(Mazda: 9927-40-822;
Toyota: 62581-14020)
Natural Nylon

Trim Panel Retainer
Mazda & Toyota

UNIT PACKAGE: 25



20252
(823-867-299)
Black Nylon

Trim Panel Retainer
VW Corrado, Eurovan, Jetta,
Rabbit & Vanagon 1979 - On

UNIT PACKAGE: 25



11349
(AMC: 4005099; GM: 796255;
Chry: 6033862)
Black Nylon

Door Panel Retainer
American Motors 1976 - On
GM 1988 - 1981
Jeep Wrangler 1991 - On

UNIT PACKAGE: 25



13475
(Renault: 8934-201-681;
VW: 175-867-299)
White Nylon

Trim Panel Retainer
AMC-Renault 1984 - On
VW 1982 - On

UNIT PACKAGE: 50

TRIMMING SUNDRIES & FASTENERS

Refer to Retainer Specification Chart on pages 510-523

Sec. 19



13945
(01553-S3500)
White Nylon

Door Trim Panel Retainer
Nissan Trucks

UNIT PACKAGE: 50



15461
(363137)
White Nylon

Trim Panel Retainer
Chevrolet Truck & GMC 1976 - On

UNIT PACKAGE: 50



11678
(Chry: 6003349; GM: 9685057;
AMC: 4005470; VW: N98905101)
White Nylon

Door Trim Panel Retainer
Chrysler, GM, AMC & VW 1976 - On

UNIT PACKAGE: 25



13453
(20480475)
White Nylon

Rear Quarter Panel Retainer
GM

UNIT PACKAGE: 50



13461
(20451401)
White Nylon

**Retains Conduit to
Sheet Metal in Doors**
GM

UNIT PACKAGE: 25



11672
(387496-S)
White Nylon

Trim Panel Retainer
Ford 1976 - On

UNIT PACKAGE: 25



15669
(10126901)
White Nylon

Trim Panel Retainer
GM 1987-On

UNIT PACKAGE: 50



20253
(BMW: 51-41-1-973-500,
Mercedes: 000-991-71-71)
White Nylon

Trim Panel Retainer
BMW Series 3, 5 & 7 1987 - On;
Mercedes Metris 2020 - 2016; Sprinter 1500,
2500, 3500 2010 - On

UNIT PACKAGE: 50



10621
(2064891, 9818648, 9883583)
White Nylon

**Door Trim Panel &
Headliner Retainer**
GM 1971 - On

UNIT PACKAGE: 50



11774
(9883583)
White Nylon

Door Trim Panel Retainer
GM 1971 - On

UNIT PACKAGE: 50



12737
(12337920, 20374473)
White Nylon

Door Panel Retainer
Camaro & Firebird 1982-On
GM Truck 1989-On

UNIT PACKAGE: 50



11796
(3065575)
White Nylon

Door Trim Panel Retainer
GM 1978-On

UNIT PACKAGE: 50



11677
(GM: 20298365; Chry: 6013122)
Natural Nylon

Trim Panel Retainer
Chrysler 1976-On
GM 1982-On

UNIT PACKAGE: 50

TRIMMING SUNDRIES & FASTENERS

Refer to Retainer Specification Chart on pages 510-523



17649
(15953247)
White Nylon

Trim Panel Retainer
GM C & K Trucks 1993-On

UNIT PACKAGE: 50



20279
(25672428)
White Nylon

Trim Panel Retainer with Sealer
Buick LeSabre & Park Ave., Cadillac DeVille & Seville, Oldsmobile Aurora & Pontiac Bonneville 1998 - On

UNIT PACKAGE: 10



15670
(15545202)
White Nylon

Door Trim Panel Retainer
GM Trucks 1988-On

UNIT PACKAGE: 50



12992
(10073833, 15600382, 20421800)
White Nylon

Door Trim Panel Retainer
GM 1983 - On

UNIT PACKAGE: 25



13946
(15588024, 15596301)
Yellow Nylon

Side & Rear Door Trim Retainer
GM Astro & Safari Mini-Vans 1985 - On

UNIT PACKAGE: 25



17092
(20734005)
Yellow Nylon

Door Trim Panel Retainer
GM 1982 - On

UNIT PACKAGE: 50



15970
(15607165, 15612948)
White Nylon

Trim Panel Retainer
GM Trucks 1976 - On

UNIT PACKAGE: 25



18936
(N811006-S)
Natural Nylon

Trim Panel Retainer
Ford 1995-On

UNIT PACKAGE: 25



20341
(3B0-868-243)
Black Nylon

Door Trim Panel Retainer
VW Beetle, Golf, Jetta & Passat 1998 - On

UNIT PACKAGE: 25



21398
(VW: 6K0-868-243-C)
Black Nylon

Trim Panel Retainer
Audi and Volkswagen Touareg 2004 - On

UNIT PACKAGE: 25



21144
(VW: 8E0-868-243)
Black Nylon

Interior Trim Panel Retainer with Sealer
Audi A4 & S4, Avant, Sedan Wagon, Cabriolet & Quattro 2005 - On

UNIT PACKAGE: 25



21708
(VW: 7L6-868-243)
Black Nylon

Door Trim Panel
Audi A5, A6, A7, S5, S6 & S7 And VW Beetle, Cabrio, Golf, Gti, Jetta, Passat & Touareg 2004 - On

UNIT PACKAGE: 15



25340
(VW: 3CN-868-243)
White & Black Nylon

Door Trim Panel Retainer with Sealer
Top Head Diameter: 21.5mm
Middle Head Diameter: 16mm
Bottom Head Diameter: 19.5mm
Stem Diameter: 7.5mm
Stem Length: 11mm
Overall Height: 23mm
Volkswagen GTI, Taos 2022; ID.4 2021-On

UNIT PACKAGE: 15

TRIMMING SUNDRIES & FASTENERS

Refer to Retainer Specification Chart on pages 510-523

Sec. 19



21415
(VW: 1H0-868-243-B)
Tan and White Nylon

**Adjustable Door
Trim Panel Retainer**
VW Golf 2002 - 1993

UNIT PACKAGE: 25



21997
(VW: 6N0-868-243A)
Black & White Nylon

Trim Panel Retainer
VW, Audi, SEAT & Skoda

UNIT PACKAGE: 10



21894
(VW: 5X0-867-299)
Black Nylon

Trim Panel Retainer
VW, Audi, SEAT & Skoda

UNIT PACKAGE: 15



22091
(BMW: 51717066299)
Black Nylon

Door Sill Cover Retainer
T27 Drive
BMW 5 & 6 Series 2011 - 2002

UNIT PACKAGE: 15



21854
(BMW: 07-14-7-122-913)
Black Nylon

**Rocker Trim
Wheelhouse Retainer**
T10 Torx® Drive
1, 3, 6 & X Series 2004 - On

UNIT PACKAGE: 15



22245
(Land Rover: LR012844)
Black Nylon

Body Liner Twist to Lock Retainer
Land Rover Discovery, Range Rover &
Range Rover Sport 2004 - On

UNIT PACKAGE: 15



22092
(BMW: 51717066226)
Black Nylon

**Rocker Moulding &
Door Sill Spacer Cover Retainer**
Overall Length: 27mm
BMW 5 & 6 Series 2011 - 2002

UNIT PACKAGE: 15



22086
(BMW: 07147122912)
Black Nylon

**Rocker Panel &
Wheelhouse Trim Retainer**
Overall Length: 32mm
BMW 1, 3, 6 & X Series 2012 - 2004

UNIT PACKAGE: 15



25343
(GM: 11571063)
Black Nylon

Tail Lamp Retainer with Sealer
Top Head Diameter: 16mm
Bottom Head Diameter: 17mm
Stem Diameter: 8.5mm Sq.
Stem Length: 9.5mm
Overall Height: 20mm
Fits into 9mm Hole

Buick Enclave 2020 - 2018, Encore 2013 - On;
Cadillac CTS 2015 - 2011; Chevrolet Trailblazer 2021 - On,
Trax 2015 - On, Volt 2019 - 2016; Pontiac Solstice 2009

UNIT PACKAGE: 25



19524
(N807875-S)
Green Nylon

Door Trim Panel Retainer
Lincoln Continental 1995 - On

UNIT PACKAGE: 25



20866
White Nylon

Double End Retainer
Marine & Automotive Trim Shops

UNIT PACKAGE: 25



17599
(15672328)
Black Nylon

Radiator Grille Retainer
GM S-10 & S-15 Pick-Ups 1991-On

UNIT PACKAGE: 25

RETAINER SPECIFICATION CHART

Recommended Hole Size: .030" - .060" smaller than stem diameter



Auveco Part No.	Type	Color	Bottom Head Diameter	Top Head Diameter	Stem Diameter	Stem Length	Page No.
3620	5	Black	13/32"		9/64"	7/16"	473
3639	5	White	3/8"		7/32"	7/16"	473
5592	5	Black	1/2"		9/32"	5/8"	474
8853	3	Natural	3/16" x 1/2"		3/16"	5/8"	469
10332	1	Black	1-1/4"		5/16"	1/2"	460
10621	12	White	3/4"	11/16"	5/16"	1/2"	506
10744	3	Black	3/16" x 1/2"		3/16"	7/16"	468
10831	1	Black	11/16"		5/16"	5/8"	457
10832	1	Gray	11/16"		5/16"	5/8"	457
11120	1	Black	13/32"		5/32"	3/8"	450
11129	1	Black	3/8"		7/32"	3/8"	449
11130	1	Black	2"		5/16"	3/4"	465
11136	2	Black	1/2" x 1-1/2"		9/32"	5/8"	473
11146	1	Black	11/16"		5/16"	13/16"	457
11347	1	Black	3/4"		9/32"	1/2"	453
11349	11	Black	3/4"	19/32"	5/16"	11/16"	505
11350	1	White	1-7/32"		5/16"	1-1/16"	464
11351	1	Black	15/16"		5/16"	11/16"	461
11612	1	Black	7/16"		3/16"	5/8"	451
11671	7	Black	5/8"	1/2"	11/32"	1-1/8"	488
11672	11	White	15/16"	29/32"	5/16"	15/16"	506
11673	1	Natural	15/16"		5/16"	11/16"	461
11675	1	Black	5/8"		5/16"	11/16"	453
11677	13	Natural	9/16"	3/8" x 9/16"	11/32"	11/16"	506
11678	11	White	15/16"	29/32"	5/16"	11/16"	506
11679	1	Black	3/4"		9/32"	1/2"	453
11680	1	Black	7/16"		3/16"	5/8"	451
11721	1	Black	1/2"		9/32"	3/4"	451
11774	12	White	3/4"	11/16"	5/16"	1/2"	506
11796	12	White	7/8"	29/32"	5/16"	3/4"	506
11797	10	White	3/4"	1/2"	11/32"	9/16"	490
11842	1	Black	1-1/4"		5/16"	1-3/16"	464
12137	1	Black	1"		7/16"	13/16"	462
12565	7	Black	25/32"	1/2"	5/16"	5/8"	487
12571	1	Black	1"		5/16"	13/16"	461
12731	1	Black	25/32"		5/16"	15/16"	461
12737	12	White	3/4"	21/32"	5/16"	3/4"	506
12759	1	Black	1"		9/32"	1-7/16"	462
12766	1	Black	7/8"		7/16"	13/16"	461
12909	1	Black	1"		9/32"	1-1/16"	463
12992	14	White	3/4" x 7/8"	9/32" x 19/32"	5/16"	3/4"	507
13179	11	Black	17mm	14mm	11mm	14mm	505
13453	11	White	15/16"	29/32"	5/16"	11/16"	506
13454	1	Black	21/32"		7/32"	15/32"	453
13461	11	White	15/16"	29/32"	5/16"	1-1/8"	506
13467	1	Black	1"		7/16"	1-7/16"	466
13470	7	White	3/4"	1/2"	5/16"	5/8"	487
13475	11	White	19mm	15mm	9mm	18mm	505
13757	Misc.	Black	2" Square		1/4"	9/16"	467
13945	11	White	19mm	15mm	9mm	18mm	506
13946	14	Yellow	3/4" x 7/8"	9/32" x 19/32"	5/16"	3/4"	507

RETAINER SPECIFICATION CHART

Recommended Hole Size: .030" - .060" smaller than stem diameter



Auveco Part No.	Type	Color	Bottom Head Diameter	Top Head Diameter	Stem Diameter	Stem Length	Page No.
14006	1	Black	3/8"		9/32"	1/2"	450
14017	1	Black	1/2"		9/32"	5/8"	452
14021	1	Black	7/16"		7/32"	1/2"	450
14032	1	Black	3/4"		5/16"	1-1/4"	456
14035	1	Natural	19/32"		5/16"	2"	456
14036	1	Black	3/4"		5/16"	1-3/8"	456
14144	10	Black	18mm	13mm	9.5mm	14mm	499
14163	2	Black	1-3/4"		3/8"	3/4"	465
14269	10	White	18mm	13mm	9.5mm	14mm	498
14270	10	Blue/Natural	18mm	13mm	9.5mm	14mm	499
14282	6	Black	13mm		7.5mm	15mm	475
14289	1	Black	13mm		5mm	16mm	451
14291	5	Black	11mm		5.5mm	13mm	474
14299	3	White	7mm x 16mm		6.5mm	5mm	467
14319	4	Black	20mm		18mm	20mm	479
14323	4	Black	18mm		10mm	15mm	478
14328	3	White	7mm x 16mm		6mm	10mm	468
14347	4	Black	18mm		9mm	12mm	478
14349	5	Black	11mm		7mm	15mm	474
14352	6	Black	13mm		6mm	13mm	475
14353	4	Black	14mm		10mm	16mm	478
14355	6	Black	11mm		6mm	13mm	474
14356	4	Black	20mm		11mm	16mm	479
14363	11	White	17mm	15mm	10mm	14mm	505
14367	1	Black	12mm		5mm	12mm	449
14709	1	Black	20mm		5.5mm	9mm	453
14720	4	Black	18mm		12.5mm	15mm	479
14723	4	Black	14mm		9mm	11mm	478
14728	10	Natural/Yellow	16mm	12.5mm	8.5mm	11mm	497
14736	5	Black	14mm		6mm	10mm	475
14737	6	Black	13mm		7mm	15mm	475
14738	6	Black	30mm		8mm	17mm	477
14757	1	Black	1/2"		1/4"	15/16"	454
14857	1	Black	1/2"		9/32"	5/8"	452
14921	1	Black	10mm		6mm	12mm	449
14985	3	White	3/16" x 9/16"		1/8" x 3/8"	5/16"	467
15040	1	Black	3/4"		7/32"	11/16"	455
15050	1	Black	15mm		5.5mm	19mm	453
15367	1	Black	19/32"		7/32"	3/4"	453
15414	1	Black	11/16"		5/16"	13/16"	457
15456	1	Black	1-21/32"		5/16"	3/4"	465
15457	1	Black	1-3/8"		5/16"	15/16"	465
15461	11	White	3/4"	5/8"	5/16"	1"	506
15478	1	Black	22mm		11mm	28mm	462
15479	1	Black	26mm		8mm	38mm	463
15480	1	Black	25mm		8mm	20mm	460
15481	1	Black	25mm		7.5mm	20mm	460
15523	1	Black	1"		1/4" x 5/16"	1-1/8"	460
15543	1	Black	7/8"		5/16"	1-3/32"	458
15664	1	White	11/16"		5/16"	5/8"	457

Sec. 19

RETAINER SPECIFICATION CHART

Recommended Hole Size: .030" - .060" smaller than stem diameter



Auveco Part No.	Type	Color	Bottom Head Diameter	Top Head Diameter	Stem Diameter	Stem Length	Page No.
15668	1	Black	1-3/4"		9/32"	1"	465
15669	11	White	15/16"	29/32"	5/16"	1-1/4"	506
15670	14	White	1/2"	1/4" x 29/64"	5/16"	3/4"	507
15707	10	Gray	17.5mm	13mm	10mm	14mm	499
15709	10	Natural	17.5mm	13mm	9.5mm	13mm	498
15970	14	White	9/16" x 11/16"	9/32" x 1/2"	5/16"	3/4"	507
15998	1	Black	30mm		6.5mm	9mm	464
16132	1	Black	19mm		9mm	20mm	458
16259	1	Black	11/16"		5/16"	5/8"	457
16260	12	White	3/4"	11/16"	5/16"	1/2"	506
16261	12	White	7/8"	29/32"	5/16"	3/4"	506
16262	1	Black	7/8"		7/16"	13/16"	461
16263	1	Black	1"		7/16"	13/16"	462
16695	9	White	20mm	18mm	8mm	23mm	491
16775	1	Black	20mm		4.5mm	15mm	458
16776	1	Black	18mm		7.5mm	20mm	454
16778	11	Natural	18.5mm	14mm	11.5mm	14mm	505
16779	4	Black	18mm		11mm	15mm	479
16818	1	Black	3/4"		11/32"	7/8"	455
16863	1	Black	1-3/4"		5/16"	29/32"	465
16938	9	Black	8mm	14mm	8mm	15mm	490
17004	2	Black	1-5/16"		3/8"	3/4"	466
17075	9	White	3/4"	33/64"	5/16"	13/16"	490
17076	1	Black	18mm		7mm	23mm	459
17092	14	Yellow	13/16" x 29/32"	5/8"	5/16"	3/4"	507
17102	7	White	3/4"	1/2"	5/16"	1"	488
17124	7	Black	3/4"	1/2"	11/32"	3/4"	487
17205	4	Black	14mm		8mm	15mm	478
17215	1	Black	40mm		8mm	13mm	465
17218	7	Natural	20mm	13mm	8mm	18mm	488
17237	Misc.	Black	29.5mm		7mm	9mm	466
17339	3	Black	5mm x 15mm		4mm	12mm	472
17381	1	Gray	32mm		8mm	20mm	464
17452	5	Black	13mm		5mm	15mm	475
17453	1	Gray	15mm		6.5mm	14mm	452
17599	Misc.	Black	3/4"		9/32" x 11/32"	11/16"	508
17612	1	Black	5/8"		3/8"	3/4"	458
17634	1	Black	12mm		6mm	16mm	450
17649	13	White	1/2" x 5/8"	9/32" x 1/2"	5/16"	7/8"	507
17664	1	Black	11/16"		5/16"	1-1/16"	457
17669	10	Yellow	23/32"	1/2"	5/16"	9/16"	501
17685	10	Yellow	18mm	13mm	8mm	25mm	504
17975	2	Black	1-3/16"		5/16"	1/2"	466
18033	3	White	1/4" x 21/32"		1/4"	15/32"	472
18114	4	Black	10mm		7.5mm	10mm	477
18157	6	Gray	13mm		5mm	16mm	475
18166	Misc.	Black	10mm		4mm	10mm	473
18174	1	Black	3/4"		5/16"	13/16"	455
18175	7	Natural	15/16"	1/2"	5/16"	15/16"	488
18248	2	Black	7/16"		11/64"	3/8"	473

RETAINER SPECIFICATION CHART

Recommended Hole Size: .030" - .060" smaller than stem diameter



Auveco Part No.	Type	Color	Bottom Head Diameter	Top Head Diameter	Stem Diameter	Stem Length	Page No.
18271	5	Black	14mm		6mm	15mm	475
18277	1	Gray	1"		5/16"	1-1/2"	463
18294	10	White	18mm	13mm	10.5mm	14mm	502
18297	6	Black	13mm		7.5mm	11mm	474
18298	1	Black	1/2"		5/16"	11/16"	450
18301	1	Black	3/4"		11/32"	1-3/16"	455
18302	1	Black	7/16"		7/32"	15/32"	450
18371	1	Gray	3/4"		5/16"	1-1/4"	456
18379	1	Black	23/32"		5/16"	7/8"	455
18389	1	Black	1/2"		9/32"	7/16"	450
18391	7	Natural	3/4"	1/2"	5/16"	1-5/32"	489
18458	4	Black	14mm		6mm	10mm	478
18508	3	Black	3/16" x 19/32"		15/32"	5/16"	473
18509	3	Natural	9/32" x 35/64"		9/32"	1/2"	468
18510	3	Natural	3/16" x 1/2"		13/64"	13/32"	467
18679	1	Gray	1"		7/16"	13/16"	462
18680	1	Black	1-1/32"		9/32"	1-3/32"	462
18682	1	Black	1/2"		1/4"	3/4"	452
18683	1	Black	23/64"		3/16"	7/16"	449
18684	1	Black	3/8"		5/32"	3/8"	449
18688	1	Gray	1-1/32"		9/32"	1-3/32"	462
18692	3	Natural	5mm x 15mm		5mm Hole	10mm	471
18746	Misc.	Black	30mm		15mm x 18mm	10mm	466
18771	1	Black	1"		19/64"	1-1/16"	462
18815	1	Black	9/16"		5/16"	3/4"	452
18818	6	Natural	7mm x 16mm		5mm	12mm	473
18824	10	White	15mm	13mm	9mm	9.5mm	491
18827	2	Black	25/32"		5/16"	7/16"	465
18842	6	Black	30mm		8.5mm	17mm	477
18844	10	White	18mm	13mm	10mm	13mm	497
18848	7	Yellow	3/4"	1/2"	3/8"	11/16"	488
18861	8	White	18mm	13mm	8.5mm x 8.5mm	12mm	481
18862	10	Green	23/32"	19/32"	5/16"	5/8"	502
18874	10	Gray	18mm	13mm	9.5mm	15mm	500
18875	8	White	19mm	13mm	11mm	15mm	484
18876	10	White	18mm	13mm	9mm x 9mm	14mm	498
18877	3	Orange	5mm x 15mm		6mm	10mm	472
18878	6	Black	30mm		6mm	16mm	477
18897	1	Black	13/32"		13/64"	7/8"	451
18915	10	White	23/32"	1/2"	5/16"	9/16"	501
18930	10	Yellow	18mm	13mm	9mm	18mm	504
18936	14	White	19/32"	39/64" x 7/16"	5/16"	1/2"	507
18948	1	Black	7/16"		7/32"	11/16"	451
18950	10	Black/White	18mm	13mm	10mm	13mm	497
19016	10	Dark Gray	18mm	13mm	9.5mm	15mm	500
19108	10	Natural	18mm	13mm	9.5mm	14mm	499
19109	10	Natural	15mm	13mm	9.5mm	11mm	494
19112	6	Black	30mm		8mm	16mm	477
19113	6	Black	25mm		8mm	12mm	476
19114	4	Black	12mm		8.5mm	9mm	477

Sec. 19

RETAINER SPECIFICATION CHART

Recommended Hole Size: .030" - .060" smaller than stem diameter



Auveco Part No.	Type	Color	Bottom Head Diameter	Top Head Diameter	Stem Diameter	Stem Length	Page No.
19116	3	Natural	5mm x 15mm		6mm	10mm	472
19121	1	Gray	20mm		8mm	20mm	458
19123	Misc.	Black	17mm		7mm	12mm	476
19124	4	Black	16mm		10mm	10mm	478
19127	1	Black	1"		1/4"	25/32"	459
19129	10	Yellow	18mm	13mm	9.5mm	14mm	502
19145	10	Gray	17mm	13mm	9mm	12mm	495
19149	1	Black	3/8"		7/32"	5/8"	451
19155	2	Black	1-9/32"		3/8"	3/4"	466
19171	3	Green	5mm x 15mm		5mm Hole	10mm	471
19197	1	Gray	25mm		8mm	20mm	461
19203	10	Natural	18mm	13mm	11mm	11mm	495
19210	10	Natural	18mm	13mm	10mm	14mm	501
19213	7	Natural	3/4"	1/2"	11/32"	3/4"	487
19250	1	White	11/16"		5/16"	13/16"	457
19257	10	Maroon	18mm	13mm	9.5mm	14mm	499
19270	9	White	20mm	18mm	8mm	24mm	490
19275	9	White	20mm	18mm	8mm	13mm	490
19312	1	Black	16mm		5mm	13mm	452
19320	8	White	16mm	12mm	9mm	11mm	481
19323	6	Black	26mm		10mm	8mm	477
19325	3	Brown	5mm x 13mm		7mm	6mm	469
19331	6	Black	14mm		7mm	11mm	475
19334	8	Natural	16mm	12mm	9mm	15mm	485
19338	1	Black	1-1/4"		5/16"	11/16"	464
19356	9	White	20mm	18mm	8mm	20mm	490
19368	3	Natural	5mm x 15mm		5mm Hole	9mm	470
19373	1	Light Gray	19/32"		9/32"	27/32"	458
19386	10	Natural	20mm	15mm	9mm	15mm	500
19418	1	Black	13/32" x 1"		9/32"	9/16"	469
19425	3	Natural	9/32" x 1/2"		7/32"	21/32"	468
19428	Misc.	White	20mm	18mm	8mm	19mm	505
19449	1	Black	13/64" x 7/8"		7/32"	5/8"	469
19466	10	White	17mm	13mm	9.5mm	12mm	494
19467	6	Black	13mm		6mm	10mm	474
19468	1	Black	28mm		6mm	10mm	464
19470	1	Black	16mm		4mm	21mm	454
19481	3	Blue	5mm x 15mm		6mm Hole	8mm	470
19483	3	Black	8mm x 18mm		7mm	15mm	473
19506	1	Black	16mm		5mm	16mm	452
19524	Misc.	Green	15mm		8mm	13mm	508
19527	10	Yellow	20mm	18mm	8mm	13mm	490
19541	1	Black	1"		9/32"	5/8"	460
19628	10	White	18mm	15mm	8.5mm	14mm	502
19643	1	Black	16mm		6mm	16mm	453
19655	2	Black	1-3/16"		3/8"	3/4"	465
19667	1	Black	3/4"		7/32"	11/16"	454
19673	1	Black	10mm x 15mm		5mm	10mm	451
19678	3	White	5mm x 15mm		6mm	10mm	468
19682	4	Black	11mm		7mm	8mm	477

RETAINER SPECIFICATION CHART

Recommended Hole Size: .030" - .060" smaller than stem diameter



Auveco Part No.	Type	Color	Bottom Head Diameter	Top Head Diameter	Stem Diameter	Stem Length	Page No.
19683	3	Black	6mm x 16mm		7mm	14mm	472
19684	3	Blue	7mm x 16mm		6mm Hole	12mm	472
19686	1	Black	12mm		5mm Sq.	6mm	449
19719	8	White	18mm	13mm	10mm	11mm	482
19724	3	White	6mm x 16mm			15mm	473
19728	3	Black	8mm x 17mm		7mm Hole	14mm	472
19729	4	Black	25mm		9mm	10mm	476
19731	10	White	17mm	13mm	9.5mm	13mm	495
19744	1	Black	16mm		6mm	27mm	454
19749	3	White	5mm x 15mm		6mm Hole	10mm	471
19760	1	Black	25mm		8mm	24mm	460
19774	1	Black	13/32"		5/16"	1-5/16"	455
19775	Misc.	White	18mm	13mm	8mm	18mm	504
19790	1	Gray	11/16"		5/16"	13/16"	457
19802	10	White	16mm	12mm	8mm	24mm	488
19804	Misc.	White	22mm	16mm	9mm	15mm	505
19810	7	Black	13mm	12mm	8mm	19mm	487
19834	1	Black	3/4"		5/16"	1-1/16"	459
19836	1	Black	7/16"		7/32"	11/16"	451
19837	1	Black	3/4"		11/32"	13/16"	459
19842	Misc.	Black	18mm		11mm	22mm	455
19845	1	Med. Graphite	1"		5/16"	1-3/4"	463
19846	1	Black	1"		5/16"	1-3/4"	463
19850	3	Natural	5mm x 15mm		5mm	8mm	469
19855	1	Black	23/32"		15/64" x 9/32"	3/4"	457
19893	1	Black	5/8"		1/4"	3/4"	454
19898	10	Yellow	18mm	13mm	9.5mm	13mm	499
19910	10	Yellow	18mm	13mm	9mm x 9mm	14mm	499
20164	2	Black	30mm		8mm	12mm	466
20165	1	Black	10mm		6mm	12mm	449
20177	1	Gray	11/16"		5/16"	1-3/8"	455
20180	3	Black	6.5mm x 11mm		5.5mm	12mm	468
20181	3	White	6.5mm x 16mm		6mm	8mm	470
22533	4	Natural Nylon	9.5mm	6.5mm x 14mm	7mm	8mm	470
20182	3	White	6.5mm x 16mm		6mm	6mm	467
20184	1	Black	16mm		8mm	16mm	453
20188	11	White	18mm	13mm	8.5mm	11mm	505
20189	1	Black	1"		5/16"	5/8"	459
20190	Misc.	Carmel/White	20mm	13mm	8.5mm	16mm	503
20192	1	Black	11/16"		5/16"	1-3/4"	456
20252	11	Black	18mm	14mm	9mm	14mm	505
20253	12	White	18mm	14mm	9mm	15mm	506
20256	1	Black	15mm		4.5mm	14mm	452
20262	1	Black	1"		7/16"	9/16"	461
20274	7	White	23mm	13mm	6.5mm	20mm	488
20279	Misc.	White	13/16" x 1-7/16"	5/16" x 3/4"	5/16"	7/8"	507
20281	1	Black	21mm		13mm	27mm	461
20311	1	Black	14mm		7mm	9mm	451
20316	1	Black	1"		5/16"	13/16"	461
20319	1	Black	25mm		9mm	12mm	459

RETAINER SPECIFICATION CHART

Recommended Hole Size: .030" - .060" smaller than stem diameter



Auveco Part No.	Type	Color	Bottom Head Diameter	Top Head Diameter	Stem Diameter	Stem Length	Page No.
20334	1	Black	18mm		7.5mm	20mm	454
20338	9	White	25/32"	11/16"	5/16"	1-1/4"	491
20341	Misc.	Black	22mm		10.5mm	10mm	507
20344	1	Black	7/16"		7/32"	5/16"	450
20345	1	Gray	1"		1/4" x 5/16"	1-1/8"	462
20360	1	Black	15/16"		3/8"	3/4"	459
22576	1	Black	25mm		7.3mm	21mm	459
20362	1	Black	25mm		13mm	15mm	461
20366	1	Black	22mm		7.5mm	35mm	456
20381	6	Black	16mm		7mm	16mm	476
20399	1	Black	3/4"		7/32"	15/32"	453
20411	10	Black	14.5mm	13mm	9.5mm	12mm	495
20427	10	Gray/White	20mm	15mm	9mm	18mm	503
20428	10	Green/White	20mm	15mm	9mm	18mm	503
20437	10	White	18mm	13mm	8.5mm x 8.5mm	15mm	496
20443	3	Black	5mm x 15mm		7mm	10mm	471
20444	10	White	19mm	20mm	11mm	17mm	503
20473	8	White	18mm	13mm	11mm	14mm	484
20515	10	Yellow/White	20mm	15mm	9mm	14mm	500
20528	1	Black	9mm		6mm	14mm	449
20531	1	Black	21mm		7.5mm	25mm	455
20541	1	Tan	35mm		7.5mm	20mm	465
20543	4	Black	26mm		12mm	14mm	479
20558	10	White	15mm	13mm	8.5mm x 9.5mm	11mm	492
20559	10	Blue	18mm	13mm	9mm x 9mm	11mm	493
20563	10	White	22mm	16mm	9mm	15mm	504
20571	8	White	18mm	13mm	9mm	9mm	481
20575	10	Yellow/White	18mm	13mm	10mm	13mm	496
20576	8	Yellow	14mm x 18mm	10mm x 13mm	8.5mm x 8.5mm	9mm	481
20609	1	Black	30mm		15mm x 20mm	14mm	466
20610	10	White	16mm	13mm	9mm	15mm	499
20611	8	Blue	16mm	12mm	3mm	7mm	480
20616	10	White	18.5mm	19.5mm	11mm	17mm	503
20624	1	Black	18mm		7.5mm	33mm	455
20625	1	Tan	25mm		8mm	29mm	462
20633	10	Turquoise	18mm	13mm	8.5mm x 9mm	14mm	497
20634	7	White	16mm	13mm	7mm	26mm	489
20642	8	Gray	16mm	13mm	9mm	13mm	481
20668	10	White	18mm	13mm	9mm	14mm	496
20669	10	Black	18mm	13mm	9mm	15mm	499
20671	5	Black	20mm		9.5mm	15mm	476
20672	7	White	16mm	13mm	4mm	13mm	483
20735	11	Black	18mm	11.5mm	9mm	14mm	505
20760	3	Natural	5mm x 15mm		8mm	7mm	569
20761	1	Black	18mm		8.5mm	32mm	456
20765	10	Yellow	18mm	15mm	10mm	15mm	502
20770	4	Yellow	10mm		9mm	14.5mm	477
20814	9	White	25/32"	11/16"	5/16"	13/16"	491
20829	7	Black	18mm	14mm	8mm	15mm	487
20831	3	Blue	5mm x 14mm		6.5mm	10mm	471

RETAINER SPECIFICATION CHART

Recommended Hole Size: .030" - .060" smaller than stem diameter



Auveco Part No.	Type	Color	Bottom Head Diameter	Top Head Diameter	Stem Diameter	Stem Length	Page No.
20866	Misc.	White	1/2"		11/32"	7/16" & 7/8"	508
20874	1	Black	25mm		7mm	23mm	455
20878	1	Black	19mm		7.5mm	16mm	458
20879	10	Green	17mm	13mm	9mm	14mm	496
20881	8	White	16mm	13mm	8mm	13mm	482
20882	6	Black	20mm		7mm	15mm	476
20893	1	Black	12.5mm		7.5mm	15mm	450
20926	1	Black	18mm		7.5mm	44mm	456
20932	8	White	18mm	14mm	12mm	14mm	484
20944	7	Green	25mm	18mm	8mm	24mm	488
20949	10	Black & Blue	16mm	13mm	8mm	12mm	503
20959	10	Blue	15mm	13mm	9.5mm	13mm	495
20983	10	White	18mm	13mm	9mm	13mm	494
20995	15	White	19.5mm	19mm		22mm	489
20996	15	Yellow	19.5mm	19mm		22mm	489
20998	15	Black & White	19.5mm	19mm		22mm	489
20999	15	Green & Yellow	19.5mm	19mm		22mm	483
21012	8	Black	18mm	13mm	9.5mm	14mm	458
21026	1	Black	20mm		8.5mm	20mm	501
21059	10	Blue	18mm	12mm x 13mm	8.5mm x 8.5mm	14mm	494
21070	10	White	16mm	13mm	9.5mm	10mm	499
21087	10	Orange	18mm	12mm	9.7mm	14mm	483
21088	8	White	17mm	13mm	9.5mm	14mm	460
21090	1	Black	1"		3/8"	3/4"	488
21091	8	Black	25mm	13mm	10.5mm	14mm	488
21102	10	White	18mm	13mm	8.5mm	14mm	497
21105	4	Black	20mm		14mm	10mm	479
21107	7	White	16mm	13mm	4mm	13mm	483
21118	10	White	18mm	13mm	10mm	14mm	498
21125	1	Black	20mm x 36mm		17mm	25mm	469
21131	10	Black	18mm	12mm	9.5mm	13mm	503
21137	10	Black	15mm	13mm	10mm	8mm	491
21138	10	White	18mm	14mm	9mm	14mm	498
21143	1	Black	8.5mm x 14mm		5mm x 7.5mm	14mm	469
21144	Misc.	Black	27mm	21.5mm	11mm	19mm	507
21149	10	White	15mm	13mm	9.5mm	11mm	492
21169	10	White	22mm	16mm	11mm	17mm	503
21188	10	Pink	18mm	15mm	10mm	12mm	492
21189	10	Black	19mm	20mm	11mm	16mm	504
21199	1	Black	18mm		7.5mm	20mm	453
21206	10	Orange	18mm	13mm	8.5mm	14mm	496
21208	10	Gray	18mm	13mm	9mm	12mm	494
21211	4	Black	24mm		9mm	12mm	466
21226	8	Black	18mm	13mm	9mm	10mm	483
21227	1	Tan	45mm		9.5mm	20mm	465
21229	6	Black	6.4mm x 16mm		3.5mm x 6mm	10mm	471
21240	10	Green	18mm	14mm	9mm	10mm	463
21241	1	Black	26mm		7.5mm	28mm	500
21247	10	Green	18mm	15mm	12mm	14mm	500
21248	1	Tan	25mm		7.5mm	22mm	460

RETAINER SPECIFICATION CHART

Recommended Hole Size: .030" - .060" smaller than stem diameter



Auveco Part No.	Type	Color	Bottom Head Diameter	Top Head Diameter	Stem Diameter	Stem Length	Page No.
21250	10	Black	16mm	13mm	11mm	14mm	502
21253	1	Gray	20mm		6mm	15mm	454
21254	1	Black	20mm		8mm	8mm	479
21257	1	Black	23mm		8mm	20mm	459
21287	1	Opal Gray	25mm		8mm	58mm	463
21288	1	Black	28mm		6mm	10mm	464
21289	10	Yellow	18mm	12.5mm	9.5mm	14mm	497
21295	6	Black	10mm		6mm	8mm	473
21296	6	Black	13mm		7mm	10mm	474
21301	1	Black	25mm		5.8mm	25.5mm	460
21303	1	Black	18mm		7mm x 7mm	13mm	452
21307	4	Black	9mm		5.5mm	7mm	477
21313	1	Black	31mm		7.6mm	13mm	464
21329	10	Black	18mm	15mm	9mm	13mm	497
21332	1	Tan	20mm		6mm	15mm	454
21333	10	Blue	18mm	13mm	10mm	14mm	502
21334	3	White	5mm x 15mm		8mm	8mm	469
21338	1	Black	25.4mm		8mm	27mm	460
21346	7	White	12mm x 16mm	15mm	5mm	34mm	488
21349	1	Gray	18mm		8mm	16mm	453
21350	1	Tan	18mm		8mm	16mm	453
21360	10	White	16mm	13mm	10mm	12mm	496
21364	8	Green	17mm	15mm	9mm	14mm	485
21365	8	Blue	17mm	13mm	9mm	13mm	482
21379	10	Black	18.5mm	19.5mm	11mm	16mm	503
21380	1	Black	28mm		8mm	17mm	464
21381	1	Black	5mm x 13mm		8mm	11mm	468
21382	1	Black	6mm x 16mm		8mm	14mm	468
21383	7	White	19mm	19mm	7mm	22mm	489
21392	1	Black	23mm		6.5mm	16mm	458
21398	Misc.	Black	18mm	22m	9mm	11mm	507
21410	10	White	18mm	13mm x 18mm	10.7mm	12mm	491
21412	8	Gray	18.5mm	14mm	12mm	13mm	486
21414	10	White	18mm	13mm	9mm	13mm	496
21415	Misc.	Tan & White	28.5mm		9.5mm	11mm	508
21421	1	Black	30mm		7.7mm	13mm	464
21443	1	Black	30mm		7.8mm	15mm	464
21450	8	Black	18mm	13.5mm	9mm	14mm	482
21458	1	Black	10mm		5.5mm	7mm	449
21488	8	Gray	17mm	13mm	9mm	14mm	482
21489	8	Yellow	17mm	15mm	9mm	14mm	485
21494	11	Natural	18mm	12mm	9.5mm	12mm	505
21495	8	Blue	18mm	13mm	9mm	14mm	482
21496	8	White	18mm	12mm	10mm	12mm	481
21497	Misc.	Black	6mm x 15mm		7.5mm	17mm	478
21502	10	White	15mm	13mm	9.5mm	14mm	498
21509	Misc.	White	18mm	12mm	10mm	16mm	480
21519	1	Black	12mm		6mm	15mm	450
21520	4	Black	14mm		6.5mm	10mm	478
21532	7	White	12mm	13mm	8mm	25mm	488

RETAINER SPECIFICATION CHART

Recommended Hole Size: .030" - .060" smaller than stem diameter



Auveco Part No.	Type	Color	Bottom Head Diameter	Top Head Diameter	Stem Diameter	Stem Length	Page No.
21535	15	White	19.5mm	19.5mm		26mm	489
21536	15	Yellow	19.5mm	19.5mm		26mm	489
21538	8	Charcoal	18mm	13mm	9.5mm	13mm	483
21548	1	Black	10mm		6mm	10mm	479
21551	Misc.	Black	12mm	9mm	7mm	13mm	480
21552	3	White	9mm	5mm x 15mm	6.5mm	4mm	495
21554	10	Black	15mm	13mm	9.5mm	11mm	495
21560	1	Black	20mm		7mm	15mm	454
21565	3	White	5mm x 14mm		7mm	8.5mm	469
21567	8	Gray	18mm	11mm x 15mm	9.7mm	12mm	482
21573	5	Black	9mm		6.5mm	13mm	473
21574	10	White	15mm	13mm	9.5mm	11mm	494
21584	10	White	18mm	13mm	9.3mm	10mm	491
21588	4	Black	8mm		5.3mm	7mm	477
21589	1	Black	18mm		7.7mm	15mm	452
21591	8	Black	17mm	11mm x 14mm	9.7mm	12mm	482
21626	6	Black	12mm		6.5mm	11mm	474
21627	1	Black	9mm		5.3mm	8mm	449
21630	1	Black	20mm		6mm	22mm	454
21633	3	White	6mm x 16mm		6.5mm	12mm	472
21634	Misc.	Black	16.5mm		9mm	13mm	476
21638	10	White	15mm	13mm	9.5mm	11mm	494
21643	6	Black	7mm x 13mm		7.5mm	13mm	475
21652	Misc.	Black	30mm		15mm x 21mm	14mm	466
21654	10	White	18mm	13mm	9.5mm	14mm	497
21661	1	Black	20mm		7mm	10mm	453
21673	1	Black	20mm		9mm	17mm	454
21675	10	Green	18mm	13mm	9.5mm	11mm	494
21676	10	Yellow	18mm	13mm	9.5mm	12mm	495
21678	8	Black	18.5mm	14mm	12mm	14mm	484
21679	1	Black	19mm		8mm	26mm	455
21686	10	Green	18mm	13mm x 16mm	9mm	9mm	492
21690	8	White	16mm	12mm	8mm x 8mm	14mm	485
21693	1	Black	16mm		4.7mm x 4.7mm	12mm	452
21694	3	Black	8mm	5mm x 14mm	6.3mm	5mm	469
21695	6	Black	4.5mm x 11mm		6.5mm	9mm	474
21696	7	Pale Yellow	16mm	12mm	4mm	6.5mm	480
21704	3	Green	9.5mm	5mm x 15mm	7mm	11mm	471
21705	3	Yellow	7.5mm	5mm x 15mm	6.5mm	7mm	471
21707	3	White	6.5mm		7mm	8.5mm	471
21708	Misc.	Black	22.5mm		9mm	12mm	507
21755	1	Black	15mm		6.5mm	14mm	452
21756	1	Clear	11/16"		5/16"	13/16"	457
21757	5	Black	18mm		9mm	15mm	476
21773	3	Black	8mm	5mm x 11mm	6mm	7mm	471
21787	8	White	18mm	12mm	9.5mm	16mm	486
21788	10	White	18mm	14mm	9.5mm	14mm	500
21795	Misc.	White	18mm	13mm			487
21805	1	Black	35mm		10mm x 10.5mm	22mm	461
21806	1	Black	35mm		10.5mm	22mm	461

RETAINER SPECIFICATION CHART

Recommended Hole Size: .030" - .060" smaller than stem diameter



Auveco Part No.	Type	Color	Bottom Head Diameter	Top Head Diameter	Stem Diameter	Stem Length	Page No.
21819	8	Yellow	17.5mm	13mm	10mm	16mm	485
21822	10	White	18mm	13mm	8.5mm x 9mm	14mm	498
21853	8	Yellow	17.5mm	13mm	10.5mm	15mm	485
21854	1	Black	20mm		7mm	33mm	508
21871	11	White	16.5mm	13mm	8.7mm	11mm	481
21873	10	White	18mm	14mm	9.5mm	14mm	500
21884	10	White	18mm	11mm	8mm	13mm	501
21894	10	Black	22mm	22mm	9.3mm	14mm	459
21895	10	Blue	18mm	13mm	12mm	12mm	495
21905	1	Gray	21mm		7.5mm	19mm	459
21916	9	Yellow	18mm	12.3mm	12mm	13mm	495
21917	9	Yellow	18mm	12.3mm	12mm	13mm	495
21918	5	Black	7mm x 12mm		8mm	9mm	473
21920	4	Black	9mm x 18mm		8.5mm	10mm	473
21936	1	Black	11.5mm		5.5mm	12mm	450
21943	5	Gray	12mm		7.5mm	13mm	473
21944	10	Green/White	18mm	12.5mm	10.5mm	12mm	496
21949	3	Black	5mm x 12mm		7mm	10mm	472
21975	11	White	17mm	14mm	9mm	10mm	481
21978	12	White	17mm	14mm	9mm	10mm	495
21980	3	Yellow	5mm x 13mm		5.7mm	5mm	470
21981	6	Black	5.5mm x 17mm		5mm	7mm	467
21997	7	Black/White	28mm	19mm	10mm	12mm	508
22001	6	Black	9mm x 13mm		7.5mm	10mm	475
22003	10	White	18mm	13mm	11mm	13mm	496
25269	10	Natural White	18mm	13mm	9.5mm	13mm	496
22004	10	White	18mm	13mm	9mm	15mm	498
22005	10	White	18mm	15mm	10.7mm	12mm	495
22006	10	White	18.5mm	13mm	10.3mm	15mm	501
22008	10	Black	16mm	14mm	10.3mm	10mm	491
22009	10	White	15mm	13mm	9.6mm	13mm	497
22012	10	Blue	18mm	15mm	10.5mm	39mm	504
22031	10	Gray	18mm	16.5mm	10mm	15mm	503
22034	9	White	20mm	19mm	9mm	19mm	504
22046	4	Black	9.3mm x 14.5mm		7mm	16mm	478
22048	10	White	18mm	13mm	9mm x 9.5mm	11mm	492
22053	1	Black	25mm		11mm	45mm	463
22054	6	Black	20mm		7mm	16mm	476
22056	8	White	18mm	13mm	8.5mm x 8.5mm	13mm	483
22057	8	Black	18mm	13mm	9mm	12mm	481
22060	3	Black	6.5mm x 16mm		3.5mm x 5.5mm	8mm	470
22063	Misc.	White	12mm	13mm		14mm	483
22071	Misc.	Black	20mm			15mm	479
22073	Misc.	Black	32mm			12mm	479
22075	1	Black	20mm		8.7mm	16mm	454
22082	6	Black	26mm			14mm	477
22086	Misc.	Black	22mm	30mm		14mm	508
22090	10	Brown	20mm	11.6mm x 15mm		16mm	504
22091	1	Black	20mm		7mm	24mm	508
22092	8	Black	18.5mm	30mm		14mm	508

RETAINER SPECIFICATION CHART

Recommended Hole Size: .030" - .060" smaller than stem diameter



Auveco Part No.	Type	Color	Bottom Head Diameter	Top Head Diameter	Stem Diameter	Stem Length	Page No.
22093	7	Black	12.3mm	12.3mm	5.5mm	17mm	487
22103	4	Black	20mm		9mm	9mm	466
22107	Misc.	Black	6mm x 15mm		5.6mm x 7mm	12mm	468
22133	Misc.	Red	16mm	10mm		7.8mm	483
22149	10	Blue	18mm	14mm	10mm	16mm	502
22152	10	White	18mm	12.5mm	11.5mm	10mm	492
22153	8	White	15mm	8mm x 10mm	12mm	8mm	481
22156	10	White	17mm	13mm		13mm	496
22157	10	Yellow	18mm	13mm	12mm	11mm	497
22162	3	Orange	5mm x 15mm		8mm	8mm	469
22168	Misc.	Black	18mm x 21.5mm			9mm	466
22179	Misc.	Black	18mm	13mm	10.8mm	14.5mm	482
22180	1	Black	23mm		7.6mm	30mm	456
22206	9	White	15mm	13mm	9.6mm x 9.6mm	14mm	500
22207	8	Black	17mm	11mm x 14mm	9.7mm	12mm	483
22209	4	Black	20mm		9.6mm	19mm	479
22211	1	Black	23mm		8mm	15mm	464
22212	6	Black	4.3mm x 11mm		6.2mm	10mm	475
22214	6	Black	7.5mm		5.5mm	10mm	474
22220	10	White	19mm	14mm		14mm	501
22221	Misc.	Black	71mm			15mm	501
22229	10	Gray	18mm	14.5mm	9.5mm	14mm	476
22231	10	Black	12mm	10mm	8mm	9mm	500
22233	1	Black		32mm	8.5mm	16mm	465
22236	8	White	18mm	13mm	9.3mm	13mm	482
22237	10	White	18mm	13mm	9mm	13mm	496
22240	8	Yellow	17mm	15mm	9mm	14mm	482
22243	8	White	16mm	13mm	9.5mm	12mm	481
22244	8	White	17mm	14mm	10.8mm	11mm	487
22245	Misc.	Black	19mm			23mm	508
22250	7	Black	18mm	15mm	7.2mm	20mm	505
22251	Misc.	White	15mm	14.5mm	11mm	15mm	485
22252	10	Yellow	18mm	13mm	10.5mm	12mm	482
22254	Misc.	Black	31mm		7mm	12mm	479
22259	7	Black	21mm	13mm	7.4mm	14mm	487
22263	6	Black	16mm		8mm	11mm	476
22267	10	White	18mm	13mm	11mm	14mm	499
22269	Misc.	White	14.5mm	14.5mm	10mm	12mm	493
22278	8	Gray	17mm	13mm	9mm	14mm	485
22279	8	Yellow	17mm	15mm	9mm	15mm	485
22285	10	Red	18mm	14.3mm	9.5mm	13mm	495
22286	Misc.	White	14mm			10mm	476
22288	9	Green	18mm	13mm	9.5mm	15mm	502
25272	8	White	18mm	13mm	7.5mm	15mm	502
22302	3	Yellow	6.5mm	5mm x 15mm	8mm	8mm	470
22305	10	Yellow	17mm	13.3mm	9.3mm	13mm	494
22309	10	White	17mm	13.3mm	9.3mm	13mm	494
22310	3	White	9.5mm	16.5mm		13.5mm	469
22312	10	Gray	15mm	13mm	9.5mm	12mm	459
22313	10	Green	18mm	13mm	10mm	10mm	458

RETAINER SPECIFICATION CHART

Recommended Hole Size: .030" - .060" smaller than stem diameter



Auveco Part No.	Type	Color	Bottom Head Diameter	Top Head Diameter	Stem Diameter	Stem Length	Page No.
22315	Misc.	Gray	18mm	13mm	9mm	15mm	465
22320	3	Black	5mm	13mm	8mm	10mm	435
22321	3	Black	4.5mm	13mm	7.6mm	7.5mm	435
22325	3	Red	5mm x 15mm		7mm		438
22336	10	White	12mm	10mm	7.2mm	10mm	457
22337	3	White	9.3mm	5mm x 15mm	7mm	11mm	445
22338	1	Black	26mm		7.6mm	28mm	430
22343	10	Green	15mm	13mm	9.8mm	10mm	458
22355	3	Green	11mm	5mm x 15mm	8mm	9.5mm	470
22356	3	Pink	11mm	5mm x 5mm	8mm	9.5mm	437
22361	8	Pale Yellow	16mm	12mm	8mm	8mm	484
22364	10	Gray	18mm	13mm	9mm	13mm	497
22417	8	Blue	17mm	13.3mm	9.3mm	10mm	485
22432	Misc.	White	15mm x 19mm	11mm x 12mm	10.3mm	13mm	484
22449	1	Black	20mm		8mm	16mm	458
22461	8	White	22mm	16mm	12mm	19mm	504
22462	8	Blue	18mm	13mm	9.8mm	9mm	482
22469	10	Black	18mm	13mm	9.3mm	14mm	501
22478	8	Blue	18mm	13mm	9.5mm	13mm	484
22484	10	Yellow	18mm	13mm	9.3mm	13mm	498
22493	1	Black	18mm		7.5mm	45mm	465
22498	10	Gray	20mm	13.5mm	9.5mm	13mm	500
22499	Misc.	Yellow	18mm	13mm	9.5mm	13mm	502
22503	1	Black	18mm		8.5mm	19mm	458
22509	1	Black	24mm		4mm	23mm	467
22510	8	White	18.5mm	15mm	10.8mm	14mm	486
22512	8	Gray	18.5mm	14mm	11mm	14mm	486
22513	8	White	16mm	12mm	8mm	10mm	484
22521	1	Black	14mm		8mm	25mm	457
22526	3	Red	5mm x 13mm		5.5mm	6mm	468
22541	4	Black	12mm		8mm	10mm	478
22544	10	Green	18mm	13mm	9.3mm	12mm	501
22545	10	Tan	18mm	13mm	9mm	9mm	501
22551	3	Natural	12mm	5mm x 12mm	6mm	4.5mm	472
22553	3	Black	4mm x 10mm		6.5mm	7mm	467
22555	1	Black	20mm		7mm	13mm	454
22571	8	White	18mm	13mm	9.5mm	14.5mm	484
22572	10	White	18mm	13mm	10mm	14mm	500
22585	8	Green	18mm	15mm	9.5mm	12mm	505
22586	1	Black	10.6mm		5.5mm	8mm	449
22589	1	Black	26mm		10mm	10mm	460
22598	1	Black	16mm		8mm	16mm	453
22705	1	Black	16mm		7.7mm x 7.7mm	30mm	454
22712	10	Green	18mm	13mm	11mm	11mm	498
22716	10	Light Gray	10mm	13mm	8mm	9mm	457
22718	1	Black	15mm		5.7mm	19mm	451
22793	10	Beige	18mm	14mm	9mm	12mm	494
22794	1	Black	18mm		5.7mm	12mm	494
22819	8	White	12mm	10mm	8mm	9mm	480
22832	10	White	18mm	13mm	9.5mm	16mm	502

RETAINER SPECIFICATION CHART

Recommended Hole Size: .030" - .060" smaller than stem diameter



Auveco Part No.	Type	Color	Bottom Head Diameter	Top Head Diameter	Stem Diameter	Stem Length	Page No.
22839	Misc.	Natural	18mm	15mm	8.75mm	17mm	486
22845	10	Red	18mm	13mm	9mm	15mm	501
22853	Misc.	Black & White	17.5mm	15mm		10mm	493
22860	10	Gray	18mm	12.5mm	9.5mm	12.5mm	494
22862	10	White	18mm	13mm	9mm	12.5mm	481
22875	3	White	8.5mm	4.5mm x 7mm	5mm x 15mm	8.3mm	470
22885	14	Turquoise	18mm	13mm	8mm	27.5mm	504
22994	8	White	10mm	10mm	4.4mm x 7mm	8mm	480
22760	1	Dark Gray	26mm		8.6mm	39mm	458
22764	10	Red	18mm	13mm	9mm	11.5mm	499
22897	10	Blue	18mm	13mm	9mm	10mm	491
22898	1	Black	30mm		6mm	10mm	466
22899	8	White	19mm	13mm	11.5mm	19mm	486
22900	1	Black	14mm		8mm	12mm	451
22905	8	Black	16mm	13mm	9.3mm	14mm	485
22910	10	White	20mm	8 x 10mm	7 x 12mm	10mm	492
22924	1	Black	19mm		7.6mm	22mm	458
22927	1	Black	12.5mm		7mm	9mm	450
22948	10	Green	17mm	13mm	9.3mm	8.5mm	493
22950	10	Purple	13mm	13mm	9.4mm	14mm	492
23552	15	White	16mm	13mm	8.75mm	26mm	489
23553	15	Yellow/White	19.5mm	19.5mm	8.75mm	26mm	489
23559	10	Yellow	18mm	13mm	9.5mm	17mm	503
23592	2	Black	1-1/2" Sq.		9/32"	23/32"	467
23608	1	Black	12.4mm		7mm	13.3mm	451
23683	1	White	19mm	13mm	7.5 x 8.0mm	14.5mm	522
23700	10	Black	18mm	13mm	8.5mm	10mm	494
23737	5	Black	12mm		6.5mm	14mm	474
23745	5	Black	1"		5/16"	25/32"	461
23752	5	Black	12mm		6.5mm	15mm	474
23782	1	Black	19mm		8.9mm	18mm	460
23783	7	White	19mm	13mm	8.8mm	17mm	488
23802	1	Blue	13mm		7mm	21mm	451
23807	5	Black	8mm		4.5mm	13mm	475
23859	1	Black	20.5mm		8.5mm	21mm	459
23884	1	Black	19mm		7.5mm	10.5mm	458
23896	1	Black	32mm		8.4mm	20mm	462
23907	1	Black	17.8mm		7.8mm	13mm	457
23933	1	Black	17.8mm		7mm	15mm	452
23937	1	Black	11/16"		5/16"	13/16"	457
23961	4	White	12 x 15mm				480
23962	1	Black	14mm		4.6 x 4.9mm	14.5mm	452
23966	1	Black	25.4mm		7.7mm	20.5mm	462
23989	10	White	18mm	13mm	9.5mm	13mm	498
24162	7	Black	20mm		8.3mm	38mm	463
24181	3	White	19mm		8mm	32mm	455
24469	3	Yellow	5mm x 15mm				471
24484	1	Green	5mm x 15mm				467
24580	1	Black	14mm		8mm	30mm	456
25032	10	Pink	17mm	13mm	9mm	14mm	493

Sec. 19

RETAINER SPECIFICATION CHART

Recommended Hole Size: .030" - .060" smaller than stem diameter



Auveco Part No.	Type	Color	Bottom Head Diameter	Top Head Diameter	Stem Diameter	Stem Length	Page No.
25050	3	Green	10mm	6.5mm x 14mm	4.7mm x 7mm		470
25065	3	Black	7mm	4.7mm x 12mm	4.5mm x 12mm	7.5mm	470
25072	3	White	5mm x 11mm			10mm	468
25075	1	Black			5mm x 5.8mm	10mm	450
25076	4	Black	20mm		5mm x 8mm	10mm	478
25085	8	Orange	10mm	10mm	4.4mm x 7mm	8mm	480
25089	1	Gray	23mm	14mm	10.6mm	16mm	503
25091	4	Yellow	22mm	16mm	11mm	17mm	504
25093	8	Black/White	12.5mm	12mm	7.5mm x 9mm	14.7mm	497
25117	8	Orange	16mm	15mm	8mm	11mm	483
25155	10	Black/Yellow	22mm	16mm	8.75mm	18.5mm	490
25156	10	Black/White	22mm	16mm	8.75mm	18.5mm	490
25182	1	Gray	30mm		9.8mm	63.5mm	463
25185	5	Black	20mm		10mm	18mm	477
25194	10	Yellow	15mm	12.5mm	6.5mm x 9.5mm	14mm	499
25215	10	Orange	17mm	13.3mm	9.3mm	13mm	493
25219	1	Natural	25mm		7.5mm	44.5mm	456
25247	8	White	18mm	15mm	8.75mm	16.5mm	490
25248	8	Green/White	18mm	15mm	8.75mm	16.5mm	490
25249	8	Blue	18mm	13mm	8.75mm	16.5mm	492
25257	Misc.	Green	10mm	7mm	5.8mm	15mm	469
25260	7	White	15mm	12.5mm	5.8mm	15mm	487
25263	Misc.	Green & White	14mm	13mm	8mm	19mm	486
25283	8	White	17mm	10mm	7.3mm	9mm	486
25316	10	Gray	18mm	12.5mm	8mm x 10mm	12.5mm	493
25328	4	Black	11mm		5mm x 7mm	10mm	477
25334	8	Black	16mm	13mm	8mm x 13mm	12.5mm	481
25337	7	Green	16mm	13mm	3.7mm	11.5mm	480
25339	3	Gray	5mm x 11mm		6.3mm	9.5mm	468
25340	Misc	White/Black	19.5mm	21.5mm	7.5mm	11mm	507
25343	8	Black	17mm	16mm	8.5mm Sq.	9.5mm	508
25346	Misc.	Black	32mm			13.5mm	479
25347	3	White		5mm x 15mm		10mm	472
25351	8	Yellow	11mm	9mm	5.75mm x 10mm	10mm	480

PUSH-TYPE RETAINERS

Sec. 19

Refer to Retainer Specification Chart on pages 571-581
Listed smallest to largest by Head Diameter, Stem Length and then by Hole Diameter.



17227
(21077405)
Black Nylon

Door Handle to Door Hardware Attachment Push-Type Retainer
Head Diameter: 7mm
Stem Length: 10mm
Fits into 5mm Hole
2 Door & 4 Door Models
GM Saturn 1991 - On

UNIT PACKAGE: 25



21585
(909130003)
Black Nylon

Upper Grille Push-Type Retainer
Head Diameter: 9mm
Stem Diameter: 7mm
Fits into 4mm Hole
Subaru Baja, Legacy, & Outback
2006 - 2000

UNIT PACKAGE: 25



21780
(BMW: 51-47-8-166-992)
Black Nylon

Trunk Lid Compartment Trim & Wheel Well Push-Type Retainer
Head Diameter: 9mm
Stem Length: 7mm
Fits into 5mm Hole
3, 5, & M Series 1993 - On

UNIT PACKAGE: 25



14016
(GM: 16500308; Chry: 6500787)
Black Nylon

Tail Light Retainer
Large Head Diameter: 3/8" (9.5mm)
Stem Length: 7/16" (11mm)
Fits into 3/16" (4.8mm) Hole
GM & Chrysler

UNIT PACKAGE: 25



13999
(20363491)
Black Nylon

Body Side Moulding Push-Type Retainer
Large Head Diameter: 3/8" (9.5mm)
Stem Length: 1/2" (12.7mm)
Fits into 7/32" (5.6mm) Hole
GM 1979 - On

UNIT PACKAGE: 25



13230
(Mercedes: 000-990-03-92;
Volvo: 947-098)
Black Nylon

Push-Type Retainer
Head Diameter: 10mm
Stem Diameter: 7mm
Fit into 5mm Hole

UNIT PACKAGE: 50



22230
(Subaru: 909140059)
Black Nylon

Front & Rear Bumper Push-Type Retainer
Head Diameter: 10mm
Stem Length: 8.5mm
Fits into 5mm Hole
Subaru Forester, Impreza, Legacy,
Outback, WRX, XV Crosstrek 2008 - On

UNIT PACKAGE: 15



21663
(EA01-50-037)
Black Nylon

Push-Type Retainer
Head Diameter: 10mm
Stem Length: 9mm
Fits into 5mm Hole
Mazda 2, 3, CX7, CX9, MX3,
MX5 Miata & RX8 1992 - On

UNIT PACKAGE: 15



22125
(Toyota: 90467-05170)
Black Nylon

Front Bumper Push-Type Retainer
Head Diameter: 10mm
Stem Length: 10mm
Fits into 5mm Hole
Lexus IS 250, IS 350 & NX 300h and Toyota
Corolla, Highlander, Matrix & RAV4 2012 - On

UNIT PACKAGE: 25



24533
(91514-T0A-A01)
Nylon

Fender Moulding Push-Type Retainer
Hole Size: 6mm
Head Diameter: 10mm
Stem Length: 8mm
Honda-CRV & Pilot 2012 - On

UNIT PACKAGE: 20

PUSH-TYPE RETAINERS

Refer to Retainer Specification Chart on pages 571-581

Listed smallest to largest by Head Diameter, Stem Length and then by Hole Diameter.



21037

(000-990-84-92)
Black Nylon

Push-Type Retainer
Head Diameter: 10mm
Stem Length: 10mm
Fits into 6mm Hole
Mercedes-Benz 2005-On

UNIT PACKAGE: 25



20187

(BMW: 51-16-1-881-149;
Mercedes: 000-990-34-92;
VW: N-102-593-01)
Black Nylon

Radiator Housing Push-Type Retainer
Head Diameter: 10mm
Stem Length: 10mm
Fits into 6mm Hole
Body Styles 116, 123, 124, 136, 129, 140, 170, 201,
208, & 210 1974 - On
BMW & VW

UNIT PACKAGE: 15



22238

(VW: N-905-369-01)
Black Nylon

Bumper, Hood, Interior Trim & Quarter Panel Push-Type Retainer
Head Diameter: 10mm
Stem Length: 11mm
Fits into 5mm Hole
Audi 90, A4 & S4 and VW Beetle,
Golf & Jetta 1993 - On

UNIT PACKAGE: 25



21779

(BMW: 51-46-7-002-606)
Black Nylon

Front Bumper, Grille, Trunk Panel & Rear Window Push-Type Retainer
Head Diameter: 10mm
Stem Length: 11mm
Fits into 6.3mm Hole
3, 5, 7 & Z Series 1997 - On

UNIT PACKAGE: 25



21103

(90467-05090-B1)
Gray Nylon

Front Bumper Fascia Push-Type Retainer
Head Diameter: 10mm
Stem Length: 12mm
Fits into 5mm Hole
Toyota Corolla, Matrix & Scion 2008 - On

UNIT PACKAGE: 10



21233

(86157-3700)
Black Nylon

Hood Mounting Push-Type Retainer
Head Diameter: 10mm
Stem Length: 13mm
Fits into 5mm Hole
Hyundai Azera 2009 - On

UNIT PACKAGE: 25



23902

(51711-928-946)
Nylon

Drive Type Cowl Vent Push-Type Retainer
Head Size: 10mm x 12mm
Fits into 6mm Hole
BMW 5 & 7 Series

UNIT PACKAGE: 25



21218

(90467-05063-C0)
Black Nylon

Front Bumper Push-Type Retainer
Head Diameter: 11mm
Stem Length: 8mm
Fits into 5mm Hole
Toyota Corolla 2009 - On

UNIT PACKAGE: 15



19186

(90657-SB0-003)
Black Nylon

Front Bumper Cover Push-Type Retainer
Head Diameter: 11mm
Stem Length: 10mm
Fits into 8mm Hole
Acura Legend, Honda
Accord & Odyssey 1991 - On

UNIT PACKAGE: 10



21662

(S51S-51-833)
Black Nylon

Push-Type Retainer
Head Diameter: 11mm
Stem Length: 11mm
Fits into 7mm Hole
Mazda 3, MX5 Miata & RX8 2004 - On

UNIT PACKAGE: 15

PUSH-TYPE RETAINERS

Refer to Retainer Specification Chart on pages 571-581

Listed smallest to largest by Head Diameter, Stem Length and then by Hole Diameter.



14990

(22538102)
Black Nylon

Push-Type Retainer

Head Diameter: 7/16" (11mm)
Stem Length: 15/32" (11.9mm)
Fits into 15/64" (6mm) Hole
GM 1987 - On

UNIT PACKAGE: 50



14988

(Ford: N805229S;
GM: 15648833, 22595587)
Black Nylon

Push-Type Retainer

Head Diameter: 7/16" (11mm)
Stem Length: 11/16" (17.5mm)
Fits into 15/64" (6mm) Hole
Ford & GM 1987 - On

UNIT PACKAGE: 25



23734

(10017619)
White Plastic

**Rear Radiator Lower
Grille Push-Type Retainer**

Hole: 14/16"
Stem Length: 1/2"
Flange: 7/16"
Pontiac 1980 - On

UNIT PACKAGE: 25



17214

(GM: 10089262, 21042098;
Chrysler: 55075139)
Black Nylon

Push-Type Retainer

Head Diameter: 11mm (7/16")
Stem Length: 18mm (11/16")
Fits into 6mm (15/64") Hole
GM & Saturn 4 Door & Station Wagon 1987 - On

UNIT PACKAGE: 25

14987

Same as 17214 except **unit package** quantity

UNIT PACKAGE: 50



17383

(96057847)
Black Nylon

**Radiator Grille & Trim Panel
Push-Type Retainer**

Head Diameter: 11mm
Stem Length: 14mm
Fits into 7mm Hole
Geo Tracker & Prizm 1992-1989

UNIT PACKAGE: 10



22543

(Chrysler: 6509135-AA)
Black Nylon

**Cowl Grille & Exterior Trim
Push-Type Retainer**

Head Diameter: 11mm
Stem Length: 20mm
Fits into 6mm Hole
Dodge Journey & Ram 2011 - On

UNIT PACKAGE: 25



21249

(90467-07071-22)
Black Nylon

Bumper Cover Push-Type Retainer

Head Diameter: 11mm
Stem Length: 14mm
Fits into 7mm Hole
Toyota Yaris 2009 - On

UNIT PACKAGE: 25



19788

(10246149; 22657634)
Black Nylon

Rocker Panel Push-Type Retainer

Head Diameter: 11mm
Stem Length: 20mm
Fits into 6mm Hole
GM Achieva, Cutlass, Grand Am
& Malibu 1999 - On

UNIT PACKAGE: 25



21711

(Mercedes-Benz: 000-991-59-40)
Black Nylon & Santoprene Rubber

Push-Type Retainer

Head Diameter: 11mm
Stem Length: 16mm
Fits into 6mm Hole
CLS55, CLS500, C Class,
E Class & Slk Class 2006 - On

UNIT PACKAGE: 15



18032

(6502573)
Black Nylon

**Cowl Screen Attachment
Push-Type Retainer**

Head Size: 15/32" (11.9mm)
Stem Length: 9/16" (14.3mm)
Fits into 1/4" (6.4mm) Square Hole
Chrysler Concorde & LHS, Dodge Intrepid &
Eagle Vision 1993 - On

UNIT PACKAGE: 15

PUSH-TYPE RETAINERS

Refer to Retainer Specification Chart on pages 571-581

Listed smallest to largest by Head Diameter, Stem Length and then by Hole Diameter.



22920
(Mercedes: 001-990-22-92)
Black Nylon
Motion Sensor Push-Type Retainer
Head Diameter: 12mm
Stem Length: 5mm
Fits into 5mm Hole
Mercedes-Benz E 300, E 400, E43,
E 450, E 53 & E 63 S 2017 - On

UNIT PACKAGE: 25



16783
(66824-01G00)
Black Nylon
Push-Type Retainer
Head Diameter: 12mm
Stem Length: 8mm (Excluding the Pin)
Fits into 6mm Hole
Nissan

UNIT PACKAGE: 25



21935
(Renault & Dacia: 77-03-072-361)
Black Nylon

Push-Type Retainer
Head Diameter: 12mm
Stem Length: 10mm
Fits into 6mm Hole
Renault & Dacia

UNIT PACKAGE: 15



20636
(123-990-00-92)
Dark Gray Nylon
Push-Type Retainer
Head Diameter: 12mm
Stem Length: 10mm
Fits into 8.5mm Hole
Mercedes-Benz

UNIT PACKAGE: 15



21391
(N038-550-1)
Dark Gray Nylon
**Bumper, Exterior Trim, Fender,
Quarter Panel & Wheel Opening
Push-Type Retainer**
Head Diameter: 12mm
Stem Length: 11mm
Fits into 8mm Hole
Audi and Volkswagen EuroVan,
Golf, Jetta & Passat 2003 - 1985

UNIT PACKAGE: 25



20639
(000-990-44-92)
Black Nylon
Push-Type Retainer
Head Diameter: 12mm
Stem Length: 11mm
Fits into 5mm x 5mm Hole
Mercedes-Benz

UNIT PACKAGE: 25



20640
(000-990-40-92, 124-990-05-92-9051)
Black Nylon
Push-Type Retainer
Head Diameter: 12mm
Stem Length: 11mm
Fits into 5mm Hole
Mercedes-Benz

UNIT PACKAGE: 25



21882
(Peugeot & Citroen: 6991.F0;
Renault & Dacia: 77-03-072-261)
Black Nylon

Push-Type Retainer
Torx® Drive (T27)
Head Diameter: 12mm
Stem Length: 14mm
Fits into 6mm Hole
Peugeot, Citroen, Renault & Dacia

UNIT PACKAGE: 25



22303
(BMW: 51-16-8-197-908)
Black Nylon

**Upper Cover & Spoiler
Push-Type Retainer**
Head Diameter: 12mm
Stem Length: 13mm
Fits into 7mm Hole
BMW 1, 3, M3 & Z4 and Mini-Cooper Base, John
Cooper Works, Countryman & Paceman 2013 - On

UNIT PACKAGE: 15



21246
(22690838)
Black Nylon
Door Trim Push-Type Retainer
Head Diameter: 12mm
Stem Length: 14mm (Excluding the Pin)
Fits into 6mm Hole
Chevrolet Malibu & Pontiac G6 2004 - On

UNIT PACKAGE: 25



19787
(22657634)
Black Nylon
**Fender & Rocker Panel
Push-Type Retainer**
Head Diameter: 12mm
Stem Length: 17mm
Fits into 6mm Hole
Chevrolet Malibu, Oldsmobile Achieva &
Cutlass and Pontiac Grand Am 1999 - On

UNIT PACKAGE: 25

PUSH-TYPE RETAINERS

Sec. 19

Refer to Retainer Specification Chart on pages 571-581

Listed smallest to largest by Head Diameter, Stem Length and then by Hole Diameter.



19522
(22644361)
Black Nylon

Door Sill Trim Plate Push-Type Retainer

Head Diameter: 12mm
Stem Length: 18mm
Fits into 6mm Square Hole
Chevrolet Malibu, Olds Achieva
& Cutlass 1997 - On

UNIT PACKAGE: 15



21875

(Peugeot & Citroen: 6555.LE;
Renault & Dacia: 77-03-072-236)
Black Nylon

Push-Type Retainer

Torx® Drive (T27)
Head Diameter: 12.5mm
Stem Length: 9mm
Fits into 6mm Hole
Peugeot, Citroen, Renault & Dacia

UNIT PACKAGE: 25



22201

(BMW: 51498166702)

Trim Panel Push-Type Retainer

Head Diameter: 12.5mm
Stem Length: 12mm
Fits into 8.5mm Hole
BMW 1, 2, 3, 5, 6, 7, X & Z Series
1995 - On

UNIT PACKAGE: 15



14995

(GM: 10195515;
Ford: N805026S;
Chrysler: 4696488, 6503163)
Black Nylon

Push-Type Retainer

Head Diameter: 1/2" (12.7mm)
Stem Length: 1-13/64" (30.5mm)
Fits into 9/32" (7mm) Hole
GM, Ford & Chrysler 1987 - On

UNIT PACKAGE: 25



25412

(Nissan: 79916-JD00A)
Black Nylon

Liftgate Push-Type Retainer

Head Diameter: 13mm
Stem Length: 8.5mm
Stem Diameter: 6.3mm x 7mm
Fits into 6.3mm Hole
Shoulder Length: 3.5mm
Nissan Rouge Sport 2019 - On

UNIT PACKAGE: 25



17287

(90687-SB0-003, 90687-SB0-013)
Black Nylon

Cowl Vent Panel Retainer

Head Diameter: 13mm
Stem Length: 11mm
Fits into 6mm Hole
Honda Prelude 1983 - On

UNIT PACKAGE: 2.5



22830

(VW: N-105-835-01-9B9)
Black Nylon

Bumper, Fender, Interior Trim & Seat Release Handle Push-Type Retainer

Top Head Diameter: 17mm
Bottom Head Diameter: 13mm
Stem Length: 12mm
Fits into 8mm Hole
Audi A3, A4, A5, A8, Allroad, Q3, RS5,
S3, S4, S5 & S8 2009 - On
Volkswagen Beetle 2013 - On

UNIT PACKAGE: 25



22155

(Land Rover: LR033144)
Black Nylon

Pillar, Rocker & Floor Moulding Push-Type Retainer

Head Diameter: 13mm
Stem Length: 13mm
Fits into 8mm Hole
Land Rover HSE &
Range Rover 2012 - On

UNIT PACKAGE: 15



20314

(000-990-37-92)
Black Nylon

Trunk Trim & General Purpose Push-Type Retainer

Head Diameter: 13mm
Stem Length: 14mm
Fits into 8mm Hole
Mercedes-Benz SL500 &
SL600 Convertible 1999 - On

UNIT PACKAGE: 15



21849

(Toyota: 90467-05136)
Black Nylon

Inner Door Lock Plate, Engine Cover & Outside Air Duct Push-Type Retainer

Head Diameter: 13mm
Stem Length: 15mm
Fits into 5.5mm Hole
Lexus & Toyota 2012 - On

UNIT PACKAGE: 25

PUSH-TYPE RETAINERS

Refer to Retainer Specification Chart on pages 571-581

Listed smallest to largest by Head Diameter, Stem Length and then by Hole Diameter.



21172

(W713202-S300,
W713445-S300)
Black Nylon

Bumper Push-Type Retainer

Head Diameter: 13mm
Stem Length: 18mm
Fits into 8mm Hole
Ford Fusion 2006 - On

UNIT PACKAGE: 15



19355

(15960621)
Black Nylon

**Rear Door Radio Speaker
Push-Type Retainer**

Head Diameter: 17/32" (13.5mm)
Stem Length: 1-5/64" (27.5mm)
Fits into 1/4" (6.4mm) Hole
GM Trucks C & K 1, 2 1995 - On

UNIT PACKAGE: 25



20196

(90467-06133-CO)
Black Nylon

Rocker Panel Push-Type Retainer

Head Diameter: 14mm
Stem Length: 8mm
Fits into 6mm Hole
Toyota 4-Runner 1998 - On

UNIT PACKAGE: 15



19726

(94858343)
Black Nylon

**Door Trim Panel
Push-Type Retainer**

Head Diameter: 14mm
Stem Length (Excluding Pin): 8mm
Fits into 6mm Hole
Geo Prizm 1998 - On

UNIT PACKAGE: 15



19645

(94858864)
Gray Nylon

**Door Trim Panel
Push-Type Retainer**

Head Diameter: 14mm
Stem Length (Excluding Pin): 8mm
Fits into 6mm Hole
Geo Prizm 1998 - On

UNIT PACKAGE: 15



23935

(90467-06133, 94858343)
Gray Nylon

Rocker Panel Push-Type Retainer

Hole: M6
Flange: 14mm
Stem Length: 9mm (excluding pin)
Toyota 1998 - On ; Pontiac Vibe 2003 - On

UNIT PACKAGE: 15



22058

(Ford: N807673-S)
Black Nylon

Tailgate Push-Type Retainer

Head Diameter: 14mm
Stem Length: 9mm
Fits into 7mm Hole
Ford Explorer Sport Trac 2010 - 2007

UNIT PACKAGE: 10



14697

(GM: 94198687;
Honda: 90657-SA6-0030;
Mazda: N304-13-356-A)
Black Nylon

Push-Type Retainer

Head Diameter: 14mm
Stem Length: 11mm
Fits into 7mm Hole

UNIT PACKAGE: 25



16816

(GM: 21047094, Chrysler: 6502632)
Black Nylon

Push-Type Retainer

Top Head Diameter: 14mm
Stem Length: 14mm
Fits into 6mm Hole
GM Saturn SC, SC1, SC2, SL1, SL2, SW1, SW2
1994 - 1991; Chrysler Pacifica 2017 - On;
Voyager 2020; Dodge Charger 2016 - 2015;
Durango 2003 - 2001;
Jeep Grand Cherokee 2014;
Ram 1500, 2500, 3500 2010 - On

UNIT PACKAGE: 25



21104

(90467-07190-B2)
Black Nylon

Interior Trim Push-Type Retainer

Head Diameter: 14mm
Stem Length: 14mm
Fits into 7mm Hole
Toyota Echo & Scion 2004 - On

UNIT PACKAGE: 10

PUSH-TYPE RETAINERS

Sec. 19

Refer to Retainer Specification Chart on pages 571-581

Listed smallest to largest by Head Diameter, Stem Length and then by Hole Diameter.



17478
(B101-68-252-00)
Black Nylon

Interior Trim Push-Type Retainer
Head Diameter: 14mm
Stem Length: 16mm
Fits into 6mm Hole
Ford Probe & Mazda MX6 1988 - On

UNIT PACKAGE: 25



16859
(Nissan: 66860-01W01;
GM: 94051993)
Black Nylon

**Cowl Panel to Reinforcement Plate &
Engine Splash Shield Push-Type Retainer**
Head Diameter: 14mm (9/16")
Stem Length: 16mm (5/8")
Fits into 6mm (1/4") Hole
Nissan 1980 - On
Geo Storm 1990 - On

UNIT PACKAGE: 25



25178
(Ford: W703243-S300)
Black Nylon

Cowl Vent Push-Type Retainer
Head Diameter: 14mm
Stem Diameter: 6.3mm
Stem Length: 18mm
Fit into 6.3mm Hole
Ford Transit Connect 150, 250, 350 2015 - On

UNIT PACKAGE: 10



22349
(Ford: W719367-S300)
Black Nylon

Push-Type Retainer
Head Diameter: 14mm
Stem Length: 18mm
Fits into 8mm x 11mm Hole
Ford

UNIT PACKAGE: 15



19337
(N808908-S)
Black Nylon

Headlight Accessory Push-Type Retainer
Head Diameter: 14mm
Stem Length: 23mm
Fits into 6.3mm (1/4") Hole
Ford Mustang 1996 - On

UNIT PACKAGE: 10



20943
(15014352)
Black Nylon

Cowl Vent Push-Type Retainer
Head Diameter: 14mm
Stem Length: 23mm
Fits into 7mm Hole
Buick Lucerne 2006 - On

UNIT PACKAGE: 15



18353
(15960325)
White Nylon

Door Trim Panel Push-Type Retainer
Head Diameter: 9/16" (14.3mm)
Stem Length: 41/64" (16.3mm)
Fits into 1/4" (6.4mm) Hole
GM Trucks C, K, 1, 2, 3 1995 - On

UNIT PACKAGE: 50



23738
(10116-41810)

Trim Push-Type Retainer
Head Diameter: 15mm
Stem Diameter: 7mm
Stem Length: 14mm
Toyota

UNIT PACKAGE: 25



21593
(46064AE000)
Black Nylon

**Front Fender, Bumper &
Quarter Panel Push-Type Retainer**
Head Diameter: 15mm
Stem Length: 8mm
Fits into 7mm Hole
Subaru Baja, Forester, Impreza,
Legacy & Outback 2003 - On

UNIT PACKAGE: 10



22859
(BMW: 16-13-6-753-087)
Black Nylon

**Cowl Grille & Fuel Tank Strap
Push-Type Retainer**
Head Diameter: 15mm
Stem Length: 8mm
Fits into 6.3mm Hole
BMW 320i, 328d, 328i, 328i GT, 330e, 330i, 330i GT, 335i,
335i GT, 340i, 340i GT, 428i, 428i Gran Coupe, 430i,
430i Gran Coupe, 435i, 440i &
440i Gran Coupe 2012 - On; Mini-Cooper 2015 - 2007

UNIT PACKAGE: 25

PUSH-TYPE RETAINERS

Refer to Retainer Specification Chart on pages 571-581

Listed smallest to largest by Head Diameter, Stem Length and then by Hole Diameter.



21990

(VW: 6L0-121-136A)
Black Nylon

Push-Type Retainer
Head Diameter: 15mm
Stem Length: 8mm
Fits into 7mm Hole
VW, Audi, SEAT & Skoda

UNIT PACKAGE: 15



21328

(86155-2H100)
Black Nylon

Cowl & Bumper Push-Type Retainer
Head Diameter: 15mm
Stem Length: 10mm
Fits into 7mm Hole
Hyundai Genesis & Veracruz
and Kia Rio 2009 - On

UNIT PACKAGE: 15



22160

(Subaru: 909140062)
Black Nylon

Front & Rear Bumper Push-Type Retainer
Head Diameter: 15mm
Stem Length: 10mm
Fits into 7mm Hole
Subaru BRZ, Forester, Impreza &
XV Crosstrek 2008 - On

UNIT PACKAGE: 15



19013

(90467-07059-22)
Black Nylon

Rear Door Trim & Luggage Compartment Door Push-Type Retainer
Head Diameter: 15mm
Stem Length: 10mm
Fits into 7mm Hole
Toyota Camry & Celica 1990 - On

UNIT PACKAGE: 15



22552

(GM: 9130754)
Black Nylon

Front Bumper Push-Type Retainer
Head Diameter: 16mm
Stem Length: 10mm
Fits into 6mm Hole
Cadillac Catera 2001 - 2000
Saturn Astra 2008

UNIT PACKAGE: 25



22280

(VW: 3C0-853-934)
Black Nylon

Splash Shield & Rocker Moulding Push-Type Retainer
Head Diameter: 15mm
Hex: 8mm (with 4mm Allen Drive)
Stem Length: 10mm
Fits into 8mm Hole
Volkswagen CC 2009 - On
Passat 2010 - 2006

UNIT PACKAGE: 25



22421

(VW: N10-700-901)
Black Nylon

Front Suspension Shield Push-Type Retainer
Head Diameter: 15mm
Stem Length: 11mm
Fits into 5mm Hole
Audi A3 & Q7 and Porsche 911 &
Cayenne and Volkswagen Golf, Jetta,
Passat, Eos & Phaeton 2009 - On

UNIT PACKAGE: 25



22367

(Honda: 91514-TR3-A01)
Black Nylon

Fender Liner Push-Type Retainer with Phillips Truss Head Stainless Steel Screw
Screw Head Diameter: 15.5mm
Nylon Grommet
Head Diameter: 15mm
Stem Length: 10mm
Fits into 9mm Square Hole
Honda Civic 2015 - 2014

UNIT PACKAGE: 5



14696

(Honda: 90684-SA5-0030;
Isuzu: 8942981190;
Nissan 10998-30880)
Black Nylon

Push-Type Retainer
Head Diameter: 15mm
Stem Length: 11mm
Fits into 6mm Hole

UNIT PACKAGE: 25



21658

(Mitsubishi: MR288150;
Subaru: 909130013)
Black Nylon

Push-Type Retainer
Head Diameter: 15mm
Stem Length: 11mm
Fits into 6mm Hole
Mitsubishi Endeavor, Galant, Lancer,
Mirage, Montero & Outlander 1997 - On
Subaru BRZ, Forester, Impreza, Legacy,
Outback, & XV Crosstrek 2004 - On

UNIT PACKAGE: 10



PUSH-TYPE RETAINERS

Refer to Retainer Specification Chart on pages 571-581

Listed smallest to largest by Head Diameter, Stem Length and then by Hole Diameter.



25335

(Mercedes: 000-991-92-40)
Black Nylon

Trim Panel Push-Type Retainer

Head Diameter: 15mm
Stem Length: 11.5mm
Stem Diameter: 5mm
Fits into 5mm Hole
Panel Range: 3mm-5mm
Mercedes AMG GT, S580 2021,
C230 2007 - 2003, C32 AMG 2004 - 2002,
C55 AMG 2006 - 2005,
C240, C320 2005 - 2001, C280, C350 2007 - 2006,
CLK350 2009 - 2006, CLK500 2006 - 2004,
CLK550 2009 - 2007, CLK63 AMG 2008, CLK320, CLK55
AMG 2005 - 2004, GLC300, Metris 2021 - 2016,
GLC350, S450, S560, S65 AMG 2020 - 2018,
GLC43 AMG 021 - 2017, GLC63 AMG 2021-2018,
S500 2021- 2014, S600 2017 - 2015,
S63 AMG 2020 - 2014, SL400 2016 - 2015,
SL450, SLC300, SLC43 AMG 2020 - 2017,
SL550 2020 - 2013, SL63 AMG 2019 - 2013,
SL65 AMG 2018 - 2013, SLK280 2008 - 2006,
SLK300 2011 - 2009, SLK350 2011 - 2005,
SLK55 AMG 2010 - 2005,
Sprinter 1500, 2500, 3500 2021 - 2019

UNIT PACKAGE: 25



14260

(Toyota: 90467-06017;
Mazda: 9926-50-625;
GM: 20426301)
Black Nylon

Push-Type Retainer

Head Diameter: 15mm
Stem Length: 12mm
Fits into 7mm Hole

UNIT PACKAGE: 15



20580

(MR478262)
Black Nylon

Bumper Cover & Garnish Moulding Push-Type Retainer

Top Head Diameter: 15mm
Bottom Head Diameter: 14mm
Stem Length: 12mm
Fits into 7mm Hole

Use with Auveco 20581

Chrysler Sebring & Stratus
and Mitsubishi Eclipse 2000 - On

UNIT PACKAGE: 15



22596

(BMW: 17-11-1-712-963)
Black Nylon

Bumper Side Support & Fan Shroud Push-Type Retainer

Head Diameter: 15mm
Stem Length: 11mm
Fits into 8mm Hole
BMW 3, 5, 7, 8, X, Z Series
& i8 1990 - On
Mini-Cooper 2010 - 2007

UNIT PACKAGE: 25



17206

(90467-09145)
Black Nylon

Bumper Cover Push-Type Retainer

Head Diameter: 15mm
Stem Length: 12mm (Excluding the Pin)
Fits into 9mm Hole
Toyota Camry 1992 - On

UNIT PACKAGE: 15



21140

(MB619582)
Black Nylon

Interior Trim, Bumper & Grille Push-Type Retainer

Head Diameter: 15mm
Stem Length: 12mm
Fits into 6.3mm Hole
Mitsubishi Eclipse, Endeavor,
Lancer & Outlander 2002 - On

UNIT PACKAGE: 25



20363

(Not Available from O.E.M.)
White Nylon

Door Trim Panel Push-Type Retainer

Top Head Diameter: 15mm
Bottom Head Diameter: 20mm
Stem Length: 12mm (Excluding the Pin)
Fits into 9mm Hole
Ford 2001 - On

UNIT PACKAGE: 25



22199

(Honda: 90657-SA5-003)
Black Nylon

Bumper & Splash Shield Push-Type Retainer

Head Diameter: 15mm
Stem Length: 12mm
Fits into 6.3mm Hole
Acura TL 2008 - 04
Honda Accord, CR-V, Insight
& Pilot 2007 - 1997

UNIT PACKAGE: 15



17162

(GM: 96057846;
Hyundai: 86155-22000
Toyota: 90467-07041)
Black Nylon

Push-Type Retainer

Head Diameter: 15mm
Stem Length (Excluding Pin): 8mm
Fits into 6.3mm Hole
Geo Metro & Tracker, Hyundai
and Toyota 1989 - On

UNIT PACKAGE: 10

PUSH-TYPE RETAINERS

Refer to Retainer Specification Chart on pages 571-581

Listed smallest to largest by Head Diameter, Stem Length and then by Hole Diameter.



19311
(90683-SA5-003)
Black Nylon

Front Fender Skirt Push-Type Retainer

Head Diameter: 15mm
Stem Length: 13mm
Fits into 6mm Hole
Honda Prelude 1996 - 1992

UNIT PACKAGE: 15



19142
(91550-SH3-003)
Black Nylon

Pillar Garnish, Side and Trunk Lining Push-Type Retainer

Head Diameter: 15mm
Stem Length: 13mm
Fits into 7mm Square Hole
Honda Civic, Accord Wagon
& Del Sol 1993 - On

UNIT PACKAGE: 5



20169
(W701971-S)
White Nylon

Door Trim Panel Push-Type Retainer

Head Diameter: 15mm
Stem Length: 13mm
Fits into 7mm Hole
Lincoln LS 2000 - On

UNIT PACKAGE: 25



21620
(01553-06071)
Black Nylon

Rear Duct Finishing Panel Push-Type Retainer

Head Diameter: 15mm
Stem Length: 14mm
Fits into 5mm Hole
Nissan Cube S, SL,
Krom & Leaf 2012 - On

UNIT PACKAGE: 15



23822
(B040-68-865-A96, 94530438)
Black Nylon

Interior Trim, Cowl, Fender & Bumper Push-Type Retainer

Hole: M6
Head Diameter: 15mm
Stem Length: 14mm
Ford Probe 1988; Mazda M6 1988 - On;
Chevrolet Aveo 2004 - On

UNIT PACKAGE: 25



21112
(94530438)
Black Nylon

Fender Liner Push-Type Retainer

Head Diameter: 15mm
Stem Length: 14mm
Fits into 6mm Hole
Chevrolet Aveo 2004 - On

UNIT PACKAGE: 25



21120
(90467-07192)
Black Nylon

Cowl Vent Push-Type Retainer

Head Diameter: 15mm
Stem Length: 14mm
Fits into 7mm Hole
Toyota RAV 4 2002 - On

UNIT PACKAGE: 15



20234
(BMW: 51-11-1-908-077;
Mercedes: 00-990-54-92)
Black Nylon

Scuff Plate Push-Type Retainer

Head Diameter: 15mm
Stem Length: 15mm
Fits into 6.3mm Hole
BMW Series 3, 5 & 7 1984 - On
Mercedes 2014 - 1994

UNIT PACKAGE: 50



21645
(Not Available from O.E.M.)
Black Nylon

Bumper & Wheel Opening Push-Type Retainer

Head Diameter: 15mm
Stem Length: 15mm
Fits into 6.3mm Hole
BMW 2004 - On

UNIT PACKAGE: 15



11705
(387843-S)
Black Nylon

Fender Shield Retainer

Head Diameter: 19/32" (15mm)
Stem Length: 5/8" (16mm)
Fits into 1/4" (6.4mm) Hole
Ford 1978 - On

UNIT PACKAGE: 50

PUSH-TYPE RETAINERS

Refer to Retainer Specification Chart on pages 571-581

Listed smallest to largest by Head Diameter, Stem Length and then by Hole Diameter.



21011

(90467-07188)
Black Nylon

Push-Type Retainer

Head Diameter: 15mm
Stem Length: 17mm
Fits into 7mm Hole
Toyota Camry, Tundra & 4-Runner
2002 - On

UNIT PACKAGE: 15



22401

(BMW: 51-11-1-964-186)
Black Nylon

**Bumper Cover
Push-Type Retainer**

Head Diameter: 15mm
Stem Length: 20mm
Fits into 6mm Hole
BMW 3, 5, 7, X
Z Series 2010 - 1983

UNIT PACKAGE: 25



19801

(21077123)
Black Nylon

**Wheel Opening Moulding
Push-Type Retainer**

Head Diameter: 19/32" (15mm)
Stem Length: 3/4" (19mm)
Fits into 1/4" (6.4mm) Hole
Saturn 1991 - On

UNIT PACKAGE: 25



23958

(90467-07193)
Black Nylon

Cowl Vent Push-Type Retainer

Head Diameter: 15mm
Stem Length: 20mm
Fits into 7mm Hole
Toyota RAV4 2002

UNIT PACKAGE: 15



17222

(GM: 21075686;
Ford: F3LY-14570-B)
Black Nylon

**Rocker Panel, Wheel Liner &
Air Inlet Duct Push-Type Retainer**

Head Diameter: 15mm
Stem Length: 20mm
Fits into 8mm Hole
GM Saturn 2 Door &
4 Door Models 1991 - On
Ford

UNIT PACKAGE: 25



22347

(GM: 11561878)
Black Nylon

**Bumper, Fender Liner, Cowl, Grille,
Air Inlet Duct, Rocker Panel, Wheel Liner,
Quarter Panel & Upper Deflector
Push-Type Retainer with Sealer**

Head Diameter: 15mm
Stem Length: 21mm
Fits into 8mm Hole
Various Buick, Cadillac Chevrolet,
GMC, Hummer, Saab &
Saturn Models 1991 - On

UNIT PACKAGE: 25

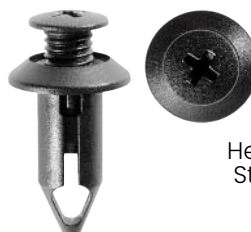

14997

(10053182)
Black Nylon

Push-Type Retainer

Head Diameter: 19/32" (15mm)
Stem Length: 13/16" (20.6mm)
Fits into 5/16" (8mm) Hole
GM 1987 - On

UNIT PACKAGE: 25



17103

(GM: 15681408;
Ford: N803709S)
Black Nylon

Fascia Retainer

Head Diameter: 15mm
Stem Length: 23mm
Fits into 6mm Hole
GM & Ford 1986 - On

UNIT PACKAGE: 50



14992

(Ford: N803946S;
Chry: 650287i;
Mercedes: 000-991-52-40)
Black Nylon

Door Panel Push-Type Retainer

Head Diameter: 19/32"
Stem Length: 29/32"
Fits into 1/4" Hole
Ford & Chrysler 1987 - On;
Mercedes Metris 2020 - 2016; Sprinter
1500, 2500, 3500 2019 - On

UNIT PACKAGE: 50



19511

(W704958-S300)
White Nylon

**Rear Door Lower Trim Panel
Push-Type Retainer**

Round Head Diameter: 19/32" (15mm)
Wedge Shaped Head
Diameter: 29/32" (23mm)
Stem Length: 11/16" (17.5mm)
Fits into 3/8" (9.5mm)
Lincoln Town Car 1998 - On

UNIT PACKAGE: 25

PUSH-TYPE RETAINERS

Refer to Retainer Specification Chart on pages 571-581

Listed smallest to largest by Head Diameter, Stem Length and then by Hole Diameter.



17439
(90467-09093)
Black Nylon

Bumper Cover Push-Type Retainer
Head Diameter: 15mm
Stem Length: 27mm
Fits into 9mm Hole
Lexus LS-400

UNIT PACKAGE: 10



19219
(90467-09096)
Black Nylon

Front Bumper Push-Type Retainer
Head Diameter: 15mm
Stem Length: 27mm
Fits into 9mm Hole
Lexus LS400 and Toyota Celica & Supra 1989 - On

UNIT PACKAGE: 10



17226
(10207146, 21077323)
Black Nylon

Rear Door Rocker Panel to Underbody Bracket Push-Type Retainer
Head Diameter: 15mm
Stem Length: 29mm
Fits into 8mm Hole
GM Saturn 4 Door Models 1991 - On

UNIT PACKAGE: 25



22855
(BMW: 51-49-8-237-075)
Dark Gray Nylon

Trunk Lid, Quarter Trim & Control Module Push-Type Retainer
Head Diameter: 15.5mm
Stem Length: 13mm
Fits into 8mm Hole
BMW 128i, 135i, 323i, 325Ci, 325i, 325xi, 328i, 328xi, 330Ci, 330i, 330xi, 335d, 335i, 335is, 335xi, M3, X3, & X4 2018 - 1999
Mini-Cooper 2007 - On

UNIT PACKAGE: 25



19552
(90467-07146)
Black Nylon

Cowl Panel & Luggage Compartment Retainer
Head Diameter: 16mm
Stem Length: 9mm
Fits into 7mm Hole

Toyota Avalon, Camry, Celica & Solara 1993 - On

UNIT PACKAGE: 15



21624
(90467-10206)
Black Nylon

Cowl Push-Type Retainer
Head Diameter: 16mm
Stem Length: 10mm
Fits into 8mm Hole

Lexus ES 350, RX350 & RX 450H and Toyota Camry, Sequoia, Tundra & Yaris 2006 - On

UNIT PACKAGE: 15



22083
(Suzuki: 09409-08327)
Black Nylon

Front Lights, Cowl & Rear Bumper Push-Type Retainer
Head Diameter: 16mm
Stem Length: 10mm
Fits into 8mm Hole

Suzuki Kizashi, SX4 & XL7 2013 - 2002

UNIT PACKAGE: 15



21570
(909140012)
Black Nylon

Rear Light Reflector & Roof Spoiler Push-Type Retainer
Head Diameter: 16mm
Stem Length: 11mm
Fits into 6mm Hole
Subaru B9 Tribeca, Impreza, Legacy & Outback 2005 - On

UNIT PACKAGE: 25



21044
(123-990-05-92, 126-990-03-92)
Black Nylon

Cowl Screen Cover Push-Type Retainer
Head Diameter: 16mm
Stem Length: 11mm
Fits into 6.3mm Hole
Mercedes-Benz E, CL & S Class 2000 - On

UNIT PACKAGE: 15



20310
(383142-S)
Black Nylon

Grille to Headlight Bracket Push-Type Retainer
Head Diameter: 5/8" (16mm)
Stem Length: 7/16" (11mm)
Fits into 1/4" (6.4mm) Hole
Ford

UNIT PACKAGE: 50

PUSH-TYPE RETAINERS

Refer to Retainer Specification Chart on pages 571-581

Listed smallest to largest by Head Diameter, Stem Length and then by Hole Diameter.



19306

(GA5R-56-392)
Black Nylon

Shroud Seal Board Push-Type Retainer

Head Diameter: 16mm
Stem Length: 12mm
Fits into 6mm Hole
Mazda 626 1994 - On
UNIT PACKAGE: 10



19297

(21035345)
Black Nylon

Liftgate Upper Window & Lower Garnish Moulding Push-Type Retainer

Head Diameter: 16mm
Stem Length: 12mm (Excluding the Pin)
Fits into 7mm Hole
GM Saturn 1998 - 1993
UNIT PACKAGE: 15



19195

(161-867-299-01C)
Black Nylon

Push-Type Retainer

Head Diameter: 16mm
Stem Length: 12mm
Fits into 8mm Hole
VW Golf & Jetta 1997 - 1993
UNIT PACKAGE: 25



19607

(XL3Z-17E971-AA)
Natural Nylon

Front Bumper Cover Push-Type Retainer

Head Diameter: 16mm
Stem Length: 12mm
Fits into 10mm Hole
Ford F150 & F250 Trucks 1999 - On
UNIT PACKAGE: 25



22420

(Audi: 8K0-868-307)
Black Nylon

Fender End Plate Push-Type Retainer

Head Diameter: 16mm
Stem Length: 12mm
Fits into 10.5mm Hole
Audi A4 allroad, A5, A7, Q7, RS5,
RS7, S5 & S7 2009 - On

UNIT PACKAGE: 25



21566

(91085TA030)
Black Nylon

Push-Type Retainer

Head Diameter: 16mm
Stem Length: 13mm
Fits into 7mm Hole
Subaru Baja, Impreza, Legacy & Outback 2000 - On
UNIT PACKAGE: 25



22177

(Chrysler: 6510766-AA)
Yellow & White Nylon

Door Panel Push-Type Retainer with Sealer

Top Head Diameter: 16mm
Middle Head Diameter: 18mm
Bottom Head Diameter: 22mm
Stem Length: 13mm
Fits into 9mm Hole
Chrysler 300, Dodge Charger &
Jeep Cherokee 2014 - On

UNIT PACKAGE: 15



21601

(6509673AA, 68185909AA)
White Nylon with Black Rubber Seal

Push-Type Retainer

Top Head Diameter: 16mm
Middle Head Diameter: 18mm
Bottom Head Diameter: 22mm
Stem Length: 16mm
Fits into 9mm Hole
Chrysler 200, 300 & Challenger and Dodge
Durango & Viper and Jeep Cherokee,
Grand Cherokee & Wrangler 2011 - On

UNIT PACKAGE: 15



15522

(N805231S)
Black Nylon

Push-Type Retainer

Head Diameter: 5/8" (16mm)
Stem Length: 17/32" (13.5mm)
Fits into 1/4" (6.4mm) Hole
Ford Taurus, Topaz & Sable 1989 - On

UNIT PACKAGE: 50



19248

(1268176-3)
Black Nylon

Bumper Cover Push-Type Retainer

Head Diameter: 16mm
Stem Length: 14mm
Fits into 6mm Hole
Volvo 740 & 760 1993 - On

UNIT PACKAGE: 15



22759

(VW: 5K0-837-975A)
Natural Nylon

Window Regulator Push-Type Retainer

Head Diameter: 16mm
Stem Length: 14mm
Fits into 7mm Hole
Volkswagen GTI, Golf
& Golf R 2014 - 2010

UNIT PACKAGE: 15

PUSH-TYPE RETAINERS

Refer to Retainer Specification Chart on pages 571-581

Listed smallest to largest by Head Diameter, Stem Length and then by Hole Diameter.



21190

(91550-S50-000ZL)
Black Nylon

Interior Trim Push-Type Retainer

Head Diameter: 16mm
Stem Length: 14mm
Fits into 7mm Hole
Honda Civic, CR-V Element
& Insight 2000 - On

UNIT PACKAGE: 15



21477

(91550-S50-000ZK)
Gray Nylon

Push-Type Retainer

Head Diameter: 16mm
Stem Length: 14mm
Fits into 7mm Hole
Honda Civic, CR-V Element & Insight 2000 - On

UNIT PACKAGE: 15



21325

(90080-46294)
Black Nylon

Turn Signal Light & General Purpose Push-Type Retainer

Head Diameter: 16mm
Stem Length: 14mm
Fits into 7mm Hole
Toyota Tundra 2003 - On

UNIT PACKAGE: 10



19904

(9133417-7)
Black Nylon

Rocker Panel Push-Type Retainer

Head Diameter: 16mm
Stem Length: 14mm
Fits into 9mm Hole
Volvo 850 Series 1994 - On

UNIT PACKAGE: 15



20909

(124-990-04-92)
Black Nylon

Push-Type Retainer

Head Diameter: 16mm
Stem Length: 18mm
Fits into 7mm Hole
Mercedes-Benz 2003 - On

UNIT PACKAGE: 15



18265

(76882-57A00)
Black Nylon

Body Side Moulding Push-Type Retainer

Head Diameter: 16mm
Stem Length: 20mm
Fits into 8mm Hole
Nissan Sentra 1986 - On

UNIT PACKAGE: 25



20352

(Honda: 91561-S84-A00-M1,
91561-S84-A21ZB)
Black Nylon

Rear Panel Assembly Push-Type Retainer

Head Diameter: 16mm
Stem Length: 21mm
Fits into 8mm Hole
Honda Accord & Civic 2007 - 2001
Fit 2014 - 2009

UNIT PACKAGE: 10



20542

(15994165)
Black Nylon

Bumper & Rear Wheel Apron Push-Type Retainer

Head Diameter: 16.5mm
Stem Length: 27mm
Fits into 8mm Hole
Saturn L Series 2000 - On

UNIT PACKAGE: 25



14011

(14019226, 14071289)
Black Nylon

Radiator Overflow Bottle/Windshield Washer Bottle Retainer

Head Diameter: 21/32" (16.7mm)
Stem Length: 9/16" (14.3mm)
Fits into 5/16" (8mm) Hole
GM 1981 - On

UNIT PACKAGE: 25



14001

(14039420)
Black Nylon

Push-Type Retainer

Head Diameter: 21/32" (16.7mm)
Stem Length: 19/32" (15mm)
Fits into 5/16" (8mm) Hole
GM (Including Saturn)

UNIT PACKAGE: 25

PUSH-TYPE RETAINERS

Refer to Retainer Specification Chart on pages 571-581

Listed smallest to largest by Head Diameter, Stem Length and then by Hole Diameter.



18270

(90467-07117)
Black Nylon

Push-Type Retainer
Head Diameter: 17mm
Stem Length: 9mm
Fits into 7mm Hole
Lexus 1990 - On

UNIT PACKAGE: 10



15672

(8880417)
Black Nylon

Push-Type Retainer
Head Diameter: 17mm
Stem Length: 14mm
Fits into 8mm (5/16") Hole
Chrysler 1987 - On

UNIT PACKAGE: 25



18165

(91508-SR3-000)
Black Nylon

**Cowl Panel
Push-Type Retainer**
Head Diameter: 17mm
Stem Length: 9mm
Fits into 8mm Hole
Honda 1990 - On

UNIT PACKAGE: 10



19546

(91570-SK7-003ZF)
Black Nylon

Tailgate Lining Retainer
Head Diameter: 17mm
Stem Length: 16mm
Fits into 7mm Square Hole
Honda Prelude 1997 - On

UNIT PACKAGE: 10



17351

(MB-253964)
Black Nylon

**Front & Rear Bumper
Push-Type Retainer**
Head Diameter: 17mm
Stem Length: 10mm
Fits into 7mm Hole
Mitsubishi Tredia 1988 - 1983

UNIT PACKAGE: 10



19639

(GM: 15149708;
Chrysler: 6506008AA)
Black Nylon

**Radiator Wheelhouse, Fender &
Front Bumper Cover Push-Type Retainer**
Head Diameter: 17mm
Stem Length: 16mm
Fits into 6mm Hole
GM C & K Trucks 1999 - On
Jeep Liberty 2002 - On

UNIT PACKAGE: 25



19232

(91502-SZ5-003)
Black Nylon

**Front Fender
Push-Type Retainer**
Head Diameter: 17mm
Stem Length: 13mm
Fits into 7mm Hole
Acura 3.5 RL Sedan 1996 - On

UNIT PACKAGE: 10



16624

(1636632, 20687704)
Black Nylon

**Front Bumper Fascia
Push-Type Retainer**
Head Diameter: 17mm
Shoulder Length: 2mm
Stem Length: 18mm
Fits into 9.5mm (3/8") Hole
Buick Riviera/Reatta 1988 - On

UNIT PACKAGE: 25



19547

(91508-S50-003)
Black Nylon

Cowl Top Retainer
Head Diameter: 17mm
Stem Length: 13mm (Excluding the Pin)
Fits into 9mm Hole
Honda Accord & Odyssey 1998 - On

UNIT PACKAGE: 5



14726

(63844-01A99)
Black Nylon

Push-Type Retainer
Head Diameter: 17mm
Stem Length: 18mm
Fits into 8mm Hole
Nissan

UNIT PACKAGE: 25

PUSH-TYPE RETAINERS

Refer to Retainer Specification Chart on pages 571-581

Listed smallest to largest by Head Diameter, Stem Length and then by Hole Diameter.



13457
(20451119)
Black Nylon

Front Compartment Spare Tire Retainer
Head Diameter: 43/64" (17mm)
Stem Length: 23/32" (18.3mm)
Fits into 5/16" (8mm) Hole
GM

UNIT PACKAGE: 10



11704
(6031383)
Black Nylon

Grille Retainer
Head Diameter: 11/16" (17.5mm)
Stem Length: 7/16" (11mm)
Fits into 9/32" (7.1mm) Hole
Chrysler 1978 - On

UNIT PACKAGE: 25



23826
(22538004)
Black Nylon

Grille to Headlamp Housing Push-Type Retainer
Hole: M6.3
Stem Length: 22mm
Flange: 17mm
GM, Pontiac, Olds "J" Body 1989 - On

UNIT PACKAGE: 25



12567
(GM: 14019205, 14019206, 16514113;
Chrysler: 34201621, 6504090)
Black Nylon

Front Fender Mud Skirt & Fender Liner Push-Type Retainer
Head Diameter: 11/16" (17.5mm)
Stem Length: 9/16" (14.3mm)
Fits into 1/4" (6.4mm) Hole
GM 1981 - On

UNIT PACKAGE: 25

14007

Same as 12567 except unit package quantity

UNIT PACKAGE: 50



18893
(N806322-S)
Black Nylon

Trim Panel Push-Type Retainer
Head Diameter: 11/16" (17.5mm)
Stem Length: 1/2" (12.7mm)
Fits into 1/4" (6.4mm) Hole
Ford

UNIT PACKAGE: 15



11699
(GM: 472434; Chrysler: 6031390)
Black Nylon

Cowl Ledge Weatherstrip & Fender Liner Push-Type Retainer
Head Diameter: 11/16" (17.5mm)
Stem Length: 5/8" (16mm)
Fits into 1/4" (6.4mm)
GM 1970 - On
Chrysler 1968 - On

UNIT PACKAGE: 50



18327
(6503454)
Black Nylon

Front Bumper Fascia Push-Type Retainer
Head Diameter: 11/16" (17.5mm)
Stem Length: 5/8" (16mm)
Fits into 1/4" (6.4mm) Hole
Jeep Grand Cherokee 1994 - On

UNIT PACKAGE: 25



14991
(GM: 10139822, 25680782;
Ford: N808147S)
Black Nylon

Push-Type Retainer
Head Diameter: 11/16" (17.5mm)
Stem Length: 11/16" (17.5mm)
Fits into 1/4" (6.4mm) Hole
GM & Ford 1987 - On

UNIT PACKAGE: 25



18894
(N807578-S, N808332-S)
Black Nylon

Trim Panel Push-Type Retainer
Head Diameter: 11/16" (17.5mm)
Stem Length: 3/4" (19mm)
Fits into 1/4" (6.4mm) Hole
Ford

UNIT PACKAGE: 15



18030
(Chrysler: 6501925;
GM: 10134407)
Black Nylon

Push-Type Retainer
Head Diameter: 11/16" (17.5mm)
Stem Length: 13/16" (20.6mm)
Fits into 1/4" (6.4mm) Hole
Chrysler Concorde & LHS
Dodge Intrepid & Eagle Vision 1993 - On
GM 1992 - On

UNIT PACKAGE: 25

PUSH-TYPE RETAINERS

Refer to Retainer Specification Chart on pages 571-581

Listed smallest to largest by Head Diameter, Stem Length and then by Hole Diameter.



13993

(GM: 20510029; Ford: N803362-S;
Chrysler: 34202672)
Black Nylon

Body Retainer

Head Diameter: 11/16" (17.5mm)
Stem Length: 7/8" (22mm)
Fits into 1/4" (6.4mm) Hole
GM 1984 - On & Ford 1984 - On

UNIT PACKAGE: 25



23954

(16514113)
Black Nylon

Front Lamp Mounting & Pivots Push-Type Retainer

Hole: M6.35
Flange: 17.8mm
Stem Length: 14.2mm
GM Cars & Trucks 1988 - On

UNIT PACKAGE: 25



14753

(GM: 15773445, 20452072, 20664092;
Ford N804570S; Chrysler: 4638136)
Black Nylon

Radiator Shroud & Trim Retainer

Head Diameter: 11/16" (17.5mm)
Stem Length: 7/8" (22mm)
Fits into 1/4" (6.4mm) Hole
GM 1982 - On; Ford 1986 - On
Chrysler 1998 - On

UNIT PACKAGE: 25



20335

(53879-60010)
Black Nylon

Fender Liner Push-Type Retainer

Head Diameter: 18mm
Stem Length: 7mm
Fits into 7mm Hole
Toyota Land Cruiser & RAV 4 1998 - On

UNIT PACKAGE: 15



14993

(22538004)
Black Nylon

Push-Type Retainer

Head Diameter: 11/16" (17.5mm)
Stem Length: 7/8" (22mm)
Fits into 1/4" (6.4mm) Hole
GM 1987 - On

UNIT PACKAGE: 25



20869

(GM: 88970767; Toyota: 90467-10183)
Black Nylon

Front Fender Liner Push-Type Retainer

Head Diameter: 18mm
Stem Length: 7.5mm
Fits into 7mm Hole
Toyota Celica, Corolla, Matrix & Solara,
Lexus and Pontiac Vibe 1999 - On

UNIT PACKAGE: 10



13996

(20452072, 20590899)
Black Nylon

Exterior Body Retainer

Head Diameter: 11/16" (17.5mm)
Stem Length: 7/8" (22mm)
Fits into 9/32" (7.1mm) Hole
GM 1984 - On

UNIT PACKAGE: 25



19490

(90467-06150)
Black Nylon

Back Garnish Trim Panel Push-Type Retainer

Head Diameter: 18mm
Stem Length: 8mm
Fits into 6mm Hole
Toyota Tacoma 1995 - On

UNIT PACKAGE: 10



18895

(N807577-S, N808331-S)
Black Nylon

Trim Panel Push-Type Retainer

Head Diameter: 11/16" (17.5mm)
Stem Length: 1-3/32" (28mm)
Fits into 1/4" (6.4mm) Hole
Ford Aerostar & Windstar

UNIT PACKAGE: 15



20465

(UB39-45-919)
Black Nylon

Front & Rear Fender Push-Type Retainer

Head Diameter: 18mm
Stem Length: 9mm
Fits into 8mm Hole
Mazda 626 2000 - On

UNIT PACKAGE: 10

PUSH-TYPE RETAINERS

Refer to Retainer Specification Chart on pages 571-581

Listed smallest to largest by Head Diameter, Stem Length and then by Hole Diameter.



22781
(BMW: 07-14-7-213-303)
Natural Nylon

Rocker Moulding Push-Type Retainer
Head Diameter: 18mm
Stem Length: 9mm
Fits into 8mm Hole
BMW 530e, 530i, 540i, 640i, 640i
Gran Coupe, 650i, 650i Gran Coupe,
740e, 740i, 750i & M6 2018 - On

UNIT PACKAGE: 25



22077
(Mitsubishi: MB879499)
Black Nylon

Front Bumper Push-Type Retainer
Head Diameter: 18mm
Stem Length: 9mm
Fits into 9mm Hole
Mitsubishi Montero 2006 - 2001

UNIT PACKAGE: 25



22828
(VW: WHT-005-263)
Black Nylon

Bumper Diffuser Push-Type Retainer
Head Size: 18mm x 25mm
Stem Length: 9mm
T15 Torx® Drive
Fits into 8mm Slot
Volkswagen e-Golf, GTI, Golf, Golf
Alltrack & Passat 2017 - 2012

UNIT PACKAGE: 15



23943
(90467-07085)
Gray Nylon

Door Panel Push-Type Retainer
Head Diameter: 18mm
Stem Length: 9mm
Fits into 6.3mm Hole
Toyota Camry, RAV4,
4 Runner & Tacoma 1995 - On

UNIT PACKAGE: 25



21024
(5R3Z-54310D12-AAA)
Black Nylon

Trim Panel Push-Type Retainer
Head Diameter: 18mm
Stem Length: 10mm
Fits into 6mm Hole
Ford Mustang 2005 - On

UNIT PACKAGE: 15



21530
(Subaru: 909130067;
Hyundai: 86590-3S000)
Black Nylon

Engine Cover and Fender Liner Push-Type Retainer
Head Diameter: 18mm
Stem Length: 10mm
Fits into 8mm Hole
B9 Tribeca, Forester, Legacy & Outback &
Tribeca. 2005 - On; Hyundai Azera, Elantra, Genesis &
Sonata and Kia Cadenza & Optima 2011 - On

UNIT PACKAGE: 15



22595
(Hyundai: 86590-1W000)
Black Nylon

Bumper Cover Push-Type Retainer
Head Diameter: 18mm
Stem Length: 11mm
Fits into 8mm Hole
Hyundai Equus & Genesis 2016 - 2014
Kia Rio & Sedona 2012 - On

UNIT PACKAGE: 25



22181
(Subaru: 909140065)
Black Nylon

Front Fender Liner, Engine Cover, Hood & Quarter Panel Push-Type Retainer
Head Diameter: 18mm
Stem Length: 10mm
Fits into 8mm Hole
Subaru BRZ, Crosstrek, Forester, Impreza,
Legacy, Outback & WRX 2008 - On

UNIT PACKAGE: 15



21680
(Chrysler: 6509960AA)
Black Nylon

Bumper Push-Type Retainer
Head Diameter: 18mm
Stem Length: 10mm
Fits into 8mm Hole
Chrysler 300 2011 - On

UNIT PACKAGE: 25



19747
(UB39-50-795)
Black Nylon

Stone Guard Push-Type Retainer
Head Diameter: 18mm
Stem Length: 10mm
Fits into 8mm Hole
Mazda MPV 1998 - On

UNIT PACKAGE: 10

PUSH-TYPE RETAINERS

Sec. 19

Refer to Retainer Specification Chart on pages 571-581

Listed smallest to largest by Head Diameter, Stem Length and then by Hole Diameter.



21547

(90467-09185)
Black Nylon

**Front Spoiler & Grille
Push-Type Retainer**

Head Diameter: 18mm
Stem Length: 10mm
Fits into 9mm Hole
Lexus HS 250h and Toyota Celica, Sequoia,
Sienna & 4-Runner 1994 - On

UNIT PACKAGE: 25



14698

(90688-SB0-003)
Black Nylon

Push-Type Retainer

Head Diameter: 18mm
Stem Length: 11mm
Fits into 6mm Hole
Acura & Honda

UNIT PACKAGE: 25



16784

(Nissan: 80999-05N07;
Toyota: 90467-07043)
Black Nylon

Push-Type Retainer

Head Diameter: 18mm
Stem Length: 11mm (Excluding the Pin)
Fits into 7mm Hole

UNIT PACKAGE: 25



17081

(91524-SE0-003)
Black Nylon

Cowl Push-Type Retainer

Head Diameter: 18mm
Stem Length: 12mm
Fits into 6mm Hole
Honda Accord 1986 - On

UNIT PACKAGE: 25



18206

(GJ21-68885-B69)
Gray Nylon

Push-Type Retainer

Head Diameter: 18mm
Stem Length: 12mm
Fits into 6mm Hole
Ford Probe & MX6 1989 - On

UNIT PACKAGE: 25



21703

(Ford: W716510-S300)
Black Nylon

**Lower Radiator Shield
Push-Type Retainer**

Head Diameter: 18mm
Stem Length: 12mm
Fits into 7mm Hole
Ford Fusion 2013 - On

UNIT PACKAGE: 10



17632

(Mazda: B092-51-833;
Ford: MB-455-56143)
Black Nylon

Push-Type Retainer

Head Diameter: 18mm
Stem Length: 12mm
Fits into 8mm Hole
Mazda & Ford Aspire
UNIT PACKAGE: 10



21146

(0G032-50037-A)
Black Nylon

**Bumper, Fender, Grille, Interior & Exterior
Trim and Pillar Push-Type Retainer**

Head Diameter: 18mm
Stem Length: 12mm
Fits into 8mm Hole
Kia Amanti, Magentis, Optima, Rio, Sedona, Sephia,
Sorento, Spectra & Sportage 2000 - On
UNIT PACKAGE: 15



21311

(01553-0038U)
Gray Nylon

Bumper Push-Type Retainer

Head Diameter: 18mm
Stem Length: 12mm
Fits into 8mm Hole
Nissan Frontier, Pathfinder &
Xterra 2005 - On
UNIT PACKAGE: 10



20349

(Nissan: 01553-09611; Toyota: 90467-08185)
Black Nylon

**Bumper Clip
Push-Type Retainer**

Head Diameter: 18mm
Stem Length: 12mm
Fits into 8mm Hole
Nissan Maxima 1994 - On
UNIT PACKAGE: 15



21110

(B100-68-8550)
Black Nylon

**Rear Light Access Door
Push-Type Retainer**

Head Diameter: 18mm
Stem Length: 12mm
Fits into 8.5mm Hole
Mazda 323 1986 - On
UNIT PACKAGE: 15



20247

(Mitsubishi: MR200300)
Black Nylon

Fender & Bumper Push-Type Retainer

Head Diameter: 18mm
Stem Length: 12mm
Fits into 9mm Hole
Honda & Mitsubishi 1998 - On
UNIT PACKAGE: 15

PUSH-TYPE RETAINERS

Refer to Retainer Specification Chart on pages 571-581

Listed smallest to largest by Head Diameter, Stem Length and then by Hole Diameter.



21702
 (Toyota: 90467-10170-C0)
 Black Nylon
Cowl Vent, Upper Radiator Cover & Wheel Apron Push-Type Retainer
 Head Diameter: 18mm
 Stem Length: 12mm
 Fits into 10mm Hole
 Lexus LS 460, LS 600, RX 350 & RX 450 and Toyota RAV4 2006 - On

UNIT PACKAGE: 10



20365
 (10301966, 10425306)
 Black Nylon
Cowl Vent Push-Type Retainer
 Head Diameter: 18mm
 Stem Length: 13mm
 Fits into 7.5mm Square Hole
 Pontiac Aztek 2001 - On

UNIT PACKAGE: 10



22482
 (Honda: 91514-TF0-003)
 Black Nylon
Rocker Moulding Push-Type Retainer
 Head Diameter: 18mm
 Stem Length: 13mm
 Fits into 9mm x 9mm Square Hole
 Honda Accord, Fit & Fit EV 2009 - On

UNIT PACKAGE: 25



22394
 (Honda: 91561-TA0-A11, 91561-TA5-A11)
 Metal & Green Nylon
Interior Trim, Pillars, Rocker Panel, Quarter Panel & Windshield Push-Type Retainer
 Head Diameter: 18mm
 Stem Length: 13mm
 Overall Length: 38mm
 Fits into 9mm Hole
 Acura TL and Honda Accord, Civic, CR-Z, Fit, Odyssey, Pilot & Ridgeline 2008 - On

UNIT PACKAGE: 5



21141
 (91561-SJD-003)
 Black & White Nylon
Pillar, Rocker Panel & Floor Retainer
 Top Head Diameter: 15mm
 Middle Head Diameter: 16mm
 Bottom Head Diameter: 18mm
 Stem Length: 13mm
 Fits into 8mm Hole
 Honda Civic 2006 - On, Clarity 2017 - On, CR-V 2020 - 2012, Fit 2008 - 2007, Pilot 2004 - On

UNIT PACKAGE: 10



22829
 (VW: N-911-829-01)
 Black Nylon
Rocker Moulding Push-Type Retainer
 Head Diameter: 18mm
 Stem Length: 13mm
 Fits into 10mm Hole
 Volkswagen 2000 - On

UNIT PACKAGE: 15



21858
 (Mazda: B467-68-AC3-02)
 Black Nylon
Rear Trunk Liner Push-Type Retainer
 Head Diameter: 18mm
 Stem Length: 14mm
 Fits into 6mm Hole
 5, CX-7, CX-9, Miata, Millenia, MX-6, RX-7 & Protégé 1993 - On

UNIT PACKAGE: 25



21225
 (53888-48010)
 Black Nylon
Wheel Opening Push-Type Retainer
 Head Diameter: 18mm
 Stem Length: 14mm
 Fits into 7mm Hole
 Toyota Highlander 2001 - On

UNIT PACKAGE: 5



17192
 (91508-SM4-003)
 Black Nylon
Cowl Panel Push-Type Retainer
 Head Diameter: 18mm
 Stem Length: 14mm
 Fits into 8mm Hole
 Honda Accord 1990 - On

UNIT PACKAGE: 10



22253
 (Hyundai: 86595-2T500, 14206-08250-B)
 Black Nylon
Bumper, Engine Under Cover & Fender Liner Push-Type Retainer
 Head Diameter: 18mm
 Stem Length: 14mm
 Fits into 8mm Hole
 Hyundai Elantra, Equus, Genesis, Santa Fe & Sonata and Kia Forte, K900, Optima, Sedona & Sorento 2013 - On

UNIT PACKAGE: 15

PUSH-TYPE RETAINERS

Sec. 19

Refer to Retainer Specification Chart on pages 571-581

Listed smallest to largest by Head Diameter, Stem Length and then by Hole Diameter.



19453

(Honda: 90505-SX0-003
Tesla: 1006535-00-A)
Black Nylon

**Garnish Side Protector, Front Bumper,
Wheel Apron, Engine Under Cover
Push-Type Retainer**

Head Diameter: 18mm
Stem Length: 15mm (Excluding the Pin)
Fits into 8mm Hole
Honda Odyssey 1995 - On
Tesla S 2016 - On

UNIT PACKAGE: 15



19416

(Toyota: 90467-09139)
Black Nylon

**Bumper Cover & Wheel Housing
Push-Type Retainer**

Head Diameter: 18mm
Stem Length (Excluding Pin): 12mm
Fits into 9mm Hole
Honda, Mazda 626 & Toyota Corolla 1992 - On

UNIT PACKAGE: 15



19246

(01553-09241)
Black Nylon

Bumper Push-Type Retainer

Head Diameter: 18mm
Stem Length: 15mm
Fits into 10mm Hole
Nissan 240SX & Maxima 1994 - On

UNIT PACKAGE: 15



19231

(91505-SL0-003)
Black Nylon

Push-Type Retainer

Head Diameter: 18mm
Stem Length: 12mm
Fits into 8mm Hole
Acura NSX 1991 - On

UNIT PACKAGE: 15



16726

(N808048S, W705532-S300)
Black Nylon

Front Bumper Stone Deflector Retainer

Head Diameter: 18mm
Stem Length: 18mm
Fits into 6.3mm (1/4") Square Hole
Ford Bronco, Ranger & Explorer 1989 - On

UNIT PACKAGE: 25



20988

(GM: 11589289;
Chrysler: 6508863-AA;
Ford: W713610-S300)
Black Nylon

**Air Distributor & Windshield Defroster
Push-Type Retainer**

Head Diameter: 18mm
Stem Length: 17.5mm
Panel Range: 2.0mm - 4.5mm
Fits into 6.5mm Hole
Buick Enclave, Chevrolet Equinox,
Chevrolet & GMC S & T Trucks, GMC Acadia and
Pontiac Torrent 2002 - On; Ford EcoSport 2018 - On;
Edge 2015 - On; Fusion 2013 - On; Ranger 2019 - On;
Transit 2014 - On; Escape 2019 - 2013; Expedition
2019 - 2018; Mustang 2019 - 2015; C-Max 2018 - 2013;
Focus 2018 - 2008; Bronco 2021 - On
Lincoln Nautilus 2019 - On; MKC 2019 - 2015;
MKZ 2019 - 2013; Navigator 2019 - 2018;
Continental 2018 - 2017

UNIT PACKAGE: 25



20545

(N811283-S)

Black Nylon & Santoprene Rubber

Trim Panel Push-Type Retainer

Head Diameter: 18mm
Stem Length: 18mm
Fits into 6.3mm Hole
Ford Expedition & Navigator 1997 - On

UNIT PACKAGE: 25



21098

(Chrysler: 6508197-AA;
Ford: W706092-S300)
Black Nylon

**Front Air Shield, Splash Guard &
Heat Shield Push-Type Retainer**

Head Diameter: 18mm
Stem Length: 18mm
Fits into 6.4mm Hole
Dodge Ram 2006 - On
Ford Taurus 2008 - On

UNIT PACKAGE: 25



22535

(Chrysler: 6510123AA)
Black Nylon

**Rocker Panel &
Splash Shield Screw Grommet
with Specialty Screw**

Grommet Head Diameter: 18mm
Length Under Head: 36mm
Black Hex Washer Head Sems® Screw
Assembled in Grommet
Chrysler Pacifica, Dodge Challenger &
Ram and Jeep Cherokee 2011 - On

UNIT PACKAGE: 5

PUSH-TYPE RETAINERS

Refer to Retainer Specification Chart on pages 571-581

Listed smallest to largest by Head Diameter, Stem Length and then by Hole Diameter.



22354
(Chrysler: 6510139-AA)
Black Nylon

**Exterior Trim,
Floor, Pillar &
Quarter Panel Push-Type Retainer**

Head Diameter: 18mm
Stem Length: 18mm
Fits into 7mm Hole

Dodge Challenger & Charger 2011 - On

UNIT PACKAGE: 25



21089
(W710250-S300)
Black Nylon

Rear Bumper Push-Type Retainer

Head Diameter: 18mm
Stem Length: 18mm
Fits into 8mm Hole

Ford Edge 2007 - On

UNIT PACKAGE: 25



20367
(W706713-S300)
Black Nylon

**Bumper Cover
Push-Type Retainer**

Head Diameter: 18mm
Stem Length: 18mm
Fits into 8mm Hole

Ford Escape 2001 - On

UNIT PACKAGE: 25



19849
(Not Available from O.E.M.)
Black Nylon & Santoprene Rubber

Bumper Push-Type Retainer

Head Diameter: 18mm
Stem Length: 18mm
Fits into 8mm Hole

Ford Taurus & Sable 2000 - On

UNIT PACKAGE: 25



21123
(75867-30120)
Black Nylon

Rocker Moulding Push-Type Retainer

Head Diameter: 18mm
Stem Length: 19mm
Fits into 8mm Hole

Lexus GS350, GS430, GS460 & LS460 and
Toyota Camry 2007 - On

UNIT PACKAGE: 15



21672
(11611110)
Black Nylon

**Cowl Vent Push-Type
Retainer with Sealer**

Head Diameter: 18mm
Stem Length: 20mm
Fits into 6.3mm Hole

Buick Allure & LaCrosse &
Chevrolet Volt 2010 - On

UNIT PACKAGE: 15



20880
(GM:11589290; Chry.: 6509049AA)
Black Nylon

**Air Inlet Grille, Bumper Fascia &
Front Brake Caliper Cooling Duct
Push-Type Retainer**

Head Diameter: 18mm
Stem Length: 20mm

Panel Range: 4.5mm - 7.0mm
Fits into 6.5mm Hole

Buick Enclave, Cadillac, CTS & STS,
Chevrolet Cobalt, Equinox & SSR, GM Trucks &
Pontiac G5 & Torrent 2002 - On
Chrysler Charger & 300 2011 - On

UNIT PACKAGE: 50



22227
(Ford: W718088-S300)
Black Nylon

**Fender Apron
Push-Type Retainer**

Head Diameter: 18mm
Stem Length: 20mm

Fits into 7mm Hole
Ford Fusion 2015 - On

UNIT PACKAGE: 25



20966
(5160260-AA)
Black Nylon

**Rear Bumper, Tail Light &
Fender Push-Type Retainer**

Bottom Head Diameter: 18mm
Stem Length: 20mm

Fits into 8mm Hole

Dodge Caliber and Jeep
Compass & Patriot 2007 - On

UNIT PACKAGE: 15



20613
(63848-40Y00)
Black Nylon

Front Bumper Push-Type Retainer

Head Diameter: 18mm
Stem Length: 20mm

Fits into 9mm Hole

Nissan Frontier & Xterra 1998 - On

UNIT PACKAGE: 15

PUSH-TYPE RETAINERS

Refer to Retainer Specification Chart on pages 571-581

Listed smallest to largest by Head Diameter, Stem Length and then by Hole Diameter.



22049

(Mazda: B27K-51-PS7)
Black Nylon

Headlight Bracket Push-Type Retainer

Head Diameter: 18mm
Stem Length: 20mm
Fits into 9mm Hole
Mazda 3, CX-7, CX-9, Miata,
MPV & RX-8 2000 - On

UNIT PACKAGE: 15



20888

(GM: 11561368;
Chrysler: 6508712AA)
Black Nylon

**Fender, Wheel & Bumper
Push-Type Retainer**

Head Diameter: 18mm
Stem Length: 20mm
Panel Range: 3.0mm - 5.8mm
Fits into 9.5mm Hole
Chevrolet Impala & Monte Carlo and
Pontiac Grand Prix & Solstice 2004 - On
Jeep Wrangler 2000 - On

UNIT PACKAGE: 25



17057

(90505-SM4-003)
Black Nylon

Push-Type Retainer

Head Diameter: 18mm
Stem Length: 21mm
Fits into 8mm Hole
Honda Accord 1990 - On

UNIT PACKAGE: 10



20989

(GM: 11589291;
Ford: W713331-S300)
Black Nylon

Air Dam & Grille Push-Type Retainer

Head Diameter: 18mm
Stem Length: 22mm
Panel Range: 7.0mm - 9.5mm
Fits into 6.5mm Hole
Cadillac CTS, SRX, and STS 2003 - On

UNIT PACKAGE: 25



21529

(95230842)
Black Nylon

**Cowl Vent Push-Type
Retainer with Sealer**

Head Diameter: 18mm
Stem Length: 22mm
Fits into 6.5mm Hole
Chevrolet Cruze 2011 - On

UNIT PACKAGE: 15



20327

(63848-9E001)
Black Nylon

**Bumper Fascia
Push-Type Retainer**

Head Diameter: 18mm
Stem Length: 22mm
Fits into 9mm Hole
Nissan Altima 1997 - On

UNIT PACKAGE: 10



14018

(N803716-S)
Black Nylon

Fascia Retainer

Head Diameter: 18mm
Stem Length: 23mm
Fits into 7mm Hole
Ford Mustang/Capri 1985 - On

UNIT PACKAGE: 25



22219

(GM: 92138636)
Black Nylon

Air Baffle Push-Type Retainer

Head Diameter: 18mm
Stem Length: 23mm
Fits into 7.5mm Hole
Chevrolet Caprice 2013 - 2012
Pontiac G8 and GTO 2009 - 2004

UNIT PACKAGE: 25



18939

(90467-09101)
Black Nylon

**Bumper Cover
Push-Type Retainer**

Head Diameter: 18mm
Stem Length: 23mm
Fits into 9mm Hole
Lexus ES300 1993 - On

UNIT PACKAGE: 25



16622

(10157900,
11517803, 15993201)
Black Nylon

Front Bumper Fascia Retainer

Head Diameter: 18mm
Stem Length: 23mm
Fits into 9.5mm (3/8") Hole
Olds Cutlass 1990 - On
GM Lt. Truck 1996 - On

UNIT PACKAGE: 25

PUSH-TYPE RETAINERS

Refer to Retainer Specification Chart on pages 571-581

Listed smallest to largest by Head Diameter, Stem Length and then by Hole Diameter.



20631
(11588988)
Black Nylon

Front Bumper Cover Push-Type Retainer
Head Diameter: 18mm
Stem Length: 26mm
Fits into 10mm Hole
Pontiac Grand Prix 2004 - On

UNIT PACKAGE: 25



20359
(11519444)
Black Nylon

Bumper Cover Push-Type Retainer
Head Diameter: 18mm
Stem Length: 26mm
Fits into 10mm Hole
Oldsmobile Intrigue, Pontiac Aztek & Grand Prix 1997 - On

UNIT PACKAGE: 25



18873
(52161-16010, 52161-02020)
Black Nylon

Rear Bumper Cover Push-Type Retainer
Head Diameter: 18mm
Stem Length: 28mm
Fits into 9mm Hole
Toyota Tercel 1988 - On

UNIT PACKAGE: 6



20931
(52161-20010)
Black Nylon

Bumper Cover & Grille Push-Type Retainer
Head Diameter: 18mm
Stem Length: 31mm
Fits into 9mm Hole
Toyota 2000 - On

UNIT PACKAGE: 15



19422
(6504521)
Black Nylon

Fascia Push-Type Retainer
Head Diameter: 23/32" (18.3mm)
Stem Length: 29/32" (23mm)
Fits into 5/16" (8mm) Hole
Chrysler LHS, Concorde, Intrepid & Eagle Vision 1998 - On

UNIT PACKAGE: 25



21479
(701-867-299)
Gray Nylon

Front Bumper & Interior Trim Push-Type Retainer
With 3mm Allen Head Drive
Head Diameter: 18.5mm
Stem Length: 11mm
Fits into 9mm Hole
VW Jetta & Passat 1999 - On

UNIT PACKAGE: 25



20768
(4806240AA)
Black Nylon

Rear Bumper Push-Type Retainer
Large Head Diameter: 18.5mm
Stem Length: 21mm
Fits into 8mm Hole
Chrysler 300 & Dodge Magnum 2005 - On

UNIT PACKAGE: 10



23694
(H447RX9)
Black Nylon

Headlining Push-Type Retainer
Head Diameter: 19mm
Stem Diameter: 7mm
Stem Length: 11mm
Omni & Horizon 1979 - On

UNIT PACKAGE: 50



21201
(90467-07211)
Black Nylon

Bumper, Radiator Cover & Grille Push-Type Retainer
Head Diameter: 19mm
Stem Length: 8mm
Fits into 7mm Hole
Lexus IS & LS, Scion and Toyota Avalon, Camry & Highlander 2005 - On

UNIT PACKAGE: 10



21525
(53259-0E010)
Black Nylon

Front Inner Structure Push-Type Retainer
Head Diameter: 19mm
Stem Length: 9mm
Fits into 7mm Hole
Lexus EX 350, IS 250, IS 350, RX 330, RX350 and RX 400H 2004 - On

UNIT PACKAGE: 15

PUSH-TYPE RETAINERS

Sec. 19

Refer to Retainer Specification Chart on pages 571-581

Listed smallest to largest by Head Diameter, Stem Length and then by Hole Diameter.



22248

(Land Rover: DYQ500060)
Black Nylon

**Exterior Pillar Moulding
Push-Type Retainer**

Top Head Diameter: 19mm
Bottom Head Diameter: 13mm
Stem Length: 12mm
Fits into 8mm Hole
Range Rover Sport 2012 - 2006

UNIT PACKAGE: 25



11706

(387944-S)
Black Nylon

Grille to Metal Stamping Retainer

Head Diameter: 3/4" (19mm)
Shoulder Length: 1/4" (6.4mm)
Stem Length: 11/16" (17.5mm)
Fits into 1/4" (6.4mm) Wide Slot
Ford Truck 1978 - On

UNIT PACKAGE: 50



20826

(11609417)
Black Nylon

Fender Apron Push-Type Retainer

Head Diameter: 19mm
Stem Length: 14mm
Panel Range: 2.7mm - 5.3mm
Fits into 8.5mm Hole
Buick Enclave & LaCrosse, Cadillac CTS, SRX & STS,
Chevrolet Cobalt, Equinox & Malibu, GM Trucks and
Pontiac G5, G6 & Torrent 2003 - On

UNIT PACKAGE: 50



20273

(Ford: N808791;
Chrysler: 5GC7IRC3AA, 5GF92RC3AA)
Gray Nylon

**Interior Trim, Dash & Console
Push-Type Retainer**

Head Diameter: 19mm
Shoulder Diameter: 10mm
Shoulder Length: 7mm
Stem Length: 22mm
Fits into 9mm Hole
Dodge Durango &
Ford Pick-Ups 1997 - On

UNIT PACKAGE: 25



20990

(GM: 15296830; Chrysler: 5116530-AA)
Black Nylon

**Fascia & General Purpose
Push-Type Retainer**

Head Diameter: 19mm
Stem Length: 16mm
Panel Range: 5.0mm - 7.0mm
Fits into 8mm Hole
GM 2007 - On

UNIT PACKAGE: 25



17988

(90467-09143)
Black Nylon

Push-Type Retainer

Head Diameter: 19mm
Stem Length: 26mm
Fits into 9mm Hole
Lexus 1990 - On

UNIT PACKAGE: 10



25338

(Lexus & Toyota: 90467-07222)
Black Nylon

**Mud Guard & Rocker Panel
Moulding Extension Push-Type Retainer**

Head Diameter: 19mm
Stem Length: 17mm
Stem Diameter: 7mm
Fits into 7mm Hole
Panel Range: 5.5mm
Lexus ES300, 350 2020-2019,
Toyota Avalon 2019-On, Camry 2018-On,
Prius 2016-On

UNIT PACKAGE: 25



22126

(Toyota: 53384-68010)
Black Nylon

Front Grille Push-Type Retainer

Rubber Head Diameter: 19mm
Bottom Head Diameter: 18mm
Stem Length: 28mm
Fits into 9mm Hole
Scion tC & Toyota RAV4 2005 - On

UNIT PACKAGE: 15

PUSH-TYPE RETAINERS

Refer to Retainer Specification Chart on pages 571-581

Listed smallest to largest by Head Diameter, Stem Length and then by Hole Diameter.



19245

(5BB14LX9)
Black Nylon

**Fascia to Front Bumper
Push-Type Retainer**
Top Head Diameter: 3/4" (19mm)
Stem Length: 1-1/8" (28.5mm)
Fits into 1/4" (6.4mm) Hole
Dodge Dakota 1994 - On

UNIT PACKAGE: 25



20755

(GD7A-50-EA1)
Black Nylon

**Bumper Cover & Grille
Push-Type Retainer**
Head Diameter: 19.5mm
Stem Length: 15mm
Fits into 10mm Hole
Mazda 1999 - On

UNIT PACKAGE: 10



18308

(3540858)
Black Nylon

**Radiator Air Baffle
Push-Type Retainer**
Large Head
Diameter: 3/4" (19mm)
Stem Length: 1-1/8" (28.5mm)
Fits into 1/4" (6.4mm) Hole
Cadillac Eldorado & Seville 1993 - On

UNIT PACKAGE: 25



21568

(57160FC000)
Black Nylon

Front Fender Push-Type Retainer
Top Head Length: 19.5mm
Bottom Head Diameter: 14mm
Stem Length: 15mm
Fits into 10mm Hole
Subaru Forester 2008 - 1998

UNIT PACKAGE: 25



20244

(25707329)
Green Nylon

Push-Type Retainer with Sealer
Head Diameter: 19mm
Stem Length: 32mm
Fits into 8mm Hole
Buick LeSabre, Oldsmobile Aurora
& Pontiac Bonneville 2000 - On

UNIT PACKAGE: 10



20577

(GM: 88970494, 88973676;
Toyota: 90467-07168)
Black Nylon

**Rocker Panel & Garnish Moulding
Push-Type Retainer**
Head Diameter: 20mm
Stem Length: 8mm (Excluding the Pin)
Fits into 7mm Hole
Pontiac Vibe 2003 - On
Lexus & Toyota 2000 - On

UNIT PACKAGE: 15



22710

(BMW: 51-48-1-884-779)
Black Nylon

**Radiator Cover, Sound Insulation &
Trunk Trim Push-Type Retainer**
Head Diameter: 19.5mm
Stem Length: 15mm
Fits into 7mm Hole
BMW 3 & 5 Series, M3 &
M5 1991 - 1982

UNIT PACKAGE: 25



19908

(90467-07121)
Black Nylon

**Door Trim Panel
Push-Type Retainer**
Head Diameter: 20mm
Stem Length: 8mm (Excluding the Pin)
Fits into 7mm Hole
Toyota RAV4 1997 - On

UNIT PACKAGE: 10



22434

(Honda: 91514-SLN-A01)
Black Metal & Nylon

**Front Fender Liner &
Engine Cover Push-Type Retainer**
Phillips Truss Head Stainless Steel Screw
Head Diameter: 15.5mm
Grommet Head Size: 19.3mm x 19.3mm
Stem Length: 10mm
Fits into 10mm Hole
Honda Fit & Insight 2014 - 2007

UNIT PACKAGE: 5



19907

(90467-07121-B2)
Nylon

**Door Trim Panel
Push-Type Retainer**
Head Diameter: 20mm
Stem Length: 8mm (Excluding the Pin)
Fits into 7mm Hole
Toyota RAV4 1997 - On

UNIT PACKAGE: 10



PUSH-TYPE RETAINERS

Refer to Retainer Specification Chart on pages 571-581

Listed smallest to largest by Head Diameter, Stem Length and then by Hole Diameter.



18888

(90467-07166)
Black Nylon

Front Fender Liner Push-Type Retainer

Head Diameter: 20mm
Stem Length: 8mm (Excluding the Pin)
Fits into 7mm Hole
Toyota Tercel 1994 - On

UNIT PACKAGE: 15



21631

(84995-35101)
Black Nylon

Push-Type Retainer

Head Diameter: 20mm
Stem Length: 8mm (Excluding the Pin)
Fits into 8mm Hole
Nissan Sentra 2007 - On

UNIT PACKAGE: 15



19905

(01553-10051)
Black Nylon

Push-Type Retainer

Head Diameter: 20mm
Stem Length: 8mm (Excluding the Pin)
Fits into 8mm Hole
Nissan Maxima 1999 - On

UNIT PACKAGE: 15



23959

(90467-07195)
Black Nylon

Cowl Vent Push-Type Retainer

Head Diameter: 20mm
Stem Length: 8.5mm
Fits into 7mm Hole
Toyota RAV4 2002

UNIT PACKAGE: 15



14369

(1395-68-676, 9926-50-635)
Black Nylon

Push-Type Retainer

Head Diameter: 20mm
Stem Length: 9mm
Fits into 6mm Hole
Mazda

UNIT PACKAGE: 15



19128

(90467-07044)
Black Nylon

Quarter Panel Wheel Opening Moulding Push-Type Retainer

Head Diameter: 20mm
Stem Length: 9mm
Fits into 7mm Hole
Toyota T-100 1992 - On

UNIT PACKAGE: 10



21294

(90467-07214)
Black Nylon

Radiator Splash Shield Push-Type Retainer

Head Diameter: 20mm
Stem Length: 9mm
Fits into 7mm Hole
Toyota Camry 2007 - On

UNIT PACKAGE: 25



20270

(51-48-1-938-725)
Black Nylon

Hood & Trunk Insulation Push-Type Retainer

Head Diameter: 20mm
Stem Length: 9mm
Fits into 7mm Hole
BMW Series 3, 5, & 7 2001 - 1984

UNIT PACKAGE: 25



21422

(909140051)
Black Nylon

Front Bumper & Quarter Panel Push-Type Retainer

Head Diameter: 20mm
Stem Length: 9mm (Excluding the Pin)
Fits into 7mm Hole
Subaru Impreza, Legacy,
Outback & Tribeca 2005 - On

UNIT PACKAGE: 15



22765

(Volvo: 3541113)
Black Nylon

Bumper, Windshield Trim, Trunk Trim & Mud Flap Push-Type Retainer

Head Diameter: 20mm
Stem Length: 8.3mm (Excluding Pin)
Fits into 8mm Hole
Volvo 940 & 960 1993 - 1991
C30, C70, S40, S60, S80, S90, V50, V60,
V70, V90, XC60, XC70 & XC90 2000 - On

UNIT PACKAGE: 25



16000

(Honda: 90675-SB3-003;
Mazda: FB01-56-964;
Nissan: 63876-95596)
Black Nylon

Push-Type Retainer

Head Diameter: 20mm
Stem Length: 9mm
Fits into 8mm Hole
Honda, Mazda & Nissan

UNIT PACKAGE: 25

PUSH-TYPE RETAINERS

Refer to Retainer Specification Chart on pages 571-581

Listed smallest to largest by Head Diameter, Stem Length and then by Hole Diameter.



19315
(BC1D-56-145)
Black Nylon

Mud Guard Push-Type Retainer
Head Diameter: 20mm
Stem Length: 9mm (Excluding the Pin)
Fits into 8mm Hole
Mazda Protege 1996 - On

UNIT PACKAGE: 15



17379
(91512-SM4-003)
Black Nylon

Fender Splash Shield Push-Type Retainer
Head Diameter: 20mm
Stem Length: 9mm
Fits into 8mm Hole
Honda Accord 1990 - On

UNIT PACKAGE: 10



20637
(123-990-02-92)
Black Nylon

Push-Type Retainer
Head Diameter: 20mm
Stem Length: 9mm
Fits into 8mm Hole
Mercedes-Benz

UNIT PACKAGE: 10



19274
(01553-09321)
Black Nylon

Push-Type Retainer
Head Diameter: 20mm
Stem Length: 9mm (Excluding the Pin)
Fits into 8mm Hole
Nissan Maxima & 300ZX 1994 - On

UNIT PACKAGE: 15



21010
(90467-09166)
Black Nylon

Push-Type Retainer
Head Diameter: 20mm
Stem Length: 9mm
Fits into 9mm Square Hole
Toyota Camry 2006 - On

UNIT PACKAGE: 15



20908
(90467-07164)
Black Nylon

Fender Splash Shield Push-Type Retainer
Head Diameter: 20mm
Stem Length: 10mm
Fits into 7mm Hole
Toyota Camry, Echo, MR2 & Sienna 1997 - On

UNIT PACKAGE: 10



21571
(59122FA010)
Black Nylon

Front Bumper, Fender, Windshield Washer & Rocker Moulding Push-Type Retainer
Head Diameter: 20mm
Stem Length: 10mm
Fits into 8mm Hole
Subaru B9 Tribeca, Baja, Forester, Impreza, Legacy & Outback 1998 - On

UNIT PACKAGE: 25



22270
(Subaru: 909140068)
Black Nylon

Front Fender Push-Type Retainer
Head Diameter: 20mm
Stem Length: 10mm
Fits into 8mm Hole
Subaru BRZ, Impreza, Legacy, Outback & XV Crosstrek 2012 - On

UNIT PACKAGE: 15



19118
(Honda: 91501-S04-003, Ford: W711712-S300)
Black Nylon

Front Fender Push-Type Retainer
Head Diameter: 20mm
Stem Length: 10mm
Fits into 8mm Hole
Honda Civic & Del Sol 1993 - On; Ford Escape 2016 - 2013, Explorer 2020 - On, Focus 2018 - 2012, Transit 2014 - On, C-Max 2013 - 2018, Focus 2012 - 2018, Bronco 2021 - On, Lincoln Aviator 2020 - On

UNIT PACKAGE: 15



21651
(91501-TR0-003)
Black Nylon

Fender Push-Type Retainer
Head Diameter: 20mm
Stem Length: 10mm
Fits into 8mm Hole
Honda Civic 2012 - On

UNIT PACKAGE: 25



21086
(203-990-01-92)
Black Nylon

Hood Insulation Push-Type Retainer
Head Diameter: 20mm
Stem Length: 10mm
Fits into 8mm Hole
Mercedes-Benz GL, M, R, SL & SLK 2005 - On

UNIT PACKAGE: 15

PUSH-TYPE RETAINERS

Refer to Retainer Specification Chart on pages 571-581

Listed smallest to largest by Head Diameter, Stem Length and then by Hole Diameter.



22306

(Mercedes: 000-991-49-40-M58)
Black Nylon

Lower Engine Cover, Interior Trim & Trunk Cover Liner Push-Type Retainer

Head Diameter: 20mm

Stem Length: 10mm

Fits into 8mm Hole

Mercedes-Benz C300, C400, C63, CLS400, CLS550, CLS63, GLK250, GLK350, S550, S63 & S65 2015 - On

UNIT PACKAGE: 15



19239

(GM: 11519949;
Honda: 91512-SX0-003;
Mitsubishi: MU000319;
Lexus & Toyota: 90467-08217)
Black Nylon

Front Fender, Bumper Support, Interior Trim & Washer Tank Push-Type Retainer

Head Diameter: 20mm

Stem Length: 11mm

Fits into 8mm Hole

Acura 3.5RL, Honda Accord, Prelude & Odyssey 1994 - On; Mitsubishi Lancer 2002 - On; GM 1997 - On; Lexus GX470 2009 - 2003; Toyota 4Runner 2009 - 2003, FJ Cruiser 2014 - 2007, Tacoma 2016 - 2005

UNIT PACKAGE: 25



21594

(909130051)
Black Nylon

Fender Liner, Duct & Lower Moulding Push-Type Retainer

Head Diameter: 20mm

Stem Length: 11mm

Fits into 7mm Hole

Subaru B9 Tribeca, Forester, Impreza, Legacy & Outback 2005 - On

UNIT PACKAGE: 15



17347

(01553-06721)
Black Nylon

Front & Rear Bumper Cover Push-Type Retainer

Head Diameter: 20mm

Stem Length: 11mm (Excluding the Pin)

Fits into 8mm Hole

Nissan Maxima & Infiniti 1990 - On

UNIT PACKAGE: 15



21592

(909140052)
Black Nylon

Push-Type Retainer

Head Diameter: 20mm

Stem Length: 11mm

Fits into 7mm Hole

Subaru B9 Tribeca, Impreza, Legacy & Outback 2005 - On

UNIT PACKAGE: 15



21297

(91503-S7A-003)
Black Nylon

Front Bumper Push-Type Retainer

Head Diameter: 20mm

Stem Length: 11mm

Fits into 10mm Hole

Honda Civic 2010 - On

UNIT PACKAGE: 15



22893

(BMW: 51-48-1-915-964)
Black Nylon

Hood Insulator & Rear Bumper Push-Type Retainer

Head Diameter: 20mm

Stem Diameter: 6.8mm

Stem Length: 11mm

Fits into 7mm Hole

BMW 128i, 135i, 135is, 318i, 318is, 323i, 323is, 325Ci, 325i, 325is, 325xi, 328Ci, 328i, 328is, 328xi, 330Ci, 330i, 330xi, 335d, 335i, 335is, 335xi, 525i, 525xi, 528i, 530i, 530xi, 535i, 535xi, 540i, 545i, 550i, 645Ci, 650i, 735iL, 740i, 740iL, 750iL, M3, M5, M6, X3, X4, X5, X6, Z3, Z4 & Z8 2017 - 1991; Mini-Cooper, Countryman & Paceman 2016 - 2011

UNIT PACKAGE: 50



17992

(90467-07138)
Black Nylon

Push-Type Retainer

Head Diameter: 20mm

Stem Length: 12mm

Fits into 7mm Hole

Lexus 1990 - On

UNIT PACKAGE: 10



21580

(59122AC030)
Black Nylon

Front Fender Push-Type Retainer

Head Diameter: 20mm

Stem Length: 12mm

Fits into 7mm Hole

Subaru B9 Tribeca, Baja, Forester Legacy & Outback 1995 - On

UNIT PACKAGE: 25

PUSH-TYPE RETAINERS

Refer to Retainer Specification Chart on pages 571-581

Listed smallest to largest by Head Diameter, Stem Length and then by Hole Diameter.



21500

(909140063)
Black Nylon

Cowl Vent Push-Type Retainer

Head Diameter: 20mm
Stem Length: 12mm
Fits into 7mm Hole
Subaru Legacy & Outback 2010 - On

UNIT PACKAGE: 10



22567

(Toyota: 90467-07220)
Black Nylon

Bumper Cover, Radiator Support, Under Cover & Wheel Opening Push-Type Retainer

Head Diameter: 20mm
Stem Length: 12mm
Fits into 7mm Hole
Lexus CT 200h, GX 460, IS 300, IS 350, LC 500h, NX 200t, NX 300h, RX 350 & RX 450h and Toyota 4Runner, C-HR, Camry, Corolla, Corolla iM, Prius, Prius Prime, Prius V & RAV4 2013 - On
Scion iM, tC & xB 2016 - 2008

UNIT PACKAGE: 25



21192

(Nissan: 01553-05323, 01553-05933, 01553-10721; Mazda: L33X13209)
Black Nylon

Cowl, Bumper, Fender Liner & Radiator Grille Push-Type Retainer

Head Diameter: 20mm
Stem Length: 12mm
Fits into 8mm Hole
Infiniti FX35, FX45, G35 and Nissan 2003 - On, Frontier 2019 - 2005, Versa Note 2017, NV200 2013 - On;
Mazda 2, 3, 5, 6, CX-5, CX-7 & CX-9 2007 - On

UNIT PACKAGE: 10



22039

(Nissan: 01553-2DR9A)
Black Nylon

Push-Type Retainer

Top Head Diameter: 16mm x 19mm
Bottom Head Diameter: 20mm
Stem Length: 12mm
Fits into 8mm Hole
Infiniti G20, JX35, Q45 & QX60 and Nissan Frontier, Maxima, NV, Pathfinder, Sentra, Versa & Xterra 2002 - On

UNIT PACKAGE: 15



21856

(Toyota: 51454-48010, 51454-0E010)
Black Nylon

Front Bumper Extension Mounting Bracket Push-Type Retainer

Head Diameter: 20mm
Stem Length: 12mm
Fits into 10mm Hole
Lexus IS CV, F, RX330 & RX400 Hybrid 2006 - On
Toyota Highlander, Sienna & Venza 2009 - On

UNIT PACKAGE: 15



22100

(GM: 11612035)
Black Nylon

Front Fender & Body Side Liner Push-Type Retainer

Head Diameter: 20mm
Stem Length: 12mm
Fits into 8.5mm Hole
Chevrolet Colorado & SS and GMC Canyon 2014 - On

UNIT PACKAGE: 25



20953

(11296-AG000)
Black Nylon

Front Bumper & Radiator Support Push-Type Retainer

Head Diameter: 20mm
Stem Length: 13mm
Fits into 8mm Hole
Infiniti FX 35/45 and Nissan Altima, Maxima & Quest 2002 - On

UNIT PACKAGE: 25



22894

(BMW: 07-14-7-401-727)
Black Nylon

Interior Trim Panel Push-Type Retainer

Head Diameter: 20mm
Stem Diameter: 7.8mm
Stem Length: 13mm
Fits into 8mm Hole
BMW 228i 2016 - 2014
230i, M2, M235i, M240i & X3 2017 - On
320i, 320iX, 328d, 328dX, 328i, 328iX, 330e, 335i, 335iX, 340i, 340iX, 530e, 530eX, 530i, 540dX, 540i, 640iX, 740eX, 750i, B7 & M3 2019 - 2011, 330i, 330iX, 540iX, 740i, 740iX, 745eX, 750iX, 840i, 840iX, M5, M550iX, M760iX, M8, M850iX, X1, X2, X4, X5, X6, X7 & Z4 2015 - On
Mini-Cooper & Countryman 2017 - On

UNIT PACKAGE: 25



20516

(W706182-S300)
Black Nylon

Headlight Mounting & Deck Lid Push-Type Retainer

Head Diameter: 20mm
Hex: 10mm
Stem Length: 13mm
Fits into 8mm Hole
Ford Expedition, Explorer & Focus 2000 - On

UNIT PACKAGE: 25

PUSH-TYPE RETAINERS

Refer to Retainer Specification Chart on pages 571-581

Listed smallest to largest by Head Diameter, Stem Length and then by Hole Diameter.



22112

(Honda: 91512-STK-A01)
Black Nylon

**Garnish & Rear Spoiler
Push-Type Retainer with Sealer**

Head Diameter: 20mm
Stem Length: 13mm
Fits into 8.5mm Hole
Acura RDX & TSX and Honda Accord, CR-V
& Odyssey 2011 - On

UNIT PACKAGE: 10



22068

(Honda: 91513-SJK-003)
White Nylon

**Rocker, Pillars, Spoiler, Garnish & Exterior
Trim Push-Type Retainer with Sealer**

Head Diameter: 20mm
Stem Length: 13mm
Fits into 8.5mm Hole
Acura MDX, RLX, TSX & ZDX and Honda
Accord, Civic, CR-V, Element,
Fit, Insight & Pilot 2007 - On

UNIT PACKAGE: 15



22069

(Honda: 91512-SJK-003)
White Nylon

**Rocker, Pillars, Garnish & Exterior Trim
Push-Type Retainer with Sealer**

Head Diameter: 20mm
Stem Length: 13mm
Fits into 8.5mm Hole
Acura ZDX 2013 - 2010
Honda Odyssey & Pilot 2005 - On

UNIT PACKAGE: 15



20986

(91505-S9A-003)
Black Nylon

**Front Bumper Push-Type Retainer
with Internal Metal Insert**

Head Diameter: 20mm
Stem Length: 13mm
Fits into 10mm Hole
Honda Civic 2006 - On

UNIT PACKAGE: 10



22446

(Honda: 91503-TIW-003)
Gray Nylon

**Bumper
Push-Type Retainer**

Head Diameter: 20mm
Stem Length: 13mm
Fits into 10mm Hole
Honda CR-V 2015 - On

UNIT PACKAGE: 15



19233

(91503-SZ3-003)
Black Nylon

Front Bumper Push-Type Retainer

Head Diameter: 20mm
Stem Length: 13mm
Fits into 10mm Hole
Acura 3.5RL Sedan & Honda 1996 - On

UNIT PACKAGE: 15



25259

(TOYOTA: 90467-10216)
Black Nylon

**Fender Apron & Interior
Trim Push-Type Retainer**

Head Diameter: 20mm
Stem Length: 13mm
Fits into 10mm Hole
Toyota Avalon, RAV4 2013 - On, Camry
2018 - On, CH-R 2017 - On, Corolla 2019 - On,
Highlander 2014 - On, Land Crusier 2016 - On,
Mirai, Sienna, Venza 2021 - On, Prius 2012 - On,
Yaris 2018 - 2015, Scion iQ 2013

UNIT PACKAGE: 25



22459

(Chrysler: 6509761-AA)
Black Nylon

**Front Bumper
Push-Type Retainer**

Head Diameter: 20mm
Stem Length: 13.5mm
Fits into 10mm Hole
Dodge Ram &
Jeep Cherokee 2010 - On

UNIT PACKAGE: 15



25324

(Chrysler: 68053681AA)
Natural Nylon

**Lower Bumper Deflector
Push-Type Retainer**

Head Diameter: 20mm
Stem Length: 13.4mm
Stem Diameter: 11.5mm
Fits into 10mm Hole
RAM 1500 2009 - On

UNIT PACKAGE: 25



22856

(Chrysler: 6512734AA)
Black Nylon

**Tail Lamp Mounting
Push-Type Retainer**

Head Diameter: 20mm
Stem Length: 13.4mm
Fits into 10mm Hole
Dodge Ram 2019 - On

UNIT PACKAGE: 15

PUSH-TYPE RETAINERS

Refer to Retainer Specification Chart on pages 571-581

Listed smallest to largest by Head Diameter, Stem Length and then by Hole Diameter.



16782

(Honda: 91545-SE0-003-W1;
Nissan: 63848-01G00)
Black Nylon

Push-Type Retainer

Head Diameter: 20mm
Stem Length: 8mm (Excluding the Pin)
Fits into 8mm Hole

UNIT PACKAGE: 25



21134

(01553-09431)
Black Nylon

Front Bumper Push-Type Retainer

Head Diameter: 20mm
Stem Length: 11mm (Excluding the Pin)
Fits into 8mm Hole
Nissan Maxima 2004 - On

UNIT PACKAGE: 15



22424

(Mazda: B45A-56-146A;
Toyota: 90118-WB048)
Black Nylon

Bumper, Engine Cover, Fender & Quarter Panel Push-Type Retainer

Head Diameter: 20mm
Stem Length: 13mm
Fits into 8mm Hole
Mazda 3, 5, 6, CX-3, CX-5, CX-9 & MX-5 Miata 2012 - On
Scion iA 2016 - On

UNIT PACKAGE: 25



22515

(Mazda: BGV4-56-145)
Black Nylon

Bumper Cover & Fender Liner Push-Type Retainer

Head Diameter: 20mm
Stem Length: 14mm
Fits into 8mm Hole
Mazda 2, 3, 6, CX-9 & Miata 2010 - On

UNIT PACKAGE: 25



20638

(BMW: 51471911992,
51470146782, 51470390017
Mercedes-Benz: 201-990-02-92)
Black Nylon

Push-Type Retainer

Head Diameter: 20mm
Stem Length: 14mm
Fits into 8.5mm Hole
BMW 1, 2, 3, 4, 5, 6, 7, i3, i8, X & Z Series 1988 - On
Mercedes-Benz

UNIT PACKAGE: 25



25216

(Mercedes: 000-991-39-40)
Black Nylon

Interior Trim Panel Push-Type Retainer

Head Diameter: 20mm
Stem Length: 14mm
Fits into 8.5mm Hole
Mercedes G550, G63 AMG 2019 - On
Metris 2020 - 2016
Sprinter 1500, 2500, 3500 2010 -On

UNIT PACKAGE: 25



20608

(91503-S0K-A01)
Black Nylon

Grille Mounting Push-Type Retainer

Head Diameter: 20mm
Stem Length: 14mm
Fits into 10mm Hole
Honda Element 2003 - On

UNIT PACKAGE: 15



21706

(Honda: 91505-TM8-003)
Black Nylon

Bumper and Wheel Well Liner Push-Type Retainer

Head Diameter: 20mm
Stem Length: 14mm
Fits into 10mm Hole
Acura ILX and Honda Insight 2012 - On

UNIT PACKAGE: 15

PUSH-TYPE RETAINERS

Sec. 19

Refer to Retainer Specification Chart on pages 571-581
Listed smallest to largest by Head Diameter, Stem Length and then by Hole Diameter.



20734

(51-11-1-944-537)
Black Nylon

Bumper, Wheel Opening, Scuff Plate & Interior Trim Push-Type Retainer

Head Diameter: 20mm
Stem Length: 15mm
Fits into 6.3mm Hole
BMW Series 3, 5, 7 & X5 1989 - On

UNIT PACKAGE: 50



21545

(01553-08231)
Black Nylon

Front & Rear Bumper and Grille Push-Type Retainer

Head Diameter: 20mm
Stem Length: 15mm
Fits into 8mm Hole
Infiniti FX35, FX45 & Q45 and Nissan Murano, 240 SX & 350Z 1995 - On

UNIT PACKAGE: 25



17350

(Honda: 91516-SK7-013;
Nissan: 01553-00-344)
Black Nylon

**Splash Shield Push-Type Retainer
Phillips Drive**

Head Diameter: 20mm
Hex: 10mm
Stem Length: 15mm
Fits into 8mm Hole
Honda Civic 1992 - On
Nissan Xterra, Frontier & Quest 1999 - On

UNIT PACKAGE: 10



17267

(91503-SP0-003)
Black Nylon

Front & Rear Bumper Push-Type Retainer

Head Diameter: 20mm
Stem Length: 15mm
Fits into 10mm Hole
Acura Legend 1991 - On

UNIT PACKAGE: 15



21563

(909130059)
Black Nylon

Front Bumper & Fender Push-Type Retainer

Head Diameter: 20mm
Stem Length: 15mm
Fits into 10mm Hole
Subaru Forester, Impreza & Outback 2006 - 2002

UNIT PACKAGE: 25



20388

(51218-205-295)
Black Nylon

Cowl Vent Push-Type Retainer

Head Diameter: 20mm
Stem Length: 16mm
Fits into 7mm Hole

Use with Auveco 20254
BMW Series 5 1997 - On

UNIT PACKAGE: 50



21596

(75867-06030)
Black Nylon

Rocker Panel Push-Type Retainer

Head Diameter: 20mm
Stem Length: 16mm
Fits into 8mm Hole

Toyota & Lexus 2007 - On

UNIT PACKAGE: 25



21173

(91506-S9A-003)
Black Nylon

Bumper & Splash Shield Push-Type Retainer with Metal Insert

Head Diameter: 20mm
Stem Length: 16mm
Fits into 10mm Hole
Acura MDX, RDX & TSX and Honda Accord, Civic CR-V & Fit 2009 - 2004

UNIT PACKAGE: 10



20766

(6507669-AA)
Black Nylon

Radiator Grille Push-Type Retainer

Head Diameter: 20mm
Stem Length: 16mm
Fits into 10mm Hole
Dodge Durango 2004 - On

UNIT PACKAGE: 25

PUSH-TYPE RETAINERS

Refer to Retainer Specification Chart on pages 571-581

Listed smallest to largest by Head Diameter, Stem Length and then by Hole Diameter.



20248
(51-11-8-174-185)
Black Nylon

Bumper Trim Push-Type Retainer
Head Diameter: 20mm
Stem Length: 17mm
Fits into 6.3mm Hole
BMW Series 3, 5 & 7 1995 - On
UNIT PACKAGE: 25



22052
(BMW: 51471919209)
Black Nylon

Interior Trim & Engine Intake Duct Push-Type Retainer
Head Diameter: 20mm
Stem Length: 17mm
Fits into 6.3mm Hole
BMW 3, 5, 7, 8, X and Z Series 2012 - 1984
UNIT PACKAGE: 25



20458
(6506132-AA)
Black Nylon

Side Radiator Shield Push-Type Retainer
Head Diameter: 20mm
Stem Length: 17mm
Fits into 7mm Hole
Chrysler Sebring & Stratus 2001 - On
UNIT PACKAGE: 25



16858
(Nissan: 63844-01A00;
Kia: MNA01-56-145;
Mazda: NA01-56-145;
Ford: MNA01-56145, NA01-56145)
Black Nylon

Inner Fender Push-Type Retainer
Head Diameter: 20mm (25/32")
Stem Length: 18mm (23/32")
Fits into 8mm (5/16") Hole
Nissan 1980 - On
Mazda, Kia & Ford
UNIT PACKAGE: 25



20564
(91503-SZ5-003)
Black Nylon

Front & Rear Bumper Push-Type Retainer
Head Diameter: 20mm
Stem Length: 18mm
Fits into 10mm Hole
Acura 3.5RL and Honda Accord & Odyssey 1996 - On
UNIT PACKAGE: 15



21119
(B100-68-675-69)
Black Nylon

Push-Type Retainer
Head Diameter: 20mm
Stem Length: 19mm
Fits into 6mm Hole
Ford Probe and Mazda MX6 1988 - On
UNIT PACKAGE: 15



17472
(Mitsubishi: MB547806;
Nissan: 63854-01A00)
Black Nylon

Front Bumper Fascia Push-Type Retainer
Head Diameter: 20mm
Stem Length: 20mm
Fits into 8mm Hole
Mitsubishi & Nissan 300ZX 1990 - On
UNIT PACKAGE: 15



17216
(GM: 21030249; Ford: N807389S,
W711035-S300; Chry: 6503598)
Black Nylon

Air Baffle to Under Carriage Push-Type Retainer
Head Diameter: 20mm
Stem Length: 20mm
Fits into 8mm Hole
GM Saturn 2 Door & 4 Door Models 1991 - On;
Ford EcoSport 2018 - On; Escape, F-250, 350, 450,
550 2019 - 2017; Expedition 2018; Explorer 2006 - On;
Fiesta 2019 - 2011; Fusion 2013 - On; Mustang 2018 -2015;
Transit 2015 - On; Bronco 2021 - On;
Lincoln MKC 2019 - 2015; MKZ 2019 - 2013;
Mariner 2011 - 2007; Mountaineer 2010 - 2006,
Navigator 2019 - 2015 & Chrysler

UNIT PACKAGE: 25



20991
(11589292)
Black Nylon

Bumper Fascia, Flares & Air Dam Push-Type Retainer
Head Diameter: 20mm
Stem Length: 20mm
Panel Range: 2.0mm - 4.5mm
Fits into 8.5mm Hole
Chevrolet and GMC C & K Trucks 2007 - On
UNIT PACKAGE: 25



23993
(11571109)
Nylon

Air Dam, Fender Flares & Apron, Bumper, Grille Push-Type Retainer
Head Diameter: 20mm
Stem Length: 20mm
Fits into 8.5mm Hole
GM Malibu & Camaro 2007 - On
UNIT PACKAGE: 25



16625
(10108746)
Black Nylon

Front Bumper Fascia Retainer
Head Diameter: 20mm
Stem Length: 20mm
Fits into 10mm Square Hole
GM Station Wagons 1991 - On
UNIT PACKAGE: 25

PUSH-TYPE RETAINERS

Refer to Retainer Specification Chart on pages 571-581

Listed smallest to largest by Head Diameter, Stem Length and then by Hole Diameter.



19140

(Acura: 90505-SL0-003;
GM: 94852368;
Mitsubishi: MB888869;
Toyota: 90467-08155)
Black Nylon

Push-Type Retainer
Head Diameter: 20mm
Stem Length: 21mm
Fits into 8mm Hole

Acura, Dodge Avenger, Eagle Talon, Geo Prizm,
Mitsubishi Eclipse & Galant and Toyota 1993 - On

UNIT PACKAGE: 5



25214

(Mercedes: 230-990-00-92-9C75)
Dark Gray Nylon

Interior Trim Push-Type Retainer
Head Diameter: 20mm
Stem Length: 21mm
Fits into 8.5mm Hole

Mercedes A220, CLS 450, CLS53 AMG, G550, G63 AMG,
Sprinter 1500 2019 - On, B250e 2017 - 2015,
C230 2007 - 2003, C240, C320 2005 - 2001, C280,
ML500 2007 - 2006, C300, C63 AMG 2009 - 2008, C32
AMG 2004 - 2002, C350, CLK350 2009 - 2006, C55 AMG
2006 - 2005, CL550, C600 2014 - 2007, CL63,
CL65 AMG 2014 - 2008, CLA250, CLA45
AMG 2014 - On, CLK320 2005 - 2003, CLK500,
CLK55 AMG, E500, E55 AMG 2006 - 2003, CLK550, GL320
2009 - 2007, CLK63 AMG 2008 - 2007, E300, GLC300,
GLS450, GLS550, GLS63 AMG, SL450, SLC300, SLC43 AMG
2019 - 2017, E320 2009 - 2003, E350 2016 - 2006,
E400 2018 - 2015, E43 AMG 2018 - 2017, E450, E53 AMG,
GLC43 AMG, GLE43 AMG 2019, E550, S550,
S600 2017 - 2007, E63 AMG, S65 AMG 2019 - 2007, GL350
2016 - 2010, GL450 2016 - 2007,
GL550 2016 - 2008, GL63 AMG 2016 - 2013, GLA250,
GLA45 AMG 2015 - On, GLC63 AMG, S450,
S560 2019 - 2018, GLE300d 2017 - 2016, GLE350, GLE550e
2018 - 2016, GLE400, GLE63 AMG,
Metris 2019 - 2016, GLE450 AMG 2016,
GLS350d 2017, ML320 2009 - 2007,
ML350 2011 - 2006, ML450 2011 - 2010,
ML550 2011 - 2008, ML63 AMG 2011 - 2007,
S350 2013 - 2012; S400 2013 - 2010, S63
AMG 2019 - 2008, SL400 2016 - 2015, SL550,
SL63 AMG 2019 - 2013; SL65 AMG 2018 - 2013, SLK250
2015 - 2012, SLK280 2008 - 2006,
SLK300 2016 - 2009, SLK350,
SLK55 AMG 2016 - 2005, Sprinter 2500, 3500 2010-On

UNIT PACKAGE: 25



21778

(BMW: 51-12-7-004-445)
Black Nylon

**Rear Bumper Support Fixture Trim
Push-Type Retainer**
Head Diameter: 20mm
Stem Length: 21mm
Fits into 8.5mm Hole
3, 5 & 6 Series 2002 - On

UNIT PACKAGE: 25



19615

(15153415)
Black Nylon

**Rear Bumper Cover
Push-Type Retainer**
Top Head Diameter: 20mm
Stem Length: 21mm
Fits into 9mm Hole
GM C & K Trucks 1999 - On

UNIT PACKAGE: 25



25222

(GM: 90450482;
Mercedes: 001-990-16-92-64)
Black Nylon

Mud Guard Push-Type Retainer
Head Diameter: 19mm
Stem Length: 15mm
Fits into 8mm Hole

Buick Regal 2020 - 2018 Mercedes ML320 2003- 1998,
ML350 2005 - 2003, ML430 2001 - 1999,
ML500 2005 - 2002, ML55 AMG 2003 - 2000,
Sprinter 1500, 2500, 3500 2019 - On

UNIT PACKAGE: 25



22419

(Honda: 90501-SDR-003)
Black Nylon

**Rocker Moulding & Mud Guard
Push-Type Retainer**

Head Diameter: 20mm
Stem Length: 21mm
Fits into 10mm Hole
Acura RDX, RL & RLX and
Honda CR-V & Accord 2009 - On

UNIT PACKAGE: 25



20889

(GM: 11589293;
Ford: W712196-S300)
Black Nylon

**Cowl Vent & Fender
Push-Type Retainer**

Head Diameter: 20mm
Stem Length: 22mm
Panel Range: 4.5mm - 7.0mm
Fits into 8.5mm Hole

Buick Century, LaCrosse & Regal, Cadillac, Chevrolet
Equinox, GM Trucks, Hummer H3 and
Pontiac Grand Prix & Torrent 1997 - On;
Ford Edge 2007 - On; Explorer 2020 - On;
Fusion 2006 - On; F-150 2019 - 2016; F-250,
F-350 2018 - 2017; Fiesta 2019 - 2011; Flex 2019 - 2009;
Bronco 2021 - On; Lincoln Aviator 2020 - On;
Nautilus 2019 - On; Continental 2019 - 2017;
MKC 2019 - 2015; MKT 2019 - 2010; MKX 2019 - 2007;
Milan 2011 - 2006

UNIT PACKAGE: 25

PUSH-TYPE RETAINERS

Refer to Retainer Specification Chart on pages 571-581

Listed smallest to largest by Head Diameter, Stem Length and then by Hole Diameter.



25031

(Mercedes
230-990-00-92-9C75)
Black Nylon

**Hinge Cover
Push-Type Retainer**
Head Diameter: 20mm
Stem Length: 21mm
Stem Diameter: 9mm
Fits into 8.5mm Hole

Mercedes-Benz A220, CLS 450, CLS53 AMG, G550, G63 AMG, Sprinter 1500 2019 - On; B250e 2017 - 2015; C230 2007 - 2003; C240, C320 2005 - 2001; C280, ML500 2007 - 2006; C300, C63 AMG 2009 - 2008; C32 AMG 2004 - 2002; C350, CLK350 2009 - 2006; C55 AMG 2006 - 2005; CL550, C600 2014 - 2007; CL63, CL65 AMG 2014 - 2008; CLA250, CLA45 AMG 2014 - On; CLK320 2005 - 2003; CLK500, CLK55 AMG, E500, E55 AMG 2006 - 2003; CLK550, GL320 2009 - 2007; CLK63 AMG 2008 - 2007; E300, GLC300, GLS450, GLS550, GLS63 AMG, SL450, SLC300, SLC43 AMG 2019 - 2017; E320 2009 - 2003; E350 2016 - 2006; E400 2018 - 2015; E43 AMG 2018 - 2017; E450, E53 AMG, GLC43 AMG, GLE43 AMG 2019; E550, S550, S600 2017 - 2007; E63 AMG, S65 AMG 2019 - 2007; GL350 2016 - 2010; GL450 2016 - 2007; GL550 2016 - 2008; GL63 AMG 2016 - 2013; GLA250, GLA45 AMG 2015 - On; GLC63 AMG, S450, S560 2019 - 2018; GLE300d 2017 - 2016; GLE350, GLE550e 2018 - 2016; GLE400, GLE63 AMG, Metris 2019 - 2016; GLE450 AMG 2016; GLS350d 2017; ML320 2009 - 2007; ML350 2011 - 2006; ML450 2011 - 2010; ML550 2011 - 2008; ML63 AMG 2011 - 2007; S350 2013 - 2012; S400 2013 - 2010; S63 AMG 2019 - 2008; SL400 2016 - 2015; SL550, SL63 AMG 2019 - 2013; SL65 AMG 2018 - 2013; SLK250 2015 - 2012; SLK280 2008 - 2006; SLK300 2016 - 2009; SLK350, SLK55 AMG 2016 - 2005; Sprinter 2500, 3500 2010 - On

UNIT PACKAGE: 25



17144

(91504-SM4-000)
Black Nylon

Bumper Fascia Push-Type Retainer
Head Diameter: 20mm
Stem Length: 24mm
Fits into 10mm Hole
Honda Accord 1990 - On

UNIT PACKAGE: 10

19408

Same as 17144 except for unit package quantity

UNIT PACKAGE: 50



18119

(91502-SP0-003)
Black Nylon

**Front & Rear Bumper
Push-Type Retainer**
Head Diameter: 20mm
Stem Length: 25mm
Fits into 10mm Hole
Honda 1990 - On

UNIT PACKAGE: 10

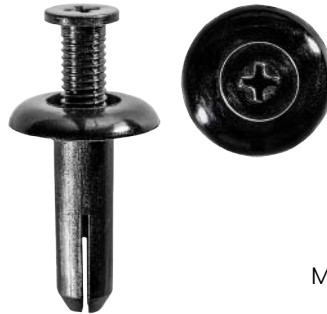

18951

(MR-138807)
Black Nylon

**Front Bumper & Support
Push-Type Retainer**
Head Diameter: 20mm
Stem Length: 26mm
Fits into 8mm Hole
Mitsubishi Eclipse 1994 - On

UNIT PACKAGE: 5



20348

(63878-01E10)
Black Nylon

Push-Type Retainer
Head Diameter: 20mm
Stem Length: 22mm
Fits into 8mm Hole
Nissan Maxima 1994 - On

UNIT PACKAGE: 15



20632

(GM: 11518017;
Ford: W708530-S300)
Black Nylon

**Bumper Cover & Fender Shield
Push-Type Retainer**
Head Diameter: 20mm
Stem Length: 26mm
Fits into 8mm Hole
GM & Ford 1997 - On

UNIT PACKAGE: 15



20992

(11589294)
Black Nylon

**Bumper Fascia, Fender and Toe/Floor
Panel Push-Type Retainer**
Head Diameter: 20mm
Stem Length: 24mm
Panel Range: 7.0mm - 10.0mm
Fits into 8.5mm Hole
Buick Enclave & LaCrosse, Chevrolet & GMC C & K Trucks, GMC Acadia, Hummer H3 and Saturn Outlook 2005 - On

UNIT PACKAGE: 25



19739

(90467-09127)
Black Nylon

Bumper Cover Push-Type Retainer
Head Diameter: 20mm
Stem Length: 26mm
Fits into 9mm Hole
Toyota Avalon, Camry, Corolla & Solara 1998 - On

UNIT PACKAGE: 10

PUSH-TYPE RETAINERS

Refer to Retainer Specification Chart on pages 571-581

Listed smallest to largest by Head Diameter, Stem Length and then by Hole Diameter.



23891

(90467-09128)
Nylon

**Bumper Cover
Push-Type Retainer**
Head Diameter: 20mm
Stem Length: 26.5mm
Fits into 9mm Hole
Lexus 1995 - 2000

UNIT PACKAGE: 10



20457

(4857345-AA)
Black Nylon

**Tail Light Housing
Push-Type Retainer**
Large Head Diameter: 21mm
Stem Length: 23mm
Fits into 9.5mm Hole
Chrysler Caravan, Town & Country and
Voyager Mini Vans 2002 - On

UNIT PACKAGE: 25



22299

(Hyundai: 86590-35000)
Black Nylon

**Bumper Cover
Push-Type Retainer**
Head Diameter: 20mm
Stem Length: 26mm
Fits into 9.5mm Hole
Hyundai Tucson 2009 - 2005

UNIT PACKAGE: 25



16835

(GM: 10140480;
Chrysler: 6502625)
Black Nylon

Rear Bumper Fascia Retainer
Head Diameter: 21mm (27/32")
Shoulder Length: 3mm (1/8")
Stem Length: 25mm (1")
Fits into 12mm (1/2") Hole
GM APV Vans 1990 - On

UNIT PACKAGE: 25



17143

(Honda: 91502-SM4-000;
Hyundai 86590-35000)
Black Nylon

Bumper Fascia Push-Type Retainer
Head Diameter: 20mm
Stem Length: 27mm
Fits into 10mm Hole
Honda Accord 1990 - On
Hyundai 2005 - On

UNIT PACKAGE: 10



14998

(15672330, 15956470)
Black Nylon

Push-Type Retainer
Head Diameter: 27/32" (21.4mm)
Stem Length: 1" (25.4mm)
Fits into 13/32" (10.3mm) Hole
GM 1987 - On

UNIT PACKAGE: 25

19407
Same as 17143 except unit package quantity

UNIT PACKAGE: 50



18896

(21095797)
Black Nylon

**Bumper Fascia
Push-Type Retainer**
Head Diameter: 20mm
Stem Length: 28mm
Fits into 8mm Hole
GM Saturn 1996 - On

UNIT PACKAGE: 25



22363

(Chrysler: 6510734-AA)
Black Nylon

**Front Bumper
Push-Type Retainer**
Head Diameter: 21.5mm
Stem Length: 14mm
Fits into 12.5mm Hole
Jeep Wrangler 2007 - On

UNIT PACKAGE: 15



21420

(909140007)
Black Nylon

**Bumper, Engine Cover, Fender & Grille
Push-Type Retainer**
Head Diameter: 21mm
Stem Length: 15mm (Excluding the Pin)
Fits into 10mm Hole
Subaru Baja, Forester, Impreza, Legacy,
Outback & Tribeca 2000 - On

UNIT PACKAGE: 15

PUSH-TYPE RETAINERS

Refer to Retainer Specification Chart on pages 571-581

Listed smallest to largest by Head Diameter, Stem Length and then by Hole Diameter.



20739

(WX68DX9-AA)
Black Nylon

**Door Trim Panel
Push-Type Retainer**

Head Diameter: 22mm
Stem Length: 10mm (Excluding the Pin)
Fits into 9mm Hole
Chrysler 300 & Dodge Magnum 2005 - On

UNIT PACKAGE: 25



21021

(0WX68BD5-AA)
Dark Gray Nylon

**Door Trim Panel
Push-Type Retainer**

Head Diameter: 22mm
Stem Length: 10mm (Excluding the Pin)
Fits into 9mm Hole
Chrysler Charger, Magnum & 300M 2005 - On

UNIT PACKAGE: 25



21427

(0WX68XDB-AA)
Light Gray Nylon

**Door Trim Panel
Push-Type Retainer**

Head Diameter: 22mm
Stem Length: 10mm (Excluding the Pin)
Fits into 9mm Hole
Chrysler 300M, Charger & Magnum 2005 - On

UNIT PACKAGE: 25



20948

(0WX68BD1-AA)
Tan Nylon

**Door Trim Panel
Push-Type Retainer**

Head Diameter: 22mm
Stem Length: 10mm (Excluding the Pin)
Fits into 9mm Hole
Chrysler 300M, Charger & Magnum 2005 - On

UNIT PACKAGE: 25



22722

(VW: WHT-004-994)
Black Nylon

**Interior Pillar
Push-Type Retainer**

Head Diameter: 22mm
Stem Length: 11mm (Including Pin)
Fits into 7.5mm Hole
Volkswagen Jetta 2011 - On

UNIT PACKAGE: 25



22101

(Audi: 4D0-807-300)
Black Nylon

**Bumper, Fender & Hood
Insulation Push-Type Retainer**

Head Diameter: 22mm
Stem Length: 12mm
Fits Into 7.5mm Hole
Audi A4, A5, A8, Q3, Q5 & S8 1997 - On

UNIT PACKAGE: 15



22095

(Audi: N90-229-301)
Black Nylon

**Hood Insulation
Push-Type Retainer**

Head Diameter: 22mm
Stem Length: 13mm
Fits into 8mm Hole
Audi & Volkswagen 1986 - On

UNIT PACKAGE: 25



20863

(5480772)
Black Nylon

**Lower Rocker Moulding
Push-Type Retainer**

Head Diameter: 22mm
Stem Length: 13mm (Excluding the Pin)
Fits into 15mm Hole
Chevrolet Equinox 2005 - On

UNIT PACKAGE: 10



17378

(01553-03101)
Black Nylon

**Bumper & Fascia
Push-Type Retainer**

Head Diameter: 22mm
Stem Length: 14mm (Excluding the Pin)
Shoulder Diameter: 11mm
Fits into 8mm Hole
Nissan 1986 - On

UNIT PACKAGE: 15



21860

(Toyota: 51453-48010, 51453-0E010)
Black Nylon

**Front Side Lower Fender Panel
Bracket Push-Type Retainer**

Head Diameter: 22mm
Stem Length: 14mm
Fits into 13mm Hole
Lexus RX330 2009 - 2004
Toyota Highlander 2010 - On

UNIT PACKAGE: 15

PUSH-TYPE RETAINERS

Refer to Retainer Specification Chart on pages 571-581

Listed smallest to largest by Head Diameter, Stem Length and then by Hole Diameter.



21366

(90467-09227)
Black Nylon

**Bumper & Engine Under Cover
Push-Type Retainer**

Head Diameter: 22mm
Stem Length: 15mm (Excluding the Pin)
Fits into 9mm Hole

Toyota 4 Runner, RAV 4 & Scion XB 2006 - On

UNIT PACKAGE: 10



20753

(01553-03201)
Black Nylon

**Front & Rear Bumper
Push-Type Retainer**

Head Diameter: 22mm
Stem Length: 21mm
Fits into 8mm Hole

Nissan 1982 - On

UNIT PACKAGE: 10



22568

(Toyota: 90467-09242)
Black Nylon

**Cowl Grille
Push-Type Retainer**

Head Diameter: 22mm
Stem Length: 15mm
Fits into 9mm Hole
Lexus RX 350 & RX 450h and
Toyota C-HR, Camry, Prius,
Prius Prime & Yaris 2016 - On

UNIT PACKAGE: 15



22282

(Mazda: FD01-68-AC3)
Gray Nylon

**Bumper Filler & Door Panel
Push-Type Retainer**

Head Diameter: 22mm
Stem Length: 25mm
Fits into 8mm Hole
Mazda 2, 3, 5, 6,
CX-5, CX-7 & CX-9
2004 - On

UNIT PACKAGE: 15



20967

(Not Available from O.E.M.)
Black Nylon

**Rear Bumper Mounting Bracket
Push-Type Retainer**

Head Diameter: 22mm
Stem Length: 16mm
Fits into 10mm Hole
Jeep Commander 2006 - On

UNIT PACKAGE: 15



18269

(6503106)
Black Nylon

**Lower Sill Moulding
Push-Type Retainer**

Large Head Diameter: 7/8" (22mm)
Stem Length: 1" (25.4mm)
Fits into 1/4" (6.4mm) Hole
Jeep Grand Cherokee Laredo 1994 - On

UNIT PACKAGE: 15



19847

(5973823)
Blue Nylon

Fascia Retainer

Head Diameter: 7/8" (22mm)
Shoulder Length: 5/32" (4mm)
Stem Length: 25/32" (20mm)
Fits into 1/2" (12.7mm) Hole
GM 1979 - On

UNIT PACKAGE: 25



15043

(14103461)
Black Nylon

Bumper Fascia Retainer

Head Diameter: 7/8" (22mm)
Shoulder Length: 5/32" (4mm)
Stem Length: 1-3/64" (26.5mm)
Fits into 1/2" (12.7mm) Hole
GM 1987 - On

UNIT PACKAGE: 25



25206

(Chrysler & Mitsubishi:
MU001220, MU000695)
Black Nylon

Bumper & Apron Push-Type Retainer

Head Diameter: 20mm
Stem Length: 20mm
Fit into 8mm Hole
Chrysler Sebring, Stratus 2005;
Mitsubishi Eclipse, Galant 2012 - 2006;
Endeavor 2008 - 2006 & 2010 - 2011;
Outlander 2006

UNIT PACKAGE: 25



21578

(57750AA090)
Black Nylon

**Front & Rear Bumper
Push-Type Retainer**

Head Diameter: 22mm
Stem Length: 28mm
Fits into 10mm Hole
Subaru Impreza & Legacy 2001 - 1993

UNIT PACKAGE: 25

PUSH-TYPE RETAINERS

Refer to Retainer Specification Chart on pages 571-581

Listed smallest to largest by Head Diameter, Stem Length and then by Hole Diameter.



21251

(6Q0-868-243)
Black & White Nylon

**Trim Panel
Push-Type Retainer with Sealer**
Head Diameter: 22.5mm
Stem Length: 8mm (Excluding the Pin)
Fits into 8mm Hole
Volkswagen Golf, Jetta, Passat, Phaeton,
Rabbit & Tiguan 2004 - On

UNIT PACKAGE: 15



20233

(W705956-S300)
Black Nylon

Cowl Push-Type Retainer
Head Diameter: 25mm
Shoulder Diameter: 10mm
Shoulder Length: 3mm
Stem Length: 12mm (Excluding the Pin)
Fits into 9mm Hole
Lincoln LS 1999 - On

UNIT PACKAGE: 15



22256

(Jaguar: XR831159)
Black Nylon

**Radiator Support &
Air Deflector Shield
Push-Type Retainer**
Head Diameter: 24mm
Stem Length: 12mm
Fits into 12mm Hole
Jaguar X, XF, XJ-L & XK 2012 - On

UNIT PACKAGE: 10



22047

(Subaru: 94415FA000NE)
Gray & Black Nylon

**Rear Roof Spoiler Trim
Push-Type Retainer**
Top Head Diameter: 25mm
Bottom Head Diameter: 21mm
Stem Length: 9mm (Not including the Pin)
Fits into 8mm Hole
Impreza 2007 - 1998

UNIT PACKAGE: 15



21482

(1H0-867-199-A)
Black Nylon

Push-Type Retainer
Head Diameter: 24mm
Stem Length: 13mm
Fits into 9mm Square Hole
VW Passat 1999 - 1990

UNIT PACKAGE: 25



22532

(Ford: W717823-S300)
Black Nylon

**Splash & Heat Shield
Push-Type Retainer**
Head Diameter: 25mm
Stem Length: 11mm
Fits into 6.5mm Hole
Ford Mustang
2014 - On

UNIT PACKAGE: 15



21376

(4389947-AA)
Black and White Nylon

**Bumper Cover
Push-Type Retainer with Sealer**
Head Diameter: 24mm
Shoulder Length: 3mm
Stem Length: 20mm
Fits into 11mm Hole
Chrysler Avenger, Journey &
Sebring 2008 - On

UNIT PACKAGE: 10



22848

(BMW: 07-14-7-281-961)
Black Nylon

**Rocker Moulding
Push-Type Retainer**
Head Diameter: 25mm
Stem Length: 19mm
Fits into 8mm Hole
BMW X3 2017 - 2011
X4 2015 - On

UNIT PACKAGE: 25



21176

(10382313)
Black Nylon

**Sight Shield & Trim
Push-Type Retainer**
Head Diameter: 24.5mm
Stem Length: 13mm (Excluding the Pin)
Fits into 9mm Hole
Cadillac STS, Pontiac Solstice and
Saturn Sky 2005 - On

UNIT PACKAGE: 10



21501

(909140055)
Black Nylon

**Rocker Moulding
Push-Type Retainer with Sealer**
Head Diameter: 25mm
Shoulder Length: 3mm
Shoulder Diameter: 16.5mm
Stem Length: 12mm (Excluding the Pin)
Fits into 11mm Hole
Subaru 2006 - On

UNIT PACKAGE: 5

PUSH-TYPE RETAINERS

Refer to Retainer Specification Chart on pages 571-581

Listed smallest to largest by Head Diameter, Stem Length and then by Hole Diameter.



23899

(Not Available from OEM)
Nylon

**Front Bumper Air Deflector
Push-Type Retainer**
Head Diameter: 25mm
Stem Length: 15mm
Fits into 8mm Hole
Ford Van E350 1993 - On

UNIT PACKAGE: 15



21576

(909140002)
Black Nylon

**Rocker, Pillar, Floor & Exterior Trim
Push-Type Retainer with Sealer**
Head Diameter: 25mm
Shoulder Diameter: 17mm
Shoulder Length: 3mm
Stem Length: 16mm (Excluding the Pin)
Fits into 11mm Hole

Subaru B9 Tribeca, Baja, Legacy & Outback 2000 - On

UNIT PACKAGE: 25



20993

(GM: 11589295; Ford: W712665-S300)
Black Nylon

**Fender, Flare, Gas Tank & Panel
Attachment Push-Type Retainer**
Head Diameter: 25mm
Stem Length: 20mm
Panel Range: 3.0mm - 6.0mm
Fits into 10.5mm Hole
Chevrolet Cobalt & HHR,
GM C & K Trucks &
Pontiac G5 2005 - On

UNIT PACKAGE: 25



20994

(11589296)
Black Nylon

**Panel Attachment &
General Purpose
Push-Type Retainer**
Head Diameter: 25mm
Stem Length: 23mm
Panel Range: 6.0mm - 9.00mm
Fits into 10.5mm Hole
Buick Enclave & GMC Acadia 2007 - On

UNIT PACKAGE: 25



22284

(Ford: W718365-S300)
Black Nylon

**Front Fender, Cowl Grille,
Rocker & Mudguard
Push-Type Retainer**
Head Diameter: 25mm
Stem Length: 24mm
Fits into 8.5mm Hole
Ford Mustang & Transit Connect and
Lincoln MKC 2014 - On

UNIT PACKAGE: 10



15701

(N804674-S)
Black Nylon

Push-Type Retainer
Head Diameter: 25mm
Stem Length: 27mm
Fits into 7mm Hole
Ford Mustang & Capri

UNIT PACKAGE: 50



21361

(GM: 11561874;
Nissan: 622A2-9E000A)
Black Nylon

**Bumper Cover
Push-Type Retainer**
Head Diameter: 25mm
Stem Length: 29mm
Fits into 7mm Hole
Chevrolet Malibu 2008 - On
Saturn Aura 2007 - On
Pontiac G6 2010 - On
Nissan Altima 1997 - On

UNIT PACKAGE: 15



24160

(Not Supplied by O.E.M.)
White Nylon

**Window Lift Motor
Mounting Retainer**
Hole: M12.7 (primary) & M9 (secondary)
Flange: 25mm
Pin Length: 47mm
Pin Head: 15mm
Chrysler Mini Vans 2001 - On

UNIT PACKAGE: 25



19244

(N808847-S)
Black Nylon

**Trunk Trim Panel
Push-Type Retainer**
Head Diameter: 1" (25.4mm)
Stem Length: 11/16" (17.5mm)
Fits into 1/4" (6.4mm) Square Hole
Ford Taurus & Sable 1996 - On

UNIT PACKAGE: 25



14010

(14045480)
Black Nylon

Fascia, Push-Type Retainer
Head Diameter: 1" (25.4mm)
Stem Length: 23/32" (18.3mm)
Fits into 3/8" (9.5mm) Hole
GM 1982 - On

UNIT PACKAGE: 25

PUSH-TYPE RETAINERS

Refer to Retainer Specification Chart on pages 571-581

Listed smallest to largest by Head Diameter, Stem Length and then by Hole Diameter.



12757

(5973400)
Black Nylon

Fascia, Push-Type Retainer
Head Diameter: 1" (25.4mm)
Shoulder Length: 1/8" (3.2mm)
Stem Length: 3/4" (19mm)
Fits into 1/2" (12.7mm) Hole
GM 1979 - On

UNIT PACKAGE: 15

16265

Same as 12757 except **unit package** quantity

UNIT PACKAGE: 50



14147

(20547865)
Black Nylon

Body Retainer
Head Diameter: 1" (25.4mm)
Stem Length: 7/8" (22mm)
Fits into 1/4" (6.4mm) Hole
GM 1984 - On

UNIT PACKAGE: 25



14020

(Ford: N802781-S; GM: 14093088)
Black Nylon

Splash Shield & Fascia Retainer
Head Diameter: 1" (25.4mm)
Stem Length: 7/8" (22mm)
Fits into 1/4" (6.4mm) Hole
GM & Ford

UNIT PACKAGE: 25



14019

(Ford: N803421-S, Chrysler: 6501590)
Black Nylon

Splash Shield & Fascia Retainer
Head Diameter: 1" (25.4mm)
Shoulder Length: 1/8" (3.2mm)
Stem Length: 7/8" (22mm)
Fits into 5/16" (8mm) Hole
Ford & Chrysler

UNIT PACKAGE: 25



13994

(GM: 20570245, 20635065;
Ford: N804614S)
Black Nylon

Splash Shield, Seat Cushion & Spare Tire Retainer
Head Diameter: 1" (25.4mm)
Stem Length: 7/8" (22mm)
Fits into 5/16" (8mm) Hole
GM 1984 - On; Ford

UNIT PACKAGE: 25



12756

(5973996)
Brown Nylon

Fascia Retainer
Head Diameter: 1" (25.4mm)
Shoulder Length: 1/4" (6.4mm)
Stem Length: 7/8" (22mm)
Fits into 1/2" (12.7mm) Hole
GM 1982 - On

UNIT PACKAGE: 15



14994

(N804837S)
Black Nylon

Push-Type Retainer
Head Diameter: 1" (25.4mm)
Stem Length: 29/32" (23mm)
Fits into 1/4" (6.4mm) Hole
Ford 1987 - On

UNIT PACKAGE: 50



18310

(22587036)
Black Nylon

Rear Bumper Fascia Push-Type Retainer
Head Diameter: 1" (25.4mm)
Stem Length: 15/16" (24mm)
Fits into 3/8" (9.5mm) Hole
Chevrolet Cavalier & Pontiac Sunfire 1995 - On

UNIT PACKAGE: 25



15702

(14101262)
Black Nylon

Plastic Cover on Engine Compartment Retainer
Head Diameter: 1" (25.4mm)
Shoulder Length: 1/8" (3.2mm)
Stem Length: 15/16" (24mm)
Fits into 1/2" (12.7mm) Hole
Buick, Oldsmobile & Pontiac 1988 - On

UNIT PACKAGE: 25



20265

(25663903)
Black Nylon

Radiator Support Sight Shield Push-Type Retainer
Head Diameter: 1" (25.4mm)
Stem Length: 1" (25.4mm)
Fits into 1/4" (6.4mm) Hole
Cadillac DeVille & Seville 1998 - On

UNIT PACKAGE: 10

PUSH-TYPE RETAINERS

Refer to Retainer Specification Chart on pages 571-581

Listed smallest to largest by Head Diameter, Stem Length and then by Hole Diameter.



18503

(W701054-S300)
Black Nylon

Front Bumper Push-Type Retainer
Head Diameter: 1" (25.4mm)
Stem Length: 1" (25.4mm)
Fits into 5/16" (8mm) Hole
Ford Contour & Mystique 1995 - On

UNIT PACKAGE: 25

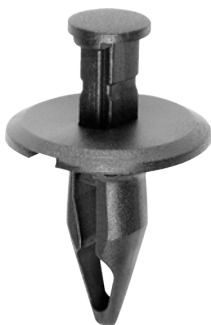

15044

(22535007)
Black Nylon

Bumper Fascia Retainer
Head Diameter: 1" (25.4mm)
Shoulder Length: 1/8" (3.2mm)
Stem Length: 1" (25.4mm)
Fits into 1/2" (12.7mm) Hole
GM 1987 - On

UNIT PACKAGE: 25



15045

(10053388, 22542705)
Black Nylon

Bumper Fascia Retainer
Head Diameter: 1" (25.4mm)
Shoulder Length: 1/8" (3.2mm)
Stem Length: 1-7/64" (28.2mm)
Fits into 1/2" (12.7mm) Hole
GM 1987 - On

UNIT PACKAGE: 25



18394

(6503453)
Black Nylon

Bumper Fascia Retainer
Head Diameter: 1" (25.4mm)
Stem Length: 1-1/8" (28.5mm)
Fits into 1/4" (6.4mm) Hole
Jeep Grand Cherokee 1994 - On

UNIT PACKAGE: 25



15042

(10077283)
Black Nylon

Bumper Fascia Retainer
Head Diameter: 1" (25.4mm)
Shoulder Length: 1/4" (6.4mm)
Stem Length: 1-1/8" (28.5mm)
Fits into 1/2" (12.7mm) Hole
GM 1982 - On

UNIT PACKAGE: 25



18268

(15959832)
Black Nylon

Front License Plate Bracket Push-Type Retainer
Head Diameter: 1" (25.4mm)
Shoulder Length: 9/64" (3.6mm)
Stem Length: 1-5/8" (41.3mm)
Fits into 1/2" (12.7mm) Hole
GM Truck 1994 - On

UNIT PACKAGE: 5



18334

(15959833)
Gray Nylon

Front License Plate Bracket Push-Type Retainer
Head Diameter: 1" (25.4mm)
Stem Length: 1-3/4" (44.5mm)
Fits into 1/2" (12.7mm) Hole
GM S-10 Truck with Decor Package
1994 - On

UNIT PACKAGE: 5



21238

(22718369)
Black Nylon

Fuel Tank Shield & Miscellaneous Push-Type Retainer
Head Diameter: 26mm
Stem Length: 12mm
Fits into 10mm Hole
Chevrolet Malibu & Trail Blazer 2004 - On

UNIT PACKAGE: 25



22762

(Nissan: 62828-AG000)
Black Nylon

Wheel Wind Deflector Push-Type Retainer
Head Diameter: 26mm
Stem Length: 9mm (Excluding Pin)
Fits into 16mm Hole
Nissan Versa 2013 - On

UNIT PACKAGE: 15

PUSH-TYPE RETAINERS

Refer to Retainer Specification Chart on pages 571-581

Listed smallest to largest by Head Diameter, Stem Length and then by Hole Diameter.



19892

(25695687)
Black Nylon

**Radiator Support Sight Shield
Push-Type Retainer**

Head Diameter: 27mm
Shoulder Length: 7mm
Stem Length: 18mm
(Excluding the Pin)
Fits into 10mm Hole

Cadillac DeVille & Seville 2000 - On

UNIT PACKAGE: 15



22502

(Toyota: 76923-52021)
Black Nylon

**Side Mud Guard
Push-Type Retainer**

Head Diameter: 29mm
Stem Length: 10mm
Fits into 22mm Hole
Lexus GS F, GS 200t, GS 350,
GS 450h, IS 200t, IS 250, IS 300,
IS 350, RC F, RC 200t, RC 300
& RC 350 2013 - On
Toyota Yaris 2011 - 2007
Scion xD 2014 - 2008

UNIT PACKAGE: 15



22703

(Honda: 91505-TY2-003)
Black Nylon

Engine Cover Push-Type Retainer

Head Diameter: 30mm
Stem Length: 12mm
Fits into 10mm Hole
Honda Accord, Civic,
Clarity, CR-V & Fit 2017 - On

UNIT PACKAGE: 15



17616

(21077131)
Black Nylon

**Bumper Fascia
Push-Type Retainer**

Head Diameter: 1-3/16" (30mm)
Stem Length: 2" (51mm)
Fits into 7/16" (11mm) Hole
GM Saturn 1991 - On

UNIT PACKAGE: 10



22339

(Mercedes: 001-990-01-92)
Black Nylon

**Rocker Panel Moulding
Push-Type Retainer**

Head Diameter: 30.5mm
T25 Drive

Stem Length: 17mm
Fits into 8.5mm Hole

Mercedes-Benz CLS550, CLS63
AMG, SL550, SL600, SL63 AMG,
SLK300, SLK350 &
SLK55 AMG 2011 - 2008

UNIT PACKAGE: 25



21348

(6508643-AA)
Black Nylon

Tail Light Push-Type Retainer

Top Head Diameter: 31.5mm
Bottom Head Diameter: 20mm
Stem Length: 23mm
Fits into 10mm Hole

Dodge Nitro and Jeep 2008 - On

UNIT PACKAGE: 15



25218

(Chrysler: 68463254AA)
Black Nylon

Grille Push-Type Retainer

Head Diameter: 32mm
Stem Length: 23mm
Fit into 9mm Hole
Jeep Renegade 2015 - On

UNIT PACKAGE: 5



20963

(4806334-AA)
Black & White Nylon

**Rear Bumper Push-Type
Retainer with Sealer**

Head Diameter: 34mm
Shoulder Length: 3.5mm
Stem Length: 17mm
Fits into 8.5mm Hole
Dodge Caliber and
Jeep Compass &
Patriot 2007 - On

UNIT PACKAGE: 10

PUSH-TYPE RETAINERS

Sec. 19

Refer to Retainer Specification Chart on pages 571-581

Listed smallest to largest by Head Diameter, Stem Length and then by Hole Diameter.



19638

(Chrysler: 4805405AA;
Ford: 1L5Z-17K826AA)
Black & White Nylon

**Front Bumper Fascia
Push-Type Retainer**

Head Diameter: 34mm
Shoulder Length: 3mm
Stem Length: 20mm
Fits into 8mm Hole

Chrysler Concorde, Intrepid, Eagle,
Pacifica & PT Cruiser 1998 - On
Ford Trucks 2005 - On

UNIT PACKAGE: 15



22072

(Toyota: 76923-47010)
Black Nylon

**Rocker Moulding
Push-Type Retainer**

Head Diameter: 38mm
Stem Length: 32mm
Fits into 22mm Hole

Lexus HS 250h & CT 200h
and Toyota Prius 2010 - On

UNIT PACKAGE: 5



25319

(BMW: 51-13-1-885-399)
Black Nylon

**Grille & Interior Trim Push-Type
Retainer**

Head Diameter: 7mm x 15mm
Stem Length: 14.5mm
Stem Diameter: 5.7mm x 7.7mm
Fit into 6mm Sq. Primary
& 7mm Secondary Hole
Panel Range: 7mm

BMW 525 2007 - 2001, 528 2010 - 2008, 530 2007 - 2001,
535 2010 - 2008, 540 2003 - 1994, 545, 645 2005 - 2004,
550, 650, M6 2010 - 2006, 735 1992 - 1988,
740 2001 - 1993, 750 2001 - 1988, M5 2010 - 2000,
X5 2006 - 2000, Z3 2002 - 1996

UNIT PACKAGE: 25



16725

(66814-01G00)
Black Nylon

Cowl Grille Retainer

Head Size: 8mm x 12mm
Stem Length: 8mm
Fits into 6mm Square Hole
Nissan Pick-Up 1986 - On

UNIT PACKAGE: 25



20923

(Ford: 3M8Z-1502316-A;
Mazda: GJ6E-50-715A)
Black Nylon

Cowl Vent Push-Type Retainer

Head Size: 8.5mm x 12mm
Stem Length: 9mm
Fits into 5mm Hole
Ford Fusion, Milan & Zephyr 2006 - On
Mazda 5 & 6 2003 - On

UNIT PACKAGE: 15



20407

(9133073-8)
Black Nylon

**Hood Insulation & Radiator Seal
Push-Type Retainer**

Head Size: 8mm x 25mm
Stem Length: 10mm
Fits into 5mm Hole
Volvo 850, 940, 960, S80, S90 & V90 1991 - On

UNIT PACKAGE: 25



20203

(124-990-07-92)
Black Nylon

Push-Type Retainer

Head Size: 11mm x 14mm
Stem Length: 8mm
Fits into 7mm x 8mm Hole
Mercedes-Benz 124, 129, 140, 170, 202, 203,
208, 210, 215 & 220 1986 - On

UNIT PACKAGE: 25



14953

(Ford: N803494S; GM: 15679091)
Black Nylon

Fascia, Trim & Grille Retainer

Head Size: " 15/32" x 15/32"
(12mm x 12mm)
Stem Length: 21/32" (16.7mm)
Fits into 1/4" (6.4mm) Square Hole or Slot
Ford Aerostar, Escort & Lynx 1985 - On
GM 1994 - On

UNIT PACKAGE: 25



25420

(BMW: 51-71-8-195-811)
Black Nylon

Cowl Vent Push-Type Retainer

Head Diameter: 11mm x 18mm
Stem Length: 13.5mm
Stem Diameter: 9mm
Fit into 8mm Hole
Panel Range: 4mm Max
BMW 740, 750 2001 - 1995, X4 2018 - 2015

UNIT PACKAGE: 25

PUSH-TYPE RETAINERS

Refer to Retainer Specification Chart on pages 571-581

Listed smallest to largest by Head Diameter, Stem Length and then by Hole Diameter.



14727

(Nissan: 63844-D0100;
Isuzu: 8942211500)
Black Nylon

Push-Type Retainer

Head Size: 14mm x 22mm
Stem Length: 9mm
Fits into 7mm Hole
Isuzu & Nissan

UNIT PACKAGE: 25



22397

(VW: 1K0-837-199B; 8L3837199B;
811807447; 8L4833052;
8L4833051 8L837199)
Black Nylon

Front Door Push-Type Retainer

Top Head Diameter: 10mm
Bottom Head Size: 10mm x 22mm
Stem Length: 12mm
Fits into 7mm Hole

Audi A3, A4, A6, A7, A8, RS 4,
RS 6 & TT and Volkswagen Golf & Jetta 2011 - 1996

UNIT PACKAGE: 15



20892

(12337831)
Black Nylon

Front Bumper Push-Type Retainer

Head Size: 14mm x 26mm
Stem Length: 14mm
Fits into 8mm Hole
Pontiac G6 2005 - On

UNIT PACKAGE: 50



14008

(14032200)
Black Nylon

Grille Attachment Retainer

Head Size: 19/32" x 3/4"
(15mm x 19mm)
Stem Length: 19/32" (15mm)
Fits into 5/16" (8mm) Hole
GM 1981 - On

UNIT PACKAGE: 25



16843

(Mazda: BF82-50-233;
Nissan: 01553-01393)
Black Nylon

**Bumper Cover
Push-Type Retainer**

Head Size: 20mm x 30mm
Stem Length: 18mm
Fits into 10mm Hole
Mazda & Nissan

UNIT PACKAGE: 10



20890

(55157112-AA, 55157112-AB)
Black & Natural Nylon

**Bumper Cover
Push-Type Retainer**

Head Size: 25mm x 45mm
Shoulder Length: 3mm

Stem Length: 20mm
Fits into 9.5mm Hole
Jeep Liberty 2005 - On

UNIT PACKAGE: 15



25058

(Mercedes: 000-991-21-95)
Black Nylon

**Radiator Upper Insulator
Push-Type Retainer**

Head Diameter: 30mm
Flange Size: 23mm x 40mm
Stem Diameter: 11mm
Stem Length: 22mm
Fits into 11mm Hole

Mercedes C300 2008 - On; C43 AMD 2017 - On;
C250 2015 - 2012; C350 2018 - 2008; C400 2015;
C450 AMG 2016; C63 AMG 2008 - On; CL550,
CL600 2014 - 2007; CL63 AMG, CL65 AMG 2014 - 2008;
CLS400 2016 - On; CLS53 AMG 2019 - On; CLS55 AMG
2006; CLS550 2018 - 2007; CLS63 AMG 2018 - 2007;
E250 2016 - 2014; E300 2019 - 2017; E320 2009 - 2007;
E350 2016 - 2007; E400 2018 - 2013; E43 AMG 2018 - 2017;
E450 2019; E53 AMG 2019; E550 2017 - 2007;
E63 AMG 2019 - 2007; GLC300 2019 - 2016;
GLC350e 2019 - 2019; GLC43 AMG 2019 - 2017;
GLK63 AMG 2019 - 2018; GLK250 2015 - 2013; GLK 350
2015 - 2010; S350 2013 - 2012; S400 2013 - 2010;
S550, S600 2013 - 2007; S63 AMG 2013 - 2008;
S65 AMG 2013 - 2007

UNIT PACKAGE: 10

PUSH-TYPE RETAINER SPECIFICATION CHART



Auveco Part No.	Type	Head Diameter	Stem Length	Fits Hole Size	Shoulder Length	Color	Page No.
11699	7	11/16" (17.5mm)	5/8" (16mm)	1/4" (6.4mm)		Black	539
11704	7	11/16" (17.5mm)	7/16" (11mm)	9/32" (7.1mm)		Black	539
11705	7	19/32" (15mm)	5/8" (16mm)	1/4" (6.4mm)		Black	533
11706	7	3/4" (19mm)	11/16" (17.5mm)	1/4" x 1/4" (6.4mm x 6.4mm)	1/4" (6.4mm)	Black	548
12567	5	11/16" (17.5mm)	9/16" (14.3mm)	1/4" (6.4mm)		Black	504
12756	5	1" (25.4mm)	7/8" (22mm)	1/2" (12.7mm)	1/4" (6.4mm)	Brown	539
12757	5	1" (25.4mm)	3/4" (19mm)	1/2" (12.7mm)	1/8" (3.7mm)	Black	565
13230	7	10mm	7mm	5mm		Black	524
13457	1 (Phillips Hex Drive)	43/64" (17mm)	23/32" (18.3mm)	5/16" (8mm)		Black	539
13993	6	11/16" (17.5mm)	7/8" (22mm)	1/4" (6.4mm)		Black	540
13994	6	1" (25.4mm)	7/8" (22mm)	5/16" (8mm)		Black	565
13996	6	11/16" (17.5mm)	7/8" (22mm)	9/32" (7.1mm)		Black	540
13999	3	3/8" (9.5mm)	1/2" (12.7mm)	7/32" (5.6mm)		Black	524
14001	5	21/32" (16.7mm)	19/32" (15mm)	5/16" (8mm)		Black	537
14007	5	11/16" (17.5mm)	9/16" (14.3mm)	1/4" (6.4mm)		Black	539
14008	11	19/32" x 3/4" (15mm x 19mm)	19/32" (15mm)	5/16" (8mm)		Black	569
14010	5	1" (25.4mm)	23/32" (18.3mm)	3/8" (9.5mm)		Black	564
14011	5	21/32" (16.7mm)	9/16" (14.3mm)	5/16" (8mm)		Black	537
14016	3	3/8" (9.5mm)	7/16" (11mm)	3/16" (4.8mm)		Black	524
14018	3	18mm	23mm	7mm		Black	546
14019	6	1" (25.4mm)	7/8" (22mm)	5/16" (8mm)	1/8" (3.2mm)	Black	565
14020	6	1" (25.4mm)	7/8" (22mm)	1/4" (6.4mm)		Black	565
14147	6	1" (25.4mm)	7/8" (22mm)	1/4" (6.4mm)		Black	565
14260	1	15mm	12mm	7mm		Black	532
14369	1	20mm	9mm	6mm		Black	550
14696	1	15mm	11mm	6mm		Black	531
14697	1	14mm	11mm	7mm		Black	529
14698	1	18mm	11mm	6mm		Black	542

*Not including the pin

PUSH-TYPE RETAINER SPECIFICATION CHART



Auveco Part No.	Type	Head Diameter	Stem Length	Fits Hole Size	Shoulder Length	Color	Page No.
14726	1	17mm	18mm	8mm		Black	538
(Phillips Hex Drive)							
14727	10	14mm x 22mm	9mm	7mm		Black	569
14753	2	1 1/16" (17.5mm)	7/8" (22mm)	1/4" (6.4mm)		Black	540
14953	10	15/32" x 15/32" (12mm x 12mm)	21/32" (16.7mm)	1/4" x 1/4" (6.4mm x 6.4mm)		Black	568
14987	2	11mm (7/16")	18mm (11/16")	6mm (15/64")		Black	526
14988	2	7/16" (11mm)	11/16" (17.5mm)	15/64" (6mm)		Black	526
14990	2	7/16" (11mm)	15/32" (11.9mm)	15/64" (6mm)		Black	526
(Torx Drive)							
14991	2	1 1/16" (17.5mm)	1 1/16" (17.5mm)	1/4" (6.4mm)		Black	539
14992	2	19/32" (15mm)	29/32" (23mm)	1/4" (6.4mm)		Black	534
14993	2	1 1/16" (17.5mm)	7/8" (22mm)	1/4" (6.4mm)		Black	540
14994	2	1" (25.4mm)	29/32" (23mm)	1/4" (6.4mm)		Black	565
14995	2	1/2" (12.7mm)	1-13/64" (30.5mm)	9/32" (7mm)		Black	528
14997	2	19/32" (15mm)	13/16" (20.6mm)	5/16" (8mm)		Black	534
14998	2	27/32" (21.4mm)	1" (25.4mm)	13/32" (10.3mm)		Black	560
15042	6	1" (25.4mm)	1-1/8" (28.5mm)	1/2" (12.7mm)	1/4" (6.4mm)	Black	566
15043	6	7/8" (22mm)	1-3/64" (26.5mm)	1/2" (12.7mm)	5/32" (4mm)	Black	562
15044	6	1" (25.4mm)	1" (25.4mm)	1/2" (12.7mm)	1/8" (3.2mm)	Black	566
15045	6	1" (25.4mm)	1-7/64" (28.2mm)	1/2" (12.7mm)	1/8" (3.2mm)	Black	566
15522	5	5/8" (16mm)	17/32" (13.5mm)	1/4" (6.4mm)		Black	536
15672	1	17mm	14mm	8mm (5/16")		Black	538
(Phillips Hex Drive)							
15701	6	25mm	27mm	7mm		Black	564
15702	6	1" (25.4mm)	15/16" (24mm)	1/2" (12.7mm)	1/8" (3.2mm)	Black	565
16000	1	20mm	9mm	8mm		Black	550
16265	5	1" (25.4mm)	3/4" (19mm)	1/2" (12.7mm)	1/8" (3.2mm)	Black	565
16622	6	18mm	23mm	9.5mm (3/8")		Black	546
16624	3	17mm	18mm	9.5mm (3/8")	2mm	Black	538
16625	6	20mm	20mm	10mm x 10mm		Black	557

*Not including the pin

PUSH-TYPE RETAINER SPECIFICATION CHART



Auveco Part No.	Type	Head Diameter	Stem Length	Fits Hole Size	Shoulder Length	Color	Page No.
16725	11	8mm x 12mm	8mm	6mm x 6mm		Black	568
16726	3	18mm	18mm	6.3mm x 6.3mm		Black	544
16782	8	20mm	8mm*	8mm		Black	555
16783	8	12mm	8mm*	6mm		Black	527
16784	8	18mm	11mm*	7mm		Black	542
16816	3	14mm	14mm	6mm		Black	529
16835	2	27/32" (21mm)	1" (25mm)	1/2" (12mm)	1/8" (3mm)	Black	560
16843	10	20mm x 30mm	18mm	10mm		Black	569
16858	2	25/32" (20mm)	23/32" (18mm)	5/16" (8mm)		Black	557
16859	2	9/16" (14mm)	5/8" (16mm)	1/4" (6mm)		Black	530
17057	2	18mm	21mm	8mm		Black	546
17081	1	18mm	12mm	6mm		Black	542
17103	3	15mm	23mm	6mm		Black	534
17143	2	20mm	27mm	10mm		Black	560
17144	2	20mm	24mm	10mm		Black	559
17162	8	15mm	8mm*	6.3mm		Black	532
17192	4	18mm	14mm	8mm		Black	543
17206	1	15mm	12mm*	9mm		Black	532
17214	2 (Torx Drive)	7/16" (11mm)	11/16" (18mm)	15/64" (6mm)		Black	526
17216	3	20mm	20mm	8mm		Black	557
17222	3	15mm	20mm	8mm		Black	534
17226	3	15mm	29mm	8mm		Black	535
17227	7	7mm	10mm	5mm		Black	524
17267	1	20mm	15mm	10mm		Black	556
17287	1	13mm	11mm	6mm		Black	528
17347	8	20mm	11mm*	8mm		Black	552
17350	1 (Phillips Hex Drive)	20mm	15mm	8mm		Black	556
17351	1	17mm	10mm	7mm		Black	538
17378	1	22mm	14mm*	8mm		Black	561
17379	1	20mm	9mm	8mm		Black	551
17383	8	11mm	14mm*	7mm		Black	526
17439	2	15mm	27mm	9mm		Black	535
17472	2	20mm	20mm	8mm		Black	557
17478	3	14mm	16mm	6mm		Black	530
17616	6	1-3/16" (30mm)	2" (51mm)	7/16" (11mm)		Black	567
17632	1	18mm	12mm	8mm		Black	542
17988	2	19mm	26mm	9mm		Black	548
17992	1	20mm	12mm	7mm		Black	552
18030	6	11/16" (17.5mm)	13/16" (20.6mm)	1/4" (6.4mm)		Black	539
18032	2	15/32" (11.9mm)	9/16" (14.3mm)	1/4" (6.4mm)		Black	526

*Not including the pin

PUSH-TYPE RETAINER SPECIFICATION CHART



Auveco Part No.	Type	Head Diameter	Stem Length	Fits Hole Size	Shoulder Length	Color	Page No.
18119	1	20mm	25mm	10mm		Black	559
18165	4	17mm	9mm	8mm		Black	538
18206	4	18mm	12mm	6mm		Gray	542
18265	6	16mm	20mm	8mm		Black	537
18268	6	1"	1-5/8"	1/2"	9/64"	Black	566
		(25.4mm)	(41.3mm)	(12.7mm)	(3.6mm)		
18269	5	7/8"	1"	1/4"		Black	562
		(22mm)	(25.4mm)	(6.4mm)			
18270	8	17mm	9mm	7mm		Black	538
18308	3	3/4"	1-1/8"	1/4"		Black	549
		(19mm)	(28.5mm)	(6.4mm)			
18310	6	1"	15/16"	3/8"		Black	565
		(25.4mm)	(24mm)	(9.5mm)			
18327	5	11/16"	5/8"	1/4"		Black	539
		(17.5mm)	(16mm)	(6.4mm)			
18334	6	1"	1-3/4"	1/2"		Gray	566
		(25.4mm)	(44.5mm)	(12.7mm)			
18353	9	9/16"	41/64"	1/4"		White	530
		(14.3mm)	(16.3mm)	(6.4mm)			
18394	3	1"	1-1/8"	1/4"		Black	566
		(25.4mm)	(28.5mm)	(6.4mm)			
18503	6	1"	1"	5/16"		Black	566
		(25.4mm)	(25.4mm)	(8mm)			
18873	3	18mm	28mm	9mm		Black	547
18888	4	20mm	8mm*	7mm		Black	550
18893	1	11/16"	1/2"	1/4"		Black	539
		(17.5mm)	(12.7mm)	(6.4mm)			
18894	1	11/16"	3/4"	1/4"		Black	539
		(17.5mm)	(19mm)	(6.4mm)			
18895	1	11/16"	1-3/32"	1/4"		Black	540
		(17.5mm)	(28mm)	(6.4mm)			
18896	3	20mm	28mm	8mm		Black	560
18939	2	18mm	23mm	9mm		Black	546
18951	1	20mm	26mm	8mm		Black	559
19013	4	15mm	10mm	7mm		Black	531
19118	4	20mm	10mm	8mm		Black	551
19128	1	20mm	9mm	7mm		Black	550
19140	1	20mm	21mm	8mm		Black	558
19142	1	15mm	13mm	7mm x 7mm		Black	533
19186	4	11mm	10mm	8mm		Black	525
19195	7	16mm	12mm	8mm		Black	536
19219	Misc.	15mm	27mm	9mm		Black	535
19231	8	18mm	12mm	8mm		Black	544
19232	1	17mm	13mm	7mm		Black	538
19233	4	20mm	13mm	10mm		Black	554
19239	4	20mm	11mm	8mm		Black	552
19244	6	1"	11/16"	1/4" x 1/4"		Black	564
		(25.4mm)	(17.5mm)	(6.4mm x 6.4mm)			

*Not including the pin

PUSH-TYPE RETAINER SPECIFICATION CHART



Auveco Part No.	Type	Head Diameter	Stem Length	Fits Hole Size	Shoulder Length	Color	Page No.
19245	3	3/4" (19mm)	1-1/8" (28.5mm)	1/4" (6.4mm)		Black	549
19246	4	18mm	15mm	10mm		Black	544
19248	7	16mm	14mm	6mm		Black	536
19274	4	20mm	9mm*	8mm		Black	551
19297	8	16mm	12mm*	7mm		Black	536
19306	1	16mm	12mm	6mm		Black	536
19311	1	15mm	13mm	6mm		Black	533
19315	1	20mm	9mm*	8mm		Black	551
19337	Misc.	14mm	23mm	6.3mm		Black	530
19355	6	17/32" (13.5mm)	1-5/64" (27.5mm)	1/4" (6.4mm)		Black	529
19407	2	20mm	27mm	10mm		Black	560
19408	2	20mm	24mm	10mm		Black	559
19416	8	18mm	12mm*	9mm		Black	544
19422	4	23/32" (18.3mm)	29/32" (23mm)	5/16" (8mm)		Black	547
19453	4	18mm	15mm*	8mm		Black	544
19490	1	18mm	8mm	6mm		Black	540
19511	9	29/32" (23mm)	11/16" (17.5mm)	3/8" (9.5mm)		White	534
19522	3	12mm	18mm	6mm x 6mm		Black	528
19546	1	17mm	16mm	7mm x 7mm		Black	538
19547	4	17mm	13mm*	9mm		Black	538
19552	1	16mm	9mm	7mm		Black	535
19607	7	16mm	12mm	10mm		Natural	536
19615	3	20mm	21mm	9mm		Black	558
19638	Misc.	34mm	20mm	8mm	3mm	Black & White	568
19639	3	17mm	16mm	6mm		Black	538
19645	1	14mm	8mm*	6mm		Gray	529
19726	1	14mm	8mm*	6mm		Black	529
19739	2	20mm	26mm	9mm		Black	559
19747	1	18mm	10mm	8mm		Black	541
19787	2	12mm	17mm	6mm		Black	527
19788	2	11mm	20mm	6mm		Black	526
19801	3	19/32" (15mm)	3/4" (19mm)	1/4" (6.4mm)		Black	534
19847	5	7/8" (22mm)	25/32" (20mm)	1/2" (12.7mm)	5/32" (4mm)	Blue	562
19849	2	18mm	18mm	8mm		Black Nylon & Santoprene Rubber	545
19892	8	27mm	18mm*	10mm	7mm	Black	567
19904	7	16mm	14mm	9mm		Black	537
19905	1	20mm	8mm*	8mm		Black	550
19907	1	20mm	8mm*	7mm		Gray	549
19908	1	20mm	8mm*	7mm		Black	549
20169	9	15mm	13mm	7mm		White	533
20187	7	10mm	10mm	6mm		Black	525

*Not including the pin

PUSH-TYPE RETAINER SPECIFICATION CHART



Auveco Part No.	Type	Head Diameter	Stem Length	Fits Hole Size	Shoulder Length	Color	Page No.
20196	1	14mm	8mm	6mm		Black	529
20203	Misc.	11mm x 14mm	8mm	7mm x 8mm		Black	568
20233	8	25mm	12mm*	9mm	3mm	Black	563
20234	5	15mm	15mm	6.3mm		Black	533
20244	9	19mm	32mm	8mm		Green with Sealer	549
20247	4	18mm	12mm	9mm		Black	542
20248	5	20mm	17mm	6.3mm		Black	557
20265	2	1" (25.4mm)	1" (25.4mm)	1/4" (6.4mm)		Black	565
20270	5	20mm	9mm	7mm		Black	550
20273	8	19mm	22mm	9mm	7mm	Gray	548
20310	7	5/8" (16mm)	7/16" (11mm)	1/4" (6.4mm)		Black	535
20314	7	13mm	14mm	8mm		Black	528
20327	4	18mm	22mm	9mm		Black	546
20335	4	18mm	7mm	7mm		Black	540
20348	2	20mm	22mm	8mm		Black	559
20349	4	18mm	12mm	8mm		Black	542
20352	2 (Slotted Drive)	16mm	21mm	8mm		Black	537
20359	6	18mm	26mm	10mm		Black	547
20363	9	20mm	12mm*	9mm		White	532
20365	4	18mm	13mm	7.5mm x 7.5mm		Black	543
20367	2	18mm	18mm	8mm		Black	545
20388	1	20mm	16mm	7mm		Black	556
20407	11	8mm x 25mm	10mm	5mm		Black	568
20457	3	21mm	23mm	9.5mm		Black	560
20458	6	20mm	17mm	7mm		Black	557
20465	1	18mm	9mm	8mm		Black	540
20516	1 (Hex Drive)	20mm	13mm	8mm		Black	554
20542	6	16.5mm	27mm	8mm		Black	537
20545	2	18mm	18mm	6.3mm		Black Nylon & Santoprene Rubber	544
20564	4	20mm	18mm	10mm		Black	557
20577	1	20mm	8mm*	7mm		Black	549
20580	4	14mm	12mm	7mm		Black	532
20608	4	20mm	14mm	10mm		Black	555
20613	2	18mm	20mm	9mm		Black	545
20631	6	18mm	26mm	10mm		Black	547
20632	3	20mm	26mm	8mm		Black	559
20636	5	12mm	10mm	8.5mm		Dark Gray	527
20637	5	20mm	9mm	8mm		Black	551
20638	5	20mm	14mm	8.5mm		Black	555
20639	1	12mm	11mm	5mm x 5mm		Black	527
20640	1	12mm	11mm	5mm		Black	527
20734	7	20mm	15mm	6.3mm		Black	558
20739	8	22mm	10mm*	9mm		Black	561

*Not including the pin

PUSH-TYPE RETAINER SPECIFICATION CHART



Auveco Part No.	Type	Head Diameter	Stem Length	Fits Hole Size	Shoulder Length	Color	Page No.
20753	2	22mm	21mm	8mm		Black	562
20755	4	19.5mm	15mm	10mm		Black	549
20766	7	20mm	16mm	10mm		Black	556
20768	4	18.5mm	21mm	8mm		Black with Sealer	547
20826	3	19mm	14mm	8.5mm		Black	548
20863	4	22mm	13mm*	15mm		Black	561
20869	4	18mm	7.5mm	7mm		Black	540
20880	3	18mm	20mm	6.5mm		Black	545
20888	3	18mm	20mm	9.5mm		Black	546
20889	3	20mm	22mm	8.5mm		Black	558
20890	Misc.	25mm x 45mm	20mm	9.5mm	3mm	Black & Natural	569
20892	10	14mm x 26mm	14mm	8mm		Black	569
20908	4	20mm	10mm	7mm		Black	551
20909	6	16mm	18mm	7mm		Black	537
20923	10	8.5mm x 12mm	9mm	5mm		Black	568
20931	3	18mm	31mm	9mm		Black	547
20943	2	14mm	23mm	7mm		Black	530
20948	8	22mm	10mm*	9mm		Tan	561
20953	4	20mm	13mm	8mm		Black	553
20963	Misc.	34mm	17mm	8.5mm	3.5mm	Black & White	567
20966	4	18mm	20mm	8mm		Black	545
20967	7	22mm	16mm	10mm		Black	562
20986	4	20mm	13mm	10mm		Black	554
20988	3	18mm	17.5mm	6.5mm		Black	544
20989	3	18mm	22mm	6.5mm		Black	546
20990	3	19mm	16mm	8mm		Black	548
20991	3	20mm	20mm	8.5mm		Black	557
20992	3	20mm	24mm	8.5mm		Black	559
20993	3	25mm	20mm	10.5mm		Black	564
20994	3	25mm	23mm	10.5mm		Black	564
21010	1	20mm	9mm	9mm x 9mm		Black	551
21011	4	15mm	17mm	7mm		Black	534
21021	8	22mm	10mm*	9mm		Gray	561
21024	4	18mm	10mm	6mm		Black	541
21037	7	10mm	10mm	6mm		Black	525
21044	1	16mm	11mm	6.3mm		Black	535
21086	5	20mm	10mm	8mm		Black	551
21089	1	18mm	18mm	8mm		Black	545
21098	1	18mm	18mm	6.4mm		Black	544
21103	1	10mm	12mm	5mm		Gray	525
21104	1	14mm	14mm	7mm		Black	529
21110	8	18mm	12mm	8.5mm		Black	542
21112	2	15mm	14mm	6mm		Black	533
21119	2	20mm	19mm	6mm		Black	557
21120	8	15mm	9mm*	7mm		Black	533
21123	4	18mm	12mm*	8mm		Black	545
21134	8	20mm	11mm*	8mm		Black	555
21140	8	15mm	12mm	6.3mm		Black	532

*Not including the pin

Sec. 19

PUSH-TYPE RETAINER SPECIFICATION CHART



Auveco Part No.	Type	Head Diameter	Stem Length	Fits Hole Size	Shoulder Length	Color	Page No.
21141	9	18mm	13mm	8mm		Black & White	543
21146	1	18mm	12mm	8mm		Black	542
21172	1	13mm	18mm	8mm		Black With Sealer	529
21173	4	20mm	16mm	10mm		Black	556
21176	Misc.	24.5mm	13mm*	9mm		Black	563
21190	8	16mm	14mm	7mm		Black	537
21192	4	20mm	12mm	8mm		Black	553
21201	4	19mm	8mm	7mm		Black	547
21218	1	11mm	8mm	5mm		Black	525
21225	5	18mm	14mm	7mm		Black	543
21233	2	10mm	13mm	5mm		Black	525
21238	7	26mm	12mm	10mm		Black	566
21246	8	12mm	14mm*	6mm		Black	527
21249	8	11mm	9mm*	7mm		Black	526
21251	Misc.	22.5mm	8mm*	8mm		Black & White	563
21294	4	20mm	9mm	7mm		Black	550
21297	4	20mm	11mm	10mm		Black	552
21311	1	18mm	12mm	8mm		Gray	542
21325	1	16mm	14mm	7mm		Black	537
21328	8	15mm	10mm	7mm		Black	531
21348	Misc.	20mm	23mm	10mm		Black	567
21361	6	25mm	29mm	7mm		Black	564
21366	4	22mm	15mm*	9mm		Black	562
21376	Misc.	24mm	20mm	11mm	3mm	Black & White	563
21391	7	12mm	11mm	8mm		Dark Gray	527
21420	4	21mm	15mm*	10mm		Black	560
21422	4	20mm	9mm*	7mm		Black	550
21427	8	22mm	10mm*	9mm		Gray	561
21477	8	16mm	14mm	7mm		Gray	537
21479	1	18.5mm	11mm	9mm		Gray	547
	(Allen Drive)						
21482	1	24mm	13mm	9mm x 9mm		Black	563
21500	1	20mm	12mm	7mm		Black	553
	(Slotted Drive)						
21501	4	25mm	12mm*	11mm	3mm	Black with Sealer	563
21525	8	19mm	9mm	7mm		Black	547
21529	3	18mm	22mm	6.5mm		Black with Sealer	546
21530	1	18mm	10mm	8mm		Black	541
21545	1	20mm	15mm	8mm		Black	556
21547	4	18mm	10mm	9mm		Black	542
21563	4	20mm	15mm	10mm		Black	556
21566	1	16mm	13mm	7mm		Black	536
21568	Misc.	14mm	15mm	10mm		Black	549
21570	1	16mm	11mm	6mm		Black	535
21571	1	20mm	10mm	8mm		Black	551
21576	4	25mm	16mm*	11mm	3mm	Black with Sealer	564
21578	2	22mm	28mm	10mm		Black	562
21580	1	20mm	12mm	7mm		Black	552

*Not including the pin

PUSH-TYPE RETAINER SPECIFICATION CHART



Auveco Part No.	Type	Head Diameter	Stem Length	Fits Hole Size	Shoulder Length	Color	Page No.
21585	5	9mm	7mm	4mm		Black	524
21592	1 (Slotted Drive)	20mm	11mm	7mm		Black	552
21593	1	15mm	8mm	7mm		Black	530
21594	1	20mm	11mm	7mm		Black	552
21596	4	20mm	16mm	8mm		Black	556
21601	9	22mm	16mm	9mm		White Nylon & Black Rubber Seal	536
21620	2	15mm	14mm	5mm		Black	533
21624	1	16mm	10mm	8mm		Black	535
21631	4	20mm	8mm*	8mm		Black	550
21645	7	15mm	15mm	6.3mm		Black	533
21651	4	20mm	10mm	8mm		Black	551
21658	4	15mm	11mm	6mm		Black	531
21662	8	11mm	11mm	7mm		Black	525
21663	1	10mm	9mm	5mm		Black	524
21672	6	18mm	20mm	6.3mm		Black with Sealer	545
21680	4	18mm	10mm	8mm		Black	541
21702	4	18mm	12mm	10mm		Black	543
21703	Misc.	18mm	12mm	7mm		Black	542
21706	8	20mm	14mm	10mm		Black	555
21711	6	11mm	16mm	6mm		Black Nylon & Santoprene Rubber	526
21778	5	20mm	21mm	8.5		Black	558
21779	7	10mm	11mm	6.3mm		Black	525
21780	7	9mm	7mm	5mm		Black	524
21849	4	13mm	15mm	5.5mm		Black	528
21856	4	20mm	12mm	10mm		Black	553
21858	5	18mm	14mm	6mm		Black	543
21860	4	22mm	14mm	13mm		Black	561
21875	5	12.5mm	9mm	6mm		Black	528
21882	5	12mm	14mm	6mm		Black	527
21935	4	12mm	10mm	6mm		Black	527
21990	5	15mm	8mm	7mm		Black	531
22039	4	16mm x 19mm	12mm	8mm		Black	553
22047	4	25mm	9mm*	8mm		Gray & Black	563
22049	2	18mm	20mm	9mm		Black	546
22052	5	20mm	17mm	6.3mm		Black	557
22058	8	14mm	9mm	7mm		Black	529
22068	4	20mm	13mm	8.5mm		White	554
22069	4	20mm	13mm	8.5mm		White	554
22072	4	38mm	32mm	22mm		Black	568
22077	1	18mm	9mm	9mm		Black	541
22083	4	16mm	10mm	8mm		Black	535
22095	7	22mm	13mm	8mm		Black	561
22100	4	20mm	12mm	8.5mm		Black	553
22101	7	22mm	12mm	7.5mm		Black	561
22112	4	20mm	13mm	8.5mm		Black	554

*Not including the pin

PUSH-TYPE RETAINER SPECIFICATION CHART



Auveco Part No.	Type	Head Diameter	Stem Length	Fits Hole Size	Shoulder Length	Color	Page No.
22125	4	10mm	10mm	5mm		Black	524
22126	6	19mm	28mm	9mm		Black	548
22155	7	13mm	13mm	8mm		Black	528
22160	8	15mm	10mm	7mm		Black	531
22177	Misc.	16mm	13mm	9mm		Yellow & White	536
22181	4	18mm	10mm	8mm		Black	541
22199	1	15mm	12mm	6.3mm		Black	532
22201	5	12.5mm	12mm	8.5mm		Black	528
22219	3	18mm	23mm	7.5mm		Black	546
22227	3	18mm	20mm	7mm		Black	545
22230	8	10mm	8.5mm	5mm		Black	524
22238	5	10mm	11mm	5mm		Black	525
22248	5	19mm	12mm	8mm		Black	548
22253	5	18mm	14mm	8mm		Black	543
22256	1	24mm	12mm	12mm		Black	563
22270	4	20mm	10mm	8mm		Black	551
22280	10	15mm	11mm	5mm		Black	531
22282	8	22mm	25mm	8mm		Gray	562
22284	6	25mm	24mm	8.5mm		Black	564
22299	2	20mm	26mm	9.5mm		Black	560
22303	1	12mm	13mm	7mm		Black	527
22306	5	20mm	10mm	8mm		Black	552
22339	1	30.5mm	17mm	8.5mm		Black	567
22347	3	15mm	21mm	8mm		Black	534
22349	3	14mm	18mm	8mm x 11mm		Black	530
22354	3	18mm	18mm	7mm		Black	545
22363	5	21.5mm	14mm	12.5mm		Black	560
22367	1	15mm	10mm	9mm Square		Black	531
22394	9	18mm	13mm	9mm		Metallic/Green	543
22397	3	10mm	12mm	7mm		Black	569
22401	5	15mm	20mm	6mm		Black	534
22419	5	20mm	21mm	10mm		Black	558
22420	5	16mm	12mm	10.5mm		Black	536
22421	5	15mm	11mm	5mm		Black	531
22424	5	20mm	13mm	8mm		Black	555
22446	4	20mm	13mm	10mm		Gray	554
22459	5	20mm		10mm	13.5mm	Black	554
22482	1	18mm	13mm	9mm x 9mm		Black	543
22502	5	29mm	10mm	22mm		Black	567
22515	5	20mm	14mm	8mm		Black	555
22532	8	25mm	11mm	6.5mm		Black	563
22535	2	18mm	36mm			Black	544
22543	2	11mm	20mm	6mm		Black	526
22552	5	16mm	10mm	6mm		Black	531
22567	5	20mm	12mm	7mm		Black	553
22568	4	22mm	15mm	9mm		Black	562
22595	5	18mm	11mm	8mm		Black	541
22596	5	15mm	11mm	8mm		Black	532

*Not including the pin

PUSH-TYPE RETAINER SPECIFICATION CHART



Auveco Part No.	Type	Head Diameter	Stem Length	Fits Hole Size	Shoulder Length	Color	Page No.
22703	5	30mm	12mm	10mm		Black	567
22710	8	19.5mm	15mm	7mm		Black	549
22722	7	22mm	11mm	7.5mm		Black	561
22759	4	16mm	14mm	7mm		Natural	536
22762	8	26mm	9mm*	16mm		Black	566
22765	7	20mm	8.3mm*	8mm		Black	550
22828	11	18mm x 25mm	9mm	8mm		Black	541
22829	5	18mm	13mm	10mm		Black	543
22830	5	17mm	12mm	8mm		Black	528
22848	3	25mm	19mm	8mm		Black	563
22855	5	15.5mm	13mm	8mm		Dark Grey	535
22856	Misc.	20mm	13.4mm	10mm		Black	554
22859	5	15mm	8mm	6.3mm		Black	530
22893	5	20mm	11mm	7mm		Black	552
22894	5	20mm	13mm	8mm		Black	553
23694	7	19mm	10.5mm	7mm		Black	547
23734	7	7/16"	1/2"	1/4"		White	526
23822	2	15mm	14mm	6mm		Black	533
23826	2	17.8mm	22.8mm	6.3mm		Black	539
23738	7	15mm	13mm			Black	530
23891	3	20mm	26.5mm	9mm		Black	560
23899	6	25mm	15mm	8mm		Black	564
23902	11	10mm x 12mm				Black	525
22920	7	12mm	5mm	5mm		Black	527
23935	2	14mm	8mm	6mm		Gray	529
23943	8	18mm	9mm	6.3mm		Grey	541
23954	5	17.8mm	14.2mm	6.3mm		Black	540
23958	8	15mm	20mm	7mm		Black	534
23959	4	20mm	8.5mm	7mm		Black	550
23993	3	20mm	20mm	8.5mm		Black	557
24160	9	15mm		12.7mm		Natural	564
24533	5	10mm	8mm	4mm		Black	524
25031	3	20mm	21mm	8.5mm		Black	559
25058	4	30mm	22mm	11mm		Black	569
25178	2	14mm	18mm	6.3mm		Black	530
25206	2	20mm	20mm	8mm		Black	562
25214	6	20mm	21mm	8.5mm		Black	558
25216	5	20mm	14mm	8.5mm		Black	555
25218	6	32mm	23mm	9mm		Black	567
25222	7	19mm	15mm	8mm		Black	558
25259	4	20mm	13mm	10mm		Black	554
25319	10	7mm x 15mm	14.5mm	6mm Sq.		Black	568
25324	5	20mm	13.4mm	10mm		White	554
25335	5	15mm	11.5mm	5mm		Black	532
25338	11	19mm	17mm	7mm		Black	548
25420	11	11mm x 18mm	13.5mm	8mm		Black	568

*Not including the pin



11243
(343543, 343555,
354076, 362379)

1/4"-28 x 2"
**Headlight Adjusting Screw &
Nut Assembly**
GM 1962-On

UNIT PACKAGE: 10

11244

Same as 11243 except for
unit package quantity

UNIT PACKAGE: 100



11245
(343543, 343555, 354076, 362379)
Nylon

Headlight Adjusting Nut
GM 1962-On

UNIT PACKAGE: 50

23287



1/4"-28 x 1-1/2"
Headlight Adjusting Nut & Screw
GM 1962 - On

UNIT PACKAGE: 25

23724

(9437348)



#12-28 x 1 3/4"
Headlight Adjusting Screw
GM 1976 - On

UNIT PACKAGE: 50

11246

(343543, 354076, 9438150, 15705372)
Zinc



1/4"-28 x 2"
Headlight Adjusting Screw
GM 1962-On

UNIT PACKAGE: 25

23286

(J01973)



Headlight Adjusting Screw
GM 1965 - 1967
Ford 1965 - 1966
Universal for Other Cars

UNIT PACKAGE: 50



10759
(GM: 1600375, 1606642, 1618890;
AMC: SF 400 6204)

1/4"-28 x 1-7/8"
**Headlight Adjusting Screw &
Nut Assembly**
Cadillac & Oldsmobile 1975-On
AMC

UNIT PACKAGE: 10

11470

Same as 10759 except for
unit package quantity

UNIT PACKAGE: 25

11657

Same as 10759 except for
unit package quantity

UNIT PACKAGE: 100

23309

(1606642, 1618890)

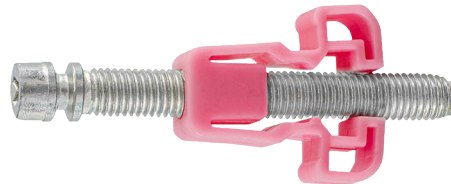

1/4"-28" x 1-7/8"
Headlight Adjusting Nut & Screw
Cadillac 1975 - On
UNIT PACKAGE: 25

23310

(1600375)



1/4"-28 x 1-7/8"
Headlight Adjusting Nut & Screw
Cadillac, Toronado 1971 - On
UNIT PACKAGE: 25



11826

(365270)

Green Nylon

1/4"-28 x 2"
**Headlight Adjusting Screw &
Nut Assembly**
Cars with Fiberglass Panels
GM 1976-On

UNIT PACKAGE: 25



11718
(365270)
Green Nylon
Headlight Adjusting Nut
For Cars with Fiberglass Panels
GM 1976-On

UNIT PACKAGE: 50



11655
(557057, 559312)
Nylon
#12-28 x 1-3/4"
Headlight Adjusting Screw & Nut Assembly
GM 1975-On

UNIT PACKAGE: 25

11656
Same as 11655 except for
unit package quantity

UNIT PACKAGE: 100



12605
(22512857, 22513813)
Nylon
#12-28 x 1-3/4"
Headlight Adjusting Screw & Nut Assembly
Camaro & Firebird 1975-On

UNIT PACKAGE: 10



11871
(559312)
Nylon
#12-28 x 1-11/16"
Headlight Adjusting Screw & Nut Assembly
Chevrolet, Oldsmobile & Pontiac 1975-On

UNIT PACKAGE: 10



9851
(3921446)
White Nylon
Headlight Adjusting Nut
Use with 1/4"-28 Screw
Chevrolet

UNIT PACKAGE: 50



5788
Nylon
Headlight Adjusting Nut
Chevrolet: All Early Models

UNIT PACKAGE: 50



5789
Headlight Adjusting Screw & Nut Assembly
Chevrolet

UNIT PACKAGE: 25 Sets



3209
Zinc
1/4"-28 x 1"
Headlight Adjusting Screw

UNIT PACKAGE: 50



3178
(5949838)

Headlight Adjusting Screw & Nut Assembly
Chevrolet, Buick & Pontiac

UNIT PACKAGE: 10 Sets
WARNING: Reproductive Harm & Cancer
www.P65Warnings.ca.gov



Photo not actual size

19486
(10298115)
Natural Nylon
Headlight Retainer
Width: 1-1/8"
Length: 4-9/16"
Buick Century & Regal and Oldsmobile Intrigue 1997-On

UNIT PACKAGE: 10



10090
(3923948)

**Headlight
Adjusting Spring**
Chevrolet 1968-On

UNIT PACKAGE: 25



15676
(16510893)

Natural Nylon

Composite Headlight Nut
Screw Size: #6
Square Head: 3/8"
Buick Electra (FWD) 1987-On

UNIT PACKAGE: 50



9829
(380382)

Natural Nylon

Headlight Bezel to Body Nut
Screw Size: #6 or #8
GM

UNIT PACKAGE: 50



14002
(16503329)

Black Nylon

Screw Size: #6
Square Head: 3/8"
Fits 1/4" Square Hole
GM

UNIT PACKAGE: 100



11838
(1254815)

Natural Nylon

Screw Size: #6
Panel Range: .060"-.150"
GM 1977-On

UNIT PACKAGE: 50



13450
(347347)

Natural Nylon

Front Lights
Screw Size: #8
Panel Range: 1/16"-5/32"
GM 1967-On

UNIT PACKAGE: 50



10330
(3893980)

Natural Nylon

Front End & Instrument Panel Nut
Screw Size: #8
GM 1967-On

UNIT PACKAGE: 100



11691
(3919773)

Natural Nylon

Headlight Bezel Nut
Screw Size: #8
GM 1974-On

UNIT PACKAGE: 100



11424
(3985058)

Natural Nylon

Truck Grille Nut
Screw Size: #6 or #8
GM Trucks 1974-On

UNIT PACKAGE: 25



11855

(GM: 9669486;
Renault: 8934-201-262)
Natural Nylon

Side Marker Nut
GM 1980-On
Rear License Plate Bracket
Screw Size: #8
AMC/Renault

UNIT PACKAGE: 25



13960
(14013246)

Natural Nylon

Headlight Bezel Nut
Screw Size: #8
Fits into 5/16" Hole
GM 1967-On

UNIT PACKAGE: 50



14031

(12337852, 15596279, 21035018)
Black Nylon

Grille Retainer & Cowl Vent Nut
Screw Size: #8 or #10
Astro, Safari & Saturn 1985-On

UNIT PACKAGE: 25



13933

Natural Nylon

Grille Nut
Screw Size: #8 or #10
Head Size: 1/2"

UNIT PACKAGE: 50



12735

(GM: 1370853; Chry: 6029501;
VW: 179-813-883)
Natural Nylon

Headlight Bezel Nut
Screw Size: #6
GM, Chrysler & VW 1982-On

UNIT PACKAGE: 50



10305

Natural Nylon

Nylon Nut
Screw Size: #8

UNIT PACKAGE: 50



9069

(1355003)

Natural Nylon

Headlight Door to Radiator Grille Anchor Nut

Screw Size: #6 or #8
Buick 1964-On

UNIT PACKAGE: 50



14030

(GM: 3997391; VW: 179-813-881)

Black Nylon

Tail Light Nut

Screw Size: #8
GM Astro & Safari 1985-On
Volkswagen

UNIT PACKAGE: 25



22372

(GM: 25832258)

Black Nylon

Bumper, License Plate & Tail Light Screw Grommet with Sealer

Screw Size: #14 (1/4")
Head Size: 16mm x 16mm
Stem Length: 8mm
Fits into 10mm Square Hole
Buick Enclave, Cadillac CT6,
Chevrolet Traverse, GMC Acadia
& Saturn Outlook 2007 - On

UNIT PACKAGE: 10



21347

(10351052)

White Nylon

Trim Panel Grommet with Sealer

Head Size: 12mm x 14.5mm
Stem Length: 15mm
Fits into 7mm Hole

Mates with Auveco 21346
Cadillac, Chevrolet Camaro &
Corvette and Pontiac Firebird 2004 - On

UNIT PACKAGE: 15



19194

(Toyota: 90189-06028; GM: 94854203)

Black Nylon

Front & Rear Wheel Fender Liner Screw Grommet

Screw Size: #12
Head Diameter: 16mm
Stem Length: 19mm
Fits into 9mm x 9mm Square Hole
Tacoma, T100 & 4 Runner 1992 - On
Chevrolet Nova & Prizm
and Pontiac Vibe 1985 - On

UNIT PACKAGE: 15



17230

(10027015)

Natural Nylon

Screw Grommet for Engine Control Module

Overall Length: 1-3/16"
GM (All Divisions) 1977-On

UNIT PACKAGE: 10



20938

(11561655)

Black Nylon

Tail Light Grommet with Sealer

Head Diameter: 15mm
Stem Length: 17mm
Fits into 11mm Hole
Buick Terraza, Chevrolet Uplander, GMC
Arcadia, Pontiac Montana SV6
and Saturn Relay 2005 - On

UNIT PACKAGE: 5



22911

(GM: 11571225)

Black Elastomer Rubber

Tail Lamp Grommet

Head Diameter: 17mm
Fits into 9.8mm Hole
Overall Height: 16mm
Buick Encore, Envision, Cadillac CTS,
Chevrolet Bolt EV, Equinox, Sonic, Trax, Volt
& GMC Terrain 2010 - On

UNIT PACKAGE: 10



22026

(GM: 25803643)

Natural Nylon

Door Glass to Regulator Grommet

Head Diameter: 13.5mm
Overall Length: 14mm
Buick Allure, LaCrosse & Verano and
Chevrolet Malibu 2010 - On

UNIT PACKAGE: 25



22527

(GM: 90230846, 94515248)

Natural Nylon

Lower Door & Handle Interior Trim Grommet

Screw Size: M4.8 (#10)
Head Size: 9.5mm x 9.5mm
Stem Length: 11mm
Buick Regal 2014 - On
Chevrolet Aveo 2011 - 2009

UNIT PACKAGE: 25



21674
(11570830)
White Nylon

Fog Light Grommet
Head Diameter: 16mm
Stem Length: 16mm
Overall Length: 20mm
Fits into 11mm Hole

Cadillac Escalade, Chevrolet Avalanche, Camaro, Colorado, Silverado & Tahoe and GMC Canyon, Denali, Sierra & Yukon 2005 - On

UNIT PACKAGE: 15



19429
(15954398)
Rubber

Tail Light Screw Grommet
Venture, Silhouette, Transport, S & T Trucks 1995-On

UNIT PACKAGE: 25



20452
(11517873)
Natural Nylon

Screw Grommet
Use with #12 Screw
Head Size: 5/8" x 3/4"
Stem Length: 9/16"
Door Handle

Chevrolet Impala & Monte Carlo 2000 - On

UNIT PACKAGE: 15



21428
(25704358)
White Nylon

Rear Bumper Screw Grommet with Sealer
Screw Size: M6.3 (1/4" or #14)
Head Size: 15mm x 18mm
Stem Length: 23mm
Cadillac CTS & SRX and Pontiac Grand Prix 2004 - On

UNIT PACKAGE: 10



22430
(GM: 22884291)
White Nylon

Tail Light Grommet with Sealer
Head Diameter: 18mm (Including Sealer)
Stem Length: 15mm
Overall Length: 18mm
Fits into 10mm Hole
Cadillac Escalade & GMC Yukon 2015 - On

UNIT PACKAGE: 10



14037
(GM: 15596280; Chry: 6035274)
Black Nylon

Cowl Vent Nut
Screw Size: #6 or #8
GM Astro & Safari 1985-On

UNIT PACKAGE: 25



12713
(GM: 10032838, 1264963;
Chry: 6031869; AMC: 8934-201-602)
Nylon

High Torque Screw Grommet
Screw Size: #6
GM, Chrysler & AMC-Renault 1978-On

UNIT PACKAGE: 25



10365
(1377030)
Natural Nylon

Valance Panel to Rear Bumper Bar Grommet
Screw Size: #6 or #8
GM 1971-On

UNIT PACKAGE: 100



14009
(14032291)
Natural Nylon

Grille Attachment Grommet
Screw Size: #6 or #8

UNIT PACKAGE: 50



25033
(GM: 22761970)
White Nylon

Spoiler Insert Grommet with Sealer
Head Size: 19mm x 25mm
Stem Length: 20mm
Overall Height: 21mm
Fits into 13mm Slot
Chevrolet Camaro 2012 - On;
Malibu 2018 - 2017

UNIT PACKAGE: 25



20466
(GM: 25649667;
Ford: W705590-S300, W710459-S300)
Natural Nylon

Screw Grommet with Sealer
Screw Size: M4.2 (#8)
Head Size: 13mm x 22mm
Stem Length: 18mm
Back Glass Moulding & Interior Trim
Cadillac & Ford Windstar 1998 - On

UNIT PACKAGE: 15



12566
(GM: 25508532; Chry: 6032061)
Black Nylon

Grille Attaching Grommet
Screw Size: #6 or #8
GM & Chrysler 1981-On

UNIT PACKAGE: 25



25193
(GM: 15035237)
White Nylon

Cowl Vent Grommet with Sealer
Head Size: 17mm x 31mm
Stem Length: 16mm
Overall Height: 17mm
Fits into 7mm x 21mm Slot
Chevrolet Express & GMC Savana
Vans 1996 - On; P30 1999 - 1996

UNIT PACKAGE: 10



22835
(GM: 84221533)
Orange Nylon

Tail Lamp Grommet with Sealer
Head Diameter: 19mm
Fits into 10mm Hole
Overall Length: 17.5mm
Cadillac XT5, Chevrolet Silverado
& Traverse and GMC Acadia 2018 - On

UNIT PACKAGE: 10



20635
(GM: 22722860)
White Nylon

Trim Panel Grommet with Sealer
Flange Diameter: 24mm
Stem Length: 12mm
Fits into 9mm Hole
Use with Auveco 20634
Oldsmobile Alero &
Pontiac Grand Am 2002 - On

UNIT PACKAGE: 25



21384
(11561500)
Yellow Nylon

Trim Panel Grommet with Sealer
Flange Diameter: 24mm
Stem Length: 12mm
Fits into 9mm Hole
Use with Auveco 21383
Chevrolet Traverse 2010 - On

UNIT PACKAGE: 25



20527
(15745990)
Black Nylon

**Rear Light Housing
Lower Grommet**
Head Size: 24mm x 24mm
Stem Length: 17mm
Fits into 15mm Hole
GM Bravada, Envoy &
Trailblazer 2002 - On

UNIT PACKAGE: 15



20529
(15745991)
Black Nylon

**Rear Light Housing
Upper Grommet**
Head Size: 13mm x 20mm
Stem Length: 17mm
Fits into 9mm x 16mm Hole
GM Bravada, Envoy & Trailblazer 2002 - On

UNIT PACKAGE: 15



21518
(11561987)
Black Nylon

Tail Light Grommet with Sealer
Head Diameter: 24mm
Stem Length: 22mm
Overall Length: 24.5mm
Cadillac Escalade and Chevrolet Avalanche 2007 - On

UNIT PACKAGE: 15



25051
(GM: 15265199)
Black Nylon

Bumper Cover Grommet
Head Diameter: 28mm
Stem Diameter: 13.3mm
Stem Length: 5mm
Overall Height: 7mm
Hole Diameter: 4.5mm
Buick Enclave 2008 - On;
Envision 2016 - On;
Cadillac Escalade 2018 - 2015; XT4 2019 - On;
XT5 2018 - 2017; XT6 2020 - On;
Chevrolet Blazer 2019 - On; Equinox 2010 - On;
Traverse 2009 - On; Volt 2018 - 2011;
GMC Acadia 2018 - 2007; Terrain 2010 - On;
Yukon 2018 - 2015; Saturn Outlook 2010

UNIT PACKAGE: 25



19613
(15733971)
Black Nylon

**Front Air Deflector
Push-Type Retainer**
Top Head Diameter: 18mm
Bottom Head Diameter: 26mm
Flange Diameter: 30mm
Stem Length: 24mm
Use with Auveco 19614
C & K Trucks 1999 - On;
Express & Savana Vans 2003 - On

UNIT PACKAGE: 15



19614
(15733970)
Black Nylon

Front Air Deflector Grommet
Head Diameter: 28mm
Stem Length: 13mm
Use with Auveco 19613
C & K Trucks 1999-On
;Express & Savana Vans 2003 - On
UNIT PACKAGE: 25



24575
(3986976)

Rocker Panel Moulding Clip
GM Products 1971 - 1978

UNIT PACKAGE: 25



19361
(25554845)
Nylon

Rocker Panel Moulding Clip
Pontiac Bonneville 1992-On

UNIT PACKAGE: 20



23831
(20766166)
Nylon

Roof Moulding Clip
Cadillac Sedan DeVille 1989 - On

UNIT PACKAGE: 25



10220
(4457595, 4457495)
Nylon

Quarter Belt & Wheel Opening Moulding Clip
GM 1967 - On

UNIT PACKAGE: 50



11288
(9838109)
Gray Nylon

Body Side Moulding Clip
Buick, Chevrolet & Oldsmobile 1967-On

UNIT PACKAGE: 100



11425
(1688094)
Nylon

Vinyl Top Clip
Used on narrow Moulding across top of roof
Chevrolet, Cadillac & Oldsmobile 1974-On

UNIT PACKAGE: 50



11717
(1660123)
Nylon

Belt Moulding Clip
GM 1975-On

UNIT PACKAGE: 50



22228
(11547339)

Pale Green Nylon

Belt Moulding Clip
Width: 26mm
Length: 43mm
Chevrolet Silverado & Tahoe and GMC Sierra 2014 - On

UNIT PACKAGE: 15



9850
(7731589)

Natural Nylon

Quarter Panel Reveal Moulding & Landau Top Moulding Clip
Use with Auveco 9877

GM

UNIT PACKAGE: 100



10617
(8799350)

Nylon

Door, Quarter Panel & Rear End Moulding Clip
GM 1970-On

UNIT PACKAGE: 50



23649
(20037240)

Quarter Panel & Rear Wheel Opening Moulding Clip
GM 1977 - On

UNIT PACKAGE: 50



23646
(3062615)

Quarter Belt Reveal Moulding Clip
GM 1976 - On

UNIT PACKAGE: 100



12563

(20175051, 15633873)
Nylon

Quarter Belt Reveal Moulding Clip
GM 1980-On

UNIT PACKAGE: 50



12594
(20171942)

Nylon

Moulding Clip
GM 1980-On

UNIT PACKAGE: 25



12602
(20237057)
Nylon

Moulding Clip
GM 1980-On

UNIT PACKAGE: 25



23720
(20175890)

Belt Moulding Clip
GM 1981 - On

UNIT PACKAGE: 50



14642
(20199675)
Nylon

Quarter Belt Reveal Moulding Clip
Width: 7/16"
Length: 31/32"
GM 1980-On

UNIT PACKAGE: 50



12824
(20274997)
Nylon

Rear Quarter Reveal Moulding Clip
GM 1980-On

UNIT PACKAGE: 50



17219
(21093588)
Nylon

Roof Drip Moulding Clip
2 Door & 4 Door Models
GM Saturn 1991-On

UNIT PACKAGE: 25



10318
(8733059)
4492962, 9838109
Nylon

Body Side & Wheel Opening Moulding Clip
Buick, Chevrolet & Oldsmobile 1968-On

UNIT PACKAGE: 100



23676
(9828421)

Side Moulding Side
GM 1969 - On
Cadillac 1976 - 1977

UNIT PACKAGE: 50

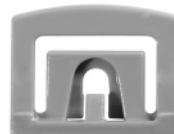

23723
(D9AZ-5403178-B)

Windshield Reveal Moulding Clip
Ford 1979 - On

UNIT PACKAGE: 50



20263
(22599312)
Black Nylon

Front & Rear Door Window Moulding Clip
Chevrolet Malibu, Oldsmobile
Achieva & Cutlass 1997 - On

UNIT PACKAGE: 25



20232
(10287926)
Yellow Nylon

Front & Rear Door Window Moulding Clip
Overall Length: 1-9/16"
Buick Century & Regal
and Oldsmobile Intrigue 1997 - On

UNIT PACKAGE: 25



20578
(GM: 88970495, 88973654;
Toyota: 76924-02020)
Black Nylon

Rocker Moulding Retainer
Head Diameter: 32mm
Stem Length: 10mm

Fits into 22mm Hole
Pontiac Vibe & Toyota Corolla 2003 - On

UNIT PACKAGE: 25



19411
(25630331)
Nylon

Front Door and Front & Rear Fender Moulding Clip
Pontiac Bonneville
1996-On

UNIT PACKAGE: 10



20280
(25648693)
Gray Nylon

Rocker Panel Moulding Clip
Width: 7/8"
Length: 2"
Cadillac DeVille &
Seville 1998 - On

UNIT PACKAGE: 10



20318
(25722671)
Gray Nylon

Rocker Panel Clip
Width: 7/8"
Length: 2"

Buick LeSabre, Cadillac DeVille & Seville, Oldsmobile Aurora and Pontiac Bonneville 2000 - On

UNIT PACKAGE: 10



22224
(92139070)
White Nylon

Pillar Trim Moulding Clip
Width from Ear to Ear: 9.3mm
Bottom Width: 10.4mm
Overall Height: 15.5mm
Chevrolet Caprice & SS 2011 - On
Pontiac G8 2009 - 2008

UNIT PACKAGE: 25



22161
(GM: 94748652, Ford: W714972-S300)
White Nylon

Quarter Panel & Exterior Trim Moulding Clip

Width from Ear to Ear: 8mm
Overall Height: 15mm
Buick: Enclave 2018 - On
Cadillac: CT4, CT5 2020 - On, ELR 2016 - 2014, Escalade 2021 - On; Chevrolet: Bolt EV 2017 - On, Corvette 2019 - 2017, Suburban 2021 - On, Traverse 2021 - 2018; GMC: Yukon 2021 - On
Ford: Bronco 2021, C-Max 2018 - 2013, EcoSport, Expedition 2021 - 2018, Edge, F-150, Mustang, Explorer 2021 - 2015, Escape 2013 - On, F-250, F350 SD 2020 - 2017, Fiesta 2019 - 2011, Fusion, Police 2020 - 2013, Ranger 2021 - 2019, SSV Plug-In Hybrid 2020 - 2019, Taurus 2019 - 2010, Transit Connect 2019 - On, Transit-150, 250, 350 2020 - 2015, Lincoln: Aviator 2020 - On, Continental 2020 - 2017, Corsair 2021 - 2020, MKC 2019 - 2015, MKS 2016 - 2013, MKT 2019 - 2013, MKX 2018 - 2011, MKZ 2020 - 2013, Nautilus 2020 - 2019, Navigator 2020 - 2015

UNIT PACKAGE: 25



22021
(Ford: W790225-S900)
Gray Nylon

Fender Corner & Rocker & Windshield Moulding Clip

Top Head Size: 16mm x 23mm
Bottom Head Diameter: 17mm
Stem Length: 12mm
Fits into 9mm Hole
Ford Focus 2018 - 2012; Bronco 2021 - On; Lincoln Continental 2019 - 2017

UNIT PACKAGE: 10



20408
(10287547)
White Nylon

Door & Rocker Panel Moulding Clip

Top Head Size: 3.5mm x 8mm
Bottom Head Size: 8.7mm x 12mm
Stem Length: 8mm
Fits into 8mm Hole
Buick Century, Regal & Pontiac Grand Prix 1995 - On

UNIT PACKAGE: 25



23965
Nylon

Side Moulding Clip

Fits in 1/2" x 7/32" Hole
Used on various mouldings
GM 1962 - 1966

UNIT PACKAGE: 25



22846
(GM: 11547341)
Black Nylon

Bumper Moulding Clip

Head Size: 11.5mm x 21mm
Stem Length: 11mm
Overall Height: 17mm
Buick Enclave & Envision,
Cadillac ATS, CT6, CTS, ELR; Escalade, XT4 & XT5,
Chevrolet Blazer, Bolt EV, Camaro,
Corvette, Cruze, Equinox, Impala, Malibu, Silverado,
Sonic, Suburban, Tahoe, Traverse, Trax & Volt, GMC;
Acadia, Sierra 2500/3500, Terrain & Yukon 2018 - On

UNIT PACKAGE: 50



25271
(GM: 11548932, 11547077)
Red Nylon

Door Trim Panel Clip

Top Head Size: 9mm x 12mm
Bottom Head Diameter: 17mm
Stem Size: 6.5mm x 10mm
Stem Length: 13mm
Overall Height: 17.5mm
Buick Envision 2020 - 2016; Cadillac ELR 2016 - 2014, XT5 2020 - 2017, XT6 2021 - 2021; Chevrolet Camaro, Malibu 2016 - On Equinox 2020 - 2018; Colorado, Cruze, Volt 2019 - 2016, Impala 2019 - 2014; GMC Acadia 2020 - 2017, Canyon 2019 - 2015, Terrain 2020 - 2018

UNIT PACKAGE: 25



15695
(Toyota: 62955-20020; GM: 94848834)
Nylon

Retainer with Sealer

Head Diameter: 15mm
Stem Length: 9mm
Fits into 8mm Hole
Toyota Pick-Up Truck, Pontiac Vibe

UNIT PACKAGE: 25



23961
(96057293, 83943-86000)
Nylon

Cowl Vent Retainer
Head Size: 12mm x 15mm
Fits in 7mm Hole
Geo Tracker 1999 - On
Suzuki Vitara 1999 - On

UNIT PACKAGE: 25



21316
(94530742)
White Nylon

Fender, Wheel, Side & Bumper Moulding Clip with Sealer
Top Head Size: 11mm x 15mm
Bottom Head Diameter: 16mm
Stem Length: 10mm
Fits into 8mm Hole
Saturn Vue 2008 - On
Chevrolet Captiva & Cruze 2011 - On

UNIT PACKAGE: 15



21158
(11569920)
Green Nylon

Fender Moulding Clip with Sealer
Top Head Size: 7.5mm x 11mm
Bottom Head Size: 15mm x 15mm
Stem Length: 13mm
Fits into 7mm Hole
Buick Enclave, Cadillac CTS, Chevrolet Traverse & GMC Acadia 2003 - On

UNIT PACKAGE: 10



25180
(GM: 11610700)
White Nylon

Interior Door Handle Trim, Exterior Moulding Retainer with Sealer
Top Head Size: 8mm x 12mm
Bottom Head Diameter: 15mm
Stem Size: 5.5mm x 8.5mm
Stem Length: 9.3mm
Overall Height: 13mm
Buick Encore 2020 - On; Cadillac ATS 2019 - 2015;
ELR 2016 - 2014; XT4 2019 - On; XT5 2020 - 2017;
XTS 2019 - 2013; Chevrolet Bolt, Silverado & GMC Sierra 2017 - On; Cruze, Volt 2019 - 2016;
Trailblazer 2021 - On

UNIT PACKAGE: 15



21825
(11611375)
White Nylon

Moulding Clip with Sealer
Top Head Size: 8mm x 18mm
Bottom Head Diameter: 15mm
Stem Length: 13mm
Fits into 8mm Hole
Cadillac, Chevrolet & GMC 2014 - 13

UNIT PACKAGE: 15



22222
(92138865)
White Nylon

Body Side Moulding Clip
Top Head Size: 23mm x 28mm
Bottom Head Diameter: 19mm
Stem Length: 14mm
Fits into 9mm Hole
Chevrolet Caprice & SS 2011 - On
Pontiac G8 2009 - 2008

UNIT PACKAGE: 15



20326
(25718851)
Yellow Nylon

Door Trim Moulding Clip
Head Size: 9/16" x 3/4"
Stem Length: 3/8"
Cadillac DeVille & Seville 1998 - On

UNIT PACKAGE: 25



22022
(24405740)
Blue Nylon

Windshield Pillar, Interior & Trunk Trim Moulding Clip with Metal Reinforcement
Top Head Size: 17mm x 20mm
Bottom Head Size: 14mm x 28mm
Stem Length: 11mm
Buick Allure, Lacrosse, Regal & Verano, Cadillac XTX, Chevrolet Camaro, Caprice, Cruze, Malibu, Sonic & Volt, Pontiac G8 and Saturn Astra 2008 - On

UNIT PACKAGE: 15



25421
(GM: 13435002)
Green Nylon

Lower Center Pillar Interior Moulding Trim Clip with Metal Reinforcement
Top Head Size: 17mm x 20mm
Bottom Head Size: 14.5mm x 28mm
Stem Length: 12mm
Buick Regal 2020 - 2018

UNIT PACKAGE: 25



22167
(11547026)
Red Nylon

Interior Trim & Windshield Garnish Moulding Clip with Metal Reinforcement
Top Head Size: 17mm x 24mm
Bottom Head Size: 14mm x 28mm
Stem Length: 10mm
Cadillac ATS & CTS, Chevrolet Impala and GMC Yukon 2013 - On

UNIT PACKAGE: 10



22276
(11547024)
Red Nylon

Door Sill Plate Moulding Clip with Metal Reinforcement & Sealer
Top Head Size: 17mm x 24mm
Bottom Head Size: 10mm x 24mm
Stem Length: 10mm
Cadillac ELR & XTS 2013 - On
Chevrolet Camaro & Malibu 2016 - On

UNIT PACKAGE: 10

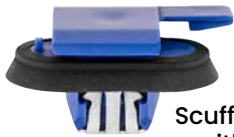

22268
(11611367)
Blue Nylon

Scuff Plate & Trim Panel Moulding Clip with Sealer & Metal Reinforcement
Top Head Size: 17mm x 24mm
Bottom Head Size: 10mm x 24mm
Stem Length: 10mm
Overall Height: 16mm
Buick Verano, Cadillac ATS, CTS & XTS, Chevrolet Camaro, Impala, Malibu & Volt 2011 - On

UNIT PACKAGE: 10



24161
(11611367)
Black Nylon

Interior Trim Garnish Moulding Clip with Metal Reinforcement
Overall Length: 17mm
Hole Size: 8 x 20mm
Stem Length: 12mm
Bottom Head Diameter: 14 x 28mm
Top Head Diameter: 17 x 24mm

UNIT PACKAGE: 10



19757
(10431524)
Black Nylon

Rocker Panel Moulding Clip
Head Size: 11/16" x 1-5/16"
Stem Length: 9/16"
Fits into 5/16" Hole
Chevrolet Impala, Lumina & Monte Carlo 2000 - On

UNIT PACKAGE: 15



19800
(10352803, 10437565)
Black Nylon

Rocker Panel Moulding Clip
Head Size: 15/32" x 1-5/16"
Stem Length: 9/16"
Fits into 5/16" Hole
Chevrolet Impala, Lumina & Monte Carlo 2000 - On

UNIT PACKAGE: 10



20775
(10352809)
White Nylon

Rocker Panel Moulding Clip
Head Size: 11/16" x 1-5/16"
Stem Length: 11/16"
Fits into 5/16" Hole
Chevrolet Impala, Lumina & Monte Carlo 2000 - On

UNIT PACKAGE: 15



20808
(10352799)
Black Nylon

Rocker Panel Moulding Clip
Head Size: 11/16" x 1-5/16"
Stem Length: 11/16"
Fits into 5/16" Hole
Chevrolet Impala, Lumina & Monte Carlo 2000 - On

UNIT PACKAGE: 15



20973
(10352798)
Tan Nylon

Rocker Panel Moulding Clip
Head Size: 11/16" x 1-5/16"
Stem Length: 11/16"
Fits into 5/16" Hole
Chevrolet Impala, Lumina & Monte Carlo 2000 - On

UNIT PACKAGE: 15



20976
(25742293)
Blue Nylon

Rocker Panel Moulding Clip
Top Head Size: 9/16" x 25/32"
Bottom Head Size: 5/8" x 25/32"
Stem Length: 9/16"
Fits into 3/8" Hole
Cadillac DeVille & Seville 2000 - On

UNIT PACKAGE: 15



20972
(11589176)
White Nylon

Rocker Panel Moulding Clip
Top Head Size: 3/4" x 1-1/32"
Bottom Head Size: 19/32" x 1-1/32"
Stem Length: 9/16"
Fits into 3/8" Hole
Chevrolet Malibu 2004 - On

UNIT PACKAGE: 15



20952
(15236894)
White Nylon

Rocker Panel Moulding Clip
Top Head Size: 9/16" x 23/32"
Overall Height: 5/8"
Stem Length: 7/16"
Fits into 3/8" Hole
Buick Lucerne and
Cadillac CTS & STS 2003 - On

UNIT PACKAGE: 15



20865
(15221959)
Gray Nylon

Rocker Panel Moulding Clip
Width: 9/16"
Length: 1-1/8"
Stem Length: 9/16"
Fits into 1/2" Hole
Chevrolet Cobalt & HHR 2005 - On

UNIT PACKAGE: 15



20377
(11518357)
White Nylon

Rocker Panel Moulding Clip with Sealer
Top Head Size: 9/16" x 13/16"
Bottom Head Size: 13/16" x 13/16"
Stem Length: 9/16"
Fits into 7/16" Hole
Chevrolet Avalanche 2002 - On

UNIT PACKAGE: 15



19820
(22603384)
White Nylon

Rocker Panel Moulding Clip
Head Size: 3/4" x 1-3/16"
Stem Length: 19/32"
Fits into 7/16" Hole
Oldsmobile Alero
& Pontiac Grand Am 1999 - On

UNIT PACKAGE: 15



20417
(91176726)
White Nylon

Side Door, Wheel Opening & Rocker Panel Moulding Clip with Sealer
Top Head Size: 15/32" x 25/32"
Bottom Head Size: 9/16" x 25/32"
Stem Length: 7/16"
Fits into 7/16" Hole
Geo Tracker 2001 - On

UNIT PACKAGE: 15



21128
(11562563)
White Nylon

Rocker Moulding Clip
Upper Head Size: 12mm x 20mm
Bottom Head Size: 12mm x 32mm
Stem Length: 15mm
Fits into 10mm Hole
Chevrolet Malibu 2008 - On

UNIT PACKAGE: 15



20328
(10443956)
White Nylon

Rocker Panel Moulding Clip
Top Head Size: 9/16" x 13/16"
Bottom Head Size: 13/16" x 13/16"
Stem Length: 9/16"
Fits into 7/16" Hole
Chevrolet Impala, Lumina, Monte Carlo
and C & K Trucks 2000 - On

UNIT PACKAGE: 15



20607
(10323057)
White Nylon

Rocker Moulding Clip
Top Head Size: 12mm x 20mm
Bottom Head Size: 12mm x 24mm
Stem Length: 14mm
Fits into 9mm Hole
Pontiac Grand Prix 2004 - On

UNIT PACKAGE: 15



19822
(25693852)
Gray Nylon

Rocker Panel Moulding Clip
Top Head Size: 9/16" x 3/4"
Bottom Head Size: 5/8" x 3/4"
Stem Length: 9/16"
Fits into 7/16" Hole
Buick LeSabre; Cadillac Concours, DeVille,
Eldorado & Seville; Chevrolet Impala,
Lumina & Monte Carlo; Oldsmobile Aurora
and Pontiac Bonneville 1995 - On

UNIT PACKAGE: 25



20885
(15288146, 15893516)
Gray Nylon

Windshield Pillar Moulding Clip with Sealer
Top Head Size: 12mm x 20mm
Bottom Head Size: 14mm x 20mm
Stem Length: 15mm
Fits into 9mm Hole
Chevrolet Equinox & Pontiac Torrent 2005 - On

UNIT PACKAGE: 15



22258
(11547211)
White Nylon

Rocker Moulding Clip with Sealer
Top Head Size: 12mm x 20mm
Bottom Head Size: 12mm x 20mm
Stem Length: 16mm
Fits into 9mm Hole
Cadillac CT6 2016 - On

UNIT PACKAGE: 10



21793
(11610495)
White Nylon

Rocker Panel Moulding Clip with Sealer
Top Head Size: 12mm x 20mm
Bottom Head Size: 12mm x 24mm
Stem Length: 14mm
Fits into 9mm Hole
Chevrolet Camaro 2010 and Pontiac G6 & Grand Prix 2004 - On

UNIT PACKAGE: 15



22036
(11546635, 11612122)
Yellow Nylon

Rocker Moulding Clip with Sealer
Top Head Size: 9mm x 20mm
Bottom Head Size: 14mm x 20mm
Stem Length: 14mm
Fits into 9mm Hole
Cadillac ATS & CTS 2013 - On

UNIT PACKAGE: 10



20774
(25724529)
White Nylon

Rocker Moulding & Grille Moulding Clip
Top Head Size: 9/16" x 13/16"
Bottom Head Size: 5/8" x 13/16"
Stem Length: 9/16"
Fits into 3/8" Hole
Buick LeSabre & Rainier; Cadillac Concours, CTS, DeVille, Eldorado, Escalade, Seville, SRX & STS; Chevrolet Avalanche, Impala, Lumina, Monte Carlo, SSR, Vans & Trucks; Oldsmobile Aurora & Bravada and Pontiac Bonneville 1992 - On

UNIT PACKAGE: 15

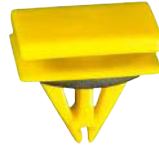

20756
(5480852)
Yellow Nylon

Rocker Panel Moulding Clip with Sealer
Top Head Size: 9/16" x 25/32"
Bottom Head Size: 5/8" x 13/16"
Stem Length: 9/16"
Chevrolet Equinox 2005 - On

UNIT PACKAGE: 10



20934
(15127746)
White Nylon

Body Side Moulding Clip
Top Head Size: 12mm x 20mm
Bottom Head Size: 12mm x 20mm
Stem Length: 11mm
Fits into 9mm Hole
Buick Terraza, Chevrolet Uplander, GMC Acadia, Pontiac Montana SV6 and Saturn Relay 2005 - On

UNIT PACKAGE: 15



21242
(11562250)
White Nylon

Rocker Panel Moulding Clip with Sealer
Top Head Size: 12mm x 20mm
Bottom Head Size: 12mm x 20mm
Stem Length: 11mm
Fits into 9mm Hole
GMC Acadia 2007 - On

UNIT PACKAGE: 15



21374
(GM: 11571175;
Chrysler: 68172491AA)
Gray Nylon

Rocker Moulding Clip with Sealer
Top Head Size: 12mm x 20mm
Bottom Head Size: 12mm x 20mm
Stem Length: 11mm
Fits into 9mm Hole
Chevrolet Traverse 2010 - On
Chrysler 200 2015 - On
Jeep Grand Cherokee 2015 - 2012

UNIT PACKAGE: 15



22492
(GM: 11547581)
White Nylon

Body Side & Exterior Trim Moulding Clip with Sealer
Top Head Size: 12mm x 20mm
Bottom Head Diameter: 19mm
(Including Sealer)
Stem Length: 11mm
Fits into 9mm Hole
Cadillac XT5, Chevrolet Cruze & Impala 2014 - On

UNIT PACKAGE: 25



21129
(11569918)
White Nylon

Roof Rail Moulding Clip with Sealer
Top Head Size: 13mm x 30mm
Stem Length: 13mm
Fits into 7mm Hole
Buick Enclave &
GMC Acadia 2007 - On

UNIT PACKAGE: 15



20481
(10423553)
Green Nylon

Side Moulding, Fender & Rocker Panel Moulding Clip
Top Head Size: 1/2" x 13/16"
Bottom Head Size: 19/32" x 13/16"
Stem Length: 9/16"
Fits into 7/16" Hole
Pontiac Aztek and
GM C & K Trucks 2001 - On

UNIT PACKAGE: 15



20521
(10242285, 10308019, 10297369)
Black Nylon with Sealer

Rocker Panel Moulding Clip
Top Head Size: 15/32" x 25/32"
Bottom Head Size: 5/8" x 25/32"
Stem Length: 9/16"
Fits into 7/16" Hole
Pontiac Aztek, Montana
& Trans Sport 1997 - On

UNIT PACKAGE: 15



20353
(10442914)
White Nylon

Rocker Panel Moulding Clip
Top Head Size: 1/2" x 9/16"
Bottom Head Size: 9/16" x 5/8"
Stem Length: 9/16"
Fits into 7/16" Hole
Buick Rendezvous 2002 - On

UNIT PACKAGE: 15



21504
(10445899)
Black Nylon

Door Moulding Clip
Top Head Size: 14mm x 20mm
Bottom Head Size: 15.5mm x 20mm
Stem Length: 14mm
Fits into 9mm Hole
GM SUV's 1997 - On

UNIT PACKAGE: 15



22027
(11570847)
Yellow Nylon

Lower Door Moulding Clip with Sealer
Top Head Size: 12.5mm x 20mm
Bottom Head Diameter: 18mm
Stem Length: 11mm
Fits into 9mm Hole
Cadillac SRX 2010 - On

UNIT PACKAGE: 10



19379
(10297371)
Yellow Nylon

Rear Wheel Opening Moulding Clip
Top Head Size: 19/32" x 25/32"
Stem Length: 9/16"
Fits into 7/16" Hole
Pontiac Trans Sport, Montana
with Long Wheel Base 1997 - On

UNIT PACKAGE: 15



20825
(10297370)
Brown Nylon

Moulding Clip with Sealer
Top Head Size: 12mm x 20mm
Bottom Head Size: 15mm x 20mm
Stem Length: 14mm
Fits into 11mm Hole
Chevrolet Venture, Oldsmobile Silhouette, Pontiac
Trans Sport APV & Montana and Hummer 1997 - On

UNIT PACKAGE: 15



22029
(11547210)
Green Nylon

Moulding Clip with Sealer
Top Head Size: 12mm x 20mm
Bottom Head Size: 12mm x 20mm
Stem Length: 10mm
Fits into 9mm Hole
Cadillac XTS & Chevrolet Impala 2014 - 2013

UNIT PACKAGE: 10



20935
(15116576, 15282120)
Green Nylon

Body Side Moulding Clip
Head Size: 16mm x 38mm
Stem Length: 15mm
Fits into 10mm Hole
Buick Terraza, Cadillac C & K Truck, Chevrolet C, K
Truck & Uplander, GMC Acadia, C & K Truck, Pontiac
Montana SV6 and Saturn Relay 2005 - On

UNIT PACKAGE: 15



21036
(11518988)
White Nylon

Fender, Spoiler & Roof Rack Moulding Clip with Sealer

Top Head: 12mm x 21mm
Bottom Head: 12mm x 20mm
Stem Length: 15mm
Fits into 9mm Hole

Buick Enclave, Chevrolet SSR,
GMC Acadia, Hummer H3, S & T Trucks 2002 - On

UNIT PACKAGE: 15



21667
(11609923)
Gray Nylon

Moulding Clip with Sealer

Top Head Size: 12mm x 20mm
Bottom Head Size: 12mm x 24mm
Stem Length: 16mm

Chevrolet Camaro and Pontiac G6 2005 - On

UNIT PACKAGE: 15



21013
(Not Available from O.E.M.)
Yellow Nylon

Rocker Panel Moulding Clip

Top Head Size: 15/32" x 13/16"
Bottom Head Size: 15/32" x 25/32"
Stem Length: 9/16"
Fits into 3/8" Hole

Hummer H3 2005 - On

UNIT PACKAGE: 15



22373
(Not Available From O.E.M.)
Black Nylon

Rocker Panel Moulding Clip

Top Head Size: 12mm x 20mm
Bottom Head Size: 12mm x 24mm
Stem Length: 15mm
Fits into 9mm Hole

GMC 2016 - On
Saturn Aura 2007 - On

UNIT PACKAGE: 15



21370
(25922739, 11570846)
Green Nylon

Rocker Moulding Clip with Sealer

Top Head Size: 12mm x 29mm
Bottom Head Size: 12mm x 20mm
Stem Length: 10mm
Fits into 9mm Hole

Buick Enclave, Cadillac SRX, Chevrolet Tahoe, Traverse
& GMC Acadia, Yukon 2009 - On

UNIT PACKAGE: 25

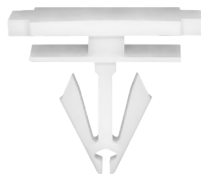

22534
(GM: 11588818)
White Nylon

Wheel Opening Moulding Clip

Top Head Size: 16mm x 26mm
Bottom Head Size: 14mm x 20mm
Stem Length: 16mm
Fits into 9mm Hole

Buick Encore, Cadillac XT5,
Chevrolet Bolt & Trax and
GMC Acadia & Hummer H3 2007 - On

UNIT PACKAGE: 25



22575
(GM: 11549137)
White Nylon

Rocker Panel Moulding Clip

Top Head Size: 33mm x 45mm
Bottom Head Size: 25mm x 37mm
Stem Length: 15mm

Fits into 9mm x 20mm Slot
Chevrolet Equinox &
GMC Terrain 2018 - On

UNIT PACKAGE: 10



25181
(GM: 11601845)
White Nylon

Rocker Moulding Clip with Sealer

Top Head Size: 33mm x 45.5mm
Middle Head Size: 29mm x 45.5mm
Bottom Head Size: 21mm x 42mm
Stem Size: 8mm x 13mm
Stem Length: 12mm
Overall Height: 25.7mm
Fits into 9mm Slot

Buick Enclave 2018 - On; Cadillac CT4,
CT5 2020 - On;
Chevrolet Traverse 2021 - On

UNIT PACKAGE: 10



21200
(11588818, 11561329)
Black Nylon

Front Bumper and Rocker Moulding Clip

Top Head Size: 18mm x 26mm
Bottom Head Size: 14mm x 20mm
Stem Length: 15mm
Fits into 10mm Hole

Cadillac STS and Corvette 2005 - On

UNIT PACKAGE: 10



22542
(GM: 11547523)
Black Nylon

Headliner Retainer
Top Head Size: 12mm x 22mm
Bottom Head Size: 12mm x 22mm
Stem Diameter: 9mm
Stem Length: 9mm
Buick Envision & LaCrosse, Cadillac CT6 and GMC Acadia 2016 - On

UNIT PACKAGE: 15



22226
(92138807)
White Nylon

Rocker Moulding Clip
Width: 31.5mm
Length: 45mm
Bottom Head Diameter: 25mm
Stem Length: 15mm
Fits into 9mm Hole
Chevrolet Caprice & SS 2011 - On
Pontiac G8 2009 - 2008

UNIT PACKAGE: 25



22225
(92138808)
Black Nylon

Rocker Moulding Clip
Top Head Size: 15mm x 21mm
Middle Head Size: 15mm x 21mm
Bottom Head Size: 19.3mm x 25.5mm
Stem Length: 14mm
Fits into 9mm Hole
Chevrolet Caprice & SS 2011 - On
Pontiac G8 2009 - 2008

UNIT PACKAGE: 25



21177
(10363352)
Black Nylon

Rocker, Pillar and Floor Moulding Clip
Top Head Size: 18mm x 38mm
Bottom Head Size: 22mm x 40mm
Stem Length: 33mm
Fits into 11mm Hole
Saturn Aura 2007 - On

UNIT PACKAGE: 15



20951
(15236893)
Black Nylon

Rocker Panel Moulding Clip
Top Head Size: 3/4" x 1-9/16"
Overall Height: 11/16"
Stem Length: 7/16"
Fits into 3/8" Hole
Buick Lucerne 2006 - On

UNIT PACKAGE: 15



19821
(10431761)
Gray Nylon

Rocker Panel Moulding Clip
Top Head Size: 11/16" x 1-1/2"
Bottom Head Size: 7/8 x 1-9/16"
Stem Length: 1-1/4"
Fits into 7/16" Hole
Chevrolet Impala, Lumina & Monte Carlo 2000 - On

UNIT PACKAGE: 15



20884
(11561491, 15872008)
Black Nylon

Rocker Panel Moulding Clip with Sealer
Top Head: 20mm x 30mm
Overall Length: 28mm
Fits into 17mm Hole
Chevrolet Equinox & Pontiac Torrent 2005 - On

UNIT PACKAGE: 10

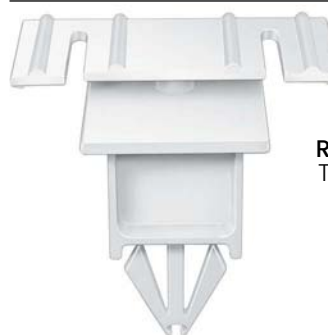

20950
(10384814)
White Nylon

Rocker Panel Moulding Clip
Top Head Size: 3/4" x 1-9/16"
Overall Height: 1-7/16"
Stem Length: 21/32"
Fits into 7/16" Hole
Buick Lucerne 2006 - On

UNIT PACKAGE: 15



21503
(25744385)
Green Nylon

Rocker Moulding Clip
Head Size: 22mm x 46mm
Stem Length: 17mm
Fits into 10mm Hole
Cadillac 1998 - On

UNIT PACKAGE: 15



21827
(11611435)
White Nylon

Moulding Clip with Sealer
Top Head Size: 22mm x 45mm
Bottom Head Size: 25mm x 37mm
Stem Length: 15mm
Fits into 10mm Hole
Cadillac, Chevrolet & GMC 2014 - 13
UNIT PACKAGE: 10



21161

(11569697)
Green Nylon

Side Window (Rear) Reveal Moulding Clip with Sealer

Flange Size: 10mm x 17mm
Stem Length: 20mm
Overall Length: 29mm
Fits into 8mm Hole
Buick Lucerne 2006 - On

UNIT PACKAGE: 5



21157

(11610522, 10383817)
White Nylon

Side Window (Rear) Reveal Moulding Clip with Sealer

Top Head Size: 6mm x 11mm
Bottom Head Size: 10mm x 17mm
Stem Length: 20mm
Fits into 8mm
Buick Lucerne 2006 - On

UNIT PACKAGE: 10



22037

(15864780; 11569921)
Yellow Nylon

Rocker Moulding Clip with Sealer

Top Head Size: 9.5mm x 20mm
Bottom Head Size: 14mm x 20mm
Stem Length: 20mm
Fits into 9mm Hole
Cadillac ATS & CTS 2013 - On

UNIT PACKAGE: 10



22803

(GM: 11569921)
Yellow Nylon

Rocker, Wheel Opening & Spoiler Moulding Clip

Top Head Size: 9.5mm x 20mm
Bottom Head Size: 14mm x 20mm
Stem Length: 20mm
Fits into 9mm Hole
Buick Enclave & Envision, Cadillac XTS, Chevrolet Bolt EV, Equinox, Traverse and GMC Acadia & Terrain 2017 - On

UNIT PACKAGE: 10



21335

(25775903)
Green Nylon

Rocker Moulding Clip with Sealer

Top Head Size: 12mm x 16mm
Bottom Head Size: 12mm x 20mm
Stem Length: 24mm
Fits into 9mm Hole
Buick Enclave, Chevrolet Traverse, GMC Acadia & Saturn Outlook 2007 - On

UNIT PACKAGE: 10



21375

(25774893)
Yellow Nylon

Door Moulding Clip

Top Head Size: 12mm x 16mm
Bottom Head Size: 12mm x 20mm
Stem Length: 24mm
Fits into 9mm Hole
Chevrolet Traverse 2010 - On

UNIT PACKAGE: 15



20891

(11589244, 11569973)
Yellow Nylon

Rocker Panel Moulding Clip with Sealer

Top Head Size: 15/32" x 27/32"
Bottom Head Size: 15/32" x 25/32"
Stem Length: 1-3/8"
Fits into 7/16" Hole
Chevrolet Equinox, Pontiac Torrent and Trucks 2005 - On

UNIT PACKAGE: 10



21739

(11611626)
White Nylon

Tailgate Cover Clip

Top Head Size: 12.5mm x 23mm
Bottom Head Size: 12.5mm x 23mm
Stem Length: 11mm
Fits into 9mm Hole
Cadillac Escalade; Chevrolet Avalanche, Silverado, Suburban & Tahoe and GMC Sierra 2007 - On

UNIT PACKAGE: 25



11119

(9617200)
Nylon

Roof, Inner Side Front, Rear & Panel Headlining Clip

GM 1973-On

UNIT PACKAGE: 100



18398

(20058837)
Nylon

Windshield Upper Garnish Moulding Clip

GM A & G Models 1988-78

UNIT PACKAGE: 10



16865
(20462090)
Nylon

Garnish Moulding Clip
Buick Century & Regal, Chevrolet
Camaro, Celebrity, Monte Carlo &
Malibu, Oldsmobile Cutlass & Ciera,
Pontiac Firebird Grand Prix &
6000 1978-On

UNIT PACKAGE: 25



9965
(3944866, 1244839)

Universal Moulding Fastener
Across Flats: 1-1/4"
Hole Size: 5/16"
GM

UNIT PACKAGE: 25

12971

Same as 9965 except for unit package quantity

UNIT PACKAGE: 10



2943
(4759145, 4761842, 4779348)

**Front and Rear Fender and
Door Peak Moulding Fastener**
Across Flats: 1-1/4"
Hole Size: 3/8"
Left Arm: 9/16"
GM

UNIT PACKAGE: 50

12966

Same as 2943 except for unit package quantity

UNIT PACKAGE: 15



23702

Moulding Clip with Sealer
General Purpose
GM & Other Makes

UNIT PACKAGE: 25



19602

Chevrolet Grille Bolt Kit
For installing and attaching Grille on Chevrolet Cars
Consists of: 50 pcs. 10-24 x 1/2" Machine Screws
50 pcs. 10-24 Keps Nuts

UNIT PACKAGE: 50 Sets



14953
(GM: 15679091; Ford: N803494S)
Black Nylon

Fascia, Trim & Grille Retainer
Head Size: 15/32" x 15/32"
Stem Length: 21/32"
Fits into 1/4" Square Hole or Slot
GM 1994 - On
Ford 1985 - On

UNIT PACKAGE: 25



14727

(GM: 94221150;
Isuzu: 8942211500;
Nissan: 63844-D0100)
Black Nylon

Push-Type Retainer
Head Size: 14mm x 22mm
Stem Length: 9mm
Fits into 7mm Hole
Geo Storm 1990 - On

UNIT PACKAGE: 25



20892
(12337831)
Black Nylon

**Front Bumper
Push-Type Retainer**
Head Size: 14mm x 26mm
Stem Length: 14mm
Fits into 8mm Hole
Pontiac G6 2005 - On

UNIT PACKAGE: 50



14008
(14032200)
Black Nylon

Grille Attachment Retainer
Head Size: 3/4" x 19/32"
Stem Length: 19/32"
Fits into 5/16" Hole
GM 1981-On

UNIT PACKAGE: 25



22041
(92139147)
Black Nylon

**Front & Rear Bumper Fascia
Push-Type Retainer**
Head Size: 14mm x 21mm
Stem Length: 16mm
Fits into 8mm Hole
Chevrolet Caprice and
Pontiac G8 & GTO 2011 - 04

UNIT PACKAGE: 25



14001
(14039420)
Black Nylon

Push-Type Retainer
Head Diameter: 21/32"
Stem Length: 19/32"
Fits into 5/16" Hole
GM (Including Saturn)

UNIT PACKAGE: 25



14697
(GM: 94198687;
Honda: 90657-SA6-0030;
Mazda: N304-13-356-A)
Black Nylon

Push-Type Retainer
Head Diameter: 14mm
Stem Length: 11mm
Fits into 7mm Hole

UNIT PACKAGE: 25



19726
(94858343)
Black Nylon

Door Trim Panel Push-Type Retainer
Head Diameter: 14mm
Stem Length: 8mm (Excluding the Pin)
Fits into 6mm Hole
Geo Prizm 1998 - On

UNIT PACKAGE: 15



19645
(94858864)
Nylon

Door Trim Panel Push-Type Retainer
Head Diameter: 14mm
Stem Length: 8mm (Excluding the Pin)
Fits into 6mm Hole
Geo Prizm 1998 - On

UNIT PACKAGE: 15



14260
(Toyota: 90467-06017;
Mazda: 9926-50-625;
GM: 20426301)
Black Nylon

Push-Type Retainer
Head Diameter: 15mm
Stem Length: 12mm
Fits into 7mm Hole

UNIT PACKAGE: 15



19243
(GM: 30008324; Suzuki: 09409-07325)
Black Nylon

Push-Type Retainer
Head Diameter: 16mm
Stem Length: 10mm (Excluding the Pin)
Fits into 9mm Hole
Front & Rear Bumper Fascia
Geo Metro 1989-On
Radiator Grille
Suzuki Esteem 1995-On

UNIT PACKAGE: 15



13457
(20451119)
Black Nylon

Front Compartment Spare Tire Retainer
Head Diameter: 43/64"
Stem Length: 23/32"
Fits into 5/16" Hole
GM

UNIT PACKAGE: 10



20577
(GM: 88970494, 88973676;
Toyota: 90467-07168)
Black Nylon

Rocker Panel & Garnish Moulding Push-Type Retainer
Head Diameter: 20mm
Stem Length: 8mm
Fits into 7mm Hole
Pontiac Vibe 2003 - On
Lexus & Toyota 2000 - On

UNIT PACKAGE: 15



19140
(Acura: 90505-SL0-003;
GM: 94852368;
Mitsubishi: MB888869;
Toyota: 90467-08155)
Black Nylon

Push-Type Retainer
Head Diameter: 20mm
Stem Length: 21mm
Fits into 8mm Hole
Acura, Dodge Avenger, Eagle Talon, Geo Prizm Mitsubishi Eclipse & Galant and Toyota 1993-On

UNIT PACKAGE: 5



17214
(GM: 10089262, 21042098;
Chry: 55075139)
Black Nylon

Push-Type Retainer
Head Diameter: 11mm (7/16")
Stem Length: 18mm (11/16")
Fits into 6mm (15/64") Hole
GM & Saturn 4 Door & Station Wagon 1987-On

UNIT PACKAGE: 25

14987

Same as 17214 except for unit package quantity

UNIT PACKAGE: 50



14990

(22538102)
Black Nylon

Push-Type Retainer

Head Diameter: 7/16"
Stem Length: 15/32"
Fits into 15/64" Hole
GM 1987 - On

UNIT PACKAGE: 50



19788

(10246149; 22657634)
Black Nylon

Rocker Panel Push-Type Retainer

Head Diameter: 11mm
Stem Length: 20mm
Fits into 6mm Hole

Achieva, Cutlass, Grand Am & Malibu 1999 - On

UNIT PACKAGE: 25



19787

(22657634)
Black Nylon

Fender & Rocker Panel Push-Type Retainer

Head Diameter: 12mm
Stem Length: 17mm
Fits into 6mm Hole

Achieva, Cutlass, Grand Am & Malibu 1999 - On

UNIT PACKAGE: 25



14995

(GM: 10195515, Ford: N805026S;
Chry: 4696488, 6503163)
Black Nylon

Push-Type Retainer

Head Diameter: 1/2"
Stem Length: 1-13/64"
Fits into 9/32" Hole
GM, Ford & Chrysler 1987 - On

UNIT PACKAGE: 25



16859

(Nissan: 66860-01W01;
GM: 94051993)
Black Nylon

Cowl Panel to Reinforcement Plate & Engine Splash Shield Retainer

Head Diameter: 14mm (9/16")
Stem Length: 16mm (5/8")
Fits into 6mm (1/4") Hole
Nissan 1980-On
Geo Storm 1990-On

UNIT PACKAGE: 25



20943

(15014352)
Black Nylon

Cowl Vent Push-Type Retainer
Head Diameter: 14mm
Stem Length: 23mm
Fits into 7mm Hole
Buick Lucerne 2006 - On

UNIT PACKAGE: 15



21112

(94530438)
Black Nylon

Fender Liner Push-Type Retainer
Head Diameter: 15mm
Stem Length: 14mm
Fits into 6mm Hole
Chevrolet Aveo 2004 - On

UNIT PACKAGE: 25



23822

(B040-68-865-A96, 94530438)
Nylon

Interior Trim, Cowl, Fender & Bumper Push-Type Retainer

Head Diameter: 15mm
Stem Length: 14mm
Fits in 6mm Hole
Ford Probe 1988
Mazda M6 1988 - On
Chevrolet Aveo 2004 - On

UNIT PACKAGE: 25



14997

(10053182)
Black Nylon

Push-Type Retainer
Head Diameter: 19/32"
Stem Length: 13/16"
Fits into 5/16" Hole
GM 1987 - On

UNIT PACKAGE: 25



23826

(22538004)

Grille to Headlamp Housing Push-Type Retainer
Head Diameter: 17mm
Stem Length: 22mm
Fits in 6.3mm Hole
GM, Pontiac, Olds "J" Body 1989 - On

UNIT PACKAGE: 50



14991
(GM: 10139822; 25680782;
Ford: N808147S)
Black Nylon

Push-Type Retainer
Head Diameter: 11/16"
Stem Length: 11/16"
Fits into 1/4" Hole
GM & Ford 1987 - On

UNIT PACKAGE: 25



20265
(25663903)
Black Nylon

**Radiator Support Sight Shield
Push-Type Retainer**
Head Diameter: 1"
Stem Length: 1"
Fits into 1/4" Hole
Cadillac DeVille & Seville 1998 - On

UNIT PACKAGE: 10



14753
(GM: 15773445, 20452072, 20664092;
Ford: N804570S; Chry: 4638136)
Black Nylon

Radiator Shroud & Trim Retainer
Head Diameter: 11/16"
Stem Length: 7/8"
Fits into 1/4" Hole
GM 1982-On
Ford 1986-On
Chrysler 1998 - On

UNIT PACKAGE: 25



17227
(21077405)
Black Nylon

**Door Handle to Door Hardware
Attachment Push-Type Retainer**
Head Diameter: 7mm
Stem Length: 10mm
Fits into 5mm Hole
2 Door & 4 Door Models GM Saturn 1991-On

UNIT PACKAGE: 25



14993
(22538004)
Black Nylon

Push-Type Retainer
Head Diameter: 11/16"
Stem Length: 7/8"
Fits into 1/4" Hole
GM 1987 - On

UNIT PACKAGE: 25



17383
(GM: 94847334, 96057847;
Toyota: 90467-07066;
Suzuki: 09409-07313)
Black Nylon

**Radiator Grille & Trim Panel
Push-Type Retainer**
Head Diameter: 11mm
Stem Length: 14mm (Excluding the Pin)
Fits into 7mm Hole
Geo Tracker & Prizm 1992 - 89

UNIT PACKAGE: 10



16835
(GM: 10140480; Chry: 6502625)
Black Nylon

Rear Bumper Fascia Retainer
Head Diameter: 21mm (27/32")
Shoulder Length: 3mm (1/8")
Stem Length: 25mm (1")
Fits into 12mm (1/2") Hole
APV Vans 1990-On

UNIT PACKAGE: 25



21246
(22690838)
Black Nylon

Door Trim Push-Type Retainer
Head Diameter: 12mm
Stem Length: 14mm (Excluding the Pin)
Fits into 6mm Hole
Chevrolet Malibu & Pontiac G6 2004 - On

UNIT PACKAGE: 25



14998
(15672330, 15956470)
Black Nylon

Push-Type Retainer
Head Diameter: 27/32"
Stem Length: 1"
Fits into 13/32" Hole
GM 1987 - On

UNIT PACKAGE: 25



17162
(GM: 96057846; Hyundai: 86155-22000;
Toyota: 90467-07041)
Black Nylon

Push-Type Retainer
Head Diameter: 15mm
Stem Length: 8mm (Excluding the Pin)
Fits into 6.3mm Hole
Geo Metro & Tracker 1989 - On

UNIT PACKAGE: 10



19297

(11517824, 21035345)
Black Nylon

Liftgate Upper Window & Lower Garnish Moulding Push-Type Retainer

Head Diameter: 16mm
Stem Length: 12mm (Excluding the Pin)
Fits into 7mm Hole
GM Saturn 1998 - 93

UNIT PACKAGE: 15



11699

(GM: 472434; Chry: 6031390)
Black Nylon

Cowl Ledge Weatherstrip & Fender Liner Push-Type Retainer

Head Diameter: 11/16"
Stem Length: 5/8"
Fits into 1/4" Hole
GM 1970-On
Chrysler 1968-On

UNIT PACKAGE: 50



19892

(25695687)
Black Nylon

Radiator Support Sight Shield Push-Type Retainer

Head Diameter: 27mm
Shoulder Length: 7mm
Stem Length: 18mm
Fits into 10mm Hole
Cadillac DeVille & Seville 2000 - On

UNIT PACKAGE: 15



22552

(GM: 9130754)
Black Nylon

Front Bumper

Push-Type Retainer
Head Diameter: 16mm
Stem Length: 10mm
Fits into 6mm Hole
Cadillac Catera 2001 - 2000
Saturn Astra 2008

UNIT PACKAGE: 25



14011

(14019226, 14071289)
Black Nylon

Radiator Overflow Bottle/Windshield Washer Bottle Retainer

Head Diameter: 21/32"
Stem Length: 9/16"
Fits into 5/16" Hole
GM 1981 - On

UNIT PACKAGE: 25



12567

(GM: 14019205, 14019206, 16514113;
Chry: 34201621, 6504090)
Black Nylon

Front Fender Mud Skirt & Fender Liner Push-Type Retainer

Head Diameter: 11/16"
Stem Length: 9/16"
Fits into 1/4" Hole
GM 1981 - On

UNIT PACKAGE: 25

14007

Same as 12567 except for unit package quantity

UNIT PACKAGE: 50



23954

(16514113)
Nylon

Front Lamp Mounting & Pivots Push-Type Retainer

Head Diameter: 17.8mm
Stem Length: 14.2mm
Fits in 6.35mm Hole
GM Cars & Trucks 1988 - On

UNIT PACKAGE: 25



21238

(22718369)
Black Nylon

Fuel Tank Shield & Miscellaneous Push-Type Retainer

Head Diameter: 26mm
Stem Length: 12mm
Fits into 10mm Hole
Chevrolet Malibu & Trail Blazer 2004 - On

UNIT PACKAGE: 25



19847

(5973823)
Blue Nylon

Fascia Retainer

Head Diameter: 7/8"
Shoulder Length: 5/32"
Stem Length: 25/32"
Fits into 1/2" Hole
GM 1979-On

UNIT PACKAGE: 25



14010

(GM: 14045480; Chry: 6508746-AA)
Black Nylon

Fascia Retainer

Head Diameter: 1"
Stem Length: 23/32"
Fits into 3/8" Hole
GM 1982 - On and Chrysler 2009 - On

UNIT PACKAGE: 25



12757
(5973400)
Black Nylon

Fascia Retainer
Head Diameter: 1"
Shoulder Length: 1/8"
Stem Length: 3/4"
Fits into 1/2" Hole
GM 1979 - On

UNIT PACKAGE: 15

16265

Same as 12757 except for unit package quantity

UNIT PACKAGE: 50



12756
(5973996)
Brown Nylon

Fascia Retainer
Head Diameter: 1"
Shoulder Length: 1/4"
Stem Length: 7/8"
Fits into 1/2" Hole
GM 1982 - On

UNIT PACKAGE: 15



14016
(GM: 16500308; Chry: 6500787)
Black Nylon

Tail Light Retainer
Top Head Diameter: 3/8"
Stem Length: 7/16"
Fits into 3/16" Hole
GM & Chrysler

UNIT PACKAGE: 25



13999
(20363491)
Black Nylon

Body Side Moulding Push-Type Retainer
Top Head Diameter: 3/8"
Stem Length: 1/2"
Fits into 7/32" Hole
GM 1979 - On

UNIT PACKAGE: 25



19522
(22644361)
Black Nylon

Door Sill Trim Plate Push-Type Retainer
Head Diameter: 12mm
Stem Length: 18mm
Fits into 6mm Square Hole

Chev. Malibu, Olds Achieva & Cutlass 1997 - On

UNIT PACKAGE: 15



19355
(15960621)
Black Nylon

Rear Door Radio Speaker Push-Type Retainer
Head Diameter: 17/32"
Stem Length: 1-5/64"
Fits into 1/4" Hole
GM Trucks C & K 1, 2 1995 - On

UNIT PACKAGE: 25



16816
(GM: 21047094, Chrysler: 6502632)
Black Nylon

Push-Type Retainer
Top Head Diameter: 14mm
Stem Length: 14mm
Fits into 6mm Hole
GM Saturn SC, SC1, SC2, SL1, SL2, SW1, SW2 1994 - 1991; Chrysler Pacifica 2017 - On; Voyager 2020; Dodge Charger 2016 - 2015; Durango 2003 - 2001; Jeep Grand Cherokee 2014; Ram 1500, 2500, 3500 2010 - On

UNIT PACKAGE: 25



17222
(GM: 21075686; Ford: F3LY-14570-B)
Black Nylon

Push-Type Retainer
Head Diameter: 15mm
Stem Length: 20mm
Fits into 8mm Hole
Rocker Panel, Wheel Liner & Air Inlet Duct Applications
GM Saturn 2 Door & 4 Door Models 1991-On
Ford

UNIT PACKAGE: 25



22347
(11561878)
Black Nylon

Bumper, Fender Liner, Cowl, Grille, Air Inlet Duct, Rocker Panel, Wheel Liner, Quarter Panel & Upper Deflector Push-Type Retainer with Sealer
Head Diameter: 15mm
Stem Length: 21mm
Fits into 8mm Hole
Various Buick, Cadillac Chevrolet, GMC, Hummer, Saab & Saturn Models 1991 - On

UNIT PACKAGE: 25



17103

(GM: 15681408;
Ford: N803709S)
Black Nylon

Fascia Retainer

Head Diameter: 15mm
Stem Length: 23mm
Fits into 6mm Hole
GM & Ford 1986 - On

UNIT PACKAGE: 50



17226

(10207146, 21077323)
Black Nylon

**Rear Door Rocker Panel to Underbody
Bracket Push-Type Retainer**

Head Diameter: 15mm
Stem Length: 29mm
Fits into 8mm Hole
GM Saturn 4 Door Models 1991 - On

UNIT PACKAGE: 25



19801

(GM: 21077123; Chry: 6509103AA
Ford: W705436-S300)
Black Nylon

**Wheel Opening Moulding
Push-Type Retainer**

Head Diameter: 19/32" (15mm)
Stem Length: 3/4" (19mm)
Fits into 1/4" (6mm) Hole
Saturn 1991 - On; Ford 2002 - On
Chrysler 2010 - On

UNIT PACKAGE: 25



20542

(15994165)
Black Nylon

**Bumper & Rear Wheel Apron
Push-Type Retainer**

Head Diameter: 16.5mm
Stem Length: 27mm
Fits into 8mm Hole
Saturn L Series 2000 - On

UNIT PACKAGE: 25



22219

(92138636)
Black Nylon

Air Baffle Push-Type Retainer

Head Diameter: 18mm
Stem Length: 23mm
Fits into 7.5mm Hole
Chevrolet Caprice 2013 - 2012
Pontiac G8 and GTO 2009 - 2004

UNIT PACKAGE: 25



19639

(GM: 15149708; Chry: 6506008AA; Ford:
W709176-S300)
Black Nylon

**Radiator, Wheelhouse, Fender & Front
Bumper Cover, Grille, Rocker**

Push-Type Retainer

Head Diameter: 17mm
Stem Length: 16mm
Fits into 6mm Hole
GM C & K Trucks 1999 - On;
Jeep Liberty 2002 - On;
Ford Explorer 2010 - 2007, F150 2009 - On,
Mustang 2014 - 2005, Transit 2015 - On

UNIT PACKAGE: 25



16624

(1636632, 20687704)
Black Nylon

Front Bumper Fascia Retainer

Head Diameter: 17mm
Shoulder Length: 2mm
Stem Length: 18mm
Fits into 9.5mm (3/8") Hole
Buick Riviera/Reatta 1988 - On

UNIT PACKAGE: 25



18030

(Chry: 6501925; GM: 10134407,
Ford: W717870-S300)
Black Nylon

Push-Type Retainer

Head Size: 11/16"
Stem Length: 13/16"
Fits into 1/4" Hole
Chrysler Concorde & LHS
Dodge Intrepid & Eagle Vision 1993-On
Coolant Recovery Reservoir; GM 1992-On; Ford
Edge 2015 - On, Ranger 2019 - On, Bronco 2021 - On,
Lincoln Nautilus 2019 - On, MKX 2018 - 2016

UNIT PACKAGE: 25

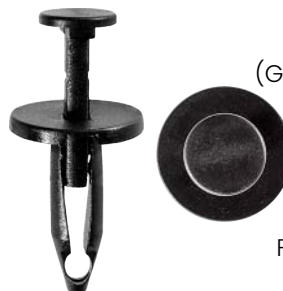

13993

(GM: 20510029; Ford: N803362-S;
Chry: 34202672)
Black Nylon

Body Retainer

Head Diameter: 11/16"
Stem Length: 7/8"
Fits into 1/4" Hole
Ford, GM & Chrysler 1984 - On

UNIT PACKAGE: 25



13996

(20452072, 20590899)
Black Nylon

Exterior Body Retainer

Head Diameter: 11/16"
Stem Length: 7/8"
Fits into 9/32" Hole
GM 1984-On

UNIT PACKAGE: 25



20869

(GM: 88970767;
Toyota: 90467-10183)
Black Nylon

Front Fender Liner

Push-Type Retainer
Head Diameter: 18mm
Stem Length: 7.5mm Hole
Fits into 7mm Hole

Pontiac Vibe, Lexus and Toyota 1999 - On

UNIT PACKAGE: 10



20365

(10301966, 10425306)
Black Nylon

Cowl Vent Push-Type Retainer

Head Diameter: 18mm
Stem Length: 13mm
Fits into 7.5mm Square Hole
Pontiac Aztek 2001 - On

UNIT PACKAGE: 10



20988

(GM: 11589289;
Chrysler: 6508863-AA;
Ford: W713610-S300)
Black Nylon

**Air Distributor & Windshield Defroster
Push-Type Retainer**

Head Diameter: 18mm
Stem Length: 17.5mm

Panel Range: 2.0mm - 4.5mm

Fits into 6.5mm Hole

Buick Enclave, Chevrolet Equinox, Chevrolet & GMC S & T Trucks, GMC Acadia and

Pontiac Torrent 2002 - On; Ford EcoSport 2018 - On;

Edge 2015 - On; Fusion 2013 - On; Ranger 2019 - On;

Transit 2014 - On; Escape 2019 - 2013;

Expedition 2019 - 2018; Mustang 2019 - 2015;

C-Max 2018 - 2013; Focus 2018 - 2008; Bronco 2021 - On

Lincoln Nautilus 2019 - On; MKC 2019 - 2015;

MKZ 2019 - 2013; Navigator 2019 - 2018;

Continental 2018 - 2017

UNIT PACKAGE: 25



20888

(GM: 11561368; Chry: 6508712AA)
Black Nylon

**Fender, Wheel & Bumper
Push-Type Retainer**

Head Diameter: 18mm
Stem Length: 20mm

Panel Range: 3.0mm - 5.8mm

Fits into 9.5mm Hole

Chevrolet Impala & Monte Carlo and
Pontiac Grand Prix & Solstice 2004 - On

Jeep Wrangler 2000 - On

UNIT PACKAGE: 25



20880

(GM: 11589290
Chry: 6509049-AA;
Ford: W714040-S300)
Black Nylon

**Air Inlet Grille, Bumper Fascia &
Front Brake Caliper Cooling Duct
Push-Type Retainer**

Head Diameter: 18mm
Stem Length: 20mm

Panel Range: 4.5mm - 7.0mm

Fits into 6.5mm Hole

Buick Enclave, Cadillac CTS & STS,
Chevrolet Cobalt, Equinox & SSR, GM Trucks
and Pontiac G5 & Torrent 2002 - On

Chrysler Charger & 300 2011 - On

UNIT PACKAGE: 50



21672

(11611110)

Black Nylon

**Cowl Vent Push-Type
Retainer with Sealer**

Head Diameter: 18mm
Stem Length: 20mm

Fits into 6.3mm Hole

Buick Allure & LaCrosse
and Chevrolet Volt 2010 - On

UNIT PACKAGE: 15



20989

(GM: 11589291;

Ford: W713331-S300)

Black Nylon

Air Dam & Grille Push-Type Retainer

Head Diameter: 18mm

Stem Length: 22mm

Panel Range: 7.0mm - 9.5mm

Fits into 6.5mm Hole

Cadillac CTS, SRX and STS 2003 - On

UNIT PACKAGE: 25



21529

(95230842)

Black Nylon

**Cowl Vent Push-Type
Retainer with Sealer**

Head Diameter: 18mm
Stem Length: 22mm

Fits into 6.5mm Hole

Chevrolet Cruze 2011 - On

UNIT PACKAGE: 15



16622

(10157900, 11517803, 15993201)

Black Nylon

Front Bumper Fascia Retainer

Head Diameter: 18mm
Stem Length: 23mm

Fits into 9.5mm (3/8") Hole

Olds Cutlass 1990-On

GM Lt. Truck 1996 - On

UNIT PACKAGE: 25



20359
(11519444)
Black Nylon

Bumper Cover Push-Type Retainer
Head Diameter: 18mm
Stem Length: 26mm
Fits into 10mm Hole
Oldsmobile Intrigue, Pontiac
Aztek & Grand Prix 1997 - On

UNIT PACKAGE: 25



20631
(11588988)
Black Nylon

Front Bumper Cover Push-Type Retainer
Head Diameter: 18mm
Stem Length: 26mm
Fits into 10mm Hole
Pontiac Grand Prix 2004 - On

UNIT PACKAGE: 25



20826
(11609417)
Black Nylon

Fender Apron Push-Type Retainer
Head Diameter: 19mm
Stem Length: 14mm
Panel Range: 2.7mm - 5.3mm
Fits into 8.5mm Hole
Buick Enclave & LaCrosse, Cadillac CTS, SRX & STS,
Chevrolet Cobalt, Equinox & Malibu, GM Trucks and
Pontiac G5, G6 & Torrent 2003 - On

UNIT PACKAGE: 50



20990
(GM: 15296830;
Chrysler: 5116530-AA)
Black Nylon

**Fascia & General Purpose
Push-Type Retainer**
Head Diameter: 19mm
Stem Length: 16mm
Panel Range: 5.0mm - 7.0mm
Fits into 8mm Hole
GM 2007 - On

UNIT PACKAGE: 25



18308
(3540858)
Black Nylon

**Radiator Air Baffle
Push-Type Retainer**
Large Head Diameter: 3/4"
Stem Length: 1-1/8"
Fits into 1/4" Hole
Cadillac Eldorado &
Seville 1993-On

UNIT PACKAGE: 25



19239
(GM: 11519949;
Honda: 91512-SX0-003;
Mitsubishi: MU000319;
Lexus & Toyota: 90467-08217)
Black Nylon

**Front Fender, Bumper Support, Interior
Trim & Washer Tank Push-Type Retainer**
Head Diameter: 20mm
Stem Length: 11mm
Fits into 8mm Hole

Acura 3.5RL, Honda Accord, Prelude &
Odyssey 1994 - On; Mitsubishi Lancer 2002 - On;
GM 1997 - On; Lexus GX470 2009 - 2003;
Toyota 4Runner 2009 - 2003, FJ Cruiser 2014 - 2007,
Tacoma 2016 - 2005

UNIT PACKAGE: 25



22100
(11612035)
Black Nylon

**Front Fender & Body Side Liner
Push-Type Retainer**
Head Diameter: 20mm
Stem Length: 12mm
Fits into 8.5mm Hole

Chevrolet Colorado & SS and GMC Canyon 2014 - On

UNIT PACKAGE: 25



17216
(GM: 21030249; Ford: N807389S,
W704433-SS35B; Chry: 6503598)
Black Nylon

**Air Baffle to Under Carriage, Bumpers,
Fender Apron, Interior Panels
Push-Type Retainer**
Head Diameter: 20mm
Stem Length: 20mm
Fits into 8mm Hole

Cadillac: ATS 2019 - 2015, CTS 2019 - 2008,
ELR 2016 - 2014, SRX 2009, STS2011
Chevrolet: Camaro 2010 - On, Cobalt 2010 - 2005,
Cruze 2019 - 2016, Equinox 2015 - 2010, HHR 2011 - 2006,
Malibu 2019 - 2008, Traverse 2017 - 2009
GMC: Acadia 2017 - 2007, Terrain 2015 - 2010
Hummer: H3 2010 - 2009; Pontiac: G6 2009 - 2008
Saturn: Ion 2007 - 2003, L100, LW200, LW300 2002 - 2001,
L200 2003 - 2001, L300 2005 - 2001, LS, LS1, LS2, LW1,
LW2 2000, Outlook 2010 - 2007, SC 1992 - 1991, SC1,
SC2 2002 - 1993, SL, SL1, SL2 2002 - 1991, SW1 1999 - 1993,
SW2 2001 - 1993, Vue 2007 - 2002
Ford: Crown Victoria 2006 - 2003, Escape 2016 - 2005,
Explorer 2010 - 1999, F-150 2006 - 2004,
F250-F550 2016 - 2011, Fiesta 2013 - 2011,
Focus 2011 - 2002, Freestar 2007 - 2004,
Fusion 2012 - 2006, Mustang 2014 - 2005 & 1998,
Taurus X 2009 - 2008, Transit Van 2015 - On,
Windstar 2003 - 1998; Lincoln: Aviator 2005 - 2003,
Blackwood 2003 - 2002, MKX 2010 - 2007,
MKZ 2012 - 2007, Navigator 2002 - 1999, Zephyr 2006
Mercury: Grand Marquis 2006 - 2003,
Mariner 2011 - 2005, Monterey 2007 - 2004,
Mountaineer 2010 - 2002; Chrysler: 200 2014 - 2011,
Pacifica 2017, PT Cruiser 2006 - 2003,
Sebring 2010 - 2007; Dodge: Avenger 2014 - 2008,
Durango 2022 - 2011, Journey 2020 - 2009,
Neon 2005 - 2003, Nitro 2011 - 2008, Viper 2017 - 2013
Jeep: Cherokee 2014 - On, Commander 2010 - 2006,
Compass 2017 - On, Gladiator 2020 - On,
Grand Cherokee 2005 - On, Liberty 2012 - 2006,
Wrangler 2018 - On; RAM: 1500 2019 - On

UNIT PACKAGE: 25



16625
(10108746)
Black Nylon

Front Bumper Fascia Retainer
Head Diameter: 20mm
Stem Length: 20mm
Fits into 10mm Hole
GM Station Wagons 1991 - On
UNIT PACKAGE: 25



20991
(11589292)
Black Nylon

Bumper Fascia, Flares & Air Dam Push-Type Retainer
Head Diameter: 20mm
Stem Length: 20mm
Panel Range: 2.0mm - 4.5mm
Fits into 8.5mm Hole
Chevrolet & GMC, C & K Trucks 2007 - On
UNIT PACKAGE: 25



19615
(15153415)
Black Nylon

Rear Bumper Cover Push-Type Retainer
Top Head Diameter: 20mm
Stem Length: 21mm
Fits into 9mm Hole
C & K Trucks 1999 - On
UNIT PACKAGE: 25



20889
(GM: 11589293;
Ford: W712196-S300)
Black Nylon

Cowl Vent & Fender Push-Type Retainer
Head Diameter: 20mm
Stem Length: 22mm
Panel Range: 4.5mm - 7.0mm
Fits into 8.5mm Hole
Buick Century, LaCrosse & Regal, Cadillac, Chevrolet Equinox, GM Trucks, Hummer H3 and Pontiac Grand Prix & Torrent 1997 - On; Ford Edge 2007 - On; Explorer 2020 - On; Fusion 2006 - On; F-150 2019 - 2016; F-250, F-350 2018 - 2017; Fiesta 2019 - 2011; Flex 2019 - 2009; Bronco 2021 - On; Lincoln Aviator 2020 - On; Nautilus 2019 - On; Continental 2019 - 2017; MKC 2019 - 2015; MKT 2019 - 2010; MKX 2019 - 2007; Milan 2011 - 2006
UNIT PACKAGE: 25



20992
(11589294)
Black Nylon

Bumper Fascia, Fender and Toe/Floor Panel Push-Type Retainer
Head Diameter: 20mm
Stem Length: 24mm
Panel Range: 7.0mm - 10.0mm
Fits into 8.5mm Hole
Buick Enclave & LaCrosse, Chevrolet & GMC C & K Trucks, GMC Acadia, Hummer H3 and Saturn Outlook 2005 - On
UNIT PACKAGE: 25



20632
(GM: 11518017)
Ford: W708530-S300
Black Nylon

Bumper Cover & Fender Shield Push-Type Retainer
Head Diameter: 20mm
Stem Length: 26mm
Fits into 8mm Hole
GM & Ford 1997 - On
UNIT PACKAGE: 15



18896
(21095797)
Black Nylon

Bumper Fascia Push-Type Retainer
Large Head Diameter: 20mm
Stem Length: 28mm
Fits into 8mm Hole
GM Saturn 1996 - On
UNIT PACKAGE: 25



20863
(5480772)
Black Nylon

Lower Rocker Moulding Push-Type Retainer
Head Diameter: 22mm
Stem Length: 13mm
Fits into 15mm Hole
Chevrolet Equinox 2005 - On
UNIT PACKAGE: 10



15043
(14103461)
Black Nylon

Bumper Fascia Retainer
Head Diameter: 7/8"
Shoulder Length: 5/32"
Stem Length: 1-3/64"
Fits into 1/2" Hole
GM 1987 - On
UNIT PACKAGE: 25



20993
(GM: 11589295;
Ford: W712665-S300)
Black Nylon

Fender, Flare, Gas Tank & Panel Attachment Push-Type Retainer
Head Diameter: 25mm
Stem Length: 20mm
Panel Range: 3.0mm-6.0mm
Fits into 10.5mm Hole
Chevrolet Cobalt & HHR, GM C & K Trucks and Pontiac G5 2005 - On
UNIT PACKAGE: 25



20994
(11589296)
Black Nylon

Panel Attachment & General Purpose Push-Type Retainer
Head Diameter: 25mm
Stem Length: 23mm
Panel Range: 6.0mm - 9.0mm
Fits into 10.5mm Hole
Buick Enclave and GMC Acadia 2007 - On

UNIT PACKAGE: 25



14020
(GM: 14093088; Ford: N802781-S)
Black Nylon

Splash Shield & Fascia Retainer
Head Diameter: 1
Stem Length: 7/8"
Fits into 1/4" Hole
GM 1979 - On

UNIT PACKAGE: 25

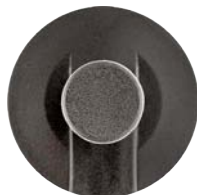

14147
(20547865)
Black Nylon

Body Retainer
Head Diameter: 1"
Stem Length: 7/8"
Fits into 1/4" Hole
GM 1984 - On

UNIT PACKAGE: 25



13994
(GM: 20570245, 20635065
Ford: N804614S)
Black Nylon

Splash Shield, Seat Cushion & Spare Tire Retainer
Head Diameter: 1"
Stem Length: 7/8"
Fits into 5/16" Hole
GM 1984 - On

UNIT PACKAGE: 25



18310
(22587036)
Black Nylon

Rear Bumper Fascia Push-Type Retainer
Head Diameter: 1"
Stem Length: 15/16"
Fits into 3/8" Hole
Chevrolet Cavalier & Pontiac Sunfire 1995 - On

UNIT PACKAGE: 25



15702
(14101262)
Black Nylon

Plastic Cover on Engine Compartment Retainer
Head Diameter: 1"
Shoulder Length: 1/8"
Stem Length: 15/16"
Fits into 1/2" Hole
Buick, Olds & Pontiac 1988 - On

UNIT PACKAGE: 25



15044
(22535007)
Black Nylon

Bumper Fascia Retainer
Head Diameter: 1"
Shoulder Length: 1/8"
Stem Length: 1"
Fits into 1/2" Hole
GM 1987 - On

UNIT PACKAGE: 25



15045
(10053388, 22542705)
Black Nylon

Bumper Fascia Retainer
Head Diameter: 1"
Shoulder Length: 1/8"
Stem Length: 1-7/64"
Fits into 1/2" Hole
GM 1987-On

UNIT PACKAGE: 25



15042
(10077283)
Black Nylon

Bumper Fascia Retainer
Head Diameter: 1"
Shoulder Length: 1/4"
Stem Length: 1-1/8"
Fits into 1/2" Hole
GM 1982-On

UNIT PACKAGE: 25



17616
(21077131)
Black Nylon

Bumper Fascia Push-Type Retainer
Head Diameter: 1-3/16"
Stem Length: 2"
Fits into 7/16" Hole
GM Saturn 1991-On

UNIT PACKAGE: 10



21361
(GM: 11561874;
Nissan: 622A2-9E000A)
Black Nylon

Bumper Cover Push-Type Retainer
Head Diameter: 25mm
Stem Length: 29mm
Fits into 7mm Hole
Chevrolet Malibu, Pontiac G6
and Saturn Aura 2007 - On
Nissan Altima 1997 - On

UNIT PACKAGE: 15



21176
(10382313)
Black Nylon

Sight Shield & Trim Push-Type Retainer
Head Diameter: 24.5mm
Stem Length: 13mm
Fits into 9mm Hole
Cadillac STS, Pontiac Solstice
and Saturn Sky 2005 - On

UNIT PACKAGE: 10



18268
(15959832)
Black Nylon

Front License Plate Bracket Push-Type Retainer
Head Diameter: 1"
Shoulder Length: 9/64"
Stem Length: 1-5/8"
Fits into 1/2" Hole
GM Truck 1994-On

UNIT PACKAGE: 5



18353
(15960325)
White Nylon

Door Trim Panel Push-Type Retainer
Head Diameter: 9/16"
Stem length: 41/64"
Fits into 1/4" Hole
GM Trucks C, K, 1, 2, 3 1995-On

UNIT PACKAGE: 50



20244
(25707329)
Green Nylon

Push-Type Retainer with Sealer
Head Diameter: 19mm
Stem Length: 32mm
Fits into 8mm Hole
Buick LeSabre, Oldsmobile Aurora
& Pontiac Bonneville 2000 - On

UNIT PACKAGE: 10



18334
(15959833)
Gray Nylon

Front License Plate Bracket Push-Type Retainer
Head Diameter: 1"
Stem Length: 1-3/4"
Fits into 1/2" Hole
GM S-10 Truck
with Decor Package
1994-On

UNIT PACKAGE: 5



19417
(Chry: 6503819, 6503401;
GM: 25631448)
Black Nylon

M7.5 x 35mm
Square Drive Truss Head
Head Diameter: 22mm
Shoulder Diameter: 9mm
Foam to Bumper Fascia
Chrysler 1993 - On
GM 1997 - On

UNIT PACKAGE: 15



25052
(GM: 15924986)
Black Nylon

Body Mount Cushion Sleeve
Top Diameter: 28mm
Bottom Diameter: 17.5mm
Overall Height: 23mm
Cadillac Escalade 2018 - 2006;
Chevrolet Avalanche 2013 - 2006;
Silverado, Suburban, Tahoe, GMC
Sierra, Yukon 2006 - On

UNIT PACKAGE: 25



21517
(25705182)
Black Nylon

M9.5 x 46mm
Bumper Fascia Nylon Screw
Head Diameter: 22mm
Square Drive
Cadillac Escalade & XLR,
Chevrolet Avalanche & Tahoe and
GMC Suburban, Yukon &
Yukon Denali 2004 - On

UNIT PACKAGE: 25



20970
(Not Available from O.E.M.)
Black Nylon

M14 x 34mm
**Bumper and Door Insulator
Nylon Screw**
Head Outer Diameter: 22mm
No. 3 Square Drive
Fits into 12mm Hole
GM, Ford & Chrysler 2005 - On

UNIT PACKAGE: 25



13860
(20478294)
Black Nylon

Carpet Retainer
Head Diameter: 30mm
Fits onto 6mm Stud
GM 1984-On

UNIT PACKAGE: 25



21164
(11610049)
Black Nylon

Bumper Cover Turn & Lock Retainer
Overall Length: 24.5mm
Buick Enclave, Cadillac Escalade,
Chevrolet Suburban & Traverse and
GMC Acadia & Yukon 2007 - On

UNIT PACKAGE: 25



19472
(GM: 25535963; Ford: N811772S)
Nylon

**Instrument Panel Insulation and
Front Compartment Rear Sight
Shield Turn Retainer**
Buick Electra, LeSabre, Park Ave. & Skylark,
Cadillac DeVille, Oldsmobile Achieva,
Cutlass, Delta 88, 88 Royale & 98 Regency
And Pontiac Bonneville
& Grand Am 1991 - On
Upper Deflector Shield
Ford

UNIT PACKAGE: 25



21377
(11609483)
Black Nylon

Rear Hatch Sill Plate Retainer
Top Head Diameter: 12mm
Bottom Head Size: 17mm x 34mm
Stem Length: 15mm
Chevrolet HHR 2006 - On

UNIT PACKAGE: 10



22953
(GM: 11547637)
Natural Nylon

Bumper Deflector Flange Nut
Thread Size: M4.2 (#8)
Flange O.D.: 20mm
Hex Size: 10mm
Height: 13.5mm
Buick Regal & Verano 2017 - 2014
Cadillac CT6, Chevrolet Cruze,
Equinox & GMC Terrain 2016 - On
Cadillac ATS, CTS, XTS &
Chevrolet Malibu 2018 - 2014;
Chevrolet Cruze 2019 - 2014

UNIT PACKAGE: 25



25221
(GM: 11612034)
Black Nylon

Wheelhouse Liner Nut
Thread Size: M4.2 (#8)
Flange O.D.: 20mm
Hex Size: 10mm
Height: 15.5mm
Buick LaCrosse & Cadillac ELR 2016 - 2014,
Verano 2017; Cadillac XTS 2019 - 2013; Chevrolet
Cruze, Volt 2019 - 2016, Sonic 2012 - On,
Impala 2020 - 2014, Malibu 2013 - On
Chevrolet Silverado & GMC Sierra 2019 - On

UNIT PACKAGE: 25



25054
(GM: 94530387)
Black Nylon

Wheel House Liner Retainer

Head Diameter: 30mm
Stem Diameter: 10mm
Stem Length: 8mm
Overall Height: 10mm
Fits 5mm Stud

Buick Allure 2015 - 2010;
Cascada 2018 - 2016; Enclave 2018;
Envision 2016 - On; LaCrosse 2010 - On;
Regal 2011 - On; Verano 2017 - 2012; Cadillac ATS,
CTS 2013 - 2019; ELR 2016 - 2014; XT4 2019 - On;
XT5 2017 - On; T6 2019 - On; XTS 2018 - 2013;
Chevrolet Aveo 2011 - 2004; Blazer 2020 - On;
Bolt 2018 - On; Camaro 2010 - On;
Colorado 2018 - 2015; Cruze 2018 - 2011;
Equinox 2018; Impala 2018 - 2014; Malibu 2013 - On;
Silverado 2020 - On; Sonic 2018 - 2012;
Spark 2018 - 2013; SS 2017 - 2014;
Traverse 2018 - On; Trax 2018 - 2015; Volt 2018 - 2011;
GMC Acadia 2017 - On; Canyon 2018 - 2015;
Terrain 2018; Pontiac G3 2010 - 2009; G8 2009 - 2008

UNIT PACKAGE: 25



21302
(11610748)
Black Nylon

Grille Retainer Nut

Hex: 13mm
Washer Diameter: 25mm
Overall Height: 7mm

Mates with Auveco 21301
Cadillac SRS & SRX and
Chevrolet Camaro 2010 - On

UNIT PACKAGE: 25



19440
(12040984)
Black Nylon

Wire Loom Routing Clip

Inner Diameter: 1/4"
Outer Diameter: 3/8"

UNIT PACKAGE: 15



19795
(12015631)
Black Nylon

Wire Loom Routing Clip

Inner Diameter: 1/4"
Outer Diameter: 3/8"

UNIT PACKAGE: 15



14544
(8911473)
Black Nylon

Wire Loom Routing Clip

Inner Diameter: 1/32"
Outer Diameter: 1/2"

UNIT PACKAGE: 25



20471
(8905794)
Black Nylon

Wire Loom Routing Clip

Inner Diameter: 10mm
Outer Diameter: 13mm

UNIT PACKAGE: 15



20397
(12160858)
Gray Nylon

Wire Loom Routing Clip

Inner Diameter: 10mm
Outer Diameter: 13mm

UNIT PACKAGE: 15



14545
(8911497)
Black Nylon

Wire Loom Routing Clip

Inner Diameter: 13/32"
Outer Diameter: 19/32"

UNIT PACKAGE: 25



14546
(8911472)
Black Nylon

Wire Loom Routing Clip

Inner Diameter: 1/2"
Outer Diameter: 11/16"

UNIT PACKAGE: 25



19851
(12040983)
Black Nylon

Wire Loom Routing Clip
Inner Diameter: 1/2"
Outer Diameter: 11/16"

UNIT PACKAGE: 15



23089
(12176839)
Nylon

Wire Loom Routing Clip
Conduit: 16mm (.625)
Hole Size: 6.35mm (1/4")
GM & General Purpose

UNIT PACKAGE 25



14547
(3816659, 8917320)
Black Nylon

Wire Loom Routing Clip
Inner Diameter: 3/4"
Outer Diameter: 1"

UNIT PACKAGE: 25



20665
(12160374)
Black Nylon

Wire Loom Routing Clip
Inner Diameter: 19mm
Outer Diameter: 24mm

UNIT PACKAGE: 15



20514
(12160857)
Gray Nylon

Wiring Harness Clip
Head Size: 9mm x 37mm
Fits into 6.3mm (1/4") Hole
GM

UNIT PACKAGE: 50



19853
(12176844)
Gray Nylon

Wiring Harness Clip
Size: 3/8" x 2-1/2"
Stem Length: 1/2"
Fits into 1/4" Hole
GM

UNIT PACKAGE: 25



22529
(GM: 22581725)
Black Nylon

Hood Release Cable Clip
Top Head Diameter: 19mm
Will hold 4.76mm to
6.35mm diameter cable
Bottom Head Diameter: 17mm
Stem Diameter: 8mm
Stem Length: 16mm
Chevrolet Equinox, Silverado, Traverse,
GMC Terrain

and Pontiac Solstice 2006 - On

UNIT PACKAGE: 25



22530
(GM: 10150076)
Black Nylon

Hood Latch & Cable Clip
Inside Diameter of Hole: 15.7mm
Width Across Bottom: 26mm
Stem Length: 11mm
Fits into 6.3mm (1/4") Hole
Chevrolet Camaro, Canyon, Equinox,
Malibu, Silverado, GMC Colorado & Sierra
and Oldsmobile Cutlass 1997 - On

UNIT PACKAGE: 25



14217
(GM: 1257702, 20346654;
Ford: 383207-S; AMC: 3693099)
Nylon

Routing Clip
GM, Ford & AMC

UNIT PACKAGE: 25



21203
(Not Available from O.E.M.)
Gray Nylon

Photo not actual size
Cable Tie

Overall Length: 155mm (6-1/8")
Width: 5mm (3/16")
Maximum Bundle Diameter: 30mm (1-3/16")
Fits into 6.3mm (1/4") Hole
GM and Universal

UNIT PACKAGE: 25



12729
(25512081)
Nylon

Engine Compartment Wire Clip
For 1/4" Diameter Tube
Buick with V-6 Diesel 1985-On

UNIT PACKAGE: 25



21284
(5482087)
White Nylon

Grille Clip
Overall Height: 14mm (9/16")
Chevrolet Equinox 2005 - On

UNIT PACKAGE: 25



23818
(90467-12020, H200-50-715
BF67-50715, 75103-SJ4-003)
Gray Nylon

Grille & Headlamp Door Clip
Toyota Corolla 1983 - On
Chevrolet Nova 1986 - On
Mazda 323 1986 - On
Ford Festiva, Tracer 1988 - On
Explorer 1996 - On
Honda Accord 1990 - 1993

UNIT PACKAGE: 25



24147
(4770719)
Nylon

Door Weatherstrip Clip
GM 1959

UNIT PACKAGE: 100



18402
Phosphate & Green
Weatherstrip Clip
GM

UNIT PACKAGE: 25



22065
(Not Available from O.E.M.)
Black Phosphate

Door & Quarter Glass Channel Clip
Width: 9mm
Length: 16mm
Overall Height: 13mm
GM

UNIT PACKAGE: 50



23563
(4887979)

Glass Run Channel Clip
GM Trucks 1963 - 1964

UNIT PACKAGE: 100



23617
(325338)

Door Weatherstrip Clip
GM 1971 - 1972

UNIT PACKAGE: 50



11831
(554343, 562327; 1241972)

Bumper Fastener
GM 1973-On

UNIT PACKAGE: 50



21187
(Chrysler: 4806226-AA, 68004187-AA;
GM: 11562364; Ford: W710754-S439)
Zinc

**Front & Rear Bumper
and Grille Fastener**

Screw Size: #6
Width: 10mm
Overall Height: 18mm
Buick Lucerne and Cadillac CTS & STS 2005 - On
Chrysler 300, Dodge Nitro,
Jeep Commander 2005 - On;
Ford Fiesta, Fusion, Gr. Marquis 2010 - On,
Escape 2013 - On, Flex 2019 - 2009, Transit 2015 - On,
Bronco 2021 - On

UNIT PACKAGE: 15

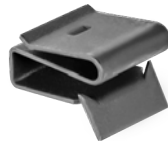

11352
(3920179,
10013764)

Radiator Shroud Clip
Chevrolet 1968-On

UNIT PACKAGE: 100



21387
(15683327)
Phosphate

**Front Door Interior Trim &
Instrument Panel Fastener**

Width: 13/16"
Length: 15/16"
Chevrolet & GMC Trucks 2003 - On

UNIT PACKAGE: 10



24617
(Ford N803749-S32B; GM 22520702,
15594541; Chrysler 6032268)
Metal

**Door & Quarter Panel, Center Console
& Interior Trim and Cowl Vent Cover,
Instrument Panel Retainer**
GM, Ford, Chrysler

UNIT PACKAGE: 25



20860
(15078238)
Black

**Radiator Grille &
Bumper Cover Fastener**
Width: 5/8"
Length: 1"
Overall Height: 5/8"
GM Trucks & Vans 1999 - On

UNIT PACKAGE: 15



22496
(GM: 11546500)
Black Phosphate

Grille Assembly Clip
Head Size: 17.5mm x 25mm
Overall Height: 19mm
Chevrolet Canyon, Colorado & Silverado
and GMC Sierra 2015 - On

UNIT PACKAGE: 10



25183
(GM: 11519069)
Zinc with Blue Topcoat

Radiator Grill & Quarter Trim Panel Clip
Head Size: 16.5mm x 26.5mm
Overall Height: 15.5mm
Fits into 8mm x 25.4mm Slot
Chevrolet Avalanche 2006 - 2003, Express
Van & GMC Savana Van 2003 - On,
Malibu 2007 - 2004, Silverado,
Suburban 2007 - 2001

UNIT PACKAGE: 15



25190
(GM: 11547155)
Yellow Zinc

**Roof Pillar, Rocker, Quarter Panel,
Liftgate & Interior Trim Fastener**
Width: 12mm
Height: 11.3mm
Buick Enclave 2018 - On; Cadillac CT4,
XT6 2020 - On; Chevrolet Blazer 2020 - On,
Camaro 2016 - On, Corvette 2015 - On,
Equinox, Traverse, Silverado & GMC Terrain 2018- On;
Chevrolet Silverado & GMC Sierra 2019 - On

UNIT PACKAGE: 15



25275
(GM: 11589329; Chrysler: 6511238AA)
Trivalent Yellow Zinc

Pillar Trim Panel & Radiator Grille Fastener
Width: 12mm
Length: 15.5mm
'U' Width: 5mm
Buick Enclave 2020 - 2018, Encore 2020 - On, Envision
2020 - 2016, LaCrosse 2019 - 2017;
Cadillac ATS 2019 - 2015,
CT4, CT5 & XT6 2020 - On, CT6 2020 - 2016,
XT4 2019 - On, XT5 2020 - 2017;
Chevrolet Blazer, Silverado 2019 - On, Bolt 2019 - 2017,
Camaro 2020 - 2016, Colorado 2020 - 2015,
Corvette 2020 - On, Cruze 2018 - 2016,
Equinox 2020 - 2018, Express 2020 - 2019,
Impala 2020 - 2014, Sonic 2020 - 2012,
Trailblazer 2021 - On, Traverse 2020 - 2010,
Trax 2020 - 2017, Volt 2019 - 2016;
GMC Acadia 2020 - 2017, Canyon 2020 - 2015,
Savana 2020 - 2019, Sierra 2019 - On,
Terrain 2020 - 2008; Jeep Gladiator 2020 - On,
Wrangler 2018 - On

UNIT PACKAGE: 50



22477
(Not Available from O.E.M.)
Zinc

Interior Panel Fastener
Width: 10mm
Height: 12mm
GM Silverado 2014 - On

UNIT PACKAGE: 15



19519
(GM: 16662182;
Chrysler: 6502988)
Zinc Organic

**Windshield Garnish Moulding,
Rear Side Door Garnish Moulding
& Liftgate Trim Finish Panel Fastener**
Width: 1/2"
Height: 9/16"
Chevrolet Camaro, Corvette, &
Venture; Oldsmobile Silhouette and
Pontiac Firebird, Grand Prix &
Trans Sport 1993 - On
Chrysler 1996 - On

UNIT PACKAGE: 15



25279
(Chrysler: 68139270AA;
Ford: W715980-S439)
Silver Magni-565

Interior Trim Panel Fastener
Width: 12mm
Length: 15.5mm
'U' Width: 3.8mm
Chrysler 200 2017 - 2015, Pacifica 2017 - On,
Voyager 2020 - On; Dodge Challenger 2018 - On,
Dart 2016 - 2015; Jeep Cherokee 2014 - On,
Wrangler 2020 - On; Ford F150 2015 - On,
F250, F350 2017 - On, Focus 2003

UNIT PACKAGE: 50



25276

(GM: 11602471; Ford W714030-S424)
Black Phosphate

Interior Trim Panel & Cowl Grille Fastener

Width: 12mm
Length: 15.5mm
'U' Width: 5mm

Cadillac CT4 2020 - On;
Chevrolet Silverado 2020 - On;
GMC Sierra 2019 - On; Ford Edge 2014 - 2011,
Expedition 2018 - On, F150, F250 & F350 2015 - On,
Flex 2019 -2009, Mustang Mach-E 2021,
Taurus 2019 - 2013; Lincoln MKS 2016 - 2009,
MKX 2015 - 2011, Navigator 2018 - On

UNIT PACKAGE: 50



25273

(GM: 11570612)
Zinc & Clear

Scuff Plate Fastener

Width: 12mm
Length: 10.7mm
'U' Width: 3.5mm

Chevrolet Camaro 2015 - 2011, Corvette 2019 - 2014,
Equinox & Terrain 2017 - 2010, Silverado &
Sierra 2020 - On; GMC Acadia 2012 - 2007

UNIT PACKAGE: 50



20268

(GM: 11588650, 15748479;
Ford: W704021-S424)
Black

**Garnish Moulding, A-Pillar
& Trunk Trim Fastener**

Width: 1/2"
Height: 5/8"

GM Cars & Trucks 1994 - On; Ford F250,
F350 2016 - 2011; Focus 2011 - 2008;
Mustang 2014 - 2006; Police 2019 - 2013;
Taurus 2019 - 2008; Lincoln MKS 2016 - 2013;
Navigator 2017 - 2007

UNIT PACKAGE: 25



20883

(11588650)
Zinc

**Garnish, Interior Trim, Bezel
& Scuff Plate Fastener**

Width: 15/32"
Height: 11/16"

GM Cars & Light Trucks 2002 - On

UNIT PACKAGE: 10



25274

(GM: 11571016)
Zinc & Blue Topcoat

Cowl Vent Fastener

Width: 12mm
Length: 15.5mm
'U' Width: 5mm

Buick Enclave & Regal 2020 - 2018,
Lacrosse 2019 - 2017; Cadillac ATS 2018 - 2013,
CT4, CT5 & XT6 2020 - On, CTS 2019 - 2012,
Escalade 2020 - 2015, XT5 2020 - 2017;
Chevrolet Blazer 2019 - On, Camaro,
Colorado & Silverado 2017 - On, Captiva 2015 - 2012,
Equinox & Traverse 2020 - 2018,
Malibu 2016 - On, Suburban, Tahoe 2020 - 2015,
Volt 2019 - 2011; GMC Acadia & Sierra 2020 - 2017,
Yukon 2020 - 2015

UNIT PACKAGE: 50



21745

(11609651)
Zinc

**Windshield Garnish and Interior
Trim Moulding Fastener**

Screw Size: M4.2 (#8)
Stem Width: 13mm
Head Size: 13.5mm x 20.5mm
Overall Length: 22mm

Buick Enclave & Encore; Cadillac CTS, Escalade, STS &
XTS; Chevrolet Avalanche, Camaro, Cobalt, Corvette,
HHR, Impala, Malibu, Monte Carlo, Silverado, Suburban,
Tahoe & Traverse; Dodge Truck; Ford Flex & Taurus;
GMC Sierra & Yukon;
Kia Sorento & Soul; Pontiac G6 & G8;
Saturn Outlook and Suzuki Grand Vitara 2004 - On

UNIT PACKAGE: 15



23786

**Door & Quarter Glass
Outer Weather Strip Clip**

GM, Ford & Chrysler
Some Imports

UNIT PACKAGE: 50



25416

(GM: 11603057)
Yellow Nylon

Front Bumper Retainer

Top Head Diameter: 10mm x 12mm
Bottom Head Diameter: 12mm x 16mm
Stem Size: 11mm x 11mm
Overall Length: 21mm
Fits into 8mm x 14mm Slot
Cadillac Escalade 2021 - On;
Chevrolet Suburban, Tahoe 2021 - On;
GMC Tahoe, Yukon 2021 - On;
Hummer 2021-2020

UNIT PACKAGE: 25



18262
(15002520, 15682898)
Zinc Organic

Radiator Grille Retainer
GM Pickup, Van, Blazer,
Jimmy 1994-On

UNIT PACKAGE: 25



24179
(15686142, N802865)
Black Finish

Grille, Bumper & Radiator Support Nut
Screw Size: M4.2

GM & Lincoln 1983 - On

UNIT PACKAGE: 25



21027
(11518531)
Zinc Organic

**Fender Bracket Interior Trim, Door, Bumper
& Hood Retainer Nut**

Screw Size: #8 (M4.2-1.41)

Buick Enclave & Lucerne, Chevrolet Equinox & Malibu,
Hummer and Pontiac G5, G6, G8 & Solstice 2003 - On

UNIT PACKAGE: 15



18153
(11561448, 15686142)
Zinc Phosphate

Radiator Grille Nut
Screw Size: #8

GM Trucks C & K, 1, 2 & 3 1993-On

UNIT PACKAGE: 25



25325
(Chrysler: 68250997AC)
Yellow Nylon

Hood Prop Rod Clip

Holds 7mm Prop Rod
Head Size: 18mm x 25mm
Stem Length: 13.5mm
Overall Height: 29mm
Fits into 9.5mm Slot

Chrysler Pacifica 2017 - On, Voyager 2020 - On;
Jeep Compass 2017 - On

UNIT PACKAGE: 25



22289
(GM: 11570654; Chrysler: 6509432AA
Ford: W716529-S900)
Magni-565 Blue Finish

Radiator Grille Nut

Screw Size: M4.2-1.41 (#8)
Head Size: 6mm x 16mm
Overall Height: 7mm

Buick Allure, Enclave, Encore, LaCrosse,
Lesabre, Lucerne, Rainer, Regal & Verano and
Cadillac ATS, CTS, Deville, DTS, ELR,
Escalade, SRX & STS 2000 - On
Chrysler 200, 300, PT Cruiser, Sebring, Town & Country
and Dodge Avenger, Caliber, Charger, Dart, Grand
Caravan, Ram 2500 & Ram 3500 2015 - 2006
Ford 250, 350, 450 & 550 Super Duty Trucks 2015 - 2013

UNIT PACKAGE: 25



22886
(GM: 11548673)
Magni-565
Green Plating

Radiator Shield Nut

Screw Size: M4.2-1.41 (#8)
Head Size: 13.5mm x 24mm
Stem Length: 10mm

Buick Cascada, Enclave,
Envision & LaCrosse,
Cadillac CT6, XT5 & XTS 2016 - On

UNIT PACKAGE: 25



21754
(11609952)
Magni-565 Plating

Front Bumper Specialty Nut

Screw Size: M4.2-1.41 (#8)
Head Size: 6mm x 16mm
Overall Height: 7mm

Cadillac Escalade, Chevrolet Tahoe
and GMC Yukon 2007 - On

UNIT PACKAGE: 25



21524
(11610157)

Zinc Organic

**Center Console Door, Front Lights,
Grille, Instrument Panel & Lift Gate
Nut with Silicone Pad**

Screw Size: M4.2-1.41 (#8)

Cadillac CTS, Chevrolet Corvette, Equinox,
Malibu & Traverse, Hummer H3, Pontiac G6
and Saturn Ion 2003 - On

UNIT PACKAGE: 10



21753
(11562503)

Zinc Organic

Specialty Nut with Plastisol Pad

Screw Size: M6-1.0

Head Size: 13mm x 13mm

Stem Length: 8mm

Chevrolet Truck & GMC 2008 - On

UNIT PACKAGE: 10



22491

(Ford: W717086-S439, GM: 11547582)
Zinc Organic

**Air Duct & Rear Bumper Bracket, Tail
Gate, Engine Under Cover Nut**

Thread Size: M6-1.0

Head Size: 8mm x 18mm

Overall Height: 11mm

Cadillac CT6, Chevrolet Silverado and GMC
Acadia & Sierra 2016 - On; Ford Edge, F-150
Mustang 2015 - On, Expedition 2018 - On, F-250,
F-350, F-450, F-550 2017 - On; Lincoln
Continental 2020 - 2017, Corsair 2020 - On,
MKC 2019 - 2015, MKX 2018 - 2016, Nautilus 2019,
Navigator 2018 - On

UNIT PACKAGE: 25



14820
(GM: 14083173,
17988488, 17997722,
Ford: N803685S)
Phosphate

Dash Panel Nut
Screw Size: #8 (M4.2-1.41)
GM & Ford 1982-On
UNIT PACKAGE: 25



22410

(GM: 11610544)
Zinc Organic

Front Fender Panel Nut
Screw Size: M6-1.0
Overall Height: 12mm
Buick Allure, LaCrosse &
Regal 2012 - On
UNIT PACKAGE: 10



24525

(10056725)
Metal

**Door Pull Strap &
Rear Speakers Panel Fastener**
Screw Size: #8
Hole Size: 8mm x 8mm
GM 1988 - On
UNIT PACKAGE: 25



19317

(15707256)
Zinc Organic

**Front Fender Extension & License
Plate Bracket Retainer Nut**
Screw Size: M6-1.0
GM Express & Savanna 1996-On
UNIT PACKAGE: 10



22117

(11518937)
Zinc Organic

Radiator Grille & Front End Panel Nut
Thread Size: M6-1.0
Overall Height: 11mm
Buick Allure & LaCrosse, Chevrolet Impala &
Monte Carlo, GMC Sierra & Yukon and
Pontiac Grand Prix 2004 - On
UNIT PACKAGE: 10



23461

(11517769)
Phosphate Zinc Organic
240 hr. Salt Spray

Door Trim Panel Retainer Nut
Screw Size: M6-1.0
Overall Height: 11mm
Fits into 12.5mm x 20mm Hole
GM Cars & Lt. Duty Trucks
1999 - On

UNIT PACKAGE: 5



22538

(GM: 11570015)
Zinc Organic

**Front & Rear Bumper and Headlamp
Assembly Specialty Push-In Nut**

Thread Size: M6-1.0
Overall Height: 11.6mm
Buick Cascada, Envision, LaCrosse & Regal, Cadillac
ATS, CT6, CTS, ELR, Escalade & XTS, Chevrolet Camaro,
Colorado, Cruze, Malibu, Silverado, Sonic, Suburban,
Tahoe & Volt and GMC Acadia 2011 - On
UNIT PACKAGE: 10



25446

(GM: 24441317)
Zinc Finish

Fender Apron Snap-in-Nut

Screw Size: M4.2-1.41
Head Size: 18mm x 23mm
Stem Length: 7mm
Fits into 11mm Slot
Buick Allure 2021 - 2010, Cascada 2016,
LaCrosse 2012 - 2010, Regal 2021 - 2011;
Cadillac ELR 2016 - 2014; Chevrolet Cruze 2015 - 2011,
Impala 2016 - 2015, Orlando 2014 - 2012, Volt 2019 - 2011;
Saturn Astra 2009 - 2008
UNIT PACKAGE: 25



22277

(11547446)
Black Finish

Door Panel Clip

Head Size: 16.5mm x 25mm
Stem Length: 13mm
Chevrolet Colorado, Silverado,
Suburban & Tahoe and GMC Canyon,
Sierra & Yukon 2015 - On
UNIT PACKAGE: 10



25407

(Ford: W719534-S300)
Black Nylon

Splash Shield Nut

Thread Size: M6
Flange O.D.: 30mm
Hex Size: 10mm
Height: 15mm
Ford Explorer &
Lincoln Aviator 2020 - On
UNIT PACKAGE: 25



20396

Yellow Zinc

1/4" - 20 Specialty Insert
Grip: .030" - .165"
Head Diameter: 1/2"
Hex Size: 3/8"

Can be set with Auveco tool 11805
UNIT PACKAGE: 15



20742

Yellow Zinc

M4-.7 Specialty Insert
Grip: 2mm - 3.3mm
Head Diameter: 9.5mm
Hex Size: 6.2mm

Can be set with Auveco tool 11805
UNIT PACKAGE: 15





20678

Yellow Zinc

M5-.8 Specialty Insert
Grip: .5mm - 3.3mm
Head Diameter: 10mm
Hex Size: 7mm

Can be set with Auveco tool 11805

UNIT PACKAGE: 15



19220

(10237960)

Yellow Zinc

M6-1.0 Specialty Insert
Grip: .7mm - 4.2mm
Head Diameter: 12.5mm
Inside Door Handle, Window Regulator &
Air Bag Module Attachment
Chevrolet Lumina, Monte
Carlo & Pontiac Grand Prix 1995-On
Can be set with Auveco tool 11805

UNIT PACKAGE: 25



20415

(GM: 15685099;
Ford: N803763-S100)
Yellow Zinc

M6-1.0 Specialty Insert with Sealer
Grip: .65mm - 2.0mm
Head Diameter: 12mm
Hex Size: 8mm

Roof Rack, Tailgate & General Purpose GM APV Vans, C
& K Trucks and Ford Explorer 1991 - On
Can be set with Auveco tool 11805

UNIT PACKAGE: 15



20395

(10281487)

Yellow Zinc

M6-1.0 Specialty Insert
Grip: .7mm-4.2mm
Head Diameter: 13mm
Hex Size: 9.5mm (3/8")
Front Fender

Buick, Cadillac, Corvette, L.D. Truck, Olds
Aurora and Pontiac 1997 - On
Can be set with Auveco tool 11805

UNIT PACKAGE: 15



20422

(11519952)

Zinc

M6-1.0 Specialty Insert
Grip: .7mm-4mm
Head Diameter: 13mm
Hex Size: 9.5mm (3/8")

Front Core Support & General Purpose
GM Envoy & Trailblazer 2002 - On
Can only be set with Pneumatic tool

UNIT PACKAGE: 15



22035

(11609292)

Zinc

M6-1.0 Specialty Insert with Sealer
Grip: .5mm - 4.2mm
Head Diameter: 13mm
Hex Size: 9.5mm
Roof Rack & Luggage Carrier
Buick, Chevrolet, GMC,
Hummer & Saturn 2012 - 06
Can be set with Auveco tool 11805

UNIT PACKAGE: 10



22121

(11609836)

Tin-Zinc Finish

Specialty Insert
Thread Size: M8-1.25
Grip Range: .70mm - 3.80mm
Head Diameter: 17mm

Hex Size: 12.5mm

General Purpose

Cadillac XLR &

Chevrolet Corvette 1997 - On

Can only be set with Pneumatic tool

UNIT PACKAGE: 10



20423

(11519960)

Zinc

M8-1.25 Specialty Insert

Grip: .7mm-4mm

Head Diameter: 17mm

Hex Size: 12.5mm (1/2")

Front Core Support & General Purpose

GM Envoy & Trailblazer 2002 - On

Can only be set with Pneumatic tool

UNIT PACKAGE: 15



15459

(1247872, 15567924)

Throttle Rod Retaining Clip
For 1/4" Rod with 5/32" Groove
Outer Diameter: 19/32"
GM 1975-On

UNIT PACKAGE: 50



9367

(4495047)

Front Seat Arm Support
Hinge Pin Retainer
GM

UNIT PACKAGE: 100



21351
(11588441)
Zinc

**Fender, Quarter Panel & Grille
Push-On Retainer**
Stud Size: 6mm
Outer Diameter: 24mm
GM & Hummer 2002 - On

UNIT PACKAGE: 50

21290

(Retainer: 15769308, Ring: 15040331)
Zinc

Photos not actual size



**Spare Tire Lock Cylinder Housing Retainer
& Lock Ring Kit**

Retainer Outer Diameter: 72mm
Lock Ring Outer Diameter: 57mm
GM C/K, Denali, Sierra, Silverado, Suburban,
Tahoe and Yukon 1999 - On

UNIT PACKAGE: 5 Kits



20562
(9601750)

**Door Lock Striker
Bolt Assembly
with PVC Plastic Bushing**
Thread: 1/2" - 13
Overall Length: 2-1/4"
GM Cars &
Trucks 1991 - 73

UNIT PACKAGE: 1



Left-Hand Side

10262
Nylon

**Door Lock Rod & Hood
Latch Locking Push Rod Clip**
Rod Size: 5/32"
Fits into 1/4" Hole
Chrysler, Ford, GM & AMC

UNIT PACKAGE: 20 Pieces
10 Rights - 10 Lefts



Right-Hand
Side



20675

(AMC: 4003672R;
Chry: 2945108R, 4658676;
GM: 16627328, Ford: N805350S)
White Nylon

Clip for Right-Hand Side Only

UNIT PACKAGE: 25



14967

(AMC: 4003673L;
Chry: 2945109L, 4658677;
GM: 9815325, 16607593;
Ford: D2VZ-6521952A, N804344S)
Black Nylon

Clip for Left-Hand Side Only

UNIT PACKAGE: 50



18392
(20582532)
Black Nylon

Door Lock Rod Clip
Rod Size: 5/32"

Buick Regal & Roadmaster Chevrolet Caprice,
Olds Custom Cruiser & Cutlass and
Pontiac Grand Prix 1992-On

UNIT PACKAGE: 25



18393
(20582533)
Natural Nylon

Door Lock Rod Clip
Rod Size: 5/32"

Buick Regal & Roadmaster Chevrolet Caprice,
Olds Custom Cruiser & Cutlass and
Pontiac Grand Prix 1992-On

UNIT PACKAGE: 25
10 Rights - 10 Lefts



25266

(Chrysler: 68294220AC)
Yellow Nylon

Hood Prop Rod Clip
Holds 7mm Prop Rod
Head Size: 25mm x 31mm
Stem Length: 13.5mm
Overall Height: 29mm
Fits into 9mm Slot
Jeep Gladiator 2020 - On,
Wrangler 2018 - On

UNIT PACKAGE: 25



25053

(GM: 22755704)
Black Rubber

Hood Prop Buffer

Overall Width: 20mm
Overall Height: 27mm
Fits into 11mm Slot
Chevrolet Silverado 2014 - On;
GMC Sierra 2018 - On;
Yukon 2015 - On

UNIT PACKAGE: 25



15673

(GM: 8891031;
Chrysler: 3454220, 4658676)
Red Nylon

**Door Lock Rod Clip
Used on Right-Hand Side**

Rod Size: 5/32"
GM C & K Pickups 2007 - 1999
Chrysler 1972 - On

UNIT PACKAGE: 50



15674

(GM: 8891030;
Chrysler: 3454221, 4658677)
Green Nylon

**Door Lock Rod Clip
Used on Left-Hand Side**

Rod Size: 5/32"
GM C & K Pickups 2007 - 1999
Chrysler 1972 - On

UNIT PACKAGE: 50



22453

(GM: 12375975)
Pink Nylon

Rear Cargo Door Latch Rod Clip

Rod Size: 4mm
Fits into 6mm Hole
Cadillac Escalade, Chevrolet Astro,
Express Van, Suburban & Tahoe and
GMC Safari, Savana, & Yukon 1996 - On

UNIT PACKAGE: 15



21196

(16630688)
White Nylon

Door Lock Rod Clip

Used on Right-Hand Side
Rod Size: 3/16" (5mm)
GM Pick-Up Trucks 1999 - On

UNIT PACKAGE: 25



21197

(16630689)
Black Nylon

Door Lock Rod Clip

Used on Left-Hand Side
Rod Size: 3/16" (5mm)
GM Pick-Up Trucks 1999 - On

UNIT PACKAGE: 25



18926

(14037239, 15545178)
Natural Nylon

Tailgate Rod Clip

Rod Size: 3/16"
GM Trucks C, K 1, 2, 3 1981-On

UNIT PACKAGE: 10



19658

(16629990, 16675980)
Gray Nylon

Door Lock Rod Clip

Rod Size: 5/32"
Buick, Cadillac, Chevrolet, Oldsmobile,
Pontiac & Trucks 1996 - On

UNIT PACKAGE: 15



15518

(4234830, 12337868)

Door Lock Rod Clip

GM 1964-On

UNIT PACKAGE: 25



15759

(3998009, 9711304)

Door Lock Rod Clip

GM 1956-On

UNIT PACKAGE: 50

Door Hinge Pin & Bushing Repair Kits

Photos not actual size

**GM Truck
Door Hinge Pin & Bushing Repair Kits**

Why bother with the hassle of cutting and grinding off a worn door hinge and welding on a new one when you can repair the bad hinge in a fraction of the time?

With our Door Hinge Pin & Bushing Repair Kits, fixing sagging doors caused by worn hinges due to pin failure is quick. It's easy. It works. And you don't have to repaint the welded heat flash area.

Each kit is designed to repair one hinge and contains all the pins, bushings and related hardware to do the job.

Refer to Kit listings below and on following pages.

Photos not actual size.

Here's how it works:

1. Remove the door from the truck body
2. Remove the original equipment pin and bushings
3. Install the bushings into the hinge holes
4. Install the longer pin into the top hinge hole
5. Thread on the lock nut
6. Install the shorter pin into the bottom hinge hole
7. Place the washer and a nut on the shorter pin
8. Tighten the nut to pull the pin into place.
9. Slowly tighten both upper and lower lock nuts
10. Reattach the door to the truck body

Detailed instructions are included with the kit.



20485
(89025539)

Door Hinge Pin and Bushing Kit
Cadillac Escalade 2006 - 2000
Chevrolet Silverado & GMC Sierra:
1500/2500, HD / 3500, HD
2007 - 1999

Chevrolet Suburban
1500/2500 &
Tahoe 2006 - 2000
GMC Yukon
2006 - 2001

UNIT PACKAGE: 1 Kit



21644

(12338074, 15562609, 15562610, 15591860, 15691493,
15691595, 15964971, 15964972, 15967691, 16632192,
16632193, 88891731)

Door Hinge Pin & Bushing Kit

Repairs One Hinge
Contains one Auveco pin 19424, one each of
Auveco bushings 16936 & 16937
GM C & K Trucks 1988 - On

UNIT PACKAGE: 1 Kit



21072
(89025546)

**Greaseable
Stainless Steel
Side Cargo Door
Hinge Pin &
Bushing Kit**
GM Savana Van &
Express Van
2008 - 1996

UNIT PACKAGE: 1 Kit



21404
(19260058)

**Greaseable Stainless Steel
Door Hinge Pin, Bushing & Bracket Repair Kit**
Repairs One (Upper or Lower)
Passenger's Side Hinge

Cadillac Escalade 2006 - 2002
Chevrolet Avalanche 2006 - 2002
Chevrolet Silverado 2006 - 1999
Chevrolet Silverado Classic 2007
Chevrolet Suburban 2006 - 2000
Chevrolet Tahoe 2005 - 2000; GMC Sierra 2006 - 1999
GMC Sierra Classic SLE 2007; GMC Yukon 2002
GMC Yukon Denali 2004 - 2001
GMC Yukon S 2006 - 2005 ; GMC Yukon SLE 2000

UNIT PACKAGE: 1



21610

(12338074, 15562609, 15562610, 15653790, 15691493,
15964971, 15964972, 16632192 & 16632193)

Door Hinge Pin & Bushing Kit
Repairs one Hinge
Contains one Auveco 19781 pin,
one each of Auveco bushings
16936 & 16937

GM S & T Trucks 1994 - On

UNIT PACKAGE: 1 Kit

Door Hinge Pin & Bushing Repair Kits

Photos not actual size

21405



Stainless Steel
Door Hinge Pin & Bushing Repair Kit
Repairs Two Hinges

Cadillac Escalade & Escalade ESV; Chevrolet
Avalanche 4-door pickup/SUV, Silverado, Suburban
4-door extended SUV, & Tahoe 4-door SUV;
GMC Sierra, Yukon & Yukon XL 2013 - 2007

UNIT PACKAGE: 1

21406

(19260061)



Greaseable Stainless Steel
Door Hinge Pin & Bushing Repair Kit
Repairs Two Hinges

Cadillac Escalade & Escalade ESV; Chevrolet
Avalanche 4-door pickup/SUV, Silverado, Suburban
4-door extended SUV, & Tahoe 4-door SUV;
GMC Sierra, Yukon & Yukon XL 2013 - 2007

UNIT PACKAGE: 1



21487

(19260056)

Greaseable Stainless Steel
Door Hinge Pin & Bushing Repair Kit
Repairs One Front
(Upper or Lower)
Door Hinge
Buick Rainier,
Chevrolet Trailblazer
and GMC Envoy
2011 - 02

UNIT PACKAGE: 1

22174

(19332887)



Greaseable Stainless Steel
Door Hinge Pin and Bushing Repair Kit
Repairs Two Hinges
GMC Full Size Pick-Ups & SUV's 1998 - 1988

UNIT PACKAGE: 1

24581



Door Roller Pin Assembly
Length: 5-1/2"
Pin Diameter: 9/16"
Knurl Diameter: 19/32"
Roller Groove: 5/8"
Roller O.D.: 3/4"
Gm Ck 1,2,3 Trucks 1988 - On

UNIT PACKAGE: 1

Door Hinge Pin & Bushing Repair Kits

Photos not actual size

19782
(15672183)
Zinc

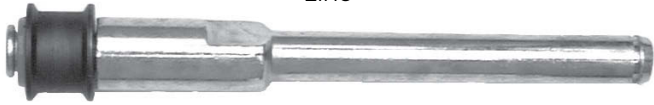

Door Hinge Roller Pin Assembly

Pin Diameter: 25/64"
Overall Length: 5-1/16"
Roller Outer Diameter: 3/4"
Roller Groove Diameter: 5/8"

Use with Auveco 8829 E-Type Retaining Ring
Rear Door Upper Hinge S & T Trucks 1994 - On

UNIT PACKAGE: 1

19781
(15653790)
Yellow Zinc



Door Hinge Pin

Length: 4-1/8"
Pin Diameter: 11/32"
Shoulder Outer Diameter: 3/8"
Head Outer Diameter: 1/2"

Use with Auveco Bushings 16936 & 16937
S & T Trucks 1994 - On

UNIT PACKAGE: 2

24476

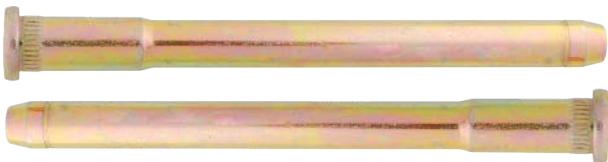

Door Hinge Pin & Bushing Kit

Contains: Two 19781 (2896) Door Hinge Pin,
16937 (2740) Lower Bushing,
16936 (2741) Upper Bushing,
& 8829 (2648) E Type Retaining Ring
GM S&T Trucks

UNIT PACKAGE: 2

14559

(6271989, 20046147)
Phosphate



Door Hinge Pin

Length: 4-1/16"
Pin Diameter: 11/32"
Head Outer Diameter: 9/16"

Buick Estate Wagon & LeSabre Wagon 1990-1982,
Electra 1982, Regal 1987 - 1982, Riviera 1985 - 1982,
and all exc. Skyhawk 1977 - 1976;
Cadillac Cimarron 1988-1982,
Eldorado & Seville 1985-1982,
Fleetwood Brougham 1992-1982;
Chevrolet Camaro 81-78, C & K Trucks 1984 - 1973
Monte Carlo, Malibu & El Camino 1988-1976,
Impala & Caprice 1990-1982, Nova 1979-1977;
Oldsmobile Cutlass Supreme, Calais &
Cruiser 1988-1976, Delta 88 1990-1977,
Omega 1979-1977, Toronado 1985-1982,
98 Recency 1982-1977; Pontiac Firebird 1981-1978,
Grand Prix 1987-1977, LeMans &
Grand Am 1981-1977 Phoenix & Ventura 1979-1977,
Safari & Parisienne 89-83

UNIT PACKAGE: 10

23761
(9806723)



Door Hinge Pin

Head Diameter: 1/2"
Pin Diameter: 5/16"
Diameter: 11/32"
Length: 2-13/16"
Knurl Diameter: 0.351 - 0.357"
GM Cars: 'B' 1977 - 1979
'K' & 'X' 1976 - 1979

UNIT PACKAGE: 25

19424

(15591860; 15691595;
5967691; 88891731)
Stainless Steel



Door Hinge Pin

Length: 5-1/4"
Pin Diameter: 11/32"
Shoulder Outer Diameter: 3/8"
Head Outer Diameter: 9/16"
GM Trucks

Use with Auveco Bushings 16936 & 16937
C-K Models 1988-On

UNIT PACKAGE: 4

Photos not actual size

17437

(12338015, 14066728)
Yellow Zinc



Door Hinge Pin

Length: 4-5/32"
Pin Diameter: 11/32"
Head Outer Diameter: 15/32"
GM Astro Van, Safari Van & S-10 1982-On

UNIT PACKAGE: 5

WARNING: Reproductive Harm & Cancer
www.P65Warnings.ca.gov

24549



Door Pin & Bushing Kit

Contains Two Pins, Four Bushings
& Two Retainers
GM Full Size Vans, Hinged Side Door
Chevy Express/GMC Savana 1996-2006

UNIT PACKAGE 2

24511



Door Hinge Pin & Bushing Kit

Contains: Two 17437 (2944) Door Hinge Pin
& 14553 (2284) Bushings
GM Astro Safari Van & S-10 Truck

UNIT PACKAGE: 2

14548

(9822198)



Photo actual size

Inner Diameter: 3/8"
Outer Diameter: 1/2"
Height: 15/32"
Flange Outer Diameter: 5/8"
Buick 1975-42
Chevrolet: Monza & Vega 1980-76,
All (Exc. Corvette) 1975-62, Olds Starfire 1980-76
Pontiac: Astre & Sunbird 1980-76 and All 1975-49

UNIT PACKAGE: 25

14549

(9716926, 20345137)



Photo actual size

Thick Bushing

Inner Diameter: 11/32"
Outer Diameter: 1/2"
Height: 3/8"
Flange Outer Diameter: 19/32"
Buick 1976-On
Cadillac 1980-On
Chevrolet: All 1976-On, Corvette 1982-73
Olds (Exc. Starfire) 1980-On
Pontiac: Exc. Astre & Sunbird 1980-On

UNIT PACKAGE: 25

14550

(GM: 9721917;
Ford: DIAZ-6522841A)



Photo actual size

Inner Diameter: 11/32"
Outer Diameter: 27/64"
Height: 19/64"
Flange Outer Diameter: 19/32"
Buick (Exc. Skyhawk) 1967-On
Cadillac 1946-On
Chevrolet: Exc. Monza & Vega 1962-On,
Corvette 1956-On, GM C & K Trucks 1993 - 79
Olds Exc. Starfire 1949-On
Pontiac: Exc. Astre & Sunbird 1932-On

UNIT PACKAGE: 25

14553

(20429500)



Inner Diameter: 11/32"
Outer Diameter: 31/64"
Height: 23/64"
Flange Outer Diameter: 19/32"
Splined Outer Diameter
All GM (Including Pick-Ups & Vans)
1968-On

UNIT PACKAGE: 25

16936

(12338074, 15691493,
15964971 & 16632193)



Inner Diameter: 11/32"
Outer Diameter: 1/2"
Height: 23/64"
Flange Outer Diameter: 43/64"
Splined Outer Diameter
Side Door Upper Hinge
GM Trucks C-K Models 1988-On

UNIT PACKAGE: 25

Photos not actual size



16937

(15562609, 15964972 & 16632192)

Inner Diameter: 25/64"
Outer Diameter: 17/32"
Height: 23/64"
Flange Outer Diameter: 11/16"
Splined Outer Diameter
Side Door Lower Hinge
GM Trucks C-K Models 1988-On

UNIT PACKAGE: 25

23742

(20099254)

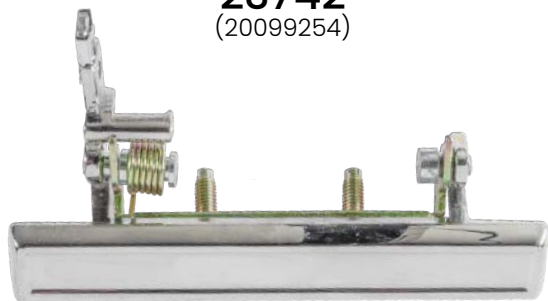

Outside Door Handle
Right Hand

Chevrolet, Olds & Pontiac "F", "H", & "B" Bodies, Camaro & Firebird 1975 - 1981

UNIT PACKAGE: 1

23735

(14011820)



Outside Door Handle
Right Hand
Corvette 1969 - 1983

UNIT PACKAGE: 1

23736

(14011819)



Outside Door Handle
Left Hand
Corvette 1969 - 1983

UNIT PACKAGE: 1

23727



Vent Window
Regulator Handle
GM 1949 - 1966
UNIT PACKAGE: 6

23754

(7743519)



Door Opener Handle
Chevrolet & GMC Trucks
& Vans 1968 - 1996
UNIT PACKAGE: 6

23726

(4619387)



Window Regulator
Handle
GM 1949 - 1966
UNIT PACKAGE: 6

23727



Vent Window
Regulator Handle
GM 1949 - 1966
UNIT PACKAGE: 6

12314

(20037597)



Photo not actual size
Clear Knob
GM 1952-On
UNIT PACKAGE: 1

⚠ WARNING: Reproductive Harm & Cancer
www.P65Warnings.ca.gov

Photos not actual size



12315
(1732326)

Photo not actual size
Black Knob
GM 1952-On

UNIT PACKAGE: 1

⚠ WARNING: Reproductive Harm & Cancer
www.P65Warnings.ca.gov



23755
(3725377)

Window Regulator Handle
Chrome Knob
Corvette 1955 - 1967

UNIT PACKAGE: 6



23753

Vent Window
Regulator Handle
Chrome Knob
Corvette 1963 - 1964

UNIT PACKAGE: 6

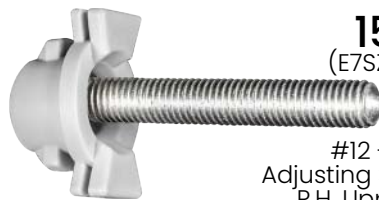

FORD

15966
(E7SZ-13032-D)

#12 -28 x 1-1/2"
Adjusting Screw Assembly
R.H. Upper, L.H. Lower
Phillips Drive
T-Bird, Cougar & Continental 1988-87

UNIT PACKAGE: 5

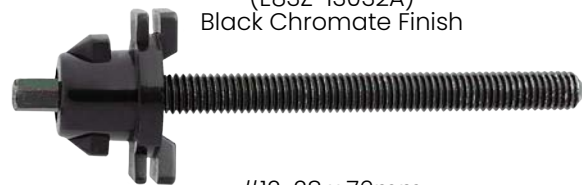

24149
(E83Z-13032A)

Black Chromate Finish

#12-28 x 76mm
Headlight Horizontal Adjusting Pivot Nut & Screw
Tempo, Topaz 1988 - 1991

UNIT PACKAGE: 5



24150
(E83Z-13032B)

Black Chromate Finish

#12-28 x 63.5mm
Headlight Vertical Adjusting Pivot Nut & Screw
Tempo, Topaz 1988 - 1991

UNIT PACKAGE: 5



16399

(E9TZ-13032B,
E97B-13A093BA)
Black Screw

Bronco & Ranger 1989-On

UNIT PACKAGE: 5



11660

(DOZB-13A-093-AA)
Zinc Screw & Phosphate Plate

1/4"-28 x 2"
Headlight Adjusting Screw
& Nut Assembly
Ford Cars & Medium Duty Trucks
1973-On

UNIT PACKAGE: 10

11661

Same as 11660 except for unit package quantity
UNIT PACKAGE: 25

23286
(J01973)



Headlight Adjusting Screw
GM 1965 - 1967
Ford 1965 - 1966
Universal for Other Cars

UNIT PACKAGE: 50

23288



1/4"-28 x 1 1/2"
Headlight Adjusting Nut & Screw
Ford 1961 - 1972

UNIT PACKAGE: 100



15940

(E9DB-13N020AA,
E9DZ-13NI29A)

**Headlight Component
Pivot Retaining Clip**
Ford Taurus & T-Bird and
Mercury Cougar & Sable
1989-On

UNIT PACKAGE: 25



24595

**Headlight
Adjusting Spring**
Ford Mustang, Grand
Torino 1974 - 1975

UNIT PACKAGE: 10



10305

White Nylon

Nylon Nut
Screw Size: #8

UNIT PACKAGE: 50



9862

(379830-S)
White Nylon

Headlight Door, Grille & Mirror Nut
Screw Size: #8 or #10
Fits into 1/4" Square Hole
Ford

UNIT PACKAGE: 50



14756

(Ford: 379830-S; Chry: 6033677)
Black Nylon

Screw Size: #8
Width: 3/8"
Length: 3/8"
Fits into 9/32" x 9/32" Hole
Panel Thickness: 1/4"
Ford & Chrysler 1986-On

UNIT PACKAGE: 25



20245

(N806334-S,
W707157-S300)
Natural Nylon

Nylon Nut
Screw Size: M4.2 (#8)
Head Size: 10mm x 10mm
Fits into 6mm Square Hole
Ford 1999 - On

UNIT PACKAGE: 50



18383

(W700566-S300)
Natural Nylon

Screw Size: #12
Back Panel Attachment
Contour & Mystique 1995-On

UNIT PACKAGE: 25



11865

(GM: 1255823; Ford: 389360S)
Natural Nylon

Tail Light Nut
Screw Size: #6 or #8
Ford 1981-On
Front End Bezel Nut
GM 1979-On

UNIT PACKAGE: 50



12569

(Ford: N801706-S; Chry: 6501773)
Black Nylon

Screw Size: #12
Ford 1981-On

UNIT PACKAGE: 25



14754

(N802376-S)
Blue Nylon

Screw Size: #8
Width: 3/8"
Length: 1/4"
Panel Thickness: 5/32"
Fits into 1/4" Square Hole
Ford

UNIT PACKAGE: 25



22701

(Ford: W711612-S300)
White Nylon

Grille Trim Screw Grommet
Screw Size: M4.2 (#8-18)
Head Diameter: 12.75mm
Stem Length: 5mm
Fits into 7.87mm Square Hole
Overall Height: 9mm
Ford Ranger 2011 - 2004
F-150 2015 - On

UNIT PACKAGE: 25



20927

(N811478-S100)
Black Nylon

License Plate & Rear Bumper Nylon Nut with Sealer
Screw Size: M6.3 (#14)
Head Size: 16mm x 16mm
Stem Length: 8mm
Fusion & Mustang 2005 - On

UNIT PACKAGE: 15



21368

(W711079-S300)
Black Nylon

Tail Light Grommet
Head Size: 13mm x 17mm
Stem Length: 10mm
Explorer, Mountaineer & Pick-Up Trucks
2006 - On

UNIT PACKAGE: 25



19277

(N804765-S)
Natural Nylon

Wheel Opening Screw Grommet
Screw Size: #8 (M4.2)
Head Size: 3/8" x 3/8"
Stem Length: 7/8"
Mustang, T-Bird, Cougar &
Continental 1993-On



UNIT PACKAGE: 50



22723

(Ford: W706436-S300)
White Nylon

Tail Lamp Screw Grommet with Sealer
Screw Size: M4.8 (#10)
Head Diameter: 16mm
Stem Length: 27mm
Overall Height: 28.5mm
Fits into 8mm Square Hole
Ford Focus & Transit 2013 - On

UNIT PACKAGE: 25



25217

(Chrysler: 6507009AA; Ford: W712990-S300)
White Nylon

Door Trim Panel Grommet with Sealer

Screw Size: M4.2 (#8)
Head Size: 15mm x 15mm
Stem Length: 20mm
Overall Height: 21mm
Fits into 9mm Sq. Hole
Chrysler Aspen 2009 - 2007; Dodge Durango
2009 - 2004; Jeep Commander 2010 - 2006,
Grand Cherokee 2007 - 2003, Liberty 2007
- 2002, Wrangler 2007 - On; Ford Taurus,
Taurus X & Mercury Sable 2009 - 2008

UNIT PACKAGE: 25



21826

(W711031-S300)
Black Nylon

License Plate & Tail Light Screw Grommet with Sealer
Screw Size: M6.3 - 1.81 (#14)
Head Size: 15mm x 15mm
Stem Length: 22mm
Ford Edge, Explorer, Fiesta,
Flex, Focus, Fusion & Lincoln 2014 - 06

UNIT PACKAGE: 15



25088

(Ford: W714172-S300)
Grey Nylon

License Plate Mounting Grommet with Sealer
Screw Size: M6
Head Size: 15mm Sq.
Stem Length: 23mm
Overall Height: 26mm
Fits into 10mm Sq. Hole
Ford C-Max 2018 - 2013; EcoSport 2018;
Edge 2019 - 2016; Explorer 2011 - On;
Focus 2018 - 2012; Mustang 2015 - On;
Taurus 2009; Lincoln Corsair 2021 - 2020;
MKS 2016 - 2009; MKX 2018 - 2016; Sable 2009

UNIT PACKAGE: 15



21239

(W708319-S300)
White Nylon

Front Bumper Screw Grommet with Sealer
Screw Size: M4.8 (#10)
Head Diameter: 16mm
Stem Length: 24mm
Fusion 2009 - On

UNIT PACKAGE: 25



24606

Door Trim Screw Grommet
 Head Size: 22.5mm
 Hole Size: 12mm
 Overall Length: 21mm
 Ford Contour & Mystique

UNIT PACKAGE: 25



22928

(Ford: W711501-S300)
 Natural Nylon

**Front & Rear Door Panel
 Screw Grommet**
 Screw Size: M5
 Head Diameter: 22mm
 Stem Length: 12.5mm
 Fits into 9.4mm Sq. Hole
 Ford Ranger 2019 - On

UNIT PACKAGE: 25



11841

(N-800503S)
 Black Nylon

Grille Attachment Nut
 Screw Size: #6
 Ford 1978-On

UNIT PACKAGE: 50



21165

(W712160-S300)
 Black Nylon

Headlight Grommet
 Screw Size: M6 (#14, 1/4")
 Head Size: 22mm x 23.5mm
 Overall Height: 18mm
 Expedition, F150 and
 Navigator 2003 - On

UNIT PACKAGE: 15



20466

(GM: 25649667;
 Ford: W705590-S300,
 W710549-S300)
 Natural Nylon

**Screw Grommet
 With Sealer**
 Screw Size: M4.2 (#8)
 Head Size: 13mm x 22mm
 Stem Length: 18mm
 Back Glass Moulding & Interior Trim
 Cadillac & Ford Windstar 1998 - On

UNIT PACKAGE: 15



21300

(Ford: 3M8Z-17C432-A;
 Mazda: GK2A-50-798)
 White Nylon

**Cowl Vent Screw
 Grommet with Sealer**
 Screw Size: M4.8 (#10)
 Head Size: 15mm x 27mm
 Stem Length: 13mm
 Fusion, Milan, MKZ & Zephyr
 and Mazda 6 2003 - On

UNIT PACKAGE: 5



21224

(F50Y-14603-A)
 Black Nylon

**Headlight and
 Tail Light Grommet**
 Head Size: 18.5mm x 21.5mm
 Stem Length: 18mm
 Fits into 9.5mm x 21.5mm Hole
 Explorer, Navigator and
 Super Duty Pick-Up 2003 - On

UNIT PACKAGE: 25



22475

(Ford: W718369-S300)
 Black Nylon

Rear Lamp Grommet with Sealer
 Head Diameter: 18mm
 Stem Length: 13mm
 Overall Length: 15.6mm
 Ford F-150 2015 - On

UNIT PACKAGE: 10



22474

(Ford: W717970-S300)
 Black Nylon

Rear Lamp Grommet
 Head Diameter: 18mm
 Stem Length: 16mm
 Overall Length: 18mm
 Ford F-150 2015 - On

UNIT PACKAGE: 10



22914

Ford: W717430-S300
 Natural Nylon

Tail Lamp Grommet with Sealer
 Head Diameter: 18mm
 Stem Length: 14.5mm
 Fits into 8mm Hole
 Overall Length: 15.5mm
 Ford Focus 2018 - 2015
 Edge, Ranger and
 Lincoln Nautilus 2019 - On
 Bronco 2021 - On

UNIT PACKAGE: 10



22916

Ford: W718155-S300
Black Nylon

Tail Lamp Assembly Grommet

Head Diameter: 18mm
Stem Length: 16mm
Fits into 8mm x 10mm Hole
Overall Height: 17.5mm
Ford Edge & Ranger and
Lincoln Nautilus 2019 - On
Lincoln MKX 2018 - 2016
Escape 2020 - On
Bronco 2021 - On

UNIT PACKAGE: 10



23699

(D9BZ-5402316-A)

Dash Panel & Grille Retaining Grommet

Screw Size: M4.2
Fits in 7mm Hole
Ford Full Size Cars, Ranger, Aerostar,
Explorer & "E" Vans 1979 - On

UNIT PACKAGE: 50



20264

(N806363-S)
White Nylon

Kick Panel Grommet
Head Diameter: 23mm
Overall Length: 24mm
Used with Auveco Retainer 19760
Ford Ranger 1993-On

UNIT PACKAGE: 25



21304

(Ford: 3M8Z-16K262-A;
Mazda: GJ6A-50-ES1)
Black Nylon

Rear Bumper Grommet with Sealer

Head Size: 27mm x 30mm
Stem Length: 32mm
Fits into 17mm x 20mm Hole
Ford Fusion, Milan, MKS, MKZ
& Zephyr and Mazda 6 2003 - On

UNIT PACKAGE: 5



20530

(Not Available from O.E.M.)
Black Nylon

**Radiator Shroud
Air Deflector Retainer**
Head Diameter: 20mm
Stem Diameter: 13mm
Stem Length: 16mm
Ford Expedition 2003 - On

UNIT PACKAGE: 50



17195

(Isuzu: 8942180270)
Black Nylon

Grille Clip

Width: 13mm
Length: 22mm
Ford Escort, Honda, Isuzu,
Mitsubishi & Plymouth Laser

UNIT PACKAGE: 25



23818

(90467-12020, H200-S0-715
BF67-S0715)
Gray Nylon

Grille & Headlamp Door Clip

Toyota Corolla 1983 - On
Chevrolet Nova 1986 - On
Mazda 323 1986 - On
Ford Festiva & Tracer 1988 - On

UNIT PACKAGE: 25



20171

(N807189-S100, N811353-S100)
White Nylon

Cowl Vent Grommet
Screw Size: M4.2 (#8)
Fits into 10mm x 14mm Hole
F150 Pickup, Expedition
& Windstar 1995 - On

UNIT PACKAGE: 10



23955

(Not Available from OEM)
Nylon

Cowl Vent Retainer
Ford Focus 2000 - 2003

UNIT PACKAGE: 25



19238

(F6DZ-5402316-AA)
Natural Nylon

Cowl Top Vent Grille Grommet

Use with Auveco 19237
Ford Taurus & Sable 1996-On

UNIT PACKAGE: 50



19237

(W701649-S, W704881-S300)
Black Nylon

#10 x 1-1/32"

Cowl Top Vent Grille Nylon Screw

Head Outer Diameter: 9/16"
Use with Auveco 19238
Ford Taurus & Sable 1996-On

UNIT PACKAGE: 50



18816
(N807994-S)
Black Nylon

Grille & Side Marker Light Grommet
Fits into 10mm Hole
Ford 1994-On

UNIT PACKAGE: 50



23871
(W700158-S300)
White Nylon

Door Trim Grommet
Screw Size: 4.2mm
Hole Size: M12
Washer Diameter: 22mm
Ford Contour &
Mercury Mystique 1995 - On

UNIT PACKAGE: 25



19526
(N807247-S)
Natural Nylon

**Rear Door & Back Window
Trim Panel Grommet**
Screw Size: #12 - 24
Fits into 1/2" Hole
Lincoln Town Car 1990 - On

UNIT PACKAGE: 25



19783
(N811169S, W705550-S300)
White Nylon

Park & Turn Signal Housing Grommet
Stud Size: 7/32"
Head Diameter: 13mm
Stem Length: 9mm
Fits into 11mm Hole
F250 - F550 Trucks 1999 - On

UNIT PACKAGE: 50



22359
(W702438-S300)
Black Nylon

Radiator Grille Screw Grommet
Screw Size: M4.8 (#10)
Head Diameter: 20mm
Stem Length: 11mm
Fits into 11.5mm x 7.5mm Slot
Ford C-Max, Escape, Fiesta, Focus, Fusion,
Transit Connect and Lincoln
MKC & MKZ 2015 - 2010

UNIT PACKAGE: 25



23870
(W700505-S300, W702438-S300)
Nylon

**Cowl, Trim, Bumper, Fender,
Engine Under Cover Grommet**
Screw Size: 4.8mm
Head Diameter: 20mm
Fits into 11.5mm x 8.2mm Hole
Ford Contour &
Mercury Mystique 1995 - On
Fiesta, Focus C-Max, Escape 2011 - On

UNIT PACKAGE: 25



19752
(Not Available from O.E.M.)
White Nylon

Door Belt Moulding Clip
Taurus, Sable Contour &
Mystique 1998 - 95

UNIT PACKAGE: 15



23718
(EIDZ-16C072A)

**Front Fender Side Lower Rear
Moulding Clip**
Size: 1" x 4-1/2"
Ford 1981 - On

UNIT PACKAGE: 25



23640
(D5VZ-6021066A)
Natural Nylon
Body Side Moulding Clip
Size: 1-3/8" x 1"
Ford 1975 - 1976
UNIT PACKAGE: 50



20400
(YF4Z-8194-AA)
Nylon
Radiator Grille Clip
Width: 11/32"
Length: 1-9/32"
Mercury Sable 2000 - On
UNIT PACKAGE: 15



23708
(D9ZZ-6621060-A)
Belt Moulding Retainer
Mustang 1979 - On
UNIT PACKAGE: 50

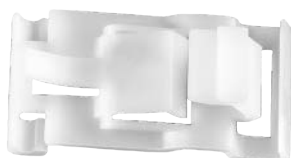

21306
(Not Available from O.E.M.)
White Nylon
Belt Moulding Clip
Width: 18mm
Length: 37mm
Taurus 2010 - On
UNIT PACKAGE: 10



21507
(Not Available from O.E.M.)
White Nylon
Belt Moulding Clip
Width: 25mm
Length: 36mm
Overall Height: 27mm
Edge 2009 - On
UNIT PACKAGE: 15



18377
(W701430-S300)
Black Nylon
Door Trim Retaining Clip
Contour & Mystique 1995-On
UNIT PACKAGE: 10



21790
(W709688-S300)
Black Nylon
Hood Insulation Retainer
Head Size: 28mm x 30mm
Stem Length: 14mm
Overall Height: 16mm
Ford Focus & Lincoln MKZ 2012 - On
UNIT PACKAGE: 25



22431
(Ford: W716783-S300)
Black Nylon
Hood Insulation Retainer
Head Size: 25mm x 30mm
Stem Length: 15mm
Overall Height: 17mm
Ford C-Max & Escape 2013 - On
Lincoln MKC 2016 - On
UNIT PACKAGE: 25



25189
(Ford: W716569-S300)
Natural Nylon
Wheel & Body Side Moulding Clip
Width: 12mm
Length: 24.5mm
Overall Height: 12.75mm
Screw Size: M5
Ford Transit 150, 250, 350 2015 - On
UNIT PACKAGE: 25



20862
(4L3Z-1510182-AA)
Black Nylon
Roof Garnish Moulding Clip
Tip to Tip: 42mm
Front to Back: 12mm
Height: 21mm
Ford F-150 2005 - On
UNIT PACKAGE: 15



22912
(Ford: FL3Z-13489-A)
Black Nylon
Tail Lamp Assembly Clip
Width: 27mm
Length: 25mm
Ford F-150 2017 - On
UNIT PACKAGE: 25



23932
(Not Available from OEM)
Nylon
Fender Lip Moulding Retainer
Head Size: 12 x 20mm
Fits in 10mm Hole
Ford Expedition & Navigator 1998 - On
UNIT PACKAGE: 25



21506
(Not Available from O.E.M.)
Black & White Nylon
Windshield Moulding Clip with Sealer
Top Head Size: 13mm x 13.5mm
Bottom Head Size: 12mm x 14mm
Stem Length: 9mm
Explorer 2011 - On
UNIT PACKAGE: 10



22038

(W716460-S300)
White Nylon

Moulding Clip

Head Size: 11mm x 20mm

Stem length: 11mm

Overall Height: 13.5mm

Ford Fiesta, Fusion & Mustang and Lincoln
MKZ 2010 - On

UNIT PACKAGE: 25



21202

(W790173-S900)
Blue Nylon

Windshield Moulding Clip with Sealer

Top Head Size: 14mm x 18mm

Bottom Head Size: 19mm x 18mm

Stem Length: 10mm

Fits into 9mm Hole

Flex 2009 - On

UNIT PACKAGE: 10



25290

(Ford: W790383-S900)
Yellow Nylon

Wheel Opening Moulding Clip

Top Head Size: 14mm x 20mm

Bottom Head Size: 14mm x 18mm

Stem Length: 18mm

Overall Height: 28mm

Fits into 10mm Hole

Ford F-150 2020 - 2015

UNIT PACKAGE: 25



20817

(W710528-S300)
White Nylon

Moulding Clip with Sealer

Top Head Size: 14mm x 20mm

Bottom Head Size: 15mm x 20mm

Stem Length: 12mm

Fits into 9mm Hole

Lincoln Navigator 2003 - On

UNIT PACKAGE: 15



25354

(Ford: W719209-S300)
White Nylon

"B" Pillar Moulding Clip with Sealer

Top Head Size: 12mm x 14mm

Bottom Head Size: 12mm x 14mm

Stem Size: 5.75mm x 9mm

Stem Length: 11mm

Overall Height: 17mm

Fits into 6mm x 10mm Slot

Ford Bronco Sport 2021 - On;

Escape 2020 - On; Lincoln

Continental 2020 - 2017,

Corsair 2020-On

UNIT PACKAGE: 15



21198

(Not Available from O.E.M.)
White Nylon

Door Cladding Moulding Clip with Sealer

Top Head Size: 15mm x 20mm

Bottom Head Size: 20mm x 24mm

Stem Length: 11mm

Fits into 9mm Hole

Edge and Lincoln MKX 2007 - On

UNIT PACKAGE: 10



22124

(W716352-S300)
White Nylon

Rocker Panel & Door Moulding Clip with Sealer

Top Head Size: 12mm x 20mm

Bottom Head Size: 12mm x 20mm

Stem Length: 14mm

Fits into 9mm Hole

Ford Edge, Mustang &
Mustang G.T. 2015 - On

UNIT PACKAGE: 25



20979

(6G1Z-5410182-C)
Blue Nylon

Wheel Flare & Rocker Panel Moulding Clip

Top Head Size: 14mm x 18mm

Bottom Head Size 14mm x 18mm

Stem Length: 11mm

Fits into 9mm Hole

Ford 500 2005 - On

UNIT PACKAGE: 25



22930

Not Available from O.E.M.
Blue Nylon

Lower Cab Moulding Clip with Sealer

Top Head Size: 9.5mm x 20mm

Bottom Head Size: 14mm x 20mm

Stem Length: 21.9mm

Overall Height: 27mm

Fits into 9mm Hole

Ford F-150 & F-250 2015 - On

UNIT PACKAGE: 10



21669

(Ford: W716497-S300)
Gray Nylon

Bumper Moulding Clip with Sealer

Top Head Size: 12mm x 20mm

Bottom Head Size: 12mm x 24mm

Stem Length: 16mm

Ford Escape 2013 - On, Mustang 2018,
Bronco 2021 - On, Lincoln MKC 2019 - 2015

UNIT PACKAGE: 10



21668
(W715201-S300)
White Nylon

Rocker Panel Moulding Clip with Sealer
Top Head Size: 12mm x 20mm
Bottom Head Size: 15mm x 20mm
Stem Length: 15mm
Escape 2013 - On

UNIT PACKAGE: 15



22099
(W716351-S300)
White Nylon

Wheel Opening & Rocker Moulding Clip
Top Head Size: 12mm x 20mm
Bottom Head Size: 12mm x 20mm
Stem Length: 14mm
Fits into 9mm Hole
Ford Escape & Lincoln MKC 2013 - On

UNIT PACKAGE: 25



22033
(W716503-S300)
White Nylon

Rocker Panel & Deck Lid Moulding Clip with Sealer
Top Head Size: 15mm x 20mm
Bottom Head Size: 20mm x 20mm
Stem Length: 14mm
Fits into 9mm Hole
Ford Fusion & MKZ 2013 - On

UNIT PACKAGE: 25



21174
(W713590-S300)
White Nylon

Windshield Moulding Clip with Sealer
Top Head Size: 14mm x 18mm
Bottom Head Size: 15mm x 18mm
Stem Length: 11mm
Fits into 9mm Hole
Flex 2009 - On

UNIT PACKAGE: 15



21522
(Not Available from O.E.M.)
Gray Nylon

Fender & Rocker Moulding Clip with Sealer
Top Head Size: 14mm x 18mm
Bottom Head Size: 18mm x 21mm
Stem Length: 15mm
Fits into 9mm Hole
Explorer 2011 - On

UNIT PACKAGE: 25



21523
(Not Available from O.E.M.)
White Nylon

Rocker Moulding Clip with Sealer
Top Head Size: 14mm x 18mm
Bottom Head Size: 14mm x 18mm
Stem Length: 15mm
Fits into 9mm Hole
Lincoln MKS 2010 - On

UNIT PACKAGE: 10



20981
(Not Available from O.E.M.)
White Nylon

Wheel Flare Moulding Clip with Sealer
Top Head Size: 14mm x 29mm
Bottom Head Size: 14mm x 29mm
Stem Length: 16mm
Fits into 9mm Hole
Explorer 2006 - On

UNIT PACKAGE: 15



20968
(Not Available from O.E.M.)
Yellow Nylon

Wheel Lip Moulding Clip
Head Size: 15mm x 51mm
Stem Length: 11mm
Fits into 10mm Hole
Expedition & Navigator 1998 - On

UNIT PACKAGE: 15



21230
(Ford: W718240-S300)
White Nylon

Fender Flare Moulding Clip
Top Head Size: 14mm x 34mm
Bottom Head Size: 14mm x 33mm
Stem Length: 14mm
Fits into 9mm Hole
Ford Explorer 2007 - On; F250, F350, F450, F550 2017 - On

UNIT PACKAGE: 25



21148
(Not Available from O.E.M.)
White Nylon

Drip Rail Moulding Clip with Sealer
Width: 1-11/32"
Overall Height: 11/16"
500, Montego, Sable & Taurus 2005 - On

UNIT PACKAGE: 15



21000
(F57B-16241-AA)
White Nylon

Fender Moulding Clip
Head Size: 15mm x 51mm
Stem Length: 11mm
Fits into 8mm Hole
Explorer & Others 2005 - On

UNIT PACKAGE: 15



20965
(F4ZZ-6310182-A)
Black Nylon

Rocker Panel and Ground Effects Moulding Clip
Head Size: 16mm x 50mm
Stem Length: 14mm
Fits into 9mm Hole
Mustang 1995 - On

UNIT PACKAGE: 15



20358
(F6DZ-5410182-AA)
Black Nylon

Rocker Panel Moulding Clip
Head Size: 13mm x 39mm
Stem Length: 14mm
Fits into 9mm Hole
Sable, Taurus & Lincoln LS2000
1996 - On

UNIT PACKAGE: 10



21319
(Not Available from O.E.M.)
White Nylon

Ground Effect Moulding Clip
Head Size: 20mm x 40mm
Stem Length: 14mm
Overall Height: 30mm
Fits into 9mm Hole
Ford 2008 - On

UNIT PACKAGE: 10



20663
(F57Z-16241-AB,
W709767-S300)
Black Nylon

Rocker Panel Moulding Clip
Head Size: 14mm x 40mm
Stem Length: 11mm
Ford Mustang 2001 - On

UNIT PACKAGE: 15

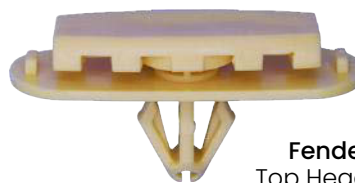

21219
(Not Available from O.E.M.)
Yellow Nylon

Fender Flare Moulding Clip
Top Head Size: 14.5mm x 33.5mm
Bottom Head Size: 15mm x 45mm
Stem Length: 14mm
Fits into 11mm Hole
F-450 & F-550 Truck 2009 - On

UNIT PACKAGE: 10



19441
(FITZ-7810182-A)
Black Nylon

Rocker Panel and Ground Effects Moulding Clip
Explorer, Expedition & F150
1991-On

UNIT PACKAGE: 25



23659
(D7LZ-6540368-A)

Lower Back Panel Moulding Retainer
Ford 1977 - On

UNIT PACKAGE: 50



25289
(Ford: W716878-S300)
Black Nylon

Rocker Panel Moulding Clip
Head Size: 15mm x 50mm
Stem Length: 11mm
Fits into 9mm Hole
Ford F-150 2020 - 2015, F-250 & F-350 2017 - On

UNIT PACKAGE: 25



20977
(Ford: 6G1Z-5410182-A,
W716350-S300)
Gray Nylon

Rocker Panel Moulding Clip
Top Head Size: 22mm x 30mm
Overall Height: 18mm
Ford Five Hundred, Freestyle 2005 - 2007;
Fusion 2013 - On; Taurus 2009 - 2008;
Lincoln MKZ 2019 - 2013;
Mercury Montego 2007 - 2005;
Sable 2009 - 2008

UNIT PACKAGE: 15



25090

(Ford: W718456-S300)
Black Nylon

Rocker Panel Moulding Clip

Top Head Size: 22mm x 30mm
Overall Height: 18mm
Ford Escape 2020 - On, Explorer
2010 - On; Lincoln Aviator
2020 - On, Continental 2019 - 2017
UNIT PACKAGE: 15



25113

(Ford: BK3Z-00817-AA)
White Nylon

Rocker Moulding Clip

Width: 19.5mm
Length: 29mm
Stem Diameter: 8.3mm
Stem Length: 10mm
Fits into 8.5mm Hole
Ford Transit 150, 250, 350 2014 - On
UNIT PACKAGE: 15



20392

(Not Supplied by O.E.M.)
White Nylon

Moulding Clip

Head Diameter: 3/4"
Stem Length: 15/32"
Fits into 5/16" Hole
Ford Expedition, Explorer &
Mountaineer 2001 - On

UNIT PACKAGE: 10



20355

(W705849-S300)
Nylon

Front End Moulding Clip

Top Head Size: 1/2" x 13/16"
Bottom Head Size: 11/16" x 25/32"
Stem Length: 3/8"
Ford 2000 - On
UNIT PACKAGE: 10



18882

(Ford: KA80-51-PR6;
Mazda: EA01-50-048)
Black Nylon

**Body Side Lower
Wide Moulding Grommet**

Ford Probe & Mazda MX6 1993-On
UNIT PACKAGE: 10



19413

(F7UZ-15238A32)
Black Nylon

Door Panel Screw Cover

Head Diameter: 3/4" (19mm)
Fits into 5/8" (16mm) Hole
Ford Econoline E150 1997 - On
UNIT PACKAGE: 25



23898

(FICZ-5802316-C)
Nylon

Cowl Screw Cover
Ford Escort 1991 - On

UNIT PACKAGE: 15



22535

(Chrysler: 6510123AA)
Black Nylon

**Rocker Panel &
Splash Shield Screw Grommet
with Specialty Screw**

Grommet Head Diameter: 18mm
Length Under Head: 36mm
Black Hex Washer Head Sems® Screw
Assembled in Grommet
Chrysler Pacifica, Dodge Challenger &
Ram and Jeep Cherokee 2011 - On

UNIT PACKAGE: 5



14953

(Ford: N803494S; GM: 15679091)
Black Nylon

Fascia, Trim & Grille Retainer

Head Size: 15/32" x 15/32"
Stem Length: 21/32"
Fits into 1/4" Square Hole or Slot
Aerostar, Escort & Lynx 1985-On
GM 1994 - On

UNIT PACKAGE: 25



17060

(Ford: E92Z-17C756C;
Mazda: GJ21-50-034)
Black Nylon

Bumper Cover Retainer

Head Size: 20mm x 30mm
Stem Length: 20mm
Fits into 10mm Hole
Ford Probe & Mazda MX6 1989-On

UNIT PACKAGE: 10



20923

(Ford: 3M8Z-1502316-A;
Mazda: GJ6E-50-715A)
Black Nylon

Cowl Vent

Push-Type Retainer

Head Size: 8.5mm x 12mm
Stem Length: 9mm
Fits into 5mm Hole
Fusion, Milan & Zephyr 2006 - On
Mazda 5 & 6 2003 - On

UNIT PACKAGE: 15



14988
(N805229S)
Black Nylon

Push-Type Retainer
Head Diameter: 7/16"
Stem Length: 11/16"
Fits into 15/64" Hole
Ford 1987 - On
UNIT PACKAGE: 25



14995
(GM: 10195515;
Ford: N805026S;
Chry: 4696488, 6503163)
Black Nylon

Push-Type Retainer
Head Diameter: 1/2"
Stem Length: 1-13/64"
Fits into 9/32" Hole
GM, Ford &
Chrysler 1987 - On

UNIT PACKAGE: 25



21172
(W713202-S300,
W713445-S300)
Black Nylon

Bumper Push-Type Retainer
Head Diameter: 13mm
Stem Length: 18mm
Fits into 8mm Hole
Fusion 2006 - On

UNIT PACKAGE: 15



22058
(N807673-S)
Black Nylon

Tailgate Push-Type Retainer
Head Diameter: 14mm
Stem Length: 9mm
Fits into 7mm Hole
Ford Explorer Sport Trac 2010 - 2007

UNIT PACKAGE: 10



23822
(B040-68-865-A96, 94530438)
Nylon

Interior Trim, Cowl, Fender & Bumper Push-Type Retainer
Head Diameter: 15mm
Stem Length: 14mm
Fits in 6mm Hole
Ford Probe 1988
Mazda M6 1988 - On
Chevrolet Aveo 2004 - On

UNIT PACKAGE: 25



14992
(Ford: N803946S;
Chry: 6502871;
Mercedes: 000-991-52-40)
Black Nylon

Door Panel Push-Type Retainer
Head Diameter: 19/32"
Stem Length: 29/32"
Fits into 1/4" Hole
Ford & Chrysler 1987 - On;
Mercedes Metris 2020 - 2016; Sprinter
1500, 2500, 3500 2019 - On

UNIT PACKAGE: 50



20191
(YS4Z-16K262-AA)
Black Nylon

Push-Type Retainer
Head Diameter: 16mm
Stem Length: 18mm
Fits into 6mm Hole
Focus 2000 - On

UNIT PACKAGE: 25



18893
(N806322-S)
Black Nylon

Trim Panel Push-Type Retainer
Head Diameter: 11/16"
Stem Length: 1/2"
Fits into 1/4" Hole

UNIT PACKAGE: 15



14991
(GM: 10139822; 25680782;
Ford: N808147S)
Black Nylon

Push-Type Retainer
Head Diameter: 11/16"
Stem Length: 11/16"
Fits into 1/4" Hole
GM & Ford 1987 - On

UNIT PACKAGE: 25



18894
(N807578-S, N808332-S)
Black Nylon

Trim Panel Push-Type Retainer
Head Diameter: 11/16"
Stem Length: 3/4"
Fits into 1/4" Hole

UNIT PACKAGE: 15



14753

(GM: 20664092;
Ford: N804570S; Chry: 4638136)
Black Nylon

Trim Retainer

Head Diameter: 11/16"
Stem Length: 7/8"
Fits into 1/4" Hole
Ford 1986-On
Chrysler 1998 - On

UNIT PACKAGE: 25



21098

(Ford: W706092-S300;
Chrysler: 6508197-AA)
Black Nylon

Front Air Shield, Splash Guard & Heat Shield Push-Type Retainer

Head Diameter: 18mm
Stem Length: 18mm
Fits into 6.4mm Hole
Ford Taurus 2008 - On
Dodge Ram 2006 - On

UNIT PACKAGE: 25



18895

(N807577-S, N808331-S)
Black Nylon

Trim Panel Push-Type Retainer

Head Diameter: 11/16"
Stem Length: 1-3/32"
Fits into 1/4" Hole
Aerostar & Windstar

UNIT PACKAGE: 15



20367

(W706713-S300)
Black Nylon

Bumper Cover Push-Type Retainer

Head Diameter: 18mm
Stem Length: 18mm
Fits into 8mm Hole
Ford Escape 2001- On

UNIT PACKAGE: 25



21703

(W716510-S300)
Black Nylon

Lower Radiator Shield Push-Type Retainer

Head Diameter: 18mm
Stem Length: 12mm
Fits into 7mm Hole
Ford Fusion 2013 - On

UNIT PACKAGE: 10



21089

(W710250-S300)
Black Nylon

Rear Bumper Push-Type Retainer

Head Diameter: 18mm
Stem Length: 18mm
Fits into 8mm Hole
Edge 2007 - On

UNIT PACKAGE: 25



17632

(Mazda: B092-51-833;
Ford: MB-455-56143, W705845-S300;
Hyundai: 86590-28000)
Black Nylon

Push-Type Retainer

Head Diameter: 18mm
Stem Length: 12mm
Fits into 8mm Hole
Mazda & Ford Aspire

UNIT PACKAGE: 10



19849

(Not Available from O.E.M.)
Black Nylon & Santoprene Rubber

Bumper Push-Type Retainer

Head Diameter: 18mm
Stem Length: 18mm
Fits into 8mm Hole
Taurus & Sable 2000 - On

UNIT PACKAGE: 25



20545

(N811283-S)

Black Nylon & Santoprene Rubber

Trim Panel Push-Type Retainer

Head Diameter: 18mm
Stem Length: 18mm
Fits into 6.3mm Hole
Ford Expedition & Navigator 1997 - On

UNIT PACKAGE: 2



16858

(Nissan: 63844-01A00;
Ford: MNA01-56145, NA01-56145;
Kia: MNA01-56-145;
Mazda: NA01-56-145)
Black Nylon

Push-Type Retainer

Head Diameter: 20mm
Stem Length: 18mm
Fits into 8mm Hole
Nissan 1980-On
Probe & Aspire 1995-On
Kia & Mazda

UNIT PACKAGE: 25



14994
(N804837S)
Black Nylon

Push-Type Retainer
Head Diameter: 1"
Stem Length: 29/32"
Fits into 1/4" Hole
Ford 1987 - On

UNIT PACKAGE: 50



20233
(W705956-S300)
Black Nylon

Cowl Push-Type Retainer
Head Diameter: 25mm
Shoulder Diameter: 10mm
Shoulder Length: 3mm
Stem Length: 12mm
Fits into 9mm Hole
Lincoln LS 1999 - On

UNIT PACKAGE: 15



11705
(387843-S)
Black Nylon

Fender Shield Retainer
Head Diameter: 19/32"
Stem Length: 5/8"
Fits into 1/4" Hole
Ford 1978-On

UNIT PACKAGE: 50



15522
(N805231S)
Black Nylon

Push-Type Retainer
Head Diameter: 5/8"
Stem Length: 17/32"
Fits into 1/4" Hole
Taurus, Topaz & Sable 1989-On

UNIT PACKAGE: 50



20310
(383142-S)
Black Nylon

Grille to Headlight Bracket Push-Type Retainer
Head Diameter: 5/8"
Stem Length: 7/16"
Fits into 1/4" Hole
Replaces Auveco 10214
Ford

UNIT PACKAGE: 50



19607
(XL3Z-17E971-AA)
Natural Nylon

Front Bumper Cover Push-Type Retainer
Head Diameter: 16mm
Stem Length: 12mm
Fits into 10mm Hole
F150 & F250 Trucks 1999-On

UNIT PACKAGE: 25



20273
(Ford: N808791;
Chry: 5GC71RC3AA, 5GF92RC3AA)
Gray Nylon

Interior Trim, Dash & Console Push-Type Retainer
Head Diameter: 19mm
Shoulder Diameter: 10mm
Shoulder Length: 7mm
Stem Length: 22mm
Fits into 9mm Hole
Dodge Durango &
Ford Pick-Ups 1997 - On

UNIT PACKAGE: 25



20516
(W706182-S300)
Black Nylon

Headlight Mounting & Deck Lid Push-Type Retainer
Head Diameter: 20mm
Hex: 10mm
Stem Length: 13mm
Fits into 8mm Hole
Ford Expedition, Explorer & Focus 2000 - On

UNIT PACKAGE: 25



11706
(387944-S)
Black Nylon

Grille to Metal Stamping Retainer
Head Diameter: 3/4"
Shoulder Length: 1/4"
Stem Length: 11/16"
Fits into 1/4" Wide Slot
Ford Truck 1978-On

UNIT PACKAGE: 50



19638
(Chry: 4805405AA;
Ford: 1L5Z-17K826AA)
Black & White Nylon

Push-Type Retainer
Head Diameter: 34mm
Stem Length: 20mm
Fits into 8mm Hole
Chrysler 1998-On
Ford Trucks 2005 - On

UNIT PACKAGE: 15



17478
(Mazda: B101-68-252-00)
Black Nylon

Interior Trim Push-Type Retainer
Head Diameter: 14mm
Stem Length: 16mm
Fits into 6mm Hole
Ford Probe and Mazda MX6 1988-On

UNIT PACKAGE: 25



25178
(Ford: W703243-S300)
Black Nylon

Cowl Vent Push-Type Retainer
Head Diameter: 14mm
Stem Diameter: 6.3mm
Stem Length: 18mm
Fit into 6.3mm Hole

Ford Transit Connect 150, 250, 350 2015 - On

UNIT PACKAGE: 10



22349
(W719367-S300)
Black Nylon

Push-Type Retainer
Head Diameter: 14mm
Stem Length: 18mm
Fits into 8mm x 11mm Hole
Ford

UNIT PACKAGE: 15



19801
(GM: 21077123; Chry: 6509103AA,
Ford: W705436-S300)
Black Nylon

Wheel Opening Moulding Push-Type Retainer
Head Diameter: 19/32" (15mm)
Stem Length: 3/4" (19mm)
Fits into 1/4" (6mm) Hole
Saturn 1991 - On
Ford 2002 - On
Chrysler 2010 - On

UNIT PACKAGE: 25



17222
(Ford: F3LY-14570-B; GM: 21075686)
Black Nylon

Push-Type Retainer
Head Diameter: 15mm
Stem Length: 20mm
Fits into 8mm Hole
Rocker Panel, Wheel Liner &
Air Inlet Duct Applications
Ford
GM Saturn 1991 - On

UNIT PACKAGE: 25

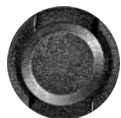

17103
(GM: 15681408; Ford: N803709S)
Black Nylon

Fascia Attachment Push-Type Retainer
Head Diameter: 15mm
Stem Length: 23mm
Fits into 6mm Hole
GM & Ford 1986-On

UNIT PACKAGE: 50



19639
(GM: 15149708; Chry: 6506008AA; Ford:
W709176-S300)
Black Nylon

Radiator, Wheelhouse, Fender & Front Bumper Cover, Grille, Rocker Push-Type Retainer
Head Diameter: 17mm
Stem Length: 16mm
Fits into 6mm Hole
GM C & K Trucks 1999 - On;
Jeep Liberty 2002 - On;
Ford Explorer 2010 - 2007,
F150 2009 - On, Mustang 2014 - 2005,
Transit 2015 - On

UNIT PACKAGE: 25



13993
(Ford: N803362-S; GM: 20510029,
Chry: 34202672)
Black Nylon

Body Retainer
Head Diameter: 1 1/16"
Stem Length: 7/8"
Fits into 1/4" Hole

Ford, GM & Chrysler 1984 - On

UNIT PACKAGE: 25



21024
(Ford: 5R3Z-54310D12-AAA,
6E5Z-7850980-AAA;
Mazda: GJ21-68-885B-02)
Black Nylon

Trim Panel Push-Type Retainer
Head Diameter: 18mm
Stem Length: 10mm
Fits into 6mm Hole
Fusion & Mustang 2005 - On
Mazda 1992 - On

UNIT PACKAGE: 15



18206
(GJ21-68885-B69)
Gray Nylon

Push-Type Retainer
Head Diameter: 18mm
Stem Length: 12mm
Fits into 6mm Hole
Probe & Mazda MX6 1989-On

UNIT PACKAGE: 25



16726
 (N808048S, W705532-S300)
 Black Nylon
**Front Bumper Stone
 Deflector Retainer**
 Head Diameter: 18mm
 Stem Length: 18mm
 Fits into 6.3mm (1/4") Square Hole
 Bronco, Ranger & Explorer 1989-On
UNIT PACKAGE: 25



22227
 (W718088-S300)
 Black Nylon
**Fender Apron
 Push-Type Retainer**
 Head Diameter: 18mm
 Stem Length: 20mm
 Fits into 7mm Hole
 Ford Fusion 2015 - On
UNIT PACKAGE: 25



20989
 (GM: 11589291; Ford: W713331-S300)
 Black Nylon
Air Dam & Grille Push-Type Retainer
 Head Diameter: 18mm
 Stem Length: 22mm
 Panel Range: 7.0mm - 9.5mm
 Fits into 6.5mm Hole
 GM 2003 - On
 Ford
UNIT PACKAGE: 25



14018
 (N803716-S)
 Black Nylon
Fascia Retainer
 Head Diameter: 18mm
 Stem Length: 23mm
 Fits into 7mm Hole
 Mustang/Capri 1985-On
UNIT PACKAGE: 25



17216
 (GM: 21030249; Ford: N807389S,
 W711035-S300; Chry: 6503598)
 Black Nylon
**Air Baffle to Under Carriage
 Push-Type Retainer**
 Head Diameter: 20mm
 Stem Length: 20mm
 Fits into 8mm Hole
 GM Saturn 2 Door & 4 Door Models 1991 - On;
 Ford EcoSport 2018 - On; Escape, F-250, 350,
 450, 550 2019 - 2017; Expedition 2018;
 Explorer 2006 - On; Fiesta 2019 - 2011;
 Fusion 2013 - On; Mustang 2018 -2015;
 Transit 2015 - On; Bronco 2021 - On;
 Lincoln MKC 2019 - 2015; MKZ 2019 - 2013;
 Mariner 2011 - 2007; Mountaineer 2010 - 2006,
 Navigator 2019 - 2015 & Chrysler
UNIT PACKAGE: 25



20889
 (GM: 11589293; Ford: W712196-S300)
 Black Nylon
**Cowl Vent & Fender
 Push-Type Retainer**
 Head Diameter: 20mm
 Stem Length: 22mm
 Panel Range: 4.5mm - 7.0mm
 Fits into 8.5mm Hole
 Buick Century, LaCrosse & Regal, Cadillac, Chevrolet
 Equinox, GM Trucks, Hummer H3 and Pontiac Grand Prix
 & Torrent 1997 - On; Ford Edge 2007 - On;
 Explorer 2020 - On; Fusion 2006 - On; F-150 2019 - 2016;
 F-250, F-350 2018 - 2017; Fiesta 2019 - 2011;
 Flex 2019 - 2009; Bronco 2021 - On;
 Lincoln Aviator 2020 - On; Nautilus 2019 - On;
 Continental 2019 - 2017; MKC 2019 - 2015;
 MKT 2019 - 2010; MKX 2019 - 2007; Milan 2011 - 2006

UNIT PACKAGE: 25



20632
 (GM: 11518017; Ford: W708530-S300)
 Black Nylon
**Bumper Cover & Fender Shield
 Push-Type Retainer**
 Head Diameter: 20mm
 Stem Length: 26mm
 Fits into 8mm Hole
 GM & Ford 1997 - On
UNIT PACKAGE: 15



22532
 (Ford: W717823-S300)
 Black Nylon
**Splash & Heat Shield
 Push-Type Retainer**
 Head Diameter: 25mm
 Stem Length: 11mm
 Fits into 6.5mm Hole
 Ford Mustang 2014 - On

UNIT PACKAGE: 15



20993
 (GM: 11589295;
 Ford: W712665-S300)
 Black Nylon
**Fender, Flare, Gas Tank & Panel
 Attachment Push-Type Retainer**
 Head Diameter: 25mm
 Stem Length: 20mm
 Panel Range: 3.0mm - 6.0mm
 Fits into 10.5mm Hole
 GM 2005 - On
 Ford
UNIT PACKAGE: 25



22284
(W718365-S300)
Black Nylon

**Front Fender, Cowl Grille,
Rocker & Mudguard
Push-Type Retainer**
Head Diameter: 25mm
Stem Length: 24mm
Fits into 8.5mm Hole
Ford Mustang & Transit
Connect and
Lincoln MKC 2014 - On

UNIT PACKAGE: 10



15701
(N804674-S)
Black Nylon

Push-Type Retainer
Head Diameter: 25mm
Stem Length: 27mm
Fits into 7mm Hole
Mustang & Capri

UNIT PACKAGE: 50



19244
(N808847-S)
Black Nylon

**Trunk Trim Panel Push-Type
Retainer**
Head Diameter: 1"
Stem Length: 11/16"
Fits into 1/4" Square Hole
Taurus & Sable 1996-On

UNIT PACKAGE: 25



14020
(Ford: N802781-S; GM: 14093088)
Black Nylon

**Splash Shield &
Fascia Retainer**
Head Diameter: 1"
Stem Length: 7/8"
Fits into 1/4" Hole

UNIT PACKAGE: 25



14019
(Ford: N803421-S, Chry: 6501590)
Black Nylon

Splash Shield & Fascia Retainer
Head Diameter: 1"
Shoulder Length: 1/8"
Stem Length: 7/8"
Fits into 5/16" Hole

UNIT PACKAGE: 25



13994
(GM: 20570245; Ford: N804614S)
Black Nylon

Spare Tire Retainer
Head Diameter: 1"
Stem Length: 7/8"
Fits into 5/16" Hole
UNIT PACKAGE: 25



18503
(W701054-S300)
Black Nylon

Front Bumper Push-Type Retainer
Head Diameter: 1"
Stem Length: 1"
Fits into 5/16" Hole
Contour & Mystique 1995-On
UNIT PACKAGE: 25



19337
(N808908-S)
Black Nylon

**Headlight Accessory
Push-Type Retainer**
Head Diameter: 14mm
Stem Length: 23mm
Fits into 6.3mm (1/4") Hole
Mustang 1996 - On
UNIT PACKAGE: 10



20169
(W701971-S)
White Nylon

Door Trim Panel Push-Type Retainer
Head Diameter: 15mm
Stem Length: 13mm
Fits into 7mm Hole
Lincoln LS 2000 - On
UNIT PACKAGE: 25



20363
(Not Available from O.E.M.)
White Nylon

Door Trim Panel Push-Type Retainer
Top Head Diameter: 15mm
Bottom Head Diameter: 20mm
Overall Length: 32mm
Fits into 9mm Hole
Ford 2001 - On
UNIT PACKAGE: 25



19511
(W704958-S300)
White Nylon

**Rear Door Lower Trim Panel
Push-Type Retainer**
Round Head Diameter: 19/32"
Wedge Shaped Head Diameter: 29/32"
Stem Length: 11/16"
Fits into 3/8" Hole
Lincoln Town Car 1998 - On
UNIT PACKAGE: 25



20970

(Not Available from O.E.M.)
Black Nylon

M14 x 34mm
Bumper and Door Insulator
Nylon Screw
Head Outer Diameter: 22mm
No. 3 Square Drive
Fits into 12mm Hole
GM, Ford & Chrysler 2005 - On

UNIT PACKAGE: 25



19472

(GM: 25535963; Ford: N811772S)
Nylon

Upper Deflector Shield

UNIT PACKAGE: 25



22940

(Ford: BB5Z-00817-A)
Silver Finish

Engine Cover Twist-to-Turn Retainer Pin

Flange Diameter: 1 1/16"
Stem Length: 3/4"
Use with Auveco 25001
Ford Edge & F-150 2014 - 2011
Explorer 2011 - On
Police Interceptor 2019 - 2016
Lincoln Mark LT & MKX 2015 - 2011

UNIT PACKAGE: 15



25001

(Ford: W716006-S439)
Zinc Finish

Under Cover Retainer Nut

Overall Height: 16mm
Use with Auveco 22940
Ford Edge & F-150 2014 - 2011
Explorer 2011 - On; Flex & Taurus 2013 - On
Lincoln Mark LT 2014 - 2011; MKS & MKX 2016 - 2012;
MKT 2013 - On

UNIT PACKAGE: 25



14217

(GM: 1257702, 20346654;
Ford: 383207-S
AMC: 3693099)
Nylon

Routing Clip

UNIT PACKAGE: 25



17164

(E0VY-13A506-A)
Nylon

Rear Light Wiring Retainer

Width: 3/8"
Length: 1-7/16"
Stem: 9/32" x 7/16"
Ford 1979-On

UNIT PACKAGE: 50



20483

(2F1Z-9A317-BA)
Black Nylon

Fuel Line Retainer Clip

For 3/8" Fuel Line
Ford Taurus & Mercury Sable
6 Cylinder 3.0 L Engine
with Fuel Injection 2002 - On

UNIT PACKAGE: 25



20482

(2F1Z-9A317-AA)
Natural Nylon

Fuel Line Retainer Clip

For 5/16" Fuel Line
Ford Taurus & Mercury Sable
6 Cylinder 3.0 L Engine
with Fuel Injection 2002 - On

UNIT PACKAGE: 25



17643

(N802239-S, N806191-S1901)
Natural Nylon

Fuel Line Retainer Clip

For 5/16" Fuel Line
Ford with Fuel Injection 1980-On

UNIT PACKAGE: 25



17642

(N802241-S, N806190-S1901)
Black Nylon

Fuel Line Retainer Clip

For 3/8" Fuel Line
Ford with Fuel Injection 1980-On

UNIT PACKAGE: 25



21214

(4F1Z-9A317-AA)
White Nylon

Fuel Line Retainer Clip

Head Size: 3/8" x 5/8"
Overall Height: 21/32"
For 5/16" Fuel Line Hose
Taurus 2004 - On

UNIT PACKAGE: 15



25049

(Ford: Not Supplied By O.E.M.)

**Fuel Filter Return Line
Repair Connector**

Barb Length: 14mm
Barb Diameter: 4.6mm
Overall Length: 43.9mm
6.7L Powerstroke
Engines 2017 - On

UNIT PACKAGE: 1



25350

(Ford: W719957-S300)
White Nylon

Bumper Side Extension

Retainer with Sealer
Top Head Size: 11mm x 15mm
Top Head Height: 8mm
Bottom Head Size: 16mm x 20mm
Stem Size: 8mm x 16mm
Stem Length: 15mm
Overall Height: 24mm
Fits into 8mm x 12mm Slot
Lincoln Aviator, Ford Escape 2020-On

UNIT PACKAGE: 10



16954

(386299-s)
Nylon

Hood Prop Rod Clip

Rod Diameter: 5/16"
Ford Cars 1975-On

UNIT PACKAGE: 25

22891

(Ford: AM5Z-16828-A)
Yellow Nylon

Hood Prop Rod Clip

Holds 9mm Prop Rod
Fits into 7mm x 10mm Slot
Ford C-Max, Escape
& Focus 2012 - On
GT 2017 - On

UNIT PACKAGE: 25



22304

(W715544-S300)
Black Nylon

Hood Release Cable Clip

Holds 6.3mm (1/4") Dia. Tube/Cable
Fits into 7mm Hole
Overall Height: 21mm
Ford Edge, F-150, Fusion & Mustang
and Lincoln MKZ 2010 - On

UNIT PACKAGE: 25



18102

(Ford: N806624-S191;
Chry: 6502776)

Rear Light Assembly Retainer

Ford Explorer 1991-On

UNIT PACKAGE: 25



22289

(GM: 11570654; Chrysler: 6509432AA
Ford: W716529-S900)
Magni-565 Blue Finish

Radiator Grille Nut

Screw Size: M4.2-1.41 (#8)
Head Size: 6mm x 16mm
Overall Height: 7mm

Buick Allure, Enclave, Encore, LaCrosse,
Lesabre, Lucerne, Rainer, Regal & Verano and
Cadillac ATS, CTS, Deville, DTS, ELR,
Escalade, SRX & STS 2000 - On
Chrysler 200, 300, PT Cruiser, Sebring, Town & Country
and Dodge Avenger, Caliber, Charger, Dart, Grand
Caravan, Ram 2500 & Ram 3500 2015 - 2006
Ford 250, 350, 450 & 550
Super Duty Trucks 2015 - 2013

UNIT PACKAGE: 25

14820

(N803685S)

Dash Panel Nut

Screw Size: #8 (M4.2-1.41)
Taurus/Sable

UNIT PACKAGE: 25



25352

(Ford: W713617-S439)
Zinc

Specialty Nut with Silicon Rubber Seal

Screw Size: M4.2-1.41
Width: 11.7mm
Overall Height: 8mm
Replaces Auveco No. 22272
Ford Escape, Explorer, Flex, Fusion, Mustang,
Ranger & Taurus and Lincoln MKS, MKT,
MKZ, Milan & Zephyr 2009 - On

UNIT PACKAGE: 15



22874

(GM: 11546868)
Zinc Organic

Door Panel, Bumper, Lamps & Deck Lid Nut with Silicone Pad

Screw Size: M4.2-1.41 (#8)
Head Size: 12mm x 16mm
Stem Length: 6.5mm

Buick Allure, Enclave, Encore, Envision, LaCrosse, Rainier,
& Regal, Cadillac ATS, CT6, CTS, ELR, Escalade, SRX, XT5
& XTS, Chevrolet Bolt EV, Camaro, Cobalt, Colorado,
Cruze, Equinox, HHR, Impala, Malibu, Orlando, Silverado,
Sonic, Spark, Spark EV, SS, Suburban, Tahoe, Trailblazer,
Traverse, Trax & Volt, GMC Acadia, Canyon,
Envoy, Sierra, Terrain & Yukon 2008 - On
Hummer H2, H3 & H3T 2010 - 2003
Pontiac G5 & Saturn Outlook 2010 - 2007

UNIT PACKAGE: 15





22818

(Ford: W715197-S439)
Zinc Organic

**Front & Rear Bumper
Specialty Nut with Pasticol Pad**

Screw Size: M4.8-1.6
Head Size: 14mm x 23mm
Stem Length: 7mm
Ford Edge, Escape, Expedition,
Explorer, Fusion, Mustang & Transit and
Lincoln Continental, MKC, MKS, MKX, MKZ &
Navigator 2011 - On

UNIT PACKAGE: 10



22844

(Ford: W714171-S439)
Zinc Organic

**Door & Under Cover Nut
with Silicon Rubber Sealer**

Screw Size: M4.2-1.41
Head Size: 12mm x 16mm
Stem Length: 6.5mm
Ford Edge, Expedition & Focus and
Lincoln MKC, MKX & Navigator 2015 - On
Escape 2013 - On

UNIT PACKAGE: 10



23888

(N807455-S100)
Phosphate Metal

Lower Grille Clip

Ford Explorer 1996 - On

UNIT PACKAGE: 15



17003

(Ford: F32Z-17C756-S
Mazda: GJ21-50-049)

**Bumper Cover Retainer
Front & Rear Bumpers**

Ford Festiva and
Mazda 1988 - On

UNIT PACKAGE: 50



24617

(Ford N803749-S32B; GM 22520702,
15594541; Chrysler 6032268)
Metal

**Door & Quarter Panel, Center Console
& Interior Trim and Cowl Vent Cover,
Instrument Panel Retainer**

GM, Ford, Chrysler

UNIT PACKAGE: 25



22840

(Ford: W716165-S439)
Zinc Organic

Door Vent Moulding Clip

Width: 11mm
Length: 13.9mm
Fits into 7mm x 18mm Slot
Ford Ranger 2019 - On

UNIT PACKAGE: 25



25281

(Ford: W716909-S439)
Silver Magni-565

Interior Trim Panel Fastener

Width: 15mm
Length: 19.5mm
'U' Width: 10mm
Ford Expedition 2018 - On, F150 2015 - On,
F250 & F350 2017 - On, Mustang 2021 - On;
Lincoln Navigator 2018 - On

UNIT PACKAGE: 50



25282

(Ford: W718226-S451)
Black E-Coat

Door & Interior Trim Panel Fastener

Width: 7.5mm
Length: 12mm
'U' Width: 7.9mm
Lincoln Aviator & Corsair 2020 - On,
Navigator 2018 - On

UNIT PACKAGE: 50



25280

(Ford: W716053-S451)
Black Phosphate

Cowl & Interior Trim Fastener

Width: 12mm
Length: 10.7mm
'U' Width: 3.5mm
Ford Bronco 2021 - On, Escape 2020 - On;
Lincoln 2020 - 2017, Corsair 2020 - On,
Navigator 2018 - On

UNIT PACKAGE: 50



25277

(Ford: W714113-S439)
Silver Magni-565

Interior Trim Panel Fastener

Width: 12mm
Length: 18.3mm
'U' Width: 4.9mm
Ford F150 2019 - 2015, F250-F550 2017 - On, Focus 2008,
Fusion 2020 - 2013, Ranger 2020 - 2019,
Ranger 2019 - On; Lincoln Continental 2020 - 2017,
MKC 2019 - 2015, MKX 2018 - 2016,
MKZ 2016 - 2013, Nautilus 2019 - On

UNIT PACKAGE: 50



25278

(Ford: W715801-S439)
Silver Magni-565

Bumper Fastener

Width: 12mm
Length: 15.3mm
'U' Width: 3.5mm
Ford Ranger 2019 - On

UNIT PACKAGE: 50



25279

(Chrysler: 68139270AA;
Ford: W715980-S439)
Silver Magni-565

Interior Trim Panel Fastener

Width: 12mm
Length: 15.5mm
'U' Width: 3.8mm

Chrysler 200 2017 - 2015, Pacifica 2017 - On,
Voyager 2020 - On; Dodge Challenger 2018 - On,
Dart 2016 - 2015; Jeep Cherokee 2014 - On,
Wrangler 20201 - On; Ford F150 2015 - On,
F250, F350 2017 - On, Focus 2003

UNIT PACKAGE: 50



19421

(F7UZ-1513284-BA)
Zinc Organic

Front Door Scuff

Plate Retainer
Econoline Van E150/350 1997-On

UNIT PACKAGE: 25



23786

**Door & Quarter Glass
Outer Weather Strip Clip**
GM, Ford & Chrysler
Some Imports

UNIT PACKAGE: 50



21745

(GM: 11609651)
Zinc

**Windshield Garnish and
Interior Trim Moulding Fastener**

Screw Size: M4.2 (#8)
Stem Width: 13mm
Head Size: 13.5mm x 20.5mm
Overall Length: 22mm
Ford Flex & Taurus, Dodge, GM,
Kia & Suzuki 2004 - On

UNIT PACKAGE: 15



20396

Yellow Zinc

1/4" - 20 Specialty Insert
Grip: .030" - .165"
Head Diameter: 1/2"
Hex Size: 3/8"

UNIT PACKAGE: 15



20421

(N811257-S100)
Olive Drab Zinc

M5-.8 Specialty Insert with Sealer

Grip: .5mm-2.5mm,
Head Diameter: 10mm
Hex Size: 7mm
General Purpose

Ford Escape, Excursion,
Expedition, Explorer, Navigator & Mountaineer 2001 - On

UNIT PACKAGE: 15



20678

Yellow Zinc

M5-.8 Specialty Insert
Grip: .5mm-3.3mm
Head Diameter: 10mm
Hex Size: 7mm

UNIT PACKAGE: 15



20401

(W706172-S309,W708384-S309)
Yellow Zinc

M6-1.0 Specialty Insert with Sealer
Grip: .5mm-4.2mm
Head Diameter: 13mm
Hex Size: 9.5mm (3/8")

Roof Rack

Ford Escape, Excursion, Expedition, Explorer, Navigator &
Mountaineer 2000 - On

UNIT PACKAGE: 15



21215

(W710791-S437)
Zinc

**Quarter Glass & Luggage Rack
Specialty Insert with Sealer**

Thread: M6-1.0

Grip: .51mm - 3.18mm

Head Diameter: 13mm

Hex: 9.5mm (3/8")

Expedition & Navigator 2007 - On

UNIT PACKAGE: 15



20415

(GM: 15685099;
Ford: N803763-S100)
Yellow Zinc

M6-1.0 Specialty Insert with Sealer
Grip: .65mm - 2.0mm
Head Diameter: 12mm

Hex Size: 8mm

Roof Rack, Tailgate & General Purpose

GM APV Vans, C & K Trucks & Ford Explorer 1991 - On

UNIT PACKAGE: 15



19436

(N808182-S309)
Yellow Zinc

Roof Rack Mounting Nut Insert

Thread : M6 - 1.0

Grip: .7mm - 3.17mm

Head Diameter: 13mm

Explorer & Expedition 1997-On

UNIT PACKAGE: 10



20776

(W708513-S437)
Zinc

M8-1.25 Specialty Insert

Grip: .7mm - 3.8mm

Head Diameter: 22mm

Hex Size: 12.7mm (1/2")

Frame Area

Ford Trucks 2004 - On

UNIT PACKAGE: 15



25348

(Ford: W714241-S300)
Black Nylon

**Rear Wheel Apron & Trunk
Trim Slot Drive Cap Nut**

Fits onto M6-1.0 stud
Overall Height: 19mm

Ford Mustang 2015 - On,
Police Interceptor 2019 - 2014,
Taurus 2019 - 2010; Lincoln
MKS 2016 - 2009; Mercury Milan 2011 - 2010

UNIT PACKAGE: 25



23968

Nylon

Door Lock Button Grommet

Airlane, Falcon, Mustang 1965 - 1973

UNIT PACKAGE: 50



10262

Nylon

**Door Lock Rod & Hood
Latch Locking Push Rod Clip**

Rod Size: 5/32"

Fits into 1/4" Hole

Chrysler, Ford, GM & AMC

UNIT PACKAGE: 20 Pieces

10 Rights - 10 Lefts



Left-Hand Side



Right-Hand
Side

14967

(AMC: 4003673L;

Chry: 2945109L, 4658677;

GM: 9815325, 16607593;

Ford: D2VZ-6521952A, N804344S)

Black Nylon

Clip for Left-Hand Side Only

UNIT PACKAGE: 50



15675

(E6AZ-5421952-A, 390523S)
Yellow Nylon

Door Lock Rod Clip

Rod Size: 5/32"

Ford Products 1986-On

UNIT PACKAGE: 25



17122

(E6DZ-5421952A,
E83Z-5421952B)

White Nylon

Door Lock Rod End Clip

Rod Size: 5/32"

Taurus, Sable, Tempo, Topaz, T-Bird
& Cougar, Aerostar, Bronco, Explorer,
Mountaineer, Pick-Up, Ranger &
Windstar 1986-On

UNIT PACKAGE: 10



18914

(Not Supplied by O.E.M.)
PVC Plastic

Door Lock Striker Bushing

Inner Diameter: 1/2"

Outer Diameter: 11/16"

Length: 7/8"

Ford 1972-On

UNIT PACKAGE: 50



18890

(3W7Z-5422008-AA,

6W1Z-5422008-A,

E9FZ-5822008-A,

F67Z-7822008-AA,

XW1Z-5422008-AA)

Door Lock Striker

Bolt Assembly

Thread: M10-1.50

Ford, Lincoln &

Mercury 1980-On

UNIT PACKAGE: 1



18891

(E9AZ-5422008-A;

XW1Z-5822008-AA)

Door Lock Striker

Bolt Assembly

Thread: 7/16-14

Ford, Lincoln &

Mercury 1983-On

UNIT PACKAGE: 1

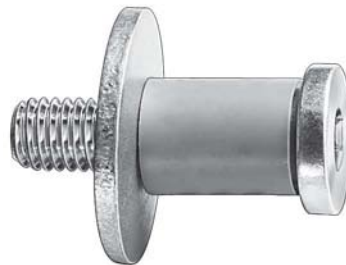

18892

(D2AZ-6522008-A)

Door Lock Striker

Bolt Assembly

Thread: 7/16"-14

Cars 1980-73

E100/350 Vans

(Back Door) 1986-80

UNIT PACKAGE: 1



14550

(GM: 9721917;

Ford: DIAZ-6522841A)

Inner Diameter: 11/32"

Outer Diameter: 27/64"

Height: 19/64"

Flange Outer Diameter: 19/32"

Buick (Exc. Skyhawk) 1967-On

Cadillac 1946-On

Chevrolet: Exc. Monza & Vega 1962-On,

Corvette 1956-On, GM C & K Trucks 1993 - 79

Olds Exc. Starfire 1949-On

Pontiac: Exc. Astre & Sunbird 1932-On

UNIT PACKAGE: 25



14551

(D90Z-6522841A)

Inner Diameter: 11/32"
Outer Diameter: 31/64"
Height: 19/64"
Flange Outer Diameter: 19/32"
Ford 1973-On

UNIT PACKAGE: 25

24542



Door Hinge Pin & Bushing Kit

Contains: Two 24562 (3152)
Four 16936 (2741) & Two 8829 (2648)
Ford Cars, Trucks, Vans 1994 - On

UNIT PACKAGE: 4

20346

(Not Available from O.E.M.)
Yellow Zinc



Photo not actual size

Door Hinge Pin

Length: 3-1/2"
Pin Diameter: 11/32"
Knurl Diameter: .358"
Head Outer Diameter: 9/16"
Ranger, F150, F250 & F350 1998 - 80

UNIT PACKAGE: 5

24519



Door Hinge Pin & Bushing Kit

Contains: Two 20346 (2943) Door Hinge Pin,
14551 (2327) Bushing &
8829 (2648) E Type Retaining Rings
Ford

UNIT PACKAGE: 2

13030

(E2GZ-6723342A)
Black Nylon



Photo not actual size

Window Crank Handle

UNIT PACKAGE: 1

23709

(D3AZ-6523342-A)



Window Regulator Handle

Mustang 1973 - 1974
Full Size Ford & Maverick 1973 - 1977
Thunderbird 1977
LTD II 1978

UNIT PACKAGE: 12

12470

(D1FZ-6222600-A,
D2FZ-6222600-A)



Photo not actual size

Door Handle

UNIT PACKAGE: 1

25474

(Ford: KU5Z-14A163-C)
Black Nylon

Photo not actual size

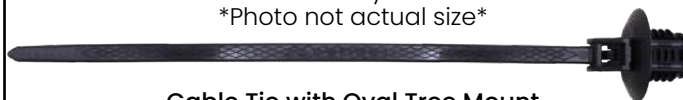

Cable Tie with Oval Tree Mount

Length: 166mm (6-1/2")
Bundle Dia.: 1.5mm - 35.0mm (0.059" - 1.38")
Fits into 6.5mm x 12.5mm Oval (1/4" - 1/2") Hole
All-in-one bundling and fastening solution
Reduces costs and assembly time
Disc feature provides anti-rattle protection
in high-vibration applications
Ford & General Purpose

UNIT PACKAGE: 15

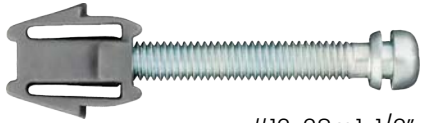

10760
(3574085)
Gray Nylon

#12-28 x 1-1/2"
**Headlight Adjusting Screw
& Nut Assembly**
Chrysler 1972 - On
UNIT PACKAGE: 10

11653

Same as 10760 except for unit package quantity
UNIT PACKAGE: 25

11654

Same as 10760 except for unit package quantity
UNIT PACKAGE: 100



23285

(Not Available from OEM)

1/4"-28 x 1"
Headlight Adjusting Nut & Screw
American Motors Cars 1969 - 1972

UNIT PACKAGE: 25



23895

(4762490)
Nylon

Headlight Adjusting Pivot Nut
Hole: 12mm Sq.
Chrysler 1991 - 1995
UNIT PACKAGE: 10

13466

(6032516)
Black Nylon



License Plate Nut
Screw Size: #12
Chrysler

UNIT PACKAGE: 25



9377

(Chry: 6000943;
AMC: 8934-201-263)
White Nylon

Radiator Grille Nut
Screw Size: #8
Chrysler & AMC-Renault

UNIT PACKAGE: 100



12735

(GM: 1370853; Chry: 6029501;
VW: 179-813-883)
Natural Nylon

Headlight Bezel Nut
Screw Size: #6

UNIT PACKAGE: 50



10305

Nylon

Nylon Nut
Screw Size: #8

UNIT PACKAGE: 50



24462

Door Trim Screw Grommet

Head Size: 22.5mm

Hole Size: 12mm

Overall Length: 21mm

Ford Contour & Mystique

UNIT PACKAGE: 25



19485

(6027958)

Natural Nylon



**License Plate Nut & Door Lock
Remote Control Switch Bracket Nut**

Screw Size: #14 (1/4")

Fits into 3/8" x 3/8" Hole

Chrysler 1984 - On

UNIT PACKAGE: 10



12569

(Ford: N801706-S;
Chry: 6501773)
Black Nylon



Screw Size: #12
Ford 1981 - On

UNIT PACKAGE: 25



21236

(6508072-AA)
Black Nylon

Headlight Nylon Nut

Screw Size: M5.5 (#12)

Head Size: 15mm x 15mm

Stem Length: 10mm

Fits into 10.5mm x 11mm Hole

Jeep Grand Cherokee &
Commander 2005 - On

UNIT PACKAGE: 50



14756

(Chry: 6033677;
Ford: 379830-S)
Black Nylon

Screw Size: #8

Width: 3/8"

Length: 3/8"

Panel Thickness: 1/4"

Fits into 9/32" x 9/32" Hole

Chrysler & Ford 1986-On

UNIT PACKAGE: 25



20179
(6035401)
Nylon

Door Trim Panel Nylon Nut
Screw Size: M4.2 (#8)
Head Size: 16mm x 16mm
Stem Length: 10mm
Caravan, Town & Country
and Voyager 1996 - On

UNIT PACKAGE: 25



14218
(6031183)
Black Nylon

Screw Size: #6 or #8
Chrysler

UNIT PACKAGE: 50



19793
(6504072)
Black Nylon

Tail Light Housing Grommet
Head Diameter: 16mm
Stem Length: 10mm
Snaps into 12mm Hole
Dakota & Ram Trucks 1997 - On

UNIT PACKAGE: 25



12566
(Chry: 6032061;
GM: 25508532)
Black Nylon

Grille attachment Grommet
Chrysler & GM 1981-On

UNIT PACKAGE: 25



12713
(Chry: 6031869;
GM: 1264963;
AMC: 8934-201-602)
Nylon

High Torque Screw Gro Grommet
Chrysler, GM
& AMC-Renault

UNIT PACKAGE: 25



14037
(GM: 15596280;
Chry: 6035274)
Black Nylon

Cowl Vent Nut
Screw Size: #6 or #8

UNIT PACKAGE: 25



23971
(MS-480003, 791084000)
White Nylon

Interior Trim Screw Gro Grommet
Screw Size: M4.8 (#10)
Head Diameter: 15mm
Fits into 8.5mm Size
Chrysler Arrow, Colt, Subaru
Other Japanese Models

UNIT PACKAGE: 25



20667
(4860375-AB)
White Nylon

Cowl Vent Gro Grommet
Screw Size: M4.8 (#10)
Head Size: 14mm x 20mm
Caravan, Town & Country and
Voyager Mini-Vans 2004 - On

UNIT PACKAGE: 50



18825
(6503373)
Black Nylon

Cowl & Dash Panel Screw Gro Grommet
Screw Size: #8
Cirrus & Stratus 1995-On

UNIT PACKAGE: 15



23885
(Chrysler: 6501773)
Nylon

Tail Lamp Gro Grommet
Screw Size: M6
Head Diameter: 17.75mm Sq.
Snaps into 10mm Hole
Chrysler Cirrus, Stratus 1996 - On

UNIT PACKAGE: 50



20275
(Not Supplied by O.E.M.)
White Nylon

Door Panel Gro Grommet
Head Diameter: 19mm
Stem Length: 12mm
Fits into 9mm Hole
Use with Auveco 20274
LH Series 2000 - On

UNIT PACKAGE: 25



20468
(6506852-AA)
Green Nylon

Trim Panel Gro Grommet
Head Diameter: 17mm
Stem Length: 12mm
Fits into 8mm Hole
Sebring & Stratus 2001 - On

UNIT PACKAGE: 50



21231
(4784018-AA)
Green Nylon

Door Panel Gro Grommet
Head Diameter: 19mm
Stem Length: 12mm
Fits into 9mm Hole
Use with Auveco 20274
Chrysler LH Series 2000 - On

UNIT PACKAGE: 25



25438

(Chrysler: 68138992-AA)
White Nylon

Door Panel Grommet with Sealer

Head Size: 22mm
Stem Length: 13mm
Overall Height: 16mm
Fits into 9mm Hole

Chrysler 200 2017 - 2015, 300 2011 - On;
Dodge Challenger 2016 - 2015 & 2022,
Charger 2011 - On, Durango 2015, Viper 2017; Jeep
Cherokee 2015, Grand Cherokee 2021 - On,
Wrangler 2018 - 2014

UNIT PACKAGE: 25



21213

(Not Available from O.E.M.)
Black Nylon

Tail Light Assembly Grommet

Head Diameter: 19mm
Stem Length: 11mm
Fits into 12mm Hole

Dodge Pick-Ups 1500 & 2500 Series 2006 - On

UNIT PACKAGE: 25



20525

(Not Available from O.E.M.)
Black Nylon

**Headlight Mounting
Panel Grommet**

Head Size: 16mm x 22mm
Stem Length: 20mm

Jeep Grand Cherokee 1999 - On

UNIT PACKAGE: 25



22577

(Chrysler: 68211658-AD)
White Nylon

Headlamp Mounting Grommet

Head Size: 16mm x 23mm
Overall Length: 12mm
Fits into 10mm x 18mm Hole

Accepts 7mm Diameter Ball Stud
Jeep Cherokee 2014 - On

UNIT PACKAGE: 25



20581

(MR478263)
Black Rubber

**Bumper Cover & Garnish Moulding
Grommet with Sealer**

Head Diameter: 16mm
Stem Length: 20mm
Fits into 9mm Hole

Use with Auveco 20580

Sebring & Stratus and Mitsubishi Eclipse 2000 - On

UNIT PACKAGE: 15



22028

(4806271-AA)
Black Rubber

**Rear Lamp Mounting, Sensor
Bracket & Interior Trim Grommet**

Head Diameter: 15mm
Stem Length: 21mm
Overall Length: 25mm
Fits into 9mm Hole

Chrysler Mini-Van and Jeep 200,
Caliber, Compass & Patriot 2007 - On

UNIT PACKAGE: 15

25217

(Chrysler: 6507009AA; Ford: W712990-S300)
White Nylon



Door Trim Panel Grommet with Sealer

Screw Size: M4.2 (#8)
Head Size: 15mm x 15mm
Stem Length: 20mm
Overall Height: 21mm
Fits into 9mm Sq. Hole

Chrysler Aspen 2009 - 2007; Dodge Durango
2009 - 2004; Jeep Commander 2010 - 2006,
Grand Cherokee 2007 - 2003,

Liberty 2007 - 2002, Wrangler 2007 - On;
Ford Taurus, Taurus X & Mercury Sable 2009 - 2008

UNIT PACKAGE: 25



20962

(55156879-AB)
Black Nylon

Tail Light Grommet

Head Size: 20mm x 31mm
Receives 10mm Ball Stud
Jeep Commander 2006 - On

UNIT PACKAGE: 25



20964

(5159077-AA)
Black Nylon

Rear Bumper Clip

Stem Length: 15/32"
Overall Length: 31/32"
Jeep Grand Cherokee 2005 - On

UNIT PACKAGE: 25



17195

(Isuzu: 8942180270)
Black Nylon

Grille Clip

Width: 13mm
Length: 22mm

Ford Escort, Honda, Isuzu,
Mitsubishi & Plymouth Laser

UNIT PACKAGE: 25



23730
(6003817)
White Nylon

Roof Transverse Moulding Clip
Chrysler 1982 - On

UNIT PACKAGE: 25



23637
(6003201)
White Nylon

Body Sill Moulding Clip
Size: 7/8" x 1"
Chrysler 1970 - 1975

UNIT PACKAGE: 100



23721
(6003486)
Nylon

Fender & Door Moulding Clip
Size: 1" x 1-7/32"
Chrysler 1975 - 1980

UNIT PACKAGE: 100



13927
(6003774, 6003965)
Nylon

Body Side Moulding Clip
Chrysler 1981-On

UNIT PACKAGE: 25



11354
(6003147)
Nylon

Moulding Clip
Chrysler 1976-On

UNIT PACKAGE: 25



23657
(381090)
White Nylon

Sill Moulding Clip
Size: 1-7/32" x 5"
Chrysler

UNIT PACKAGE: 50



17151
(6004036)
Nylon

Window Reveal Moulding Clip
Chrysler LeBaron & Maserati 1987-On
UNIT PACKAGE: 15



21791
(68213168AA)
Black Nylon

Grille Moulding Clip
Flange Diameter: 20mm
Stem Diameter: 13mm
Stem Length: 12mm
Overall Length: 31mm
Dodge Ram 1500 2013 - On
UNIT PACKAGE: 15



21835
(68225214AA)
White Nylon

Moulding Clip
Head Size: 11.5mm x 21mm
Stem Length: 11mm
Overall Height: 17mm
Jeep Cherokee 2014 - On
UNIT PACKAGE: 50



19894
(5FR56DX9)
Black Nylon

Rocker Panel Clip
Head Size: 7/16" x 25/32"
Stem Length: 5/8"
Jeep Grand Cherokee 1999 - On

UNIT PACKAGE: 25



20523
(55156429-AA)
Black Nylon

Rocker Panel & Bumper Fascia Clip
Top Head Size: 1/2" x 1-3/16"
Stem Length: 27/32"
Jeep Liberty 2002 - On

UNIT PACKAGE: 10



21154
(5189180-AA)
Black Nylon

Front Fender Flare Moulding Clip
Top Head Size: 13mm x 31mm
Bottom Head Size: 14mm x 22mm
Stem Length: 22mm
Jeep Commander 2006 - On

UNIT PACKAGE: 15



22929
(Chrysler: 68146440AA)
Black Nylon

Wheel Opening Flare Moulding Clip
Top Head Size: 12.75mm x 31mm
Bottom Head Size: 13.75mm x 22mm
Stem Diameter: 8mm x 14mm
Stem Length: 21mm
Overall Height: 26.3mm
RAM Pick-Up 4500 & 5500 2018 - 2011

UNIT PACKAGE: 15



20828
(55157070-AC)
Black Nylon

Rocker Moulding Clip
Head Diameter: 25mm
Overall Length: 31mm
Fits into 8mm Hole
Jeep Liberty 2002 - On

UNIT PACKAGE: 10



20763
(1BA41AX1-AA)
Black Nylon

Rocker Panel Moulding Clip
Head Size: 12mm x 20mm
Stem Length: 13mm
Chrysler 300 & Dodge Magnum 2005 - On

UNIT PACKAGE: 15



21175
(1BA41XWG-AA)
Cream Color Nylon

Rocker Panel Moulding Clip
Head Size: 12mm x 20mm
Stem Length: 13mm
Fits into 9mm Hole
Chrysler 300 2006 - On

UNIT PACKAGE: 15



21670
(4389940-AB)
Black Nylon

Rocker Panel Moulding Clip
Head Size: 10mm x 20mm
Stem Length: 14mm
Chrysler Sebring &
Dodge Avenger 2007 - On

UNIT PACKAGE: 10



22129
(Not Available from O.E.M.)
White Nylon

Body Side Moulding Clip
Top Head Size: 4mm x 10.5mm
Bottom Head Diameter: 11mm
Stem Length: 10mm
Fits into 7mm Hole
Dodge Dart 2014 - On

UNIT PACKAGE: 25



20870
(68092697AA)
White Nylon

Rocker Panel Moulding Clip
Top Head Size: 9/16" x 13/16"
Bottom Head Size: 9/16" x 23/32"
Stem Length: 5/8"
Dodge Dakota & Durango
and Jeep Liberty 2000 - On

UNIT PACKAGE: 15



20982
(Not Available from O.E.M.)
White Nylon

Fender & Wheel Flare Moulding Clip
Top Head Size: 14mm x 18mm
Bottom Head Size: 17mm x 21mm
Stem Length: 13mm
Fits into 9mm Hole
Jeep Commander 2006 - On

UNIT PACKAGE: 25



25349
(Chrysler: 68499020AA)
White Nylon

Rear Wheel Opening Moulding Clip
Top Head Size: 14mm x 18mm
Bottom Head Size: 15mm x 18mm
Stem Length: 11mm
Fits into 9mm Hole
Ram 1500 2019 - On

UNIT PACKAGE: 25



21223
(6509288AA)
Black Nylon

Rocker Moulding Clip with Sealer
Top Head Size: 21mm x 22mm
Bottom Head Size: 22mm x 22mm
Stem Length: 9mm
Chrysler Grand Caravan
and Town & Country 2008 - On

UNIT PACKAGE: 10



21099
(Not Available from O.E.M.)
White Nylon

Lift Gate Moulding Clip with Sealer
Top Head Size: 12mm x 21mm
Bottom Head Size: 16mm x 18mm
Stem Length: 11mm
Magnum 2006 - On

UNIT PACKAGE: 10



21374
(GM: 11571175;
Chrysler: 68172491AA)
Gray Nylon

Rocker Moulding Clip with Sealer
Top Head Size: 12mm x 20mm
Bottom Head Size: 12mm x 20mm
Stem Length: 11mm
Fits into 9mm Hole
Chevrolet Traverse 2010 - On
Chrysler 200 2015 - On
Jeep Grand Cherokee 2015 - 2012

UNIT PACKAGE: 15



21666
(Not Available from O.E.M.)
White Nylon

Liftgate Spoiler Moulding Clip with Sealer
Top Head Size: 12mm x 23mm
Bottom Head Diameter: 18mm
Stem Length: 11mm
Chrysler and Dodge Mini-Van 2008 - On

UNIT PACKAGE: 15



20827
(55157069-AB)
White Nylon

Rocker Moulding Clip
Top Head Size: 14mm x 27mm
Bottom Head Size: 13mm x 26mm
Stem Length: 15mm
Fits into 9mm Hole
Jeep Liberty 2002 - On

UNIT PACKAGE: 25



21153
(6508947-AA)
Black Nylon

Front Bumper Moulding Clip
Top Head Size: 11mm x 32mm
Bottom Head Size: 15mm x 20mm
Stem Length: 20mm
Fits into 15mm Hole
Jeep Patriot 2007 - On

UNIT PACKAGE: 10



20700
(55156447-AB)
Black Nylon

Ground Effects Moulding Clip
Head Width: 1/2"
Head Length: 1-1/2"
Stem Length: 1/2"
Jeep Liberty 2004 - On

UNIT PACKAGE: 25



22531
(Chrysler: 68283229AA)
Black Nylon

Rocker Moulding Clip with Sealer
Top Head Size: 14mm x 20mm
Bottom Head Size: 14mm x 32mm
Stem Length: 15mm
Fits into 9mm Hole
Chrysler 300 & Dodge Charger
2015 - On

UNIT PACKAGE: 10



21528
(68039280-AA)
Black Nylon

Fender Flare & Rocker Moulding Clip
Top Head Size: 14mm x 38mm
Bottom Head Size: 16mm x 38mm
Stem Length: 14mm
Fits into 10mm Hole
Jeep Wrangler JK & Wrangler Unlimited JK 2007 - On

UNIT PACKAGE: 25



20887
(55157055-AA, 55157065-AA)
Gray Nylon

Fender Flare Moulding Clip with Sealer
Top Head Size: 14mm x 38mm
Bottom Head Size: 16mm x 38mm
Stem Length: 15mm
Fits into 9mm Hole
Jeep Liberty 2005 - On

UNIT PACKAGE: 15



22836

(Chrysler: 68395634AA)
White Nylon

Wheel Flare Retainer

Top Head Size: 14.5mm x 38mm
Bottom Head Size: 16mm x 38mm
Stem Length: 12mm
Fits into 9mm Hole
Jeep Wrangler 2018 - On

UNIT PACKAGE: 10



21738

(55156655-AA)
Black Nylon

Inner Fender Moulding Clip with Sealer

Head Size: 12mm x 38mm
Stem Length: 12mm
Fits into 8mm Hole

Chrysler Sebring, Dodge Avenger & Durango and Jeep Grand Cherokee & Liberty 2007 - 02

UNIT PACKAGE: 25



21155

(5189181-AA)
Black Nylon

Front Fender Flare (Rear) Moulding Clip with Sealer

Top Head Size: 14mm x 40mm
Bottom Head Size: 14mm x 18mm
Stem Length: 15mm
Jeep Commander 2006 - On

UNIT PACKAGE: 10



20771

(4857699-AA)
Black Nylon

Front Bumper Fascia to Grille Retainer

Head Size: 10mm x 42mm
Stem Length: 14mm
Fits into 7.5mm Hole
Chrysler Pacifica 2004 - On

UNIT PACKAGE: 25



18032

(6502573)
Black Nylon

Cowl Screen Attachment Push-Type Retainer

Head Size: 15/32"
Stem Length: 9/16"
Fits into 1/4" Square Hole
Chrysler Concorde & LHS,
Dodge Intrepid & Eagle Vision 1993-On

UNIT PACKAGE: 15



17214

(GM:10089262, 21042098;
Chry: 55075139)
Black Nylon

Push-Type Retainer

Head Diameter: 11mm (7/16")
Stem Length: 18mm (11/16")
Fits into 6mm (15/64") Hole
GM Saturn 4 Door &
Station Wagon 1991 - On

UNIT PACKAGE: 25

14987

Same as 17214 except for unit package quantity

UNIT PACKAGE: 50



22543

(Chrysler: 6509135-AA)
Black Nylon

Cowl Grille & Exterior Trim Push-Type Retainer

Head Diameter: 11mm
Stem Length: 20mm
Fits into 6mm Hole

Dodge Journey & Ram 2011 - On

UNIT PACKAGE: 25



14995

(GM: 10195515;
Ford: N805026S;
Chry: 4696488, 6503163)
Black Nylon

Push-Type Retainer

Head Diameter: 1/2"
Stem Length: 1-13/64"
Fits into 9/32" Hole
Ford, GM & Chrysler 1987 - On

UNIT PACKAGE: 25



14992

(Ford: N803946S;
Chry: 6502871;
Mercedes: 000-991-52-40)
Black Nylon

Door Panel Push-Type Retainer

Head Diameter: 19/32"
Stem Length: 29/32"
Fits into 1/4" Hole
Ford & Chrysler 1987 - On;
Mercedes Metris 2020 - 2016; Sprinter
1500, 2500, 3500 2019 - On

UNIT PACKAGE: 50



16816
(GM: 21047094, Chrysler: 6502632)
Black Nylon

Push-Type Retainer
Top Head Diameter: 14mm
Stem Length: 14mm
Fits into 6mm Hole

GM Saturn SC, SC1, SC2, SL1, SL2, SW1, SW2
1994 - 1991; Chrysler Pacifica 2017 - On;
Voyager 2020; Dodge Charger 2016 - 2015;
Durango 2003 - 2001;
Jeep Grand Cherokee 2014;
Ram 1500, 2500, 3500 2010 - On

UNIT PACKAGE: 25



15672
(8880417)
Black Nylon

Push-Type Retainer
Head Diameter: 17mm
Stem Length: 14mm
Fits into 8mm (5/16") Hole
Chrysler 1987-On

UNIT PACKAGE: 25



14753
(Chry: 4638136; GM: 20664092;
Ford: N804570S)
Black Nylon

Radiator Shroud & Trim Retainer
Push-Type Retainer
Head Diameter: 11/16"
Stem Length: 7/8"
Fits into 1/4" Hole
Chrysler 1998 - On
GM 1982 - On
Ford 1986 - On

UNIT PACKAGE: 25



21680
(6509960AA)
Black Nylon

Bumper Push-Type Retainer
Head Diameter: 18mm
Stem Length: 10mm
Fits into 8mm Hole
Chrysler 300 2011 - On

UNIT PACKAGE: 25



21098
(Chrysler: 6508197-AA;
Ford: W706092-S300)
Black Nylon

Front Air Shield, Splash Guard & Heat Shield Push-Type Retainer
Head Diameter: 18mm
Stem Length: 18mm
Fits into 6.4mm Hole
Dodge Ram 2006 - On
Ford Taurus 2008 - On

UNIT PACKAGE: 25



19140
(Acura: 90505-SL0-003;
GM: 94852368;
Mitsubishi: MB888869;
Toyota: 90467-08155)
Black Nylon

Push-Type Retainer
Head Diameter: 20mm
Stem Length: 21mm
Fits into 8mm Hole

Acura, Dodge Avenger, Eagle Talon, Geo Prizm,
Mitsubishi Eclipse & Galant and Toyota 1993-On

UNIT PACKAGE: 5



16835
(GM: 10140480; Chry: 6502625)
Black Nylon

Push-Type Retainer
Head Diameter: 21mm (27/32")
Shoulder Length: 3mm (1/8")
Stem Length: 25mm (1")
Fits into 12mm (1/2") Hole

UNIT PACKAGE: 25



11704
(6031383)
Black Nylon

Grille Retainer
Head Diameter: 11/16"
Stem Length: 7/16"
Fits into 9/32" Hole
Chrysler 1978-On

UNIT PACKAGE: 25



11699
(GM: 472434; Chry: 6031390)
Black Nylon

Cowl Ledge Weatherstrip & Fender Liner Push-Type Retainer
Head Diameter: 11/16"
Stem Length: 5/8"
Fits into 1/4" Hole
GM 1970-On
Chrysler 1968-On

UNIT PACKAGE: 50



20273
(Ford: N808791;
Chry: 5GC71RC3AA, 5GF92RC3AA)
Gray Nylon

Interior Trim, Dash & Console Push-Type Retainer
Head Diameter: 19mm
Shoulder Diameter: 10mm
Shoulder Length: 7mm
Stem Length: 22mm
Fits into 9mm Hole
Dodge Durango & Ford Pick-Ups 1997 - On

UNIT PACKAGE: 25



20739
(WX68DX9-AA)
Black Nylon

Door Trim Panel Push-Type Retainer
Head Diameter: 22mm
Stem Length: 10mm
Fits into 9mm Hole
Chrysler 300 & Dodge Magnum 2005 - On

UNIT PACKAGE: 25



21021
(OWX68BD5-AA)
Dark Gray Nylon

Door Trim Panel Push-Type Retainer
Head Diameter: 22mm
Stem Length: 10mm
Fits into 9mm Hole
Charger, Magnum & 300M 2005 - On

UNIT PACKAGE: 25



21427
(OWX68XDB-AA)
Light Gray Nylon

Door Trim Panel Push-Type Retainer
Head Diameter: 22mm
Stem Length: 10mm
Fits into 9mm Hole
Chrysler 300M, Charger & Magnum 2005 - On

UNIT PACKAGE: 25



20948
(OWX68BD1-AA)
Tan Nylon

Door Trim Panel Push-Type Retainer
Head Diameter: 22mm
Stem Length: 10mm
Fits into 9mm Hole
Chrysler 300M and Dodge
Charger & Magnum 2005 - On

UNIT PACKAGE: 25



12567
(GM: 14019205, 14019206, 16514113;
Chry: 34201621, 6504090)
Black Nylon

**Front Fender Mud Skirt
& Fender Liner Push-Type Retainer**
Head Diameter: 11/16"
Stem Length: 9/16"
Fits into 1/4" Hole
GM 1981 - On
Chrysler

UNIT PACKAGE: 25

14007

Same as 12567 except for unit package quantity

UNIT PACKAGE: 50



18327
(6503454)
Black Nylon

Front Bumper Fascia Push-Type Retainer
Head Diameter: 11/16"
Stem Length: 5/8"
Fits into 1/4" Hole
Jeep Grand Cherokee 1994 - On

UNIT PACKAGE: 25



14010
(GM: 14045480; Chry: 6508746-AA)
Black Nylon

Fascia Retainer
Head Diameter: 1"
Stem Length: 23/32"
Fits into 3/8" Hole
GM 1982 - On
Chrysler 2009 - On

UNIT PACKAGE: 25



14016
(GM: 16500308; Chry: 6500787)
Black Nylon

Tail Light Retainer
Top Head Diameter: 3/8"
Stem Length: 7/16"
Fits into 3/16" Hole
GM & Chrysler

UNIT PACKAGE: 25



20580
(MR478262)
Black Nylon

**Bumper Cover & Garnish Moulding
Push-Type Retainer**

Top Head Diameter: 15mm
Bottom Head Diameter: 14mm
Stem Length: 12mm
Fits into 7mm Hole

Use with Auveco 20581
Sebring & Stratus and
Mitsubishi Eclipse 2000 - On

UNIT PACKAGE: 15



19801
(GM: 21077123; Chry: 6509103AA)
Ford: W705436-S300)
Black Nylon

**Wheel Opening Moulding
Push-Type Retainer**

Head Diameter: 19/32" (15mm)
Stem Length: 3/4" (19mm)
Fits into 1/4" (6mm) Hole
Saturn 1991 - On
Ford 2002 - On
Chrysler 2010 - On

UNIT PACKAGE: 25



19639
(GM: 15149708; Chry: 6506008AA; Ford: W709176-S300)
Black Nylon

Radiator, Wheelhouse, Fender & Front Bumper Cover, Grille, Rocker Push-Type Retainer

Head Diameter: 17mm
Stem Length: 16mm
Fits into 6mm Hole

GM C & K Trucks 1999 - On; Jeep Liberty 2002 - On; Ford Explorer 2010 - 2007, F150 2009 - On, Mustang 2014 - 2005, Transit 2015 - On

UNIT PACKAGE: 25



18030
(Chry: 6501925; GM: 10134407, Ford: W717870-S300)
Black Nylon

Push-Type Retainer

Head Size: 11/16"
Stem Length: 13/16"
Fits into 1/4" Hole

Chrysler Concorde & LHS
Dodge Intrepid & Eagle Vision 1993-On
Coolant Recovery Reservoir; GM 1992-On;
Ford Edge 2015 - On, Ranger 2019 - On,
Bronco 2021 - On, Lincoln Nautilus 2019 - On,
MKX 2018 - 2016

UNIT PACKAGE: 25



13993
(GM: 20510029;
Ford: N803362-S;
Chry: 34202672)
Black Nylon

Body Retainer

Head Diameter: 11/16"
Stem Length: 7/8"
Fits into 1/4" Hole

GM 1984-On
Ford 1984 - On
Chrysler 1984 - On

UNIT PACKAGE: 25



20988
(GM: 11589289;
Chrysler: 6508863-AA;
Ford: W713610-S300)
Black Nylon

Air Distributor & Windshield Defroster Push-Type Retainer

Head Diameter: 18mm
Stem Length: 17.5mm
Panel Range: 2.0mm - 4.5mm
Fits into 6.5mm Hole

Buick Enclave, Chevrolet Equinox,
Chevrolet & GMC S & T Trucks, GMC Acadia and
Pontiac Torrent 2002 - On;
Ford EcoSport 2018 - On; Edge 2015 - On;
Fusion 2013 - On; Ranger 2019 - On;
Transit 2014 - On; Escape 2019 - 2013;
Expedition 2019 - 2018; Mustang 2019 - 2015;
C-Max 2018 - 2013; Focus 2018 - 2008;
Bronco 2021 - On; Lincoln Nautilus 2019 - On;
MKC 2019 - 2015; MKZ 2019 - 2013;
Navigator 2019 - 2018; Continental 2018 - 2017

UNIT PACKAGE: 25



22354
(6510139-AA)
Black Nylon

Exterior Trim, Floor, Pillar & Quarter Panel Push-Type Retainer

Head Diameter: 18mm
Stem Length: 18mm
Fits into 7mm Hole
Dodge Challenger & Charger 2011 - On



UNIT PACKAGE: 25



20966
(5160260-AA)
Black Nylon

Rear Bumper, Tail Light and Fender Push-Type Retainer

Bottom Head Diameter: 18mm
Stem Length: 20mm
Fits into 8mm Hole
Dodge Caliber and
Jeep Compass & Patriot 2007 - On

UNIT PACKAGE: 15



20888
(GM: 11589290;
Chry: 6509049AA)
Black Nylon

Fender, Wheel & Bumper Push-Type Retainer

Head Diameter: 18mm
Stem Length: 20mm
Panel Range: 3.0mm - 5.8mm
Fits into 9.5mm Hole
GM 2004 - On

Jeep Wrangler 2000 - On
Chrysler Charger & 300 2011 - On

UNIT PACKAGE: 25



19422
(6504521)
Black Nylon

Fascia Push-Type Retainer

Head Diameter: 23/32"
Stem Length: 29/32"
Fits into 5/16" Hole

LHS, Concorde, Intrepid & Eagle Vision 1998-On

UNIT PACKAGE: 25



20768
(4806240AA)
Black Nylon

Rear Bumper Push-Type Retainer

Large Head Diameter: 18.5mm
Stem Length: 21mm
Fits into 8mm Hole
Chrysler 300 & Dodge Magnum 2005 - On

UNIT PACKAGE: 10



20990

(GM: 15296830;
Chrysler: 5116530-AA)
Black Nylon

**Fascia & General Purpose
Push-Type Retainer**
Head Diameter: 19mm
Stem Length: 16mm
Panel Range: 5.0mm - 7.0mm
Fits into 8mm Hole
GM 2007 - On
Chrysler

UNIT PACKAGE: 25



19245

(5BB14LX9)
Black Nylon

**Fascia to Front Bumper
Push-Type Retainer**
Top Head Diameter: 3/4"
Stem Length: 1-1/8"
Fits into 1/4" Hole
Dodge Dakota 1994-On

UNIT PACKAGE: 25



21086

(Mercedes-Benz: 230-990-01-92;
Chry: 6104900-A)
Black Nylon

**Hood Insulation & Cowl Grille
Push-Type Retainer**
Head Diameter: 20mm
Stem Length: 10mm
Fits into 8mm Hole
Mercedes GL, M, R, SL & SLK 2005 - On
Chrysler 2010 - On

UNIT PACKAGE: 15



25324

(Chrysler: 68053681AA)
Natural Nylon

**Lower Bumper Deflector Push-Type
Retainer**
Head Diameter: 20mm
Stem Length: 13.4mm
Stem Diameter: 11.5mm
Fits into 10mm Hole
RAM 1500 2009 - On

UNIT PACKAGE: 25



22856

(Chrysler: 6512734AA)
Black Nylon

**Tail Lamp Mounting
Push-Type Retainer**
Head Diameter: 20mm
Stem Length: 13.4mm
Fits into 10mm Hole
Dodge Ram 2019 - On

UNIT PACKAGE: 15



20766

(6507669-AA)
Black Nylon

**Radiator Grille
Push-Type Retainer**
Head Diameter: 20mm
Stem Length: 16mm
Fits into 10mm Hole
Dodge Durango 2004 - On

UNIT PACKAGE: 25



20458

(6506132-AA)
Black Nylon

**Side Radiator Shield
Push-Type Retainer**
Head Diameter: 20mm
Stem Length: 17mm
Fits into 7mm Hole
Sebring & Stratus 2001 - On

UNIT PACKAGE: 25



17216

(GM: 21030249; Ford: N807389S,
W711035-S300; Chry: 6503598)
Black Nylon

**Air Baffle to Under Carriage
Push-Type Retainer**
Head Diameter: 20mm
Stem Length: 20mm
Fits into 8mm Hole
GM Saturn 2 Door & 4 Door Models 1991 - On;
Ford EcoSport 2018 - On; Escape, F-250, 350,
450, 550 2019 - 2017; Expedition 2018;
Explorer 2006 - On; Fiesta 2019 - 2011;
Fusion 2013 - On; Mustang 2018 -2015; Transit
2015 - On; Bronco 2021 - On;
Lincoln MKC 2019 - 2015; MKZ 2019 - 2013;
Mariner 2011 - 2007; Mountaineer 2010 - 2006,
Navigator 2019 - 2015 & Chrysler

UNIT PACKAGE: 25



20457

(4857345-AA)
Black Nylon

**Tail Light Housing
Push-Type Retainer**
Large Head
Diameter: 21mm
Stem Length: 23mm
Fits into 9.5mm Hole
Caravan Town & Country and
Voyager Mini Vans 2002 - On

UNIT PACKAGE: 25



20967

(Not Available from O.E.M.)
Black Nylon

**Rear Bumper Mounting Bracket
Push-Type Retainer**
Head Diameter: 22mm
Stem Length: 16mm
Fits into 10mm Hole
Jeep Commander 2006 - On

UNIT PACKAGE: 15



25206

(Chrysler & Mitsubishi:
MU001220, MU000695)
Black Nylon

Bumper & Apron Push-Type Retainer

Head Diameter: 20mm
Stem Length: 20mm
Fit into 8mm Hole

Chrysler Sebring, Stratus 2005;
Mitsubishi Eclipse, Galant 2012 - 2006;
Endeavor 2008 - 2006 & 2010 - 2011; Outlander 2006

UNIT PACKAGE: 25



22177

(6510766-AA)
Yellow & White Nylon

Door Panel Push-Type Retainer with Sealer

Top Head Diameter: 16mm
Middle Head Diameter: 18mm
Bottom Head Diameter: 22mm
Stem Length: 13mm
Fits into 9mm Hole

Chrysler 300, Dodge Charger &
Jeep Cherokee 2014 - On

UNIT PACKAGE: 15



21601

(6509673AA, 68185909AA)
White & Black Nylon

Push-Type Retainer with Sealer

Top Head Diameter: 16mm
Middle Head Diameter: 18mm
Bottom Head Diameter: 22mm
Stem Length: 16mm
Fits into 9mm Hole

Chrysler 200, 300 & Challenger and Dodge
Durango & Viper and Jeep Cherokee,
Grand Cherokee & Wrangler 2011 - On

UNIT PACKAGE: 15



18269

(6503106)
Black Nylon

Lower Sill Moulding Push-Type Retainer

Large Head Diameter: 7/8"
Stem Length: 1"
Fits into 1/4" Hole

Jeep Grand Cherokee Laredo 1994-On

UNIT PACKAGE: 15



21376

(4389947-AA)
Black & White Nylon

Bumper Cover Push-Type Retainer with Sealer

Head Diameter: 24mm
Shoulder Length: 3mm
Stem Length: 20mm
Fits into 11mm Hole

Avenger, Journey & Sebring 2008 - On

UNIT PACKAGE: 10



14019

(Ford: N803421-S; Chry: 6501590)
Black Nylon

Push-Type Retainer

Head Diameter: 1"
Shoulder Length: 1/8"
Stem Length: 7/8"
Fits into 5/16" Hole

UNIT PACKAGE: 25



18394

(6503453)
Black Nylon

Fascia to Bumper Push-Type Retainer

Large Head Diameter: 1"
Stem Length: 1-1/8"
Fits into 1/4" Hole

Jeep Grand Cherokee 1994 - On

UNIT PACKAGE: 25



24160

(Not Available from OEM)
Nylon

Window Lift Motor Mounting

Push-Type Retainer
Fits into 12.7mm (primary) &
9mm (secondary) Holes
Head Diameter: 25mm
Pin Length: 47mm
Pin Head: 15mm

Chrysler Mini Vans 2001 - On

UNIT PACKAGE: 25

Contains: 25-Pins & 25-Grommets



21348

(6508643-AA)
Black Nylon

Tail Light

Push-Type Retainer

Top Head Diameter: 31.5mm
Small Head Diameter: 20mm
Stem Length: 23mm
Fits into 10mm Hole
Dodge Nitro and
Jeep 2008 - On

UNIT PACKAGE: 15



20963

(4806334-AA)
Black & White Nylon

Rear Bumper Push-Type Retainer with Sealer

Head Diameter: 34mm
Shoulder Length: 3.5mm
Stem Length: 17mm
Fits into 8.5mm Hole
Dodge Caliber and
Jeep Compass &
Patriot 2007 - On

UNIT PACKAGE: 10



19638

(Chry: 4805405AA;
Ford: 1L5Z-17K826AA)
Black & White
Nylon

**Front Bumper Fascia
Push-Type Retainer**

Head Diameter: 34mm
Stem Length: 20mm
Fits into 8mm Hole
Concorde, Intrepid, Eagle
Pacifica & PT Cruiser 1998-On
Ford Trucks 2005-On

UNIT PACKAGE: 15



20890

(55157112-AA, -AB)
Black & Natural
Nylon

**Bumper Cover
Push-Type Retainer**

Head Size: 25mm x 45mm
Shoulder Length: 3mm
Stem Length: 20mm
Fits into 9.5mm Hole
Jeep Liberty 2005 - On

UNIT PACKAGE: 15



19417

(Chry: 6503819, 6503401;
GM: 25631448)
Black Nylon

M7.5 x 35mm
Square Drive Truss Head
Head Diameter: 22mm
Shoulder Diameter: 9mm
Foam to Bumper Fascia
Chrysler 1993 - On
GM 1997 - On

UNIT PACKAGE: 15



20970

(Not Available from O.E.M.)
Black Nylon

M14 x 34mm
**Bumper and Door
Insulator Nylon Screw**
Head Diameter: 22mm
No. 3 Square Drive
Fits into 12mm Hole
GM, Ford & Chrysler 2005 - On

UNIT PACKAGE: 25



21442

(68033794-AA; 68034329AA)
Black Nylon

Bumper Retainer

Head Diameter: 35mm
Stem Length: 14mm
Overall Height: 28mm
Jeep Grand Cherokee 2008 - On

UNIT PACKAGE: 15



14985

(2664040)
White Nylon

**Door Weatherstrip to
Inside Panel Clip**
Chrysler Corp. 1966-On

UNIT PACKAGE: 100



21310

(Not Available from O.E.M.)
Black Nylon

Photo not actual size

Cable Strap

Overall Length: 174mm (6-15/16")
Maximum Bundle Diameter: 40mm (1-9/16")
Strap Width: 5mm (3/16")
Chrysler 2007 - On

UNIT PACKAGE: 25



18249

(6503339)
Black Nylon

Cowl Top Stud Retainer Cover
Head Diameter: 13/16"
Dodge Ram 1994-On

UNIT PACKAGE: 25



20623

(6506306-AA)
Black Nylon

Cowl Screen Retainer
Head Diameter: 25mm
T-30 Torx® Drive
Stem Length: 14mm
Fits on to 1/4" - 20 Bolt
Dodge Dakota 1997 - On

UNIT PACKAGE: 15



14858

(3799089)

Windshield Wiper Linkage Bushing
Replaces worn wiper linkage bushing
thus eliminating wiper lag
Chrysler 1974-On

UNIT PACKAGE: 25

25184
(Chrysler: 68073375AA)
Black Nylon

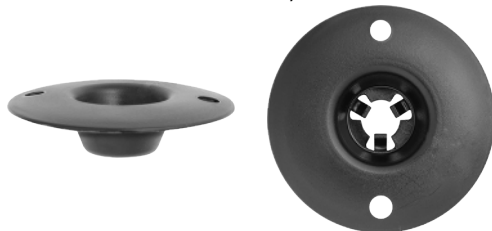

Under Body & Interior Trim Panel Push Nut
Flange O.D.: 30mm
Overall Height: 7.5mm
Fits onto 5mm Stud
Jeep Compass 2018 - On, Renegade
2017 - On; Ram ProMaster 1500, 2500,
3500, City 2015 - On

UNIT PACKAGE: 25

24584
(06505049AA)
Metal



Unthreaded Fender Moulding
Push-On Retainer
Stud Size: 5mm
Outside Diameter: 24mm
Jeep 1997 - On

UNIT PACKAGE: 50

15673
(3454220, 4658676)
Red Nylon



Door Lock Rod Clip
Used on Right-Hand Side
Rod Size: 5/32"
Chrysler 1972 - On

UNIT PACKAGE: 50

15674
(3454221, 4658677)
Green Nylon



Door Lock Rod Clip
Used on Left-Hand Side
Rod Size: 5/32"
Chrysler 1972 - On

UNIT PACKAGE: 50

10262
Nylon



Left-Hand Side



Right-Hand Side

**Door Lock Rod & Hood
Latch Locking Push Rod Clip**
Rod Size: 5/32"
Fits into 1/4" Hole
Chrysler, Ford, GM & AMC
UNIT PACKAGE: 20 Pieces
10 Rights - 10 Lefts

20675

(AMC: 4003672R;
Chry: 2945108R, 4658676;
GM: 16627328, Ford: N805350S)
White Nylon

Clip for Right-Hand Side Only

UNIT PACKAGE: 25

14967

(AMC: 4003673L;
Chry: 2945109L, 4658677;
GM: 9815325, 16607593;
Ford: D2VZ-6521952A, N804344S)
Black Nylon

Clip for Left-Hand Side Only

UNIT PACKAGE: 50

19191

(4658444)
Lavender Nylon



Door Lock Rod Clip
Right-Hand Side
Rod Size: 1/8"

Chrysler Neon, Cirrus, Stratus &
Jeep Cherokee 1995-On

UNIT PACKAGE: 25

25253

(Chrysler: 55177482AA)
Black Rubber



Floor Pan Hole Plug
Head Diameter: 45mm
Fits into 33mm Hole
Overall Height: 10mm

Dodge Caliber 2012 - 2007 Durango 2011 - On;
Jeep Cherokee 2018 - 2014, Grand Cherokee 2013 - On,
Wrangler 2006 - 2001

UNIT PACKAGE: 10

24617

(Ford N803749-S32B; GM 22520702,
15594541; Chrysler 6032268)
Metal



**Door & Quarter Panel, Center Console
& Interior Trim and Cowl Vent Cover,
Instrument Panel Retainer**
GM, Ford, Chrysler

UNIT PACKAGE: 25



22289

(GM: 11570654; Chrysler: 6509432AA
Ford: W716529-S900)
Magni-565 Blue Finish

Radiator Grille Nut

Screw Size: M4.2-1.41 (#8)
Head Size: 6mm x 16mm
Overall Height: 7mm

Buick Allure, Enclave, Encore, LaCrosse,
Lesabre, Lucerne, Rainer, Regal & Verano and
Cadillac ATS, CTS, Deville, DTS, ELR,
Escalade, SRX & STS 2000 - On
Chrysler 200, 300, PT Cruiser, Sebring, Town & Country
and Dodge Avenger, Caliber, Charger, Dart, Grand
Caravan, Ram 2500 & Ram 3500 2015 - 2006
Ford 250, 350, 450 & 550 Super Duty Trucks 2015 - 2013

UNIT PACKAGE: 25



22909

(Chrysler: 6506955AA)
Zinc Finish

Door & Fender Panel Nut

Screw Size: M6-1.0
Head Size: 14.5mm x 21mm
Stem Length: 10mm

Fits into 15mm Square Hole
Chrysler Pacifica 2017 - On
Town & Country, Dodge Caliber,
Caravan & Grand Caravan 2012 - 2005
Dodge Durango & Journey and Jeep Compass,
Grand Cherokee, Patriot & Wrangler 2017 - 2007
Dodge Ram 2009 - 2008

UNIT PACKAGE: 10



22863

(Chrysler: 6508506AA)
Zinc Organic

Door Panel Nut

Screw Size: M4.8-1.59
Head Size: 10mm x 17mm
Overall Height: 8mm

Dodge Caliber, Journey & Nitro and Jeep
Compass, Liberty & Patriot 2017 - 2007

UNIT PACKAGE: 25



25265

(Chrysler: 6510197AA)
Zinc

Radiator Grille Panel Nut

Screw Size: M4.2 (#8)
Head Size: 10.5mm x 12mm
Stem Length: 11mm

Fits into 10mm Sq. Hole
Panel Range: 2.5mm
Chrysler Pacifica 2017 - On, Voyager 2020 - On;
Dodge Durango 2021 - On; Jeep, Cherokee 2014 - On,
Compass 2017 - On, Gladiator 2020 - On,
Grand Cherokee 2015 - On, Wrangler 2018 - On

UNIT PACKAGE: 25



19310

(6034336, 6034812, 6035807)
Phosphate

Door Panel Nut

Screw Size: #6
Cirrus, Concorde, Intrepid, LHS,
Stratus & Eagle Vision 1993-On

UNIT PACKAGE: 25



21745

(GM: 11609651)
Zinc

**Windshield Garnish and Interior
Trim Moulding Fastener**

Screw Size: M4.2 (#8)
Stem Width: 13mm
Head Size: 13.5mm x 20.5mm
Overall Length: 22mm

Buick Enclave & Encore; Cadillac CTS, Escalade, STS &
XTS; Chevrolet Avalanche, Camaro, Cobalt, Corvette,
HHR, Impala, Malibu, Monte Carlo, Silverado, Suburban,
Tahoe & Traverse; Dodge Truck; Ford Flex & Taurus;
GMC Sierra & Yukon;
Kia Sorento & Soul; Pontiac G6 & G8;
Saturn Outlook and Suzuki Grand Vitara 2004 - On

UNIT PACKAGE: 15



23982

(6505223AA)
Phosphate

**Front Bumper, Door Glass &
Grille Snap in Nut**

Screw Size: M6-1.0
Hole Size: 14mm Sq.
Overall Height: 13mm
Overall Length: 16.25mm
Chrysler 300 2005 - On &
Jeep Grand Cherokee 1999 - On

UNIT PACKAGE: 10



19519

(GM: 16662182; Chry: 6502988)
Zinc Organic

**Front Bumper, Grille Mounting
& Headlight Cover Fastener**

Width: 1/2"
Height: 9/16"
Chrysler Sebring 1996 - On
GM 1993 - On

UNIT PACKAGE: 15



25275

(GM: 11589329; Chrysler: 6511238AA)
Trivalent Yellow Zinc

Pillar Trim Panel & Radiator Grille Fastener

Width: 12mm
Length: 15.5mm
'U' Width: 5mm

Buick Enclave 2020 - 2018, Encore 2020 - On, Envision
2020 - 2016, LaCrosse 2019 - 2017;
Cadillac ATS 2019 - 2015,
CT4, CT5 & XT6 2020 - On, CT6 2020 - 2016,
XT4 2019 - On, XT5 2020 - 2017; Chevrolet Blazer,
Silverado 2019 - On, Bolt 2019 - 2017,
Camaro 2020 - 2016, Colorado 2020 - 2015,
Corvette 2020 - On, Cruze 2018 - 2016,
Equinox 2020 - 2018, Express 2020 - 2019,
Impala 2020 - 2014, Sonic 2020 - 2012,
Trailblazer 2021 - On, Traverse 2020 - 2010,
Trax 2020 - 2017, Volt 2019 - 2016;
GMC Acadia 2020 - 2017, Canyon 2020 - 2015,
Savana 2020 - 2019, Sierra 2019 - On,
Terrain 2020 - 2008; Jeep Gladiator 2020 - On,
Wrangler 2018 - On

UNIT PACKAGE: 50



19339
(4676356)
Phosphate

Grille to Fascia Fastener
Width: 1/2"
Height: 23/32"
Town & Country,
Caravan and Voyager 1997-On
UNIT PACKAGE: 15



20526
(4805570-AA)
Black

**Radiator Grille
Cover Fastener**
Width: 26mm
Length: 26mm
Caravan, Town & Country
and Voyager Mini-Vans 1996 - On
UNIT PACKAGE: 10



19779
(6503812, 6504601)
Tin & Zinc

Wheel Opening Moulding Nutsert
Thread: M5 - .8
Head Diameter: 10mm
Overall Length: 12mm
Jeep 1999 - On
UNIT PACKAGE: 15



20173
(6506104AA)
Yellow Zinc

**Roof Rack Nutsert
with Sealer Under Head**
Thread: M6-1.0
Grip: .7mm - 3.2mm
Head Diameter: 17mm
Hex: 9.5mm (3/8")
Jeep 1999 - On
UNIT PACKAGE: 10



21019
(6509106-AA)
Zinc

M6-1.0 Thread Specialty
Insert with Sealer
Grip Range: .70mm - 3.17mm
Head Diameter: 17mm
Hex Size: 9.5mm
Luggage Rack & Bumper Fascia
Chrysler Jeep & Van
UNIT PACKAGE: 15



17167
(4336115)

**Door Hinge Bushing
Front & Rear Doors**
Outer Diameter: 3/8"
Inner Diameter: 1/4"
Length: 13/32"
Flange Outer Diameter: 1/2"
Aries, Caravelle, LeBaron, Reliant,
Town & Country and 600 1989-85
UNIT PACKAGE: 25



17434
(2486468)

Door Hinge Bushing
Outer Diameter: 27/64"
Inner Diameter: 11/32"
Length: 7/16"
Flange Outer Diameter: 19/32"
Chrysler Vans 1982-78

UNIT PACKAGE: 25



14552
(4033711)

Door Hinge Bushing
Outer Diameter: 5/16"
Inner Diameter: 17/64"
Length: 23/64"
Flange Outer Diameter: 33/64"
Cargo doors, lift gates, rear doors and
fold-up rear seat floor hinges
Dodge & Plymouth vans,
Ramcharger and Trailduster 1970-On

UNIT PACKAGE: 25



22062
(Not Available from O.E.M.)

Greaseable Stainless Steel
Door Hinge Roller Pin & Bushing Repair Kit
Repairs One Hinge
Dodge Ram Full Size Pick-Up 2013 - 2009
UNIT PACKAGE: 1

14561
(6500361)
Zinc



Door Hinge Pin
Length: 2-1/4"
Pin Diameter: 1/4"
Chrysler 1980-On

UNIT PACKAGE: 10



11470
(AMC: SF 400 6204;
GM: 1606642,
1618890)

1/4"-28 x 1-7/8"
**Headlight Adjusting
Screw & Nut**
AMC & Cadillac 1975-On

UNIT PACKAGE: 25



2272
(3426388)

**Front Fender and Door
Quarter Panel Moulding Fastener
Rambler**

UNIT PACKAGE: 100



14217

(GM: 1257702, 20346654;
Ford: 383207-S;
AMC: 3693099)
Nylon

Routing Clip
GM / Ford / AMC

UNIT PACKAGE: 25



Left-Hand Side

10262
Nylon
**Door Lock Rod & Hood
Latch Locking Push Rod Clip**
Rod Size: 5/32"
Fits into 1/4" Hole
Chrysler, Ford, GM & AMC

UNIT PACKAGE: 20 Pieces
10 Rights - 10 Lefts



Right-Hand Side

20675
(AMC: 4003672R;
Chry: 2945108R, 4658676;
GM: 16627328, Ford: N805350S)
White Nylon

Clip for Right-Hand Side Only

UNIT PACKAGE: 25



25220
(Chrysler: 68143484AC)
White Nylon

Sunroof Drain Tubing Clip
Holds 6mm Tubing
Head Size: 18mm x 49mm
Overall Height: 25mm
Jeep Cherokee 2014 - On

UNIT PACKAGE: 25

14967
(AMC: 4003673L;
Chry: 2945109L, 4658677;
GM: 9815325, 16607593;
Ford: D2VZ-6521952A, N804344S)
Black Nylon

Clip for Left-Hand Side Only

UNIT PACKAGE: 50



25223
(Chrysler: 4814094)
Black Nylon

Cable Clip
Holds 6mm Cable
Head Size: 8mm x 17mm
Stem Length: 11mm
Overall Height: 20mm
Fits into 6mm Hole

Chrysler 200 2017 - 2011, 300 2019 - 2005,
Cirrus 2000 - 1995, Pacifica 2017 - On,
Sebring 2010 - 1996, Voyager 2020 - On;
Dodge Avenger 2014 - 2007, Caliber 2012 -
2008, Challenger 2008 - On, Charger 2006 - On, Dart
2016 - 2013, Durango 2011 - On, Journey 2019 - 2009,
Magnum 2008 - 2005, Stratus 2006 - 1995, RAM 1500
2020 - 2009, 2500, 3500 2010; Jeep Cherokee 2014,
Commander, Compass 2010 - 2008, Grand Cherokee
2006 - On, Liberty 2007 - 2004, Patriot 2017 - 2008, Ram
1500, 2500, 3500, 4500, 5500 2011 - On

UNIT PACKAGE: 25



11697
(4000141)
Nylon

Screw Size: #6 or #8
AMC

UNIT PACKAGE: 50



20633

(Toyota: 90467-10188
Tesla: 1011813-00-A)
Turquoise Nylon

Trim Panel & Liftgate Trim Retainer

Top Head Diameter: 13mm
Middle Head Diameter: 16mm
Bottom Head Diameter: 18mm
Stem Size: 8.5mm x 9mm
Stem Length: 14mm
Overall Length: 20mm
Sienna 2004 – On
Tesla S 2012 – On; 3 2016 – On

UNIT PACKAGE: 25



20765

(Jeep: 6507055-AA,
6507686-AA
Tesla: 1016078-00-A)
Yellow Nylon

Door Panel & Trunk Trim Retainer

Top Head Diameter: 15mm
Bottom Head Diameter: 18mm
Stem Diameter: 10mm
Stem Length: 15mm
Overall Length: 23mm
Tesla S 2012 – On

UNIT PACKAGE: 50



25287

(Tesla: 1142766-00-A)
White Nylon

Headliner Retainer

Top Head Diameter: 15mm
Middle Head Diameter: 19.5mm
Bottom Head Diameter: 18mm
Stem Size: 7.5mm x 11.2mm
Stem Length: 16.5mm
Overall Length: 23mm

UNIT PACKAGE: 25



21169

(Ford: W713297-S300
Tesla: 1025401-00-A)
White Nylon

Door & Trunk Trim Panel Retainer with Sealer

Top Head Diameter: 16mm
Bottom Head Diameter: 22mm
Stem Diameter: 11mm
Stem Length: 17mm
Overall Length: 28mm

UNIT PACKAGE: 25



25153

(Tesla: 1135147-00-A, 1135147-S0-B)
Black & White Nylon

Front & Rear Door Trim Panel Retainer with Sealer

Top Head Diameter: 22mm
Middle Head Size: 15mm x 17mm
Bottom Head Diameter: 16mm
Stem Diameter: 8mm
Stem Length: 12mm
Overall Length: 29.5mm

UNIT PACKAGE: 25



25151

(Tesla: 1092696-00-B)
White Nylon

Cowl & Luggage Retainer

Top Head Diameter: 15mm
Middle Head Diameter: 15mm
Bottom Head Diameter: 15mm
Stem Diameter: 12mm
Stem Length: 9.5mm
Overall Length: 20mm

UNIT PACKAGE: 50



20349

(Toyota: 90467-08185
Nissan: 01553-09611
Tesla: 1006521-00-A)
Black Nylon

Bumper, Engine Under Cover & Hood Trim Push-Type Retainer

Head Diameter: 18mm
Stem Length: 10mm (Excluding the Pin)
Fits into 8mm Hole

UNIT PACKAGE: 15



19453

(Honda: 90505-SX0-003
Tesla: 1006535-00-A)
Black Nylon

Garnish Side Protector, Front Bumper, Wheel Apron, Engine Under Cover Push-Type Retainer

Head Diameter: 18mm
Stem Length: 15mm (Excluding the Pin)
Fits into 8mm Hole
Honda Odyssey 1995 – On
Tesla S 2016 – On

UNIT PACKAGE: 15



25112

(Tesla: 1128034-00-B)
Black Nylon

**Engine Under Cover
Push-Type Retainer**
Head Diameter: 18mm
Stem Length 16mm
Fit into 8mm Hole

UNIT PACKAGE: 25



25152

(Tesla: 1110713-99-C)
Black Nylon

**Engine Cover & Wheel Apron
Push Nut**
Stud Size: 6mm
Flange Diameter: 18mm
Overall Height: 5mm

UNIT PACKAGE: 50



25284

(Tesla: 1008245-00-A)
Zinc

**Door & Interior Trim
Panel Fastener**
Width: 10mm
Length: 11.3mm
'U' Width: 3.3mm

UNIT PACKAGE: 50



25286

(Tesla: 1115346-00-A)
Yellow Zinc

**Radiator Cover & Interior Trim
Panel Fastener**
Width: 10mm
Length: 11.3mm
'U' Width: 3.5mm

UNIT PACKAGE: 50



25285

(Tesla: 1011978-00-A)
Silver Zinc

**Rocker & Interior Trim
Panel Fastener**
Width: 11mm
Length: 16mm
'U' Width: 3.5mm

UNIT PACKAGE: 50



12119

(Tesla: 1067906-00-A)

Push-On Retainer
Stud Size: 4mm
Diameter: 11mm
Zinc Finish

UNIT PACKAGE: 100



25179

(Tesla: 1063943-00-A)

Body Panel Blind Rivet
Diameter: 6.5mm
Grip: 2mm-4.5mm
Flange Diameter: 13mm
Steel Rivet & Mandrel

UNIT PACKAGE: 15



17421

(Tesla: 1028719-00-A)

Body Panel Blind Rivet
Diameter: 3/16"
Flange Diameter: 3/8"
Grip Range: 1/16" - 17/64"
Rivet Length: 13/32"
Aluminum Rivet & Mandrel

UNIT PACKAGE: 25



22546

(Honda: 90666-SDA-A01)
White Nylon

Grille Clip

Width Across Center Ears: 9mm
Width Across Bottom Ears: 11mm
Overall Height: 16.5mm

Acura RDX, ILX, TL & TSX and Honda Accord,
Civic, CR-V, Fit, Odyssey & Pilot
2003 - On

UNIT PACKAGE: 25



21557

(75316-S9A-004)
White Nylon

Door Trim Moulding Clip

Head Size: 14mm x 16mm
Stem Length: 12mm
Fits into 10mm Hole

Acura RDX and Honda CR-V 2002 - On

UNIT PACKAGE: 25



25326

(Honda: 90666-TA0-A01)
Orange Nylon

Door & Interior Trim Panel Clip

Width: 8mm
Length: 16.5mm
'U' Width: 7.5mm

Acura ILX 2020 - 2013, RLX 2020 - 2014,
TLX 2020 - 2015, TSX 2014 - 2009;
Honda Accord 2012 - 2008, Civic 2015 - 2012,
Crosstour 2015 - 2010, Pilot 2012 - 2009

UNIT PACKAGE: 25



21639

(72431-S2X-003)
White Nylon

Moulding Clip

Top Head Size: 8mm x 10.5mm
Bottom Head Size: 11mm x 16mm
Overall Height: 14.6mm

Acura RSX and Honda Civic,
CR-Z & Insight 2006 - 01

UNIT PACKAGE: 25



21559

(91512-SJ6-J01)
Black Nylon

**Rocker Panel, Tail Light &
License Plate Housing
Garnish Moulding Clip with Sealer**

Top Head Size: 9mm x 12mm
Bottom Head Diameter: 13mm
Stem Diameter: 7.5mm
Stem Length: 9mm

Acura TSX, Honda Civic & CR-V 1997 - On

UNIT PACKAGE: 25



21772

(Honda: 76222-SPI-003)
White Nylon

**Body Side, Fender Flare,
Roof Garnish & Side Sill
Moulding Clip with Sealer**

Top Head Size: 12.5mm x 14mm
Bottom Head Diameter: 14mm
Stem Diameter: 7mm
Stem Length: 8mm

Acura Legend, MDX, RDX, RL, TL & ZDX 1991 - On
Honda Civic, Element, Odyssey & Pilot 2004 - On

UNIT PACKAGE: 25



21308

(90602-SFA-004)
White Nylon

Cowl & Dash Moulding Clip

Top Head Size: 13mm x 14mm
Bottom Head Diameter: 16mm
Stem Length: 13mm

Acura RL and Honda Civic,
Civic Hybrid & Odyssey 2005 - On

UNIT PACKAGE: 25



21555

(91512-S50-003)
White Nylon

**License Plate Garnish &
Trim Moulding Clip with Sealer**

Top Head Size: 12mm x 17mm
Bottom Head Size: 16mm x 17mm
Stem Diameter: 13mm
Stem Length: 12mm

Acura TSX & ZDX and Honda Accord, Civic,
Crosstour, Fit, Insight, Odyssey & Pilot 2001 - On

UNIT PACKAGE: 25



21558

(91504-SPI-003)
White Nylon

**Rocker Panel & Fender
Moulding Clip with Sealer**

Top Head Size: 16mm x 18mm
Bottom Head Size: 18mm x 20mm
Stem Length: 15mm
Fits into 10mm Hole

Acura Legend, MDX, RL & ZDX
and Honda Civic, CR-V & Odyssey 1991 - On

UNIT PACKAGE: 25



21204

(75315-STK-A01)
White Nylon

**Front & Rear Door Exterior Trim
Moulding Clip**

Top Head Size: 12mm x 15mm
Bottom Head Size: 14mm x 20mm
Stem Length: 9mm
RDX 2009 - 07

UNIT PACKAGE: 15



22466
(Honda: 91503-SWA-A01)
Green Nylon

Door Belt Moulding Clip
Width: 20mm
Length: 38mm
Acura MDX 2014 - On
Honda CR-V, Pilot & Ridgeline 2007 - On

UNIT PACKAGE: 25



22443
(Honda: 91513-TK8-A01)
White Nylon

Rocker, Pillars, Floor & Exterior Trim Moulding Clip with Sealer
Top Head Size: 12mm x 11mm
Bottom Head Size: 13mm x 13mm
Stem Length: 16mm
Honda Odyssey & Ridgeline 2011 - On

UNIT PACKAGE: 25



22433
(Honda: 91514-SMG-E01)
Gray Nylon

Trunk Garnish & Spoiler Moulding Clip with Sealer
Top Head Size: 12mm x 17mm
Bottom Head Size: 16mm x 17mm
Stem Length: 21mm
Acura RDX & Honda Accord, Accord Crosstour, Civic, CR-V & Pilot 2010 - On

UNIT PACKAGE: 15



22465
(Honda: 75315-TP6-A01)
White Nylon

Lower Door Garnish Moulding Clip with Sealer
Top Head Size: 12mm x 15mm
Bottom Head Size: 14mm x 30mm
Stem Length: 9mm
Acura & Honda Crosstour, Pilot & Ridgeline 2013 - On

UNIT PACKAGE: 25

22857
(Honda: 73154-T0A-003)
Green Nylon



Roof Moulding Clip
Width: 13.7mm
Length: 61.3mm
Width Across Bottom Legs: 54mm
Honda Accord 2017 - 2013
CR-V 2012 - On

UNIT PACKAGE: 25



21543
(91570-SZA-305)
Blue Nylon

Windshield Moulding Clip
Width: 8mm
Length: 82mm

Acura ZDX and Honda Odyssey & Pilot 2009 - On

UNIT PACKAGE: 5



25079
(Acura & Honda: 91570-TA5-A01)
Gray Nylon

Windshield Moulding Clip
Width: 15mm
Length: 75mm

Acura RLX 2018 - On, TLX 2015 - On, RDX 2018 - 2013; Honda Accord 2017 - 2008, CR-V 2012 - On, Crosstour 2015 - 2010

UNIT PACKAGE: 25



25066
(Acura & Honda: 91568-TA0-A00)
White Nylon

Windshield Moulding Retainer with Adhesive Strip

Width: 12mm
Length: 40mm
Overall Height: 15mm
Acura ILX 2013 - On; RLX 2014 - On; TLX 2015 - On; RDX 2019 - 2014; TL, TSX 2014 - 2009; ZDX 2013 - 2010; Honda Accord 2008 - On; Civic, CR-V 2012 - On; Clarity 2017 - On; Insight 2019 - On; Crosstour 2015 - 2010

UNIT PACKAGE: 25



19734
(90107-SX0-003)
Black Nylon

Bumper Grommet

Screw Size: #10
Head Size: 16mm x 18mm
Stem Length: 6mm
Acura 2.2CL, 2.3CL, 2.5TL, 3.2TL, 3.5RL
Honda Accord & Prelude 1996-On

UNIT PACKAGE: 15



21521

(90107-SOX-A01)
Black Nylon

Screw Grommet

Screw Size: M4.8 (#10)
Head Size: 16mm x 16mm
Stem Length: 7mm

Acura CL, MDX, RL, 3.2 CL & 3.5RI and Honda Accord, Pilot, Ridgeline & S2000 1996 - On

UNIT PACKAGE: 25



20954

(90682-SEA-003)
Black Nylon

Fender Apron Grommet

Screw Size: #8 (M4.2)
Head Diameter: 20mm
Stem Length: 12mm
Fits into 9mm Square Hole

Acura TSX and Honda Civic & Odyssey 2004 - On

UNIT PACKAGE: 25



25256

(Honda: 91561-S5P-A01)
Pink Nylon

Door Panel Screw Grommet

Screw Size: M4.2 (#8)
Head Size: 17mm x 20mm
Stem Length: 8.5mm
Overall Height: 14mm
Fits into 8.5mm Hole

Acura MDX 2020 - 2014, RDX 2012 - 2007, TL 2008 - 2004, TSX 2014 - 2009; Honda Accord 2018 - On; Civic 2001 - On; Element 2011 - 2003, Fit 2020 - 2015, Insight, Passport 2019 - On, Odyssey 2017 - 2011, Pilot 2003 - On, Ridgeline 2017 - On

UNIT PACKAGE: 25



25267

(Honda: 90601-SNV-P01)
Natural Nylon

Trunk & Liftgate Screw Grommet with Sealer

Screw Size: M5
Head Diameter: 16mm
Stem Length: 14mm
Overall Height: 18mm
Fits into 9mm Sq. Hole

Acura MDX 2014 - On, TLX 2020 - 2015, TSX 2014 - 2009; Honda Accord 2013 - On, CR-V, Civic 2012 - On, Clarity 2017 - On, Fit 2020 - 2009, HR-V, Pilot 2016 - On, Insight 2010 - On, Odyssey 2018 - On, Passport 2019 - On

UNIT PACKAGE: 25



22926

(Honda: 90601-S30-003)
White Nylon

Cowl & Wheelhouse Screw Grommet with Sealer

Head Size: 13mm x 13mm
Stem Length: 13mm
Overall Height: 14mm
Fits into 8mm x 8mm Hole

Use with Auveco 22514
Acura MDX, RDX, RL, RLX, TL, TLX, TSX & ZDX 2019 - 2001
Honda Accord, Civic, Clarity, CR-V, Fit, HR-V, Insight, Odyssey, Passport, Pilot, Prelude, Ridgeline & S2000 1997 - On

UNIT PACKAGE: 25



22547

(Honda: 91626-STK-A01)
Gray Nylon

Taillight Screw Grommet With Sealer

Head Diameter: 18mm
Stem Length: 14mm
Overall Length: 16mm

Acura MDX & RDX and Honda Accord, Civic, Crosstour & Odyssey 2007 - On

UNIT PACKAGE: 25



25055

(Acura & Honda: 91626-TA0-A01)
Blue Nylon

Tail Light Grommet with Sealer

Head Diameter: 18mm
Stem Length: 14mm
Overall Height: 15mm
Fits into 8mm Hole

Acura ILX 2013 - On; RLX 2017 - 2014; Honda Accord 2012 - 2008; Civic 2015 - 2012; HR-V 2016 - On

UNIT PACKAGE: 25



25064

(Acura & Honda: 90101-SHJ-A01)
White Nylon

Bumper Grommet

Screw Size: M4.2 (#8)
Head Size: 14mm x 28mm
Stem Length: 10mm
Fits into 8mm Slot
Overall Height: 11mm

Acura RDX 2019; TLX 2015 - On; ZDX 2013 - 2010; Honda Odyssey 2010 - 2005; Pilot 2015 - 2006

UNIT PACKAGE: 25



22365

(Honda: 90650-S5A-003)
Clear Nylon

Rear Tail Light Grommet

Head Diameter: 18.5mm
Stem Length: 24mm
Overall Length: 25mm

Acura MDX, RSX, TL, TSX 2016 - 2002
Honda Civic & Fit 2007 - 2001

UNIT PACKAGE: 25



22599

(Honda: 91548-TZ5-A02)
Dark Gray Nylon

Engine Cover Grommet

Head Size: 22mm x 14mm
Stem Size: 13.5mm x 7.6mm
Stem Length: 16mm

Acura MDX, RDX & TLX 2014 - On
Honda Odyssey, Pilot & Ridgeline 2016 - On

UNIT PACKAGE: 25

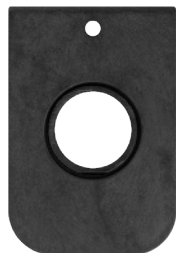

25115

(Acura & Honda: 90501-SJA-A01)
Black Nylon

**Fender & Engine Under Cover
Clip**

Width: 22mm
Length: 32mm

Hole Diameter: 9.5mm
Acura MDX, RLX 2014 - On,
RDX 2019 - On, RL 2008 -
2005, Honda Clarity, Ridgeline 2017 - On,
Odyssey 2014 - On,
Passport 2019 - On, Pilot 2016 - On



UNIT PACKAGE: 25



20472

(91512-SR3-004)
White Nylon

**Tubular Nut with
Sealer & Sealed End**

Stud Size: 3mm
Head Diameter: 8.5mm
Fits into 6mm Hole
Emblem Nut

Acura Integra and Honda Accord,
Civic, CR-V & Prelude 1994 - On

UNIT PACKAGE: 10



21773

(Honda: 91530-S0A-003)
Black Nylon

Roof Rail & Side Sill

Weatherstrip Retainer
Top Head Size: 5mm x 11mm
Bottom Head Diameter: 8mm
Stem Diameter: 6mm
Stem Length: 7mm

Acura Legend, MDX, RDX, RL, TL & ZDX 1998 - On
Honda Accord, Civic, CRV, Element
& Odyssey 2001 - On

UNIT PACKAGE: 25



22551

(Honda: 90651-TA0-003)
Natural Nylon

Door Panel & Weatherstrip Retainer

Top Head: 5mm x 12mm
Bottom Head Diameter: 12mm
Stem Diameter: 6mm
Stem Length: 4.5mm

Acura ILX, MDX, RDX, RLX & ZDX 2010 - On
Honda Accord, CR-V, Pilot, Ridgeline 2008 - On

UNIT PACKAGE: 50



21705

(Honda: 90651-TP8-003,
91568-TR0-003)
Yellow Nylon

Weatherstrip Retainer

Top Head Size: 5mm x 15mm
Bottom Head Diameter: 7.5mm
Stem Diameter: 6.5mm
Stem Length: 7mm

Acura ILX & RDX and Honda Civic & CR-V 2012 - On

UNIT PACKAGE: 25



21707

(Honda: 91563-SCV-003)
(Toyota: 67867-52010, 67867-0D060)
White Nylon

Weatherstrip Retainer

Head Size: 5mm x 15mm
Bottom Head Diameter: 6.5mm
Stem Diameter: 7mm
Stem Length: 8.5mm

Acura TL and Honda
Element Odyssey & Pilot 2003 - On
Toyota Echo, Land Cruiser, Prius, Tacoma & Yaris
and Lexus GS 450, GX 460 & LX 430 and
Scion xA & xD 2000 - On

UNIT PACKAGE: 25



21704

(Honda: 72311-S5S-003)
Green Nylon

Weatherstrip Retaining Clip

Top Head Size: 5mm x 15mm
Bottom Head Diameter: 9.5mm
Stem Diameter: 7mm
Stem Length: 11mm

Acura RDX and Honda Civic, CR-V & Fit 2003 - On

UNIT PACKAGE: 25



25065

(Acura & Honda: 90565-TZ5-003)
Black Nylon

Weatherstrip Retainer

Top Head Size: 4.7mm x 12mm
Bottom Head Diameter: 7mm
Stem Size: 4.5mm x 6.5mm
Stem Length: 7.5mm
Overall Height: 11.5mm
Fits into 5mm Hole

Acura MDX 2014 - On; Honda Accord 2018 - On; Civic,
Pilot, Ridgeline, CR-V 2016 - On; Insight,
Passport 2019 - On

UNIT PACKAGE: 25





18877
(91530-SPI-003)
Orange Nylon

Weatherstrip Retainer
Head Size: 5mm x 15mm
Stem Length: 10mm
Fits into 6mm Hole

Acura 3.5 RL and Accord, Civic & Odyssey 1992 - On

UNIT PACKAGE: 25



18114
(91520-SM4-C01)
Black Nylon

Hood Insulation Retaining Clip
Head Diameter: 10mm
Stem Length: 10mm
Panel Thickness: 4mm
Fits into 6mm Hole
Honda & Acura 1990 - On

UNIT PACKAGE: 25



18302
(GM: 20538173; Chry: 6104908-AA;
Mercedes: 002-997-33-86-67;
Honda: 91531-THR-A01)
Black Nylon

Weatherstrip Retainer
Head Diameter: 7/16"
Stem Diameter: 7/32"
Stem Length: 15/32"

Buick Century & Riviera, Chevrolet Lumina, Olds Aurora & Regency and Pontiac Grand Prix 1989 - On; Chrysler 2008 - On; Mercedes-Benz; Acura TLX 2021 - On, Honda Odyssey 2018 - On

UNIT PACKAGE: 50



19506
(90666-SA7-003ZW)
Black Nylon

Trunk Lining Retainer
Head Diameter: 16mm
Stem Diameter: 5mm Square
Stem Length: 16mm
Acura 2.5TL, 3.2TL, 3.5,
Integra & Legend and Honda Accord,
Wagon & Prelude 1987 - On

UNIT PACKAGE: 15



19467
(91501-SL4-003)
Black Nylon

Front Cowl Retaining Clip
Head Diameter: 13mm
Stem Diameter: 6mm
Stem Length: 10mm
3.5RL 1996 - On

UNIT PACKAGE: 25



19114
(91518-SM4-003)
Black Nylon

Hood & Trunk Moulding Retaining Clip
Head Diameter: 12mm
Stem Length: 9mm
Fits into 6mm Hole
Acura Integra & Honda Civic 1994 - On

UNIT PACKAGE: 10



25328
(Honda: 91532-SJA-003)
Black Nylon

Fender Garnish Molding & Hood Seal Clip
Bottom Head Diameter: 11mm
Stem Size: 5mm x 7mm
Stem Length: 10mm
Overall Height: 11mm
Acura NSX 2020 - 2017, RL 2012 - 2005,
TLX 2020 - 2018; Honda CR-V 2016 - 2012

UNIT PACKAGE: 50



22541

(Honda: 91563-TG7-A00;
Ford: W712792-S300)
Black Nylon

Weatherstrip Retainer
Head Diameter: 12mm
Stem Diameter: 8mm
Stem Length: 10mm
Acura NSX 2017 - On
Honda CR-V, Pilot & Ridgeline 2016 - On ; Ford Bronco Sport 2021 - On, Edge 2015 - On, Escape 2020 - On, Expedition 2021 - 2018, Explorer 2021 - 2020, Flex 2019 - 2009, Fusion 2020 - 2013; Lincoln Aviator 2020 - On, Continental 2020 - 2017, Corsair 2021 - 2020, MKX 2018 - 2016, MKZ 2020 - 2013, Nautilus 2020 - 2019

UNIT PACKAGE: 100



19483
(91515-SR3-000)
Black Nylon

Rear Hood Cowl Weatherstrip Retaining Clip
Head Size: 8mm x 18mm
Stem Length: 15mm
Fits into 7mm Hole
Acura Integra, Honda Civic, CR-V and Del Sol 1992 - On

UNIT PACKAGE: 25



18746
(90700-SJ4-000)
Black Nylon

Hood Insulation Retainer
Head Diameter: 30mm
Stem Diameter: 15mm x 18mm
Stem Length: 10mm
Legend 1991-On
Honda 1998-On

UNIT PACKAGE: 15



20609
(91501-SIK-003)
Black Nylon

Hood Insulation Retainer
Head Diameter: 30mm
Stem Diameter: 15mm x 20mm
Stem Length: 14mm
Acura 3.5RL & RSX and
Honda Civic & CR-V 2000 - On

UNIT PACKAGE: 25



21107
(90602-SX0-003)
White Nylon

Cowl Vent Retainer
Top Head Diameter: 12mm
Bottom Head Diameter: 16mm
Stem Diameter: 4mm
Stem Length: 13mm
Acura MDX and Honda Civic,
Insight, Odyssey & Prelude 1995 - On

UNIT PACKAGE: 10



22588
(Honda: 91547-TZ5-A02)
Black Nylon

Engine Cover Retainer
Top Head Diameter: 13mm
Bottom Head Diameter: 14mm
Stem Length: 17mm
Overall Length: 22mm
Acura MDX, RDX & TLX 2014 - On
Honda Odyssey, Pilot & Ridgeline 2016 - On

UNIT PACKAGE: 50



25069
(Acura & Honda: 91501-T2A-003)
Black Nylon

Fender Liner Retainer
Top Head Diameter: 18mm
Stem Diameter: 4.3mm
Stem Length: 15mm
Overall Height: 17mm
Acura RLX 2014 - On; Honda Accord 2013 - On; Clarity,
CR-V 2017 - On; Fit 2015 - On; HR-V 2016 - On

UNIT PACKAGE: 25



21417
(90602-TA0-003)
Blue Nylon

Cowl Vent Retainer
Top Head Size: 10mm x 14mm
Bottom Head Diameter: 16mm
Stem Diameter: 8mm
Stem Length: 13mm
Acura TSX & ZDX and Honda Accord & Fit 2008 - On

UNIT PACKAGE: 10



23978
(90602-SLJ-003, 90603-SLJ-003)
Nylon

Cowl Vent Retainer
Top Head Size: 10mm x 14mm
Bottom Head Diameter: 16mm
Stem Diameter: 8mm
Stem Length: 13mm
Acura RDX & Honda CR-V 2007 - On

UNIT PACKAGE: 10



22821
(Honda: 91512-TZ5-A01)
White Nylon

Rocker Moulding Retainer
Top Head Size: 18mm x 18mm
Bottom Head Size: 20mm x 22mm
Stem Diameter: 9.8mm
Stem Length: 22.5mm
Acura MDX & NSX 2014 - On
Honda Odyssey, Pilot & Ridgeline 2016 - On

UNIT PACKAGE: 15



19466
(91560-SZ3-003)
White Nylon

Door Trim Panel Retainer
Top Head Diameter: 13mm
Bottom Head Diameter: 17mm
Stem Diameter: 9.5mm
Stem Length: 12mm
3.5RL 1996 - On

UNIT PACKAGE: 15



19145
(91560-SP0-003)
Gray Nylon

Front & Rear Door Trim Panel Retainer
Top Head Diameter: 13mm
Bottom Head Diameter: 17mm
Stem Diameter: 9mm
Stem Length: 12mm
Overall Length: 18.5mm
Acura Integra & Legend Honda Accord, Civic,
Prelude, Odyssey & Del Sol 1991 - On

UNIT PACKAGE: 25



20411
(91560-S84-A11)
Black Nylon

Windshield Garnish Pillar Retainer
Top Head Diameter: 13mm
Middle Head Diameter: 16mm
Bottom Head Diameter: 14.5mm
Stem Diameter: 9.5mm
Stem Length: 12mm
Acura 3.2CL, Honda Accord,
Insight & Odyssey 1998-On

UNIT PACKAGE: 15



20959
(91560-S9A-A01)
Blue Nylon

Door Panel Retainer
Top Head Diameter: 13mm
Middle Head Diameter: 16mm
Bottom Head Diameter: 15mm
Stem Diameter: 9.5mm
Stem Length: 13mm
Acura TL & TSX and Honda Accord,
Civic, CR-V & Odyssey 2002 - On

UNIT PACKAGE: 25



21208
(91560-SLJ-J01)
Gray Nylon

Door Trim Panel Retainer
Top Head Diameter: 13mm
Middle Head Diameter: 16mm
Bottom Head Diameter: 18mm
Stem Diameter: 9mm
Stem Length: 12mm
Acura RDX and Honda Civic, CR-V & Pilot 2009 - On

UNIT PACKAGE: 10



25269
(Honda: 91560-TRT-J01)
Natural Nylon

Door Panel & Carpet Retainer with Sealer
Top Head Diameter: 13mm
Middle Head Diameter: 16mm
Bottom Head Diameter: 18mm
Stem Diameter: 9.5mm
Stem Length: 13mm
Overall Length: 19mm
Acura TLX 2021 - On; Honda CR-V 2019,
Clarity 2017 - On, Insight 2019 - On

UNIT PACKAGE: 25



21131
(90602-SEP-A00)
Black Nylon

Trim Panel Retainer
Top Head Diameter: 12mm
Middle Head Diameter: 16mm
Bottom Head Diameter: 18mm
Stem Diameter: 9.5mm
Stem Length: 13mm
Overall Length: 25.5mm
TL 2007 - On

UNIT PACKAGE: 15



21059
(90602-S5A-003)
Blue Nylon

Cowl Vent Retainer
Top Head Size: 12mm x 13mm
Middle Head Diameter: 16mm
Bottom Head Diameter: 18mm
Stem Diameter: 8.5mm x 8.5mm
Stem Length: 14mm
Overall Length: 21mm
Acura RSX and Honda Civic & CR-V 2001 - On

UNIT PACKAGE: 15



22469
(Honda: 90651-T3L-003)
Black Nylon

Rear Bumper Garnish Retainer
Top Head Diameter: 13mm
Middle Head Diameter: 16.5mm
Bottom Head Diameter: 18mm
Stem Diameter: 9.3mm
Stem Length: 14mm
Acura NSX & RDX 2016 - On
and Honda Accord & Civic 2017 - 2013

UNIT PACKAGE: 25



22499
(Honda: 91560-TX4-A01)
Yellow Nylon

Garnish Retainer with Sealer
Top Head Diameter: 13mm
Middle Head Diameter: 16.3mm
Bottom Head Diameter: 18mm
Stem Diameter: 9.5mm
Stem Length: 13mm
Acura ILX, MDX, RDX, RLX & TLX and Honda Civic, Clarity,
CR-V, Fit, HR-V, Odyssey, Pilot & Ridgeline 2013 - On

UNIT PACKAGE: 25



19186
(90657-SB0-003)
Black Nylon

Front Bumper Cover Push-Type Retainer
Head Diameter: 11mm
Stem Length: 10mm
Fits into 8mm Hole
Acura Legend, Honda Accord & Odyssey 1991-On

UNIT PACKAGE: 10



22199
(Honda: 90657-SA5-003)
Black Nylon

Bumper & Splash Shield Push-Type Retainer
Head Diameter: 15mm
Stem Length: 12mm
Fits into 6.3mm Hole
Acura TL 2008 - 04
Honda Accord, CR-V, Insight & Pilot 2007 - 1997

UNIT PACKAGE: 15



19232
(91502-SZ5-003)
Black Nylon

Front Fender Push-Type Retainer
Head Diameter: 17mm
Stem Length: 13mm
Fits into 7mm Hole
3.5 RL Sedan 1996-On

UNIT PACKAGE: 10



19231

(91505-SL0-003)
Black Nylon

Push-Type Retainer
Head Diameter: 18mm
Stem Length: 12mm
Fits into 8mm Hole
NSX 1991-On

UNIT PACKAGE: 15



19233

(Acura: 91503-SZ3-003)
Black Nylon

Front Bumper Push-Type Retainer
Head Diameter: 20mm
Stem Length: 13mm
Fits into 10mm Hole
Acura 3.5 RL Sedan & Honda 1996-On

UNIT PACKAGE: 15



22394

(Honda: 91561-TA0-A11,
91561-TA5-A11)
Metal & Green Nylon

Interior Trim, Pillars, Rocker Panel, Quarter Panel & Windshield Push-Type Retainer
Head Diameter: 18mm
Stem Length: 13mm
Overall Length: 38mm
Fits into 9mm Hole

Acura TL and Honda Accord, Civic, CR-Z, Fit, Odyssey, Pilot & Ridgeline 2008 - On

UNIT PACKAGE: 5



19239

(GM: 11519949;
Honda: 91512-SX0-003;
Mitsubishi: MU000319;
Lexus & Toyota: 90467-08217)
Black Nylon

Front Fender, Bumper Support, Interior Trim & Washer Tank Push-Type Retainer

Head Diameter: 20mm
Stem Length: 11mm
Fits into 8mm Hole
Acura 3.5RL, Honda Accord, Prelude & Odyssey 1994 - On; Mitsubishi Lancer 2002 - On; GM 1997 - On; Lexus GX470 2009 - 2003; Toyota 4Runner 2009 - 2003, FJ Cruiser 2014 - 2007, Tacoma 2016 - 2005

UNIT PACKAGE: 25



22112

(Honda: 91512-STK-A01)
Black Nylon

Garnish & Rear Spoiler Push-Type Retainer with Sealer
Head Diameter: 20mm
Stem Length: 13mm
Fits into 8.5mm Hole
Acura RDX & TSX and Honda Accord, CR-V & Odyssey 2011 - On

UNIT PACKAGE: 10



21706

(Honda: 91505-TM8-003)
Black Nylon

Bumper and Wheel Well Liner Push-Type Retainer
Head Diameter: 20mm
Stem Length: 14mm
Fits into 10mm Hole
Acura ILX and Honda Insight 2012 - On

UNIT PACKAGE: 15



22068

(Honda: 91513-SJK-003)
White Nylon

Rocker, Pillars, Spoiler, Garnish & Exterior Trim Push-Type Retainer with Sealer
Head Diameter: 20mm
Stem Length: 13mm
Fits into 8.5mm Hole

Acura MDX, RLX, TSX & ZDX and Honda Accord, Civic, CR-V, Element, Fit, Insight & Pilot 2007 - On

UNIT PACKAGE: 15



21173

(91506-S9A-003)
Black Nylon

Bumper & Splash Shield Push-Type Retainer with Metal Insert
Head Diameter: 20mm
Stem Length: 16mm
Fits into 10mm Hole
Acura MDX, RDX, TSX and Honda Accord, Civic CR-V & Fit 2009 - 04

UNIT PACKAGE: 10



22069

(Honda: 91512-SJK-003)
White Nylon

Rocker, Pillars, Garnish & Exterior Trim Push-Type Retainer with Sealer
Head Diameter: 20mm
Stem Length: 13mm
Fits into 8.5mm Hole

Acura ZDX 2013 - 2010
Honda Odyssey & Pilot 2005 - On

UNIT PACKAGE: 15



20564

(91503-SZ5-003)
Black Nylon

Front & Rear Bumper Push-Type Retainer
Head Diameter: 20mm
Stem Length: 18mm
Fits into 10mm Hole
Acura 3.5RL and Honda Accord & Odyssey 1996 - On

UNIT PACKAGE: 15



19140

(Acura: 90505-SL0-003;
GM: 94852368;
Mitsubishi: MB888869;
Toyota: 90467-08155)
Black Nylon

Push-Type Retainer

Head Diameter: 20mm
Stem Length: 21mm
Fits into 8mm Hole

Acura, Dodge Avenger, Eagle Talon,
Geo Prizm, Mitsubishi Eclipse & Galant and
Toyota 1993-On

UNIT PACKAGE: 5



17267

(91503-SP0-003)
Black Nylon

Front & Rear Bumper Push-Type Retainer

Head Diameter: 20mm
Stem Length: 15mm
Fits into 10mm Hole
Legend 1991 - On

UNIT PACKAGE: 15



25254

(Honda: 75891-SA7-000)
Rubber

Door Bumper

Diameter: 17mm
Overall Length: 17mm

Acura CL 2003 - 1997 ILX 2020 - 2013, Integra 2001 - 1986,
Legend 1990 - 1986, MDX 2013 - 2007, MSX 2005 - 1991,
RDX 2018 - 2007, RL 2012 - 2005, RLX 2020 - 2014, RSX
2006 - 2002, TL 2014 - 1995, TLX 2020 - 2015,
TSX 2014 - 2004, Vigor 1994 - 1992, ZDX 2013 - 2010;
Honda Accord 1986 - On, CR-V 1997 - On,
CR-Z 2016 - 2011, CRX 1991 - 1985, Civic 1984 - On,
Crosstour 2015 - 2010, Element 2011 - 2003,
Fit 2020 - 2007, HR-V 2016 - On, Insight 2010 - On;
Odyssey 2010 - 1995; Pilot 2015 - 2003,
Prelude 2001 - 1992, Ridgeline 2014 - 2006,
S2000 2009 - 2000

UNIT PACKAGE: 10



22419

(Honda: 90501-SDR-003)
Black Nylon

Rocker Moulding & Mud Guard Push-Type Retainer

Head Diameter: 20mm
Stem Length: 21mm
Fits into 10mm Hole

Acura RDX, RL & RLX and
Honda CR-V & Accord 2009 - On

UNIT PACKAGE: 25



22942

(Acura & Honda: 90111-SM4-003)
Black

Bumper Bolt

Size: M6 - 1.0 x 8mm
Shoulder Diameter: 9mm
Shoulder Length: 6.5mm
Washer Outer Diameter: 18mm
Hex: 10mm
Hex Height: 7mm

Acura CL 2003 - 1997; ILX 2019 - 2013;
Integra 2001 - 1986; Legend 1995 - 1987;
MDX 2019 - 2014; NSX 2005 - 1991; RDX 2019 - 2007;
RL 2012 - 2009; RLX 2019 - 2014; RSX 2004 - 2002;
TL 2014 - 1996; TLX 2019 - 2015; TSX 2014 - 2004;
Vigor 1994 - 1992; ZDX 2013 - 2010
Honda Accord 2020 - 1990; Civic 2020 - 1984;
CR-V 2020 - 1997; CR-Z 2016 - 2011;
Crosstour 2015 - 2010; CRX 1991 - 1984;
Element 2008 - 2007; Fit 2020 - 2007;
Insight 2020 - 2000; Odyssey 2020 - 1995;
Passport 2020 - 2019; Pilot 2020 - 2012;
Prelude 2001 - 1992; Ridgeline 2020 - 2006

UNIT PACKAGE: 15



22941

(Acura & Honda: 90101-TR0-000)
Silver

Engine Cover Phillips Drive Bolt

Size: M6 - 1.0 x 8.5mm
Shoulder Diameter: 10mm
Shoulder Length: 4.5mm
Head Diameter: 18mm

Acura ILX 2015 - 2013; Honda Civic 2015 - 2012

UNIT PACKAGE: 15



25224

(Honda: 90105-TBA-A00)
Zinc Finish

Engine Cover Phillips Drive Bolt

M6-1.0 x 15mm
Head Diameter: 18mm
Shoulder Diameter: 10mm
Shoulder Length: 2.5mm
Drive: #3 Phillips

Honda CR-V 2017 - On, Civic 2016 - On, Insight 2019 - On

UNIT PACKAGE: 15



22943

(Acura & Honda: 90674-TY2-A01)
Silver

Engine Cover Slotted Truss Head Retainer Pin

Head Diameter: 20mm
Stem Length: 13mm

Acura ILX, RLX & TLX 2014 - On
Honda Accord, Civic & CR-V 2017 - On

UNIT PACKAGE: 15



25262

(Honda: 90673-TY2-A01)
Black Phosphate

Engine Cover U-Nut

Panel Range: 3mm
Center of Hole To Edge: 15mm
Width: 20mm
Length: 32mm

Use with Auveco No. 22943
Acura ILX 2016 - On, RDX 2019 - On, RLX 2020 - 2014,
TLX 2020 - 2015; Honda Accord 2014 - On, Civic,
CR-V & Clarity 2017 - On, Insight 2019 - On

UNIT PACKAGE: 15



21170

(91591-SJ6-013)
Natural Nylon

Door Lock Rod Clip

Rod Size: 5mm
Fits into 7mm Hole
Overall Height: 17mm

Acura TSX and Honda Accord,
Odyssey & Ridgeline 2003 - On

UNIT PACKAGE: 15



25327

(Honda: 90825-T2A-003)
Black Rubber



Underbody & Fender Hole Plug

Head Size: 33.5mm
Fits into 25mm Hole
Overall Height: 7.5mm

Acura ILX, RLX 2020 - 2014, NSX 2020 - 2017,
RDX 2021 - 2015, TLX 2020 - 2015, TSX 2014; Honda
Accord, Civic, CR-V 2020 - 2013, Clarity 2021 - 2017,
Crosstour 2015 - 2014, CR-Z 2016 - 2014, Fit 2020 - 2015,
HR-V 2020 - 2016, Insight 2021 - 2013,
Odyssey 2021 - 2018

UNIT PACKAGE: 50



21388

(91558-SE3-003)
Black Nylon

**Hood Release Cable,
Fuel Door Release Cable
and Sliding Door Lock Cable Clip**

Maximum Cable Diameter: 5mm
Overall Height in Closed
Position: 17mm
Fits into 7mm Hole

Replaces Auveco 19672

Acura CL, Legend, NSX, RL, TL, TLX & Vigor and Honda
Accord, Civic, CR-V, Insight, Odyssey, Pilot, Prelude &
Ridgeline 1991 - On

UNIT PACKAGE: 25



25330

(Honda: 95550-07000)
Dark Gray Nylon



Body Hole Plug

Head Diameter: 15mm
Fits into 7mm Hole
Overall Height: 8mm

Acura CL 2003 - 1997, Integra 2001 - 1991,
Legend 1990 - 1989, MDX 2020 - 2001,
NSX 2005 - 1991, RDX 2013, RL 2012 - 2005,
RLX 2020 - 2014, RSX 2006 - 2002, TL 2007 - 1995,
TSX 2014 - 2004, Vigor 1994 - 1992;
Honda Accord 2017 - 1990, Civic 2020 - 1988,
Clarity 2021 - 2017, CR-V 2019 - 1997, CRX 1991 - 1988,
CR-Z 2016 - 2011, Element 2006 - 2003, Fit 2013 - 2007,
Insight 2014 - 2001, Odyssey 2007 - 1995,
Passport 2020 - 2019, Pilot 2007 - 2003,
Prelude 2001 - 1988, Ridgeline 2006,
S2000 2009 - 2000

UNIT PACKAGE: 50



25408

(Honda: 82871-671-000)
Black Rubber



Body Drain Hole Plug

Width: 8mm
Head Diameter: 33mm
Fits into 25mm Hole
Overall Height: 10mm
Acura RLX 2020 - 2018,
CL 2003 - 1997, ILX 2013,
Integra 2001 - 1987,
Legend 1995 - 1986,

MDX 2013 - 2001, MSX2005 - 1991,
RDX 2015 - 2007, RL 2012 - 1996,
RLX 2017 - 2014, RSX 2006 - 2002,
TL 2014 - 1995, TSX 2014 - 2004,

Vigor 1994 - 1992, ZDX 2013 - 2010;

Honda 600 1972 - 1970, Accord 207 - 1976,

Civic 2018 - 1973, Crosstour 2015 - 2011,

CR-V 2016 - 2000, CR-Z 2016 - 2011, CRX 1991 - 1984,

Del Sol 1997 - 1995, Element 2011 - 2003, Fit 2020 - 2007,

HR-V 2016 - On, Insight 2014 - 2010, Odyssey 2017 - 1995,

Pilot 2015 - 2003, Prelude 2001 - 1979,

Ridgeline 2014 - 2006, S2000 2009 - 2000

UNIT PACKAGE: 15



25068

(Acura & Honda: 90820-SNA-003)
Black Nylon

Door Hole Plug

Head Size: 29mm
Fits into 20mm Hole
Overall Height: 9.5mm

Acura ILX 2013 - On; MDX 2008 - On; RDX 2007 - On;
TLX 2015 - On; TL 2014 - 2008; ZDX 2013 - 2010;
Honda Accord 2008 - On; Civic 2006 - On;
CR-V 2007 - On; Fit, Pilot, Ridgeline 2009 - On;
HR - V 2016 - On; Insight, Passport 2019 - On;
Odyssey 2008 - On; Clarity 2018 - 2017;
Crosstour 2015 - 2010; Element 2011 - 2007

UNIT PACKAGE: 25

Photo not actual size



20380
(Not Supplied By O.E.M.)
Black Nylon

Cable Strap
Length: 200mm (8")
Maximum Bundle Diameter:
44mm (1-3/4")
Fits into 6.3mm (1/4") Hole
Import Cars

UNIT PACKAGE: 25

BMW CLIPS & FASTENERS



22861
(BMW: 51-47-8-244-458)
Yellow Nylon

Door Sill Clip
Head Size: 9mm x 12mm
Stem Diameter: 4mm x 6.5mm
Stem Length: 10mm
Fits into 6mm Hole
BMW 320i, 323i, 325i, 325xi, 328d, 328i, 328i GT, 330e,
330i, 330i GT, 330xi, 335i & 335i GT 2018 - 2001

UNIT PACKAGE: 50



25321
(BMW: 51-47-8-234-047)
Natural Nylon

Interior Trim Panel Clip
Top Head Size: 11.5mm x 15.5mm
Bottom Head Size: 11mm x 15.5mm
Stem Diameter: 11mm
Stem Length: 16mm
Overall Height: 30mm
Fits into 9.5mm Hole
BMW 318 1998 - 1992, 323 2000 - 1999, 325 2006 - 2001,
328 2000 - 1996, 330 2006 - 2001, 528 2000 - 1997,
540 2003 - 1994, 735 1992 - 1988, 740 2001 - 1993,
750 2001 - 1988, 525, 530 2003 - 2001,
M3 2006 - 2001, M5 2003 - 2000, X3 2010 - 2004

UNIT PACKAGE: 25



25320
(BMW: 51-47-1-840-961)
White Nylon

Interior Trim Panel Clip
Top Head Size: 11.5mm x 15mm
Bottom Head Size: 11mm x 14mm
Stem Diameter: 10.4mm
Stem Length: 16mm
Overall Height: 22mm
Fits into 9.5mm Hole
BMW 325 1995 - 1992, 318 1998 - 1992, 328 1998 - 1996,
M3 1999 - 1995, 323 1999 - 1998

UNIT PACKAGE: 25



23952
(51718-108-613)
White Nylon

Cowl Vent & Trunk Trim Retainer
Head Size: 11mm x 14mm
Fits into 8mm Hole
Overall Length: 14MM
BMW 3, 7 & 8 Series 1991 - On

UNIT PACKAGE: 25



23951
(51471-840-960)
White Nylon

Scuff Plate Retainer
Head Size: 9mm x 12mm
Fits into 5.7mm Hole
BMW 3, 5, Z3 & M Series 1992 - On

UNIT PACKAGE: 25



22785
(BMW: 51-13-7-269-367)
White Nylon

Lower Door Moulding Clip
Width: 18mm
Length: 41mm
Overall Height: 20mm
BMW X3 & X4 2011 - On

UNIT PACKAGE: 10



13158
(5113-1-804-205)
Nylon

**Moulding Clip
with Sealer**

UNIT PACKAGE: 50



25401
(BMW: 51-13-1-946-258)
White Nylon

Side Moulding Clip
Width: 13mm
Length: 20mm
Stem Diameter: 7mm
Stem Length: 7.5mm
Fits into 7mm Hole

BMW 525i, 535i 1995 - 1989, 540i 1995 - 1994,
M5 1993 - 1991

UNIT PACKAGE: 25



21767
(51-13-1-829-904,
51-13-6-440-146)
White Nylon

Rocker Panel Moulding Clip

Width: 21mm
Length: 28mm
Stem Length: 6.5mm
3 Series 1993 - 74
5 Series 1981 - 74

602-2002 & 2002 Ti 1975 - 67

UNIT PACKAGE: 25



21429
(51-13-1-960-054)
White Nylon with
Blue Rubber Boot

Moulding Clip
Width: 22mm
Length: 35mm
Stem Length: 11mm
BMW 1999 - 92

UNIT PACKAGE: 25



21432
(51-13-8-166-675)
White Nylon with
Blue Rubber Boot

Moulding Clip
Width: 25.5mm
Length: 34mm
Stem Length: 11mm
BMW 2003 - 1995

UNIT PACKAGE: 25



25403
(BMW: 51-13-7-291-271)
White Nylon

Roof Moulding Clip

Width: 21mm
Length: 24mm
Overall Height: 10mm
BMW 320i 2018 - 2013, 328d 2018 - 2014, 328i,
335i 2016 - 2012, 330e 2018 - 2016, 330i 2019 - 2017,
340i 2019 - 2016, 428i, 435i 2016 - 2014, 430i,
440i 2020 - 2017, ActiveHybrid 3 2015 - 2013,
M3 2018 - 2015

UNIT PACKAGE: 25



22559

(BMW: 51-71-8-259-025)
Black & White Nylon

Wheel Flare & Rocker Moulding Clip

Top Head Size: 20mm x 30mm
Grommet Head Diameter: 12mm
Grommet Stem Diameter: 7.4mm
Grommet Length: 15mm
BMW 7 Series 2001 - 1998
X Series 2011 - On

UNIT PACKAGE: 25



22140

(51717006757)
Gray Nylon

Door Seal Clip

Width: 14mm
Length: 36mm
Stem Diameter: 6mm
Stem Length: 6mm
BMW 7 Series & X5 2008 - 1998

UNIT PACKAGE: 25



22791

(BMW: 51-13-711-7-240)
Gray Nylon

**Roof Line Reveal
Moulding Clip with Sealer**

Width: 9mm
Length: 30mm
Stem Length: 11mm
Fits into 6mm Hole
BMW 320i, 328d, 330e, 330i,
340i & M3 2017 - On

UNIT PACKAGE: 25



22597

(BMW: 51-77-7-891-250)
White Nylon

Rocker Moulding Clip

Width: 20mm
Length: 32mm
Stem Diameter: 11mm
Stem Length: 18mm
BMW 3 Series 2012 - 2004

UNIT PACKAGE: 15



22141
(51717066220)
Yellow Nylon

Rocker Panel & Wheel Housing Trim Cover Clip
Width: 24mm
Length: 22mm
Stem Diameter: 6mm
Stem Length: 10mm
BMW 3, 5 & 6 Series 2004 - On

UNIT PACKAGE: 15



22142
(51717066223)
Green Nylon

Rocker Panel & Wheel Housing Trim Cover Clip
Width: 19mm
Length: 32mm
Stem Diameter: 6mm
Stem Length: 11mm
BMW 5 Series 2010 - 2002

UNIT PACKAGE: 15



25419
(BMW: 51-12-7-488-355)
Green Nylon

Rocker Moulding Clip with Sealer
Width: 36mm
Length: 44mm
Overall Height: 35mm
BMW 330 2021 - 2019, M340i 2021 - 2020

UNIT PACKAGE: 15



25400
(BMW: 51-12-7-488-356)
Blue Nylon

Rocker Moulding Clip
Width: 20.5mm
Length: 22mm
Stem Diameter: 8.5mm x 10.5mm
Stem Length: 8mm
Fits into 8.5mm Hole
BMW 330e 2021, 330i 2021 - 2019, M340i 2021 - 2020

UNIT PACKAGE: 25



25404
(BMW: 51-71-1-959-929)
White Nylon

Rocker Moulding Clip
Width: 20mm
Length: 29mm
Stem Diameter: 6mm
Stem Length: 12mm
BMW 325iX 1991 - 1988, 525i, 353i, M5 1993 - 1991

UNIT PACKAGE: 25



25399
(BMW: 51-12-7-488-348)
White Nylon

Rocker Moulding Clip
Width: 36mm
Length: 44mm
Overall Height: 34mm
BMW 330e 2021, 330i 2021 - 2019, M340i 2021 - 2020

UNIT PACKAGE: 15



22895
(BMW: 51-48-8-252-749)
White Nylon

Hood Sound Insulation Bracket Clip with Sealer
Head Diameter: 12.5mm
Stem Length: 15mm
Overall Height: 15.5mm
Fits into 8mm Hole
BMW 128i, 135i, 320i, 323Ci, 323i, 325Ci, 325i, 325xi, 328Ci, 328i, 328xi, 330Ci, 330i, 330xi, 335d, 335i, 335is, 335xi, 528i, 535i, 535i GT, 550i, 550i GT, 640i, 650i, 740i, 740iL, 750i, 750iL, 760iL, M3, M5, M6, X1 & X3 2018 - 2001

UNIT PACKAGE: 25



22202
(51131934160)
Natural Nylon

Side Moulding Grommet
Head Diameter: 10.5mm
Overall Length: 7mm
BMW 5, 7 & 8 Series 2009 - 1988

UNIT PACKAGE: 25



22892
 (BMW: 51-14-1-807-495)
 Black Nylon

Emblem Grommet
 Head Diameter: 9mm
 Stem Diameter: 6.9mm
 Stem Length: 5.5mm
 Overall Height: 7mm
 Inside Diameter: 4.5mm
 BMW 530e, 530i, 540i, 740e, 740i, 750i,
 X1, X3, X4, X5 & X6 2017 - On

UNIT PACKAGE: 30



22524
 (BMW: 51-48-8-126-849)
 Gray Nylon

Sound Insulation Grommet
 Diameter: 30mm
 Stem Diameter: 9.5mm
 Overall Height: 9mm
 BMW 8 Series 1997 - 1994
 Mini-Cooper 2014 - On

UNIT PACKAGE: 25



22084
 (07147201307;
 51757271848)
 Natural Nylon

Heat Shield Screw Grommet
 Screw Size: M4.2 (#8)
 Head Diameter: 16mm
 Stem Length: 13mm
 Overall Height: 15mm
 BMW 1, 3, 5, 6, 7 & X Series 2012 - 06

UNIT PACKAGE: 15



25405
 (BMW: 51-71-7-154-239)
 White Nylon

Trunk Lid Trim Grommet with Sealer
 Head Size: 18mm
 Stem Length: 14.5mm
 Overall Height: 16mm
 Fits into 8.5mm Hole
 Use with Auveco No. 25322
 BMW 328i, 335i 2016 - 2014, 330i, 340i 2019 - 2017, 528i,
 535i, 550i 2016 - 2011, 535d 2016 - 2014, 640i, 650i,
 M6 2019 - 2012, 840i, M8 2020 - On,
 ActiveHybrid 5 2016 - 2012, M5 2016 - 2013,
 X3 2021 - 2018, X4 2019 - On, Z4 2021 - 2019;
 Mini Cooper 2020 - 2014, Cooper Clubman 2020 - 2016,
 Cooper Countryman 2020 - 2017

UNIT PACKAGE: 25



22786
 (BMW: 07-14-6-974-274)
 Black Nylon

Liftgate Screw Grommet
 Screw Size: M3.5 (#6)
 Head Size: 9mm x 9mm
 Stem Length: 12.5mm
 Overall Length: 13mm
 Fits into 7mm Square Hole
 BMW 325xi, 328i, 328xi & X1 2016 - 2007; Mini-Cooper

UNIT PACKAGE: 50



22298
 (07-14-6-976-114)
 White Nylon

**Rear Bumper Trim Panel &
 Air Duct Mount Screw Grommet**
 Screw Size: M4.2 (#8)
 Head Diameter: 12mm
 Stem Length: 14mm
 Overall Height: 15mm
 BMW 1, 2, 3, 4, 5, 6, 7 & X Series 1983 - On

UNIT PACKAGE: 25



25398
 (BMW: 07-14-9-248-255)
 Natural Nylon

Under Cover Screw Grommet
 Head Diameter: 22mm
 Stem Length: 15mm
 Overall Height: 17mm
 Fits into 10 - 11mm Hole
 Use with Auveco No. 22509
 BMW 320i 2018 - 2013, 328d 2018 - 2014, 328i 2016 - 2012,
 330e, 340i 2018 - 2016, 330i 2019 - 2017, 335i 2015 - 2012,
 ActiveHybrid 3 2015 - 2013, M3, 2018 - 2015

UNIT PACKAGE: 25



23228
 (63171-367-868, 000-988-16-25)
 Nylon

**Cowl Vent, Fender Apron
 & Door Panel Grommet**
 Screw Size: M3.5 (#6)
 Head Size: 9.5mm x 9.5mm
 Stem Length: 14mm
 Fits into 7.2mm Hole
 BMW 3, 5, 7, Z3, M 1992 - 2002
 Mercedes CL and S Class 2000 - On

UNIT PACKAGE: 50



22952
 (BMW & Mini Cooper:
 07-14-7-265-039)
 Natural Nylon

**Door & Quarter Panel
 Screw Grommet with Sealer**
 Screw Size: M5
 Head Size: 23mm
 Stem Length: 19mm
 BMW 740e, 740i, 745e, 750i, M760i & Z4 2016 - On
 i3 2018 - 2014; Mini Cooper 2014 - On

UNIT PACKAGE: 25



22858
 (BMW: 51-12-7-461-407)
 Brown Nylon

**Bumper Support
 Screw Grommet with Sealer**
 Screw Size: M4.8 or M5
 Head Diameter: 11mm
 Stem Length: 16mm
 Overall Height: 21mm
 Fits into 8mm x 8mm Hole
 BMW X1 & X2 2017 - On
 Mini-Cooper Countryman 2017 - On

UNIT PACKAGE: 25



21499
(BMW: 51-44-7-780-135;
Mercedes-Benz: 108-988-00-27)
Natural Nylon

Tubular Nut
Stud Size: 7mm
Head Diameter: 16mm
Stem Length: 16mm
Fits into 8.5mm Hole
BMW, Mercedes-Benz & Universal

UNIT PACKAGE: 25



22790
(BMW: 51-14-8-209-932)
Natural Nylon

Emblem Grommet
Head Diameter: 7mm
Stem Diameter: 5.5mm
Inside Diameter: 3.5mm
Overall Height: 13mm
BMW 230i, 320i, 328d, 330e, 330i, 330i GT, 340i, 340i GT,
430i, 430i Gran Coupe, 440i, 440i Gran Coupe &
M2 2018 - On; Mini-Cooper

UNIT PACKAGE: 50



25322
(BMW: 51-71-7-048-316)
Black Nylon

Interior Trim Clip
Head Size: 18mm
Stem Length: 16mm
Overall Height: 17.5mm
BMW 328 2016 - 2015, 330, 340 2019 - 2017,
335 2016 - 2014, 530, 540 2020 - 2017,
535 2017 - 2010, 550 2015 - 2010,
640, 650, M6 2018 - 2012, 740, 840, M8 2020,
M5, M550, X2 2020 - 2018, M760, X6 2021 - 2020, M850,
Z4 2020 - 2019, X3 2021 - 2018, X4 2020 - 2015

UNIT PACKAGE: 25



21757
(51-48-8-181-420)
Black Nylon

Trim Panel & Trunk Lining Retainer
Head Diameter: 18mm
Stem Diameter: 9mm
Stem Length: 15mm
3 Series & 5 Series 2004 - 1988

UNIT PACKAGE: 25



22091
(51717066299)
Black Nylon

Door Sill Cover Retainer
T27 Drive
Head Diameter: 20mm
Stem Diameter: 7mm
Stem Length: 24mm
BMW 5 & 6 Series 2011 - 02

UNIT PACKAGE: 15



22782
(BMW: 51-48-9-119-216,
51-48-7-273-379)
Black Nylon

Hood Insulator Retainer
Head Diameter: 21mm
Stem Diameter: 10.8mm
Stem Length: 9.5mm
BMW 230i, 320i, 328d, 330e,
330i, 330i GT, 340i, 340i GT, 430i,
430i Gran Coupe, 440i,
440i Gran Coupe & 530e 2018 - On
Mini-Cooper & Countryman 2015 - On

UNIT PACKAGE: 50



21854
(07-14-7-122-913)
Black Nylon

Rocker Trim Wheelhouse Retainer
T10 Torx® Drive
Head Diameter: 20mm
Stem Diameter: 7mm
Stem Length: 33mm
1, 3, 6 & X Series 2004 - On

UNIT PACKAGE: 15



22509
(BMW: 07-14-7-296-886)
Black Nylon

Side Shield & Trim Retainer
Head Diameter: 24mm
Stem Diameter: 4mm
Stem Length: 23mm
T27 Drive
BMW 3 Series 2012 - On

UNIT PACKAGE: 25



25094
(BMW: 07-14-7-236-400)
Black Nylon

Liftgate Trim Clip
Top Head Diameter: 16mm
Bottom Head Diameter: 12mm
Stem Diameter: 8mm
Stem Length: 10.5mm
Fits into 8mm Hole
BMW X3 2019 - 2018, X4 2019 - On

UNIT PACKAGE: 25



22819
(Mini-Cooper: 51-46-7-453-747)
White Nylon

Exterior Grille Trim Retainer
Top Head Diameter: 10mm
Bottom Head Diameter: 12mm
Stem Diameter: 8mm
Stem Length: 9mm
Mini-Cooper, Countryman, Works & S 2013 - On

UNIT PACKAGE: 25



22789
 (BMW: 51-13-7-065-607)
 White Nylon
Liftgate Trim Retainer with Sealer
 Top Head Diameter: 10mm
 Bottom Head Diameter: 18mm
 Stem Diameter: 10mm
 Stem Length: 12mm
 BMW 325xi, 328i & 328xi 2012 - 2006
UNIT PACKAGE: 25



22862
 (BMW: 51-49-7-054-228)
 White Nylon
Trunk Trim Retainer
 Top Head Diameter: 13mm
 Bottom Head Diameter: 18mm
 Stem Diameter: 9mm
 Stem Length: 12.5mm
 BMW 325xi, 328d, 328i, 328xi, 330i, 745Li, 745i, 750Li, 750i, 760Li, 760i & X3 2017 - 2003
UNIT PACKAGE: 25



13179
 (BMW: 51-41-8-172-050;
 VW: 481-867-197)
 Black Nylon
Trim Panel Retainer
 Stem Length: 14mm
 Stem Diameter: 1mm
 Top Head Diameter: 14mm
 Bottom Head Diameter: 17mm
 VW & BMW
UNIT PACKAGE: 50



22585
 (BMW: 51-41-1-870-718)
 Green Nylon
Door Panel Retainer
 Top Head Diameter: 15mm
 Bottom Head Diameter: 18mm
 Stem Diameter: 9.5mm
 Stem Length: 12mm
 Fits into 8mm Hole
 BMW 2002, 2002tii, 318i, 320, 320i, 323i, 325e, 325i, 325is, 325ix, 524td, 525i, 528e, 528i, 530i, 533i, 535i, 535is, 540i, 630csi, 633csi, 635csi, 733i, 735i, 735il, 740i, 740iL, 745i, 750iL, M3, M5 & M6 1993 - 1969
UNIT PACKAGE: 50



22057
 (51498123832;
 51490151605; 5149810579)
 Black Nylon
Trim Panel Retainer
 Top Head Diameter: 13mm
 Bottom Head Diameter: 18mm
 Stem Diameter: 9mm
 Stem Length: 12mm
 BMW 3, 5, 6, 7, 8, X & Z Series 2012 - 1989
UNIT PACKAGE: 25



21787
 (51-77-7-171-002)
 White Nylon
Wheel Arch Cover & Footboard Retainer with Sealer
 Top Head Diameter: 12mm
 Bottom Head Diameter: 18mm
 Stem Diameter: 9.5mm
 Stem Length: 16mm
 BMW X Series 2006 - On
 Mini-Cooper S & SX Series 2011 - On
UNIT PACKAGE: 25



22498
 (Mercedes: 008-988-09-78)
 Gray Nylon
Headliner Retainer
 Top Head Diameter: 13.5mm
 Middle Head Diameter: 13.5mm
 Bottom Head Diameter: 20mm
 Stem Diameter: 9.5mm
 Stem Length: 13mm
 Mercedes-Benz Metris & Sprinter 2010 - On
UNIT PACKAGE: 15



22092
 (51717066226)
 Black Nylon
Rocker Moulding & Door Sill Spacer Cover Retainer
 Top Head Diameter: 30mm
 Bottom Head Diameter: 18.5mm
 Stem Length: 14mm
 Overall Length: 27mm
 BMW 5 & 6 Series 2011 - 02
UNIT PACKAGE: 15



22086
 (07147122912)
 Black Nylon
Rocker Panel & Wheelhouse Trim Retainer
 Top Head Diameter: 30mm
 Bottom Head Diameter: 22mm
 Stem Length: 14mm
 Overall Length: 32mm
 BMW 1, 3, 6 & X Series 2012 - 04
UNIT PACKAGE: 15



22853
 (BMW: 51-41-7-325-082)
 Black & White Nylon
Door Trim Panel Retainer With Rubber Sealer
 Top Head Diameter: 15mm
 Middle Head Diameter: 16mm
 Bottom Head Diameter: 17.5mm
 (Including Seal)
 Stem Length: 10mm
 Fits into 8mm Hole
 BMW 530e, 530i, 540i, 640i, M5, M550i & X3 2017 - On
UNIT PACKAGE: 25



20253

(BMW: 51-41-1-973-500,
Mercedes: 000-991-71-71)
White Nylon

Trim Panel Retainer

Top Head Diameter: 14mm
Middle Head Diameter: 15mm
Bottom Head Diameter: 18mm
Stem Diameter: 9mm
Stem Length: 15mm
BMW Series 3, 5 & 7 1987 - On;
Mercedes Metris 2020 - 2016;
Sprinter 1500, 2500, 3500 2010 - On

UNIT PACKAGE: 50



21788

(51-41-8-224-768,
51-41-0-407-984)
White Nylon

Door Panel Lining & Rear Window Retainer with Sealer

Top Head Diameter: 14mm
Middle Head Diameter: 15.5mm
Bottom Head Diameter: 18mm
Stem Diameter: 9.5mm
Stem Length: 14mm
Overall Length: 21mm
BMW X Series 2006 - On; Mini-Cooper 2002 - On

UNIT PACKAGE: 25



25093

(BMW: 51-71-8-234-698)
Black & White Nylon

Cowl Grille Clip with Sealer

Top Head Diameter: 12mm
Middle Head Diameter: 14mm
Bottom Head Diameter: 12.5mm
Stem Diameter: 7.5mm x 9mm
Stem Length: 14.7mm
Overall Height: 20mm
BMW 323, 328 2000 - 1999, 325, 330, M3 2006 - 2001,
X3 2017 - 2011, X4 2018 - 2015

UNIT PACKAGE: 25



21873

(51-43-7-001-491)
White Nylon

Trim Panel Retainer

Top Head Diameter: 14mm
Middle Head Diameter: 15mm
Bottom Head Diameter: 18mm
Stem Diameter: 9.5mm
Stem Length: 14mm
Overall Length: 21mm
Renault, Dacia & BMW

UNIT PACKAGE: 25



22229

(51418224781;
51410407983; 51430141025)
Gray Nylon

Door Trim Panel Retainer with Sealer

Top Head Diameter: 14.5mm
Middle Head Diameter: 15.5mm
Bottom Head Diameter: 18mm
Stem Diameter: 9.5mm
Stem Length: 14mm
BMW 1, 3, 4, 5, 6, X & Z Series 1992 - On

UNIT PACKAGE: 25



22860

(BMW: 07-14-7-443-710)
Gray Nylon

Rocker Moulding Retainer With O-Ring Seal

Top Head Diameter: 12.5mm
Middle Head Diameter: 15.5mm
Bottom Head Diameter: 18mm
Stem Diameter: 9.5mm
Stem Length: 12.5mm
BMW X1, X3 & X4 2018 - 2015

UNIT PACKAGE: 25



22793

(BMW: 07-14-7-133-419)
Beige Nylon

Door Trim Panel Retainer

Top Head Diameter: 14mm
Middle Head Diameter: 15mm
Bottom Head Diameter: 18mm
Stem Diameter: 9mm
Stem Length: 12mm
BMW 128i, 135i, 135is, 328i, X3 & X4 2011 - On

UNIT PACKAGE: 25



22090

(51477117532)
Brown Nylon

Scuff Plate Retainer with Sealer

Top Head Size: 11.6mm x 15mm
Middle Head Size: 11mm x 15mm
Bottom Head Diameter: 20mm
Stem Length: 16mm
Overall Length: 30mm
Fits into 10mm Hole
BMW 1, 3, 5, 6 & X Series 2012 - 02

UNIT PACKAGE: 15



22792

(BMW: 51-13-7-269-358)
White Nylon

Lower Door Moulding Clip

Top Head Size: 12mm x 14mm
Bottom Head Size: 13mm x 16mm
Stem Diameter: 9.5 x 11mm
Stem Length: 12mm
Fits into 10mm Hole
BMW X3 2017 - 2011, X4 2015 - On

UNIT PACKAGE: 15



21780
(51-47-8-166-992)
Black Nylon

Trunk Lid Compartment Trim & Wheel Well Push-Type Retainer

Head Diameter: 9mm
Stem Length: 7mm
Fits into 5mm Hole
3, 5, & M Series 1993 - On

UNIT PACKAGE: 25



21779
(51-46-7-002-606)
Black Nylon

Front Bumper, Grille, Trunk Panel & Rear Window Push-Type Retainer

Head Diameter: 10mm
Stem Length: 11mm
Fits into 6.3mm Hole
3, 5, 7 & Z Series 1997 - On

UNIT PACKAGE: 25



23902
(51711-928-946)
Nylon

Drive Type Cowl Vent Push-Type Retainer

Head Size: 10mm x 12mm
Fits into 6mm Hole
BMW 5 & 7 Series

UNIT PACKAGE: 25



22303
(51-16-8-197-908)
Black Nylon

Upper Cover & Spoiler Push-Type Retainer

Head Diameter: 12mm
Stem Length: 13mm
Fits into 7mm Hole

BMW 1, 3, M3 & Z4 and Mini-Cooper Base, John Cooper Works, Countryman & Paceman 2013 - On

UNIT PACKAGE: 15



22859
(BMW: 16-13-6-753-087)
Black Nylon

Cowl Grille & Fuel Tank Strap Push-Type Retainer

Head Diameter: 15mm
Stem Length: 8mm
Fits into 6.3mm Hole

BMW 320i, 328d, 328i, 328i GT, 330e, 330i, 330i GT, 335i, 335i GT, 340i, 340i GT, 428i, 428i Gran Coupe, 430i, 430i Gran Coupe, 435i, 440i & 440i Gran Coupe 2012 - On; Mini-Cooper 2015 - 2007

UNIT PACKAGE: 25



25319
(BMW: 51-13-1-885-399)
Black Nylon

Grille & Interior Trim Push-Type Retainer

Head Diameter: 7mm x 15mm
Stem Length: 14.5mm
Stem Diameter: 5.7mm x 7.7mm
Fit into 6mm Sq. Primary & 7mm Secondary Hole
Panel Range: 7mm

BMW 525 2007 - 2001, 528 2010 - 2008, 530 2007 - 2001, 535 2010 - 2008, 540 2003 - 1994, 545, 645 2005 - 2004, 550, 650, M6 2010 - 2006, 735 1992 - 1988, 740 2001 - 1993, 750 2001 - 1988, M5 2010 - 2000, X5 2006 - 2000, Z3 2002 - 1996

UNIT PACKAGE: 25



22596
(BMW: 17-11-1-712-963)
Black Nylon

Bumper Side Support & Fan Shroud Push-Type Retainer

Head Diameter: 15mm
Stem Length: 11mm
Fits into 8mm Hole

BMW 3, 5, 7, 8, X, Z Series & i8 1990 - On
Mini-Cooper 2010 - 2007

UNIT PACKAGE: 25



22201
(51498166702)

Trim Panel Push-Type Retainer

Head Diameter: 12.5mm
Stem Length: 12mm
Fits into 8.5mm Hole
BMW 1, 2, 3, 5, 6, 7, X & Z Series
1995 - On

UNIT PACKAGE: 15



21645
(Not Available from O.E.M.)
Black Nylon

Bumper & Wheel Opening Push-Type Retainer

Head Diameter: 15mm
Stem Length: 15mm
Fits into 6.3mm Hole
BMW 2004 - On

UNIT PACKAGE: 15



20234
(BMW: 51-11-1-908-077;
Mercedes: 000-990-54-92)
Black Nylon

Bumper, Grille, Scuff Plate & Trim Push-Type Retainer

Head Diameter: 15mm
Stem Length: 15mm
Fits into 6.3mm Hole
BMW Series 3, 5 & 7 1984 - On
Mercedes-Benz 2014 - 1994

UNIT PACKAGE: 50



22401

(BMW: 51-11-1-964-186)
Black Nylon

Bumper Cover Push-Type Retainer

Head Diameter: 15mm
Stem Length: 20mm
Fits into 6mm Hole

BMW 3, 5, 7, X, Z Series 2010 - 1983

UNIT PACKAGE: 25



22893

(BMW: 51-48-1-915-964)
Black Nylon

Hood Insulator & Rear Bumper Push-Type Retainer

Head Diameter: 20mm
Stem Diameter: 6.8mm
Stem Length: 11mm
Fits into 7mm Hole

BMW 128i, 135i, 135is, 318i, 318is, 323i, 323is, 325Ci, 325i, 325is, 325xi, 328Ci, 328i, 328is, 328xi, 330Ci, 330i, 330xi, 335d, 335i, 335is, 335xi, 525i, 525xi, 528i, 530i, 530xi, 535i, 535xi, 540i, 545i, 550i, 645Ci, 650i, 735iL, 740i, 740iL, 750iL, M3, M5, M6, X3, X4, X5, X6, Z3, Z4 & Z8 2017 - 1991
Mini-Cooper, Countryman & Paceman 2016 - 2011

UNIT PACKAGE: 50



22894

(BMW: 07-14-7-401-727)
Black Nylon

Interior Trim Panel Push-Type Retainer

Head Diameter: 20mm
Stem Diameter: 7.8mm
Stem Length: 13mm
Fits into 8mm Hole

BMW 228i 2016 - 2014
230i, M2, M235i, M240i & X3 2017 - On
320i, 320iX, 328d, 328dX, 328i, 328iX, 330e, 335i, 335iX, 340i, 340iX, 530e, 530eX, 530i, 540dX, 540i, 640iX, 740eX, 750i, B7 & M3 2019 - 2011, 330i, 330iX, 540iX, 740i, 740iX, 745eX, 750iX, 840i, 840iX, M5, M550iX, M760iX, M8, M850iX, X1, X2, X4, X5, X6, X7 & Z4 2015 - On
Mini-Cooper & Countryman 2017 - On

UNIT PACKAGE: 25



22855

(BMW: 51-49-8-237-075)
Dark Gray Nylon

Trunk Lid, Quarter Trim & Control Module Push-Type Retainer

Head Diameter: 15.5mm
Stem Length: 13mm
Fits into 8mm Hole

BMW 128i, 135i, 323i, 325Ci, 325i, 325xi, 328i, 328xi, 330Ci, 330i, 330xi, 335d, 335i, 335is, 335xi, M3, X3, & X4 2018 - 1999; Mini-Cooper 2007 - On

UNIT PACKAGE: 25



22781

(BMW: 07-14-7-213-303)
Natural Nylon

Rocker Moulding Push-Type Retainer

Head Diameter: 18mm
Stem Length: 9mm
Fits into 8mm Hole

BMW 530e, 530i, 540i, 640i, 640i Gran Coupe, 650i, 650i Gran Coupe, 740e, 740i, 750i & M6 2018 - On

UNIT PACKAGE: 25



25420

(BMW: 51-71-8-195-811)
Black Nylon

Cowl Vent Push-Type Retainer

Head Diameter: 11mm x 18mm
Stem Length: 13.5mm
Stem Diameter: 9mm
Fit into 8mm Hole

Panel Range: 4mm Max
BMW 740, 750 2001 - 1995, X4 2018 - 2015

UNIT PACKAGE: 25



20638

(BMW: 51471911992,
51470146782, 51470390017)
Mercedes-Benz: 201-990-02-92)
Black Nylon

Push-Type Retainer

Head Diameter: 20mm
Stem Length: 14mm
Fits into 8.5mm Hole

BMW 1, 2, 3, 4, 5, 6, 7, i3, i8, X & Z Series 1988 - On; Mercedes-Benz

UNIT PACKAGE: 25



22848

(BMW: 07-14-7-281-961)
Black Nylon

Rocker Moulding Push-Type Retainer

Head Diameter: 25mm
Stem Length: 19mm
Fits into 8mm Hole

BMW X3 2017 - 2011
X4 2015 - On

UNIT PACKAGE: 25



25031

(Mercedes
230-990-00-92-9C75)
Black Nylon

**Hinge Cover
Push-Type Retainer**
Head Diameter: 20mm
Stem Length: 21mm
Stem Diameter: 9mm
Fits into 8.5mm Hole

Mercedes-Benz A220, CLS 450, CLS53 AMG, G550, G63 AMG, Sprinter 1500 2019 - On; B250e 2017 - 2015; C230 2007 - 2003; C240, C320 2005 - 2001; C280, ML500 2007 - 2006; C300, C63 AMG 2009 - 2008; C32 AMG 2004 - 2002; C350, CLK350 2009 - 2006; C55 AMG 2006 - 2005; CL550, C600 2014 - 2007; CL63, CL65 AMG 2014 - 2008; CLA250, CLA45 AMG 2014 - On; CLK320 2005 - 2003; CLK500, CLK55 AMG, E500, E55 AMG 2006 - 2003; CLK550, GL320 2009 - 2007; CLK63 AMG 2008 - 2007; E300, GLC300, GLS450, GLS550, GLS63 AMG, SL450, SLC300, SLC43 AMG 2019 - 2017; E320 2009 - 2003; E350 2016 - 2006; E400 2018 - 2015; E43 AMG 2018 - 2017; E450, E53 AMG, GLC43 AMG, GLE43 AMG 2019; E550, S550, S600 2017 - 2007; E63 AMG, S65 AMG 2019 - 2007; GL350 2016 - 2010; GL450 2016 - 2007; GL550 2016 - 2008; GL63 AMG 2016 - 2013; GLA250, GLA45 AMG 2015 - On; GLC63 AMG, S450, S560 2019 - 2018; GLE300d 2017 - 2016; GLE350, GLE550e 2018 - 2016; GLE400, GLE63 AMG, Metris 2019 - 2016; GLE450 AMG 2016; GLS350d 2017; ML320 2009 - 2007; ML350 2011 - 2006; ML450 2011 - 2010; ML550 2011 - 2008; ML63 AMG 2011 - 2007; S350 2013 - 2012; S400 2013 - 2010; S63 AMG 2019 - 2008; SL400 2016 - 2015; SL550, SL63 AMG 2019 - 2013; SL65 AMG 2018 - 2013; SLK250 2015 - 2012; SLK280 2008 - 2006; SLK300 2016 - 2009; SLK350, SLK55 AMG 2016 - 2005; Sprinter 2500, 3500 2010 - On

UNIT PACKAGE: 25



20388

(51218-205-295)
Black Nylon

Cowl Vent Push-Type Retainer
Head Diameter: 20mm
Stem Length: 16mm
Fits into 7mm Hole
Series 5 1997 - On

UNIT PACKAGE: 50



20270

(51-48-1-915-464, 51-48-1-938-725)
Black Nylon

**Hood & Trunk Insulation
Push-Type Retainer**
Head Diameter: 20mm
Stem Length: 9mm
Fits into 7mm Hole
Series 3, 5 & 7 2001 - 84

UNIT PACKAGE: 25



20734

(51-11-1-944-537)
Black Nylon

**Bumper, Wheel Opening, Scuff Plate &
Interior Trim Push-Type Retainer**
Head Diameter: 20mm
Stem Length: 15mm
Fits into 6.3mm Hole
Series 3, 5, 7 & X5 1989 - On

UNIT PACKAGE: 50



20248

(51-11-8-174-185)
Black Nylon

**Bumper Trim
Push-Type Retainer**
Head Diameter: 20mm
Stem Length: 17mm
Fits into 6.3mm Hole
Series 3, 5 & 7 1995 - On

UNIT PACKAGE: 25



22052

(51471919209)
Black Nylon

**Interior Trim & Engine
Intake Duct Push-Type Retainer**
Head Diameter: 20mm
Stem Length: 17mm
Fits into 6.3mm Hole
BMW 3, 5, 7, 8, X and Z Series 2012 - 1984

UNIT PACKAGE: 25



21778

(51-12-7-004-445)
Black Nylon

**Rear Bumper Support Fixture Trim
Push-Type Retainer**
Head Diameter: 20mm
Stem Length: 21mm
Fits into 8.5mm Hole
3, 5 & 6 Series 2002 - On

UNIT PACKAGE: 25



22854

(BMW: 61-13-8-350-827)
White Nylon

Tubing Support Clip
Width: 10mm
Length: 19mm
Height: 18mm
Leg Width: 13.5mm
Leg Length: 15mm
BMW 2008 - On

UNIT PACKAGE: 25



25252

(BMW: 51-71-8-218-852)
Black Dacromet

Phillips Drive Engine Under Cover Fastener

Head Diameter: 18mm
Stem Diameter: 7mm
Stem Length: 21.5mm
BMW 525i, 530i 2003 - 2001,
528i 2000 - 1996, 540i 2003 - 1996, 740i,
750i 2001 - 1995, M5 2003 - 2000

UNIT PACKAGE: 10



25406

(BMW: 72-11-1-917-406 & 72-11-1-950-829)
Black Nylon

Seat Belt Stop Button

Diameter: 16mm
2 Piece Set

BMW 1 Series M 2011, 128i, 135i, 2013 - 2008, 228i,
M235i 2021 - 2020 & 2016 - 2014, 230i, M240i 2021 - 2017,
320i 2018 - 2013, 323Ci 2001 - 2000, 325i, 325xi,
330xi 2006, 328d 2018 - 2014, 328xi, 335xi,
Alpina B7 2008 - 2007, 330Ci 2006 - 2001, 330e,
M2 2021 - 2016, 330i 2021 - 2006, 335d 2011 - 2010, 335i,
328i 2016 - 2007, 335is 2013 - 2011, 340i 2019 - 2016,
428i, 435i, 535d 2016 - 2014, 430i 2017 - On,
440i 2020 - 2017, 525i 2007 - 2001, 525xi,
530xi 2007 - 2006, 528i 2016 - 1997, 528xi, 535xi 2008,
530e 2020 - 2018, 530i 2017 - On, 2007 - 2001,
535i 2017 - 2008, 540d 2018,
540i 2017 - On & 2003 - 1997, 545i, 645Ci 2005 - 2004,
550i 2017 - 2006, 640i 2019 - 2012, 650i, M6 2019 - 2006,
740e 2019 - 2017, 740i 2011 - On & 2001 - 1995,
740iL, 750iL 2001 - 1995, 740Ld 2015, 740Li 2015 - 2011,
745i, 745Li 2005 - 2002, 750i 2020 - 2006,
750Li 2015 - 2006, 760i 2006 - 2004, 760Li 2015 - 2003,
ActiveHybrid 3, ActiveHybrid 7, 2015 - 2013,
ActiveHybrid 5 2016 - 2012, i8 2020 - 2014,
M3 2018 - 2001, M340i 2021 - 2020, M4 2021 - 2015,
M5 2000 - On, M550i 2021 - 2018, M760i 2022 - 2017,
X1 2021 - 2013, X3 2021 - 2004, X4 2015 - On,
X5 2018 - 2000, X6 2019 - 2008, Z3 2002 - 1999,
Z4 2008 - 2003

UNIT PACKAGE: 25



21431

(BMW: 16-13-1-176-747;
Mercedes-Benz: 003-990-02-51)
Black Nylon

Nylon Flange Nut

Stud Size: 5mm
Hex: 10mm
Flange Diameter: 16mm
Overall Height: 11mm
BMW & Mercedes-Benz 1997 - On

UNIT PACKAGE: 25



22783

(BMW: 51-16-1-943-122)
Black Nylon

Splash Shield & Filler Tube Nut

Screw Size: M4.8 (#10)
Hex Size: 10mm
Flange Diameter: 18mm
BMW 535i GT, 550i GT, 640i, 640i, 640i; Gran Coupe,
650i, 650i Gran Coupe M6, X4 & X5 2017 - On

UNIT PACKAGE: 25



22787

(BMW: 07-14-7-336-362)
Black Nylon

Fender Liner & Wheel Apron Nut

Screw Size: M4.8-1.61 (#10)
Hex Size: 10mm
Flange Diameter: 18mm
BMW X3, X4, i3 & i3s 2011 - On

UNIT PACKAGE: 25



22784

(BMW: 51-71-7-154-520)

Trim Panel Screw Grommet

Screw Size: M4.2 (#8)
Head Size: 9.5mm x 9.5mm
Stem Length: 11mm
Fits into 7mm Square Hole
BMW 530e, 530i & 540i 2017 - On
X1, X5 & X6 2015 - On

UNIT PACKAGE: 50



22788

(BMW: 51-12-7-046-911)
White Nylon

Bumper Screw Grommet with Sealer

Screw Size: M4.2 (#8)
Head Diameter: 15mm
Stem Length: 19mm
Fits into 8mm Square Hole
BMW 528i, 640i, 640i Gran Coupe, 650i,
650i Gran Coupe, M6 & M6 Gran Coupe 2016 - On
Mini-Cooper Countryman & Paceman 2016 - 2011

UNIT PACKAGE: 25



22087

(51711958025)
Black Nylon

Heater & Air Conditioning Duct Nylon Nut

Screw Size: M4.8 (#10)
Hex Size: 10mm
Flange Diameter: 24mm
Overall Height: 10.3mm
BMW 1, 3, 5, 7, X & Z Series 2012 - 1986

UNIT PACKAGE: 25



22780

(BMW: 07-14-7-169-847,
07-14-7-166-870;
Mercedes: 002-990-53-50)
Black Nylon

**Fender Liner, Wheel Apron
& Rocker Moulding Nut**

Screw Size: M4.8-1.61 (#10)
Hex Size: 10mm

Flange Diameter: 22mm

BMW 230i, 320i, 328d, 330e, 330i, 330i GT, 340i, 340i GT,
430i, 430i Gran Coupe, 440i, 440i Gran Coupe &
M2 2018 - On; Mini-Cooper, Clubman,
Countryman & Paceman 2011 - On; Mercedes CL550,
CL600 2014 - 2007, CL63 AMG, CL65 AMG 2014 - 2008;
G550, G63 AMG, Sprinter 1500, 2500,
3500 2019 - On; S350 2013 - 2012;
S400 2013 - 2010; S550, S600 2013 - 2007;
S63 AMG, S65 AMG 2013 - 2008

UNIT PACKAGE: 25



25396

(BMW: 07-14-7-154-227)
Zinc

Fender Apron Hex Flange Nut

Thread Size: M4.8-1.61

Flange O.D.: 16mm x 19mm

Hex Size: 8mm

Height: 10mm

BMW 323Ci 2000, 323i 2000-1999, 325Ci, 325i, 325x
330Ci, 330i, 330xi 2006-2001, 328xi, 335i,
335xi 2008-2007, 328i 2008-2007, 2000-1999,
M3 2011-2001, XI 2015-2013

UNIT PACKAGE: 25



25264

(BMW: 07-14-6-949-380)
Zinc

Body Flanged Hex Nut

Thread Size: M4.8-1.61

Flange O.D.: 30mm

Hex Size: 10mm

Height: 7mm

BMW & Mini Cooper 1984 - On

UNIT PACKAGE: 25



22109

(51437194187)
Yellow Zinc

Trim Retaining Clip

Width: 13mm

Overall Height: 15mm

BMW 3, 5, 7, 8, X & Z Series 2012 - 1986

UNIT PACKAGE: 25



25318

(BMW: 51-11-7-071-270)
Zinc

Bumper Cover Spacer

Width: 17mm

Length: 18mm

Height: 3.5mm

BMW 1 Series 2011, 325 2006, 335 2011 - 2007,
328 2012 - 2007, 128, 135, M3 2013 - 2008, XI 2015 - 2013,
X5 2013 -2010, X6 2014 - 2008, Z4 2016-2009

UNIT PACKAGE: 25



25342

(BMW: 07-14-6-951-655)
Finish: Silver Zinc

Metric U-Nut

Screw Size: M4.2-1.41 (#8)

Panel Range: 0.8mm Max

Center of Hole To Edge: 9mm

Width: 15mm

Length: 18mm

Bumper

BMW 1 Series M 2011, 128, 135 2013 - 2008, 325, 330 2006,
328 2013 - 2007, 335 2011 - 2007, 535 2017 - 2010,
550 2015 - 2010, 640, 650, M6 2019 - 2012, i3 2020 - 2014,
M3 2018 - 2008, M4 2020 - 2015, XI 2015 - 2013,
X3 2021 -2007, X4 2020 - 2008, X6 2021 - 2008,
X7 2020 - 2019, Z4 2016-2009

UNIT PACKAGE: 25



23852

(000-994-04-05)
Yellow Zinc

Screw Size: M4.2-1.41 (#8)

Length: 16mm

Width: 11.2mm

Panel Range: 0.5mm - 1.7mm

Center of Hole to Edge: 8mm

UNIT PACKAGE: 50



13223

(BMW:0712-9-925-708;
Mercedes: 000-994-25-45)
Plated

U-Type Nut

Screw Size: 4.2mm (#8)

Panel Range: 3mm -4mm

Center of Hole to Edge: 7mm

UNIT PACKAGE: 50



13216

Zinc

U-Type Nut
Screw Size: 4.8mm (#10)
Panel Range: .9mm - 2mm
Center of Hole to Edge: 8mm

UNIT PACKAGE: 25

WARNING: Reproductive Harm & Cancer
www.P65Warnings.ca.gov



13218

(BMW: 0712-9-925-737;
Mercedes: 000-994-06-45)
Plated

U-Type Nut
Screw Size: 4.8mm (#10)
Panel Range: .5mm-1.7mm
Center of Hole to Edge: 7mm

UNIT PACKAGE: 50

WARNING: Reproductive Harm & Cancer
www.P65Warnings.ca.gov



13215

(Mercedes: 000-994-14-45)
Plated

U-Type Nut
Screw Size: 4.8mm (#10)
Panel Range: .8mm -1.7mm
Center of Hole to Edge: 11mm
BMW & Mercedes

UNIT PACKAGE: 50

WARNING: Reproductive Harm & Cancer
www.P65Warnings.ca.gov



22114

(07129904150)
Zinc Finish

U-Type Nut
Screw Size: M4.8 (#10)
Panel Range: 2.3mm - 3.5mm (.090"-.138")
Center of Hole to Edge: 8.5mm
BMW 2011 - 1992

UNIT PACKAGE: 25



22822

(BMW: 07-14-7-212-877)
Yellow Nylon

Bumper Cover U-Nut
Screw Size: M5
Panel Range: 2.5mm Max.
Center of Hole to Edge: 8mm
BMW 535i GT, 550i GT, 640i, 640i
Gran Coupe, 650i, 650i Gran Coupe,
740e, 740i, 750i, M6 & X6 2017 - On

UNIT PACKAGE: 25



13162

(0712-9-925-720)
Plated

U-Type Nut
Screw Size: 5.6mm
Panel Range: 1.2mm - 2.0mm
Center of Hole to Edge: 10mm
UNIT PACKAGE: 50

WARNING: Reproductive Harm & Cancer
www.P65Warnings.ca.gov



22113

(BMW: 51127070202;
VW: N90168602)
Zinc Finish

Metric Extruded U-Nut
Screw Size: M5-8
Panel Range: .45mm - 1.5mm
Center of Hole to Edge: 11.5mm
BMW 1999 - 1992
VW 1993 - On

UNIT PACKAGE: 25



22847

(BMW: 07-14-7-311-312)
Natural Nylon

Rocker & Fender Moulding U-Nut
Screw Size: M4.2 (#8)
Width: 15mm
Length: 22mm
Height: 13.5mm
Panel Range: 1mm
Center of Hole to Edge: 11mm
BMW 428i, 428i Gran Coupe, 430i, 430i Gran Coupe,
435i, 435i Gran Coupe, 440i, 440i Gran Coupe,
528i, 530e, 530i, 535d, 535i, 535i GT,
540i, 550i, 550i GT, 640i, 640i Gran Coupe,
650i, 650i Gran Coupe, 740Ld, 740Li, 740i,
750Li, 750i, 760Li, Active Hybrid 5 & 7, M4, M5,
M550i, M6, M6 Gran Coupe, M760i, X1, X2, X3,
X5, X6, i3, i3s & i8 2012 - On
Mini Cooper, Clubman & Countryman 2014 - On

UNIT PACKAGE: 25



22131

(7147391324)
White Nylon

Wheel Arch Trim Cover Nylon Rivet
Diameter: 6mm
Grip Range: 1.5mm - 10mm
Flange Diameter: 20mm
BMW X5 2013 - On

UNIT PACKAGE: 25

BMW AND FIAT CLIPS & FASTENERS



22147
(51777171004)
Black Nylon

Wheel Arch Trim Cover Nylon Rivet
Diameter: 6mm
Grip Range: 1.5mm - 10mm
Flange Diameter: 20mm
BMW X3, X4, X5 & X6 Series 2006 - On

UNIT PACKAGE: 25



22146
(07147293278)
Black Nylon

Wheel Arch Trim Cover Nylon Rivet
Diameter: 6mm
Grip Range: 2.5mm - 10.75mm
Flange Diameter: 20mm
BMW X3, X4 & X5 Series 2010 - On

UNIT PACKAGE: 25

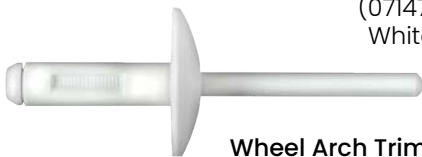

22144
(07147391323)
White Nylon

Wheel Arch Trim Cover Nylon Rivet
Diameter: 6mm
Grip Range: 2.5mm - 10.75mm
Flange Diameter: 20mm
BMW X3, X4 & X5 Series 2010 - On

UNIT PACKAGE: 25



22917
(BMW: 07-14-7-378-241)
White Nylon

Air duct Nylon Rivet
Diameter: 6mm
Grip Range: 3.0mm - 8.0mm
Flange Diameter: 12.5mm
BMW 4, 5 & M Series 2018 - 2015
740i, 750i & M760i 2020 - On

UNIT PACKAGE: 25

FIAT CLIPS & FASTENERS



22432
(Chrysler: 68093998-AA; Fiat: 71728806;
Citroen & Peugeot: 856543)
White Nylon

Body Side Moulding Clip with Sealer
Top Head Size: 11mm x 12mm
Bottom Head Size: 15mm x 19mm (Including the Sealer)
Stem Diameter: 10.3mm
Stem Length: 13mm
Fiat, Citroen, Peugeot, Chrysler
Postal Minivan Vehicles & Dodge Ram Promaster 2014 - On

UNIT PACKAGE: 25



17195

(Isuzu: 8942180270)
Black Nylon

Grille Clip

Width: 13mm

Length: 22mm

Ford Escort, Honda, Isuzu,
Mitsubishi & Plymouth Laser

UNIT PACKAGE: 25



20331

(90108-SS0-003)
Black Nylon

Bumper Clip

Screw Size: #8

Width: 35mm

Height: 38mm

Accord 1998 - On

UNIT PACKAGE: 5



18457

(91578-SV4-003)
Nylon

Radiator Grille Clip

Accord 1994-On

UNIT PACKAGE: 5



20677

(71598-S30-013)
Black Nylon

**Rear Bumper
Moulding Clip with Sealer**

Width: 3mm

Length: 30mm

Overall Height: 31mm

Accord 1998 - On

UNIT PACKAGE: 5



21836

(91578-TOA-003)
Yellow Nylon

Bumper Moulding Clip

Head Size: 19mm x 24mm

Stem Length: 15mm

Overall Length: 40mm

Honda CRV 2012 - On

UNIT PACKAGE: 15



25067

(Honda: 90650-T2A-003)
Blue Nylon

Tail Lamp Retainer with Sealer

Width: 23.5mm

Length: 30mm

Stem Size: 15mm Sq.

Stem Length: 12mm

Fits into 15mm Sq. Hole

Honda Accord 2017 - 2013;

Clarity 2017 - On

UNIT PACKAGE: 15



19439

(90116-S82-A01)
Nylon

Left Rear Bumper Fascia Clip

Accord 1998-On

UNIT PACKAGE: 5



22262

(90617-TBA-A01)

Cowl Moulding Clip

Top Head Size: 18mm x 19mm

Stem Diameter: 6.6mm

Stem Length: 13mm

Honda Civic 2016 - On

UNIT PACKAGE: 25



20603

(71592-S5D-000)
White Nylon

**Bumper Retainer
with Sealer**

Head Size:

20mm x 23mm x 15mm

Stem Length: 22mm

2001 - On

UNIT PACKAGE: 15



15997

(34355-SD2-003)
Nylon

Side Marker Clip

Accord 1986 - On

UNIT PACKAGE: 25



22546

(Honda: 90666-SDA-A01)
White Nylon

Grille Clip

Width Across Center Ears: 9mm
Width Across Bottom Ears: 11mm
Overall Height: 16.5mm
Acura RDX, ILX, TL & TSX and Honda Accord,
Civic, CR-V, Fit, Odyssey & Pilot 2003 - On

UNIT PACKAGE: 25



22242

(90601-SMG-003)
Yellow Nylon

Front Bumper, Fender, Exterior Trim & Quarter Panel Moulding Clip

Width at Bottom: 14mm
Overall Height: 17.5mm
Honda CR-V, HR-V & Pilot 2012 - On

UNIT PACKAGE: 25



25326

(Honda: 90666-TA0-A01)
Orange Nylon

Door & Interior Trim Panel Clip

Width: 8mm
Length: 16.5mm
'U' Width: 7.5mm
Acura ILX 2020 - 2013, RLX 2020 - 2014,
TLX 2020 - 2015, TSX 2014 - 2009;
Honda Accord 2012 - 2008, Civic 2015 - 2012,
Crosstour 2015 - 2010, Pilot 2012 - 2009

UNIT PACKAGE: 25



21186

(75305-SHJ-003)
White Nylon

Front and Side Door Exterior Trim Moulding Clip

Width: 13mm
Length: 14mm
Height: 13mm
Odyssey 2005 - On

UNIT PACKAGE: 15



25063

(Honda: 33152-TLA-A01)
Black Nylon

Head Lamp Moulding Clip

Width: 7mm
Length: 20mm
Overall Height: 17mm
Honda CR-V 2017 - On

UNIT PACKAGE: 25



21207

(91513-SMG-E11)
White Nylon

Fender Moulding Clip

Top Head Size: 7mm x 7mm
Bottom Head Size: 10mm x 19mm
Stem Length: 6mm
CR-V 2009 - On

UNIT PACKAGE: 25



22241

(91513-SMG-E01)
White Nylon

Wheel Arch Garnish Moulding Clip with Sealer

Top Head Size: 7mm x 7mm
Bottom Head Size: 10mm x 19.5mm
Stem Length: 6mm
Honda CR-V 2007 - On
Honda Pilot 2016 - On

UNIT PACKAGE: 25



22467

(Honda: 91213-SZA-A01)
Gray Nylon

Pillar Garnish Clip

Top Head Size: 7mm x 7mm
Bottom Head Size: 10mm x 19mm
Stem Length: 6mm
Honda Civic, Odyssey
& Pilot 2009 - On

UNIT PACKAGE: 25



17443

(91534-SE0-000)
Nylon

Body Side Moulding Clip

Accord 1986 - On

UNIT PACKAGE: 25



21470

(75306-SZA-A01)
White Nylon

Moulding Clip

Top Head Size: 7.5mm x 10mm
Bottom Head Size: 9.5mm
Overall Height: 16mm
Pilot 2009 - On

UNIT PACKAGE: 15



21557
(75316-S9A-004)
White Nylon

Door Trim Moulding Clip
Head Size: 14mm x 16mm
Stem Length: 12mm
Fits into 10mm Hole
Acura RDX and Honda CR-V 2002 - On

UNIT PACKAGE: 25



21559
(91512-SJ6-J01)
Black Nylon

Rocker Panel, Tail Light & License Plate Housing Garnish Moulding Clip with Sealer
Top Head Size: 9mm x 12mm
Bottom Head Diameter: 13mm
Stem Diameter: 7.5mm
Stem Length: 9mm
Acura TSX and Honda Civic & CR-V 1997 - On

UNIT PACKAGE: 25



22463
(Honda: 91513-T0A-A01)
Black Nylon

Wheel Well Arch Protective Liner Moulding Clip with Sealer
Top Head Size: 10mm x 10mm
Bottom Head Size: 10mm x 19mm
Stem Length: 11.5mm
Honda CR-V 2012 - On

UNIT PACKAGE: 25



22464
(Honda: 75316-TP6-A01)
White Nylon

Lower Door Garnish Moulding Clip with Sealer
Top Head Size: 10mm x 12mm
Bottom Head Size: 16mm x 21mm
Stem Length: 9mm
Fits into 10mm Hole
Honda Crosstour, Pilot & Ridgeline 2013 - On

UNIT PACKAGE: 25



20602
(75306-SV1-A01)
White Nylon

Body Side Moulding Clip
Head Size: 14mm x 14mm
Stem Length: 14mm
Accord 1998 - On

UNIT PACKAGE: 25



22465
(Honda: 75315-TP6-A01)
White Nylon

Lower Door Garnish Moulding Clip with Sealer
Top Head Size: 12mm x 15mm
Bottom Head Size: 14mm x 30mm
Stem Length: 9mm
Acura & Honda Crosstour, Pilot & Ridgeline 2013 - On

UNIT PACKAGE: 25



21639
(72431-S2X-003)
White Nylon

Moulding Clip
Top Head Size: 8mm x 10.5mm
Bottom Head Size: 11mm x 16mm
Overall Height: 14.6mm
Acura RSX and Honda Civic, CR-Z & Insight 2006 - 01

UNIT PACKAGE: 25



20783
(75305-S0A-003)
White Nylon

Body Side Moulding Clip
Head Size: 6.5mm & 13mm x 18mm
Stem Length: 12mm
Civic, CR-V, Odyssey & Pilot 1999 - On

UNIT PACKAGE: 10



20785
(75305-SH4-003)
Red Nylon

Body Side Moulding Clip
Head Size: 14mm x 15mm
Stem Length: 14mm
Civic 1996 - On

UNIT PACKAGE: 10



20784
(75305-SH2-003)
Blue Nylon

Body Side Moulding Clip
Head Size: 12mm x 15mm
Stem Length: 15mm
Civic & CR-V 1996 - On

UNIT PACKAGE: 10



21109
(75329-SH4-013)
Red Nylon

Door Moulding Clip
Head Size: 10mm x 12mm
Stem Length: 13mm
Accord 1990 - On

UNIT PACKAGE: 15



22560
(Honda: 90602-SJK-003)
Black Nylon

Cowl Vent Retaining Clip
Top Head Size: 14mm x 16mm
Bottom Head Diameter: 16mm
Stem Size: 8mm x 10mm
Stem Length: 13mm
Honda Accord, Civic &
CR-V 2015 - 2005

UNIT PACKAGE: 10



21772
(76222-SPI-003)
White Nylon

Body Side, Fender Flare, Roof Garnish & Side Sill Moulding Clip with Sealer
Top Head Size: 12.5mm x 14mm
Bottom Head Diameter: 14mm
Stem Diameter: 7mm
Stem Length: 8mm

Acura Legend, MDX, RDX, RL, TL & ZDX 1991 - On
Honda Civic, Element, Odyssey & Pilot 2004 - On

UNIT PACKAGE: 25



22130
(Not Available from O.E.M.)
White Nylon

Body Side Moulding Clip
Head Size: 14.5mm x 20mm
Stem Length: 14mm
Fits into 8mm Hole
Honda CR-V 2012 - On

UNIT PACKAGE: 25



21555
(91512-S50-003)
White Nylon

License Plate Garnish & Trim Moulding Clip with Sealer
Top Head Size: 12mm x 17mm
Bottom Head Size: 16mm x 17mm
Stem Diameter: 13mm
Stem Length: 12mm
Acura TSX & ZDX and Honda Accord, Civic, Crosstour, Fit, Insight, Odyssey & Pilot 2001 - On

UNIT PACKAGE: 25



22283
(91514-SAA-003)
White Nylon

Rocker Panel Moulding Clip with Sealer
Top Head Size: 18mm x 16mm
Bottom Head Size: 22mm x 20mm
Overall Height: 19mm
Honda Fit 2013 - 2007

UNIT PACKAGE: 15



22468
(Honda: 91514-SYP-003)
White Nylon

Upper Side Sill Garnish Clip with Sealer
Top Head Size: 18mm x 16mm
Bottom Head Size: 22mm x 20mm
Stem Length: 7mm
Honda Fit & Fit EV 2014 - 2009

UNIT PACKAGE: 25



21419
(91503-S3Y-003)
White Nylon

Rocker, Pillars, Floor & Exterior Trim Moulding Clip with Sealer
Top Head Size: 11mm x 13mm
Bottom Head Size: 15.5mm x 19mm
Stem Diameter: 12mm
Stem Length: 19mm
Insight 2006 - On

UNIT PACKAGE: 10



21558
(91504-SPI-003)
White Nylon

Rocker Panel & Fender Moulding Clip with Sealer
Top Head Size: 16mm x 18mm
Bottom Head Size: 18mm x 20mm
Stem Length: 15mm
Fits into 10mm Hole
Acura Legend, MDX, RL & ZDX and Honda Civic, CR-V & Odyssey 1991 - On

UNIT PACKAGE: 25



22443
(Honda: 91513-TK8-A01)
White Nylon

Rocker, Pillars, Floor & Exterior Trim Moulding Clip with Sealer
Top Head Size: 12mm x 11mm
Bottom Head Size: 13mm x 13mm
Stem Length: 16mm
Honda Odyssey & Ridgeline 2011 - On

UNIT PACKAGE: 25



22433

(Honda: 91514-SMG-E01)
Gray Nylon

**Trunk Garnish & Spoiler
Moulding Clip with Sealer**

Top Head Size: 12mm x 17mm
Bottom Head Size: 16mm x 17mm
Stem Length: 21mm

Acura RDX & Honda Accord, Accord Crosstour,
Civic, CR-V & Pilot 2010 - On

UNIT PACKAGE: 15



22821

(Honda: 91512-TZ5-A01)
White Nylon

Rocker Moulding Retainer

Top Head Size: 18mm x 18mm
Bottom Head Size: 20mm x 22mm
Stem Diameter: 9.8mm
Stem Length: 22.5mm

Acura MDX & NSX 2014 - On
Honda Odyssey, Pilot
& Ridgeline 2016 - On

UNIT PACKAGE: 15



21216

(91502-S9A-003)
White Nylon

**Front & Rear Bumper
Moulding Clip with Sealer**

Head Size: 14mm x 26mm
Stem Length: 15mm
Height: 28mm

CR-V 2002 - On

UNIT PACKAGE: 10



21796

(91503-T2A-A01)
Pink Nylon

Belt Moulding Clip

Width: 20mm
Length: 29mm

Honda Accord 2013 - On

UNIT PACKAGE: 25



25329

(Honda: 91503-TR0-A01)
Dark Blue Nylon

Door Moulding Clip

Width: 20mm
Length: 36mm
Overall Height: 12mm
Honda Civic 2015 - 2012

UNIT PACKAGE: 25



25255

(Honda: 91503-TLY-H01)
Yellow Nylon

Belt Moulding Clip

Width: 20mm
Length: 31mm
Overall Height: 12.5mm
Honda CR-V 2019

UNIT PACKAGE: 25



22587

(Honda: 91503-TK8-A01)
White Nylon

Door Belt Moulding Clip

Width: 20mm
Length: 37mm
Honda Odyssey
2017 - 2011

UNIT PACKAGE: 50



22466

(Honda: 91503-SWA-A01)
Green Nylon

Door Belt Moulding Clip

Width: 20mm
Length: 38mm
Acura MDX 2014 - On
Honda CR-V, Pilot &
Ridgeline 2007 - On

UNIT PACKAGE: 25



17442

(90601-SH3-014)
Nylon

Door Belt Moulding Clip

Civic 1988-On

UNIT PACKAGE: 10



23901

(91562-S84-A01)
Yellow Nylon

Belt Moulding Clip

Size: 20mm x 27mm
Honda Accord 1998

UNIT PACKAGE: 10

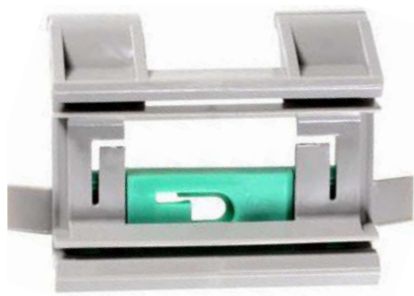

21597
(91519-SCV-A01)
Gray and
Green Nylon

Moulding Clip
Element 2003 - On

UNIT PACKAGE: 10

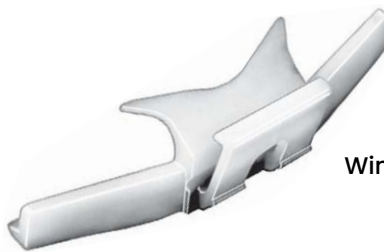

18866
(91528-SS0-003)
White Nylon

Windshield Moulding Clip
Prelude 1992 - On

UNIT PACKAGE: 15



19359
(91531-ST0-003)
Nylon

Door Moulding Clip
Civic 2, 3 & 4 Door
1995 - On

UNIT PACKAGE: 10



21095
(91570-SDA-A01)
Blue Nylon

Windshield Moulding Clip
Width: 15mm
Length: 76mm
Accord 2003 - On

UNIT PACKAGE: 10



19415
(91527-SM4-003, 91527-SZ3-003,
91561-S84-A01)
White Nylon

Belt Moulding Clip
Accord & Odyssey
1990 - On

UNIT PACKAGE: 10

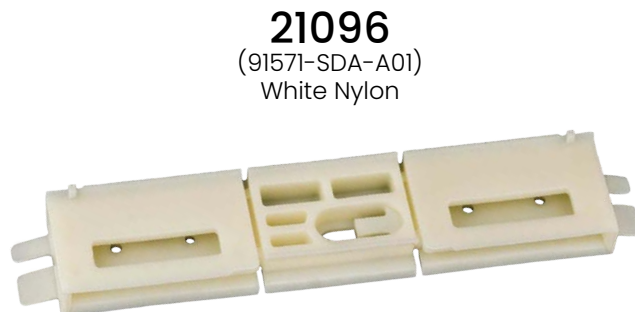

21096
(91571-SDA-A01)
White Nylon

Windshield Moulding Clip
Width: 16mm
Length: 75mm
Accord 2003 - On

UNIT PACKAGE: 10



17096
(91513-SM4-000)
Nylon

Rocker Panel Moulding Clip
Width: 20mm
Length: 20mm
Fits into 12mm Hole
Accord 1991 - On

UNIT PACKAGE: 10



21543
(91570-SZA-305)
Blue Nylon

Windshield Moulding Clip
Width: 8mm
Length: 82mm
Acura ZDX and Honda Odyssey & Pilot 2009 - On

UNIT PACKAGE: 5



22704
(Honda: 91561-TV1-E11)
White & Black Nylon

Windshield & Interior Trim Moulding Clip
Overall Height: 43mm
Overall Width: 18mm x 22mm
Honda Accord, CR-V, Fit &
Pilot 2015 - On

UNIT PACKAGE: 5

25079

(Acura & Honda: 91570-TA5-A01)
Gray Nylon



Windshield Moulding Clip

Width: 15mm
Length: 75mm

Acura RLX 2018 - On, TLX 2015 - On, RDX 2018 - 2013;
Honda Accord 2017 - 2008, CR-V 2012 - On,
Crosstour 2015 - 2010

UNIT PACKAGE: 25

22273

(73154-TA0-A01)
Blue Nylon



Windshield Moulding Clip

Width: 16mm
Length: 61.3mm

Width across Bottom Legs: 54mm
Honda Accord 2012 - 2008

UNIT PACKAGE: 15

20387

(91519-S5A-003)
Black Nylon



Windshield Moulding Clip

Width: 17mm
Length: 50mm

Upper Area of Windshield
Civic Coupe 2001 - On

UNIT PACKAGE: 10

23555

(91572-SV4-003)
Pink Nylon



Windshield Moulding Side Clip

Honda Accord 1994 - On

UNIT PACKAGE: 10

22857

(Honda: 73154-T0A-003)
Green Nylon



Roof Moulding Clip

Width: 13.7mm
Length: 61.3mm

Width Across Bottom Legs: 54mm
Honda Accord 2017 - 2013
CR-V 2012 - On

UNIT PACKAGE: 25

20386

(91520-S5A-003)
White Nylon

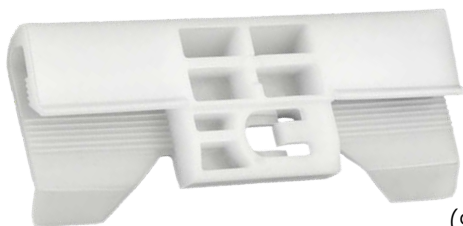

Windshield Moulding Clip

Width: 23mm
Length: 63mm

Lower Area of Windshield
Civic Sedan 2001 - On

UNIT PACKAGE: 10

21094

(91572-SDA-A01)
White Nylon



Windshield Moulding Clip

Width: 14mm
Length: 62mm
Accord 2003 - On
Civic 2006 - On

UNIT PACKAGE: 10

14705

(90713-SB0-003)
Black Nylon



Quarter Window Moulding Clip

Width: 18mm
Length: 18mm

Snaps into 5mm Hole

UNIT PACKAGE: 25

14703

(90673-SC6-003)
White Nylon



Windshield Moulding Clip

Width: 14mm
Length: 35mm

UNIT PACKAGE: 25



19115
(91528-S01-A01)
Blue Nylon

Drip Moulding Clip
4 Door Civic 1995 - On

UNIT PACKAGE: 15



22165
(73156-T0A-003)
Brown Nylon

Drip Moulding Clip
Length: 61mm
Honda CR-V 2012 - On

UNIT PACKAGE: 25

25066
(Acura & Honda: 91568-TA0-A00)
White Nylon



**Windshield Moulding Retainer
with Adhesive Strip**

Width: 12mm
Length: 40mm

Overall Height: 15mm

Acura ILX 2013 - On; RLX 2014 - On; TLX 2015 - On;
RDX 2019 - 2014; TL, TSX 2014 - 2009;
ZDX 2013 - 2010; Honda Accord 2008 - On; Civic,
CR-V 2012 - On; Clarity 2017 - On; Insight 2019 - On;
Crosstour 2015 - 2010

UNIT PACKAGE: 25



23790
Nylon

Wheelhouse Fender Grommet

Screw Size: M4.2 (#8)
Head Diameter: 11mm
Stem Length: 10mm
Fits into 5mm Hole
Honda Accord 1986 - On

UNIT PACKAGE 25



14288
(90655-SA0-003)
Natural Nylon

Screw Size: #6
Width: 9.5mm
Length: 9.5mm
Snaps into 6mm x 6mm Hole

UNIT PACKAGE: 50



14317
(34301-692A-0000)
White Nylon

Screw Size: #8
Width: 9.5mm
Length: 9.5mm
Snaps into 6mm x 6mm Hole

UNIT PACKAGE: 50



14255
(Honda: 75522-611-000;
Mazda: 9991-00-412;
Mitsubishi: MS-480001)
Black Nylon

Screw Size: #8
Width: 9.5mm
Length: 9.5mm
Snaps into 7mm x 7mm Hole

UNIT PACKAGE: 50



20350

(90866-SA0-000)
Natural Nylon

Door Trim Nylon Nut
Screw Size: #4
Head Size: 13mm x 13mm
Stem Length: 7mm
Civic 1998 - On

UNIT PACKAGE: 25



20351

(90666-SD9-000)
Natural Nylon

Nylon Nut
Screw Size: #14 (M6.3)
Head Size: 16mm x 16mm
Stem Length: 8mm
CR-V 1997 - On

UNIT PACKAGE: 25



17058

(90676-SA7-003)
Natural Nylon

Headlight Adjusting Screw Nut
Screw Size: M5-.8
Prelude & Accord 1986 - On

UNIT PACKAGE: 25



14287

(90656-671-6310M1)
Natural Nylon

Screw Size: #14 (1/4")
Width: 13mm
Length: 15mm
Snaps into 8.5mm x 10.5mm Hole

UNIT PACKAGE: 50



14274

(Honda: 75521-611-000;
Mazda: 9991-00-601;
Nissan: 96706-P0105
Toyota: 90189-06010)
Natural Nylon

Screw Size: #10
Width: 13mm
Length: 13mm
Snaps into 8.5mm x 8.5mm Hole

UNIT PACKAGE: 25



19117

(91619-SM4-003,
91619-SM4-0030)
Natural Nylon

**Center Pillar Garnish
Moulding (Oval) Screw Grommet**
Screw Size: #4
Odyssey & Accord Wagon 1991 - On

UNIT PACKAGE: 25



14313

(Honda: 90662-671-003;
Mazda: 9991-00-503;
Nissan: 62698-V7000, 68425-H5000)
Natural Nylon

Screw Size: #10
Width: 17mm
Length: 17mm
Snaps into 8mm x 8.5mm Hole
Also for Mazda & Nissan

UNIT PACKAGE: 25



14690

(Honda: 90683-693-000;
Nissan: 78856-R4301)
White Nylon

Screw Grommet
Screw Size: #10
Width: 12mm
Length: 19mm
Stem Length: 17mm
Fits into 8mm x 15mm Hole

UNIT PACKAGE: 25



19646

(90665-SM4-000)
Yellow Nylon

**Front Door
Screw Grommet**
Screw Size: #6
Head Diameter: 14mm
Stem Length: 10mm
Fits into 7mm x 7mm Hole
Prelude 1997 - On

UNIT PACKAGE: 15



14268

(Honda: 90672-671-8110M1;
Toyota: 90189-04013)
White Nylon

Screw Grommet
Screw Size: #6
Head Diameter: 14mm
Stem Length: 15mm
Fits into 7mm x 7mm Hole

UNIT PACKAGE: 25



14281

(Honda: 90662-693-003;
Toyota: 90189-04066)
White Nylon

Screw Grommet
Screw Size: #6
Head Diameter: 14mm
Stem Length: 10mm
Fits into 7mm x 7mm Hole

UNIT PACKAGE: 25



19741

(90670-SG0-003, 91626-SH3-003)
Natural Nylon

Door Panel Screw Grommet
Screw Size: #8 (M4.2)
Head Diameter: 12mm
Stem Length: 16mm
Fits into 7mm x 7mm Hole
Civic & CR-V 1993 - On

UNIT PACKAGE: 15



14695

(Honda: 90661-SC7-003;
Mazda: H001-50-841;
Mitsubishi: MS-480012;
Nissan: 01651-00481, 74798-S9000;
Toyota: 90189-06042)
White Nylon

Screw Grommet
Screw Size: #8 (M4.2)
Head Diameter: 16mm
Stem Length: 17mm
Fits into 8mm x 8mm Hole

UNIT PACKAGE: 25



20303
(90664-SB3-003)
Natural Nylon

Trim Panel Screw Grommet
Screw Size: #8 (M4.2)
Head Diameter: 15mm
Stem Length: 15mm
Fits into 8mm x 8mm Hole
Accord 1998 - On

UNIT PACKAGE: 10



20954
(90682-SEA-003)
Black Nylon

Fender Apron Screw Grommet
Screw Size: #8 (M4.2)
Head Diameter: 20mm
Stem Length: 12mm
Fits into 9mm Square Hole
Acura TSX and Honda Civic &
Odyssey 2004 - On

UNIT PACKAGE: 25



21205
(90682-SDA-A01)
Black Nylon

Rear Bumper Screw Grommet
Screw Size: M4.8 (#10)
Head Size: 14mm x 14mm
Stem Length: 14mm
Civic 2009 - On

UNIT PACKAGE: 15



21521
(90107-S0X-A01)
Black Nylon

Screw Grommet
Screw Size: M4.8 (#10)
Head Size: 16mm x 16mm
Stem Length: 7mm
Acura CL, MDX, RL, 3.2 CL & 3.5RI and Honda Accord,
Pilot, Ridgeline & S2000 1996 - On

UNIT PACKAGE: 25



19650
(90106-SW3-003)
White Nylon

Bumper Grommet
Head Size: 18mm x 20mm
Stem Length: 19mm
Fits into 8mm x 11mm Hole
Use with Auveco 19470
Accord, Odyssey & Prelude 1995 - On

UNIT PACKAGE: 10



25256
(Honda: 91561-S5P-A01)
Pink Nylon

Door Panel Screw Grommet
Screw Size: M4.2 (#8)
Head Size: 17mm x 20mm
Stem Length: 8.5mm
Overall Height: 14mm
Fits into 8.5mm Hole

Acura MDX 2020 - 2014, RDX 2012 - 2007,
TL 2008 - 2004, TSX 2014 - 2009;
Honda Accord 2018 - On; Civic 2001 - On;
Element 2011 - 2003, Fit 2020 - 2015, Insight,
Passport 2019 - On, Odyssey 2017 - 2011, Pilot 2003 - On,
Ridgeline 2017- On

UNIT PACKAGE: 25



18415
(71144-SR3-A00)
Natural Nylon

Bumper Grommet
Screw Size: M4.2 (#8)
Civic 1993 - On

UNIT PACKAGE: 25



19533
(90107-S10-003)
Black Nylon

**Wheel Well Moulding
Screw Grommet**
Screw Size: #10
CR-V 1997 - On

UNIT PACKAGE: 25



25267
(Honda: 90601-SNV-P01)
Natural Nylon

**Trunk & Liftgate Screw Grommet with
Sealer**
Screw Size: M5
Head Diameter: 16mm
Stem Length: 14mm
Overall Height: 18mm
Fits into 9mm Sq. Hole
Acura MDX 2014 - On, TLX 2020 - 2015, TSX
2014 - 2009; Honda Accord 2013 - On,
CR-V, Civic 2012 - On, Clarity 2017 - On,
Fit 2020 - 2009, HR-V, Pilot 2016 - On,
Insight 2010 - On, Odyssey 2018 - On,
Passport 2019 - On

UNIT PACKAGE: 25



22926

(Honda: 90601-S30-003)
White Nylon

**Cowl & Wheelhouse
Screw Grommet with Sealer**

Head Size: 13mm x 13mm
Stem Length: 13mm
Overall Height: 14mm
Fits into 8mm x 8mm Hole
Use with Auveco 22514
Acura MDX, RDX, RL, RLX, TL,
TLX, TSX & ZDX 2019 - 2001
Honda Accord, Civic, Clarity, CR-V, Fit,
HR-V, Insight, Odyssey, Passport, Pilot,
Prelude, Ridgeline & S2000 1997 - On

UNIT PACKAGE: 25



22547

(Honda: 91626-STK-A01)
Gray Nylon

Taillight Screw Grommet With Sealer

Head Diameter: 18mm
Stem Length: 14mm
Overall Length: 16mm
Acura MDX & RDX and Honda Accord,
Civic, Crosstour & Odyssey 2007 - On

UNIT PACKAGE: 25



25055

(Acura & Honda: 91626-TA0-A01)
Blue Nylon

Tail Light Grommet with Sealer

Head Diameter: 18mm
Stem Length: 14mm
Overall Height: 15mm
Fits into 8mm Hole
Acura ILX 2013 - On; RLX 2017 - 2014;
Honda Accord 2012 - 2008;
Civic 2015 - 2012; HR-V 2016 - On

UNIT PACKAGE: 25



25064

(Acura & Honda: 90101-SHJ-A01)
White Nylon

Bumper Grommet

Screw Size: M4.2 (#8)
Head Size: 14mm x 28mm
Stem Length: 10mm
Fits into 8mm Slot
Overall Height: 11mm
Acura RDX 2019;
TLX 2015 - On; ZDX 2013 - 2010;
Honda Odyssey 2010 - 2005; Pilot 2015 - 2006

UNIT PACKAGE: 25



22365

(Honda: 90650-S5A-003)
Clear Nylon

Rear Tail Light Grommet

Head Diameter: 18.5mm
Stem Length: 24mm
Overall Length: 25mm
Acura MDX, RSX, TL, TSX 2016 - 2002
Honda Civic & Fit 2007 - 2001

UNIT PACKAGE: 25



22599

(Honda: 91548-TZ5-A02)
Dark Gray Nylon

Engine Cover Grommet

Head Size: 22mm x 14mm
Stem Size: 13.5mm x 7.6mm
Stem Length: 16mm
Acura MDX, RDX & TLX 2014 - On
Honda Odyssey, Pilot & Ridgeline 2016 - On

UNIT PACKAGE: 25



25115

(Acura & Honda: 90501-SJA-A01)
Black Nylon

**Fender & Engine Under Cover
Clip**

Width: 22mm
Length: 32mm
Hole Diameter: 9.5mm
Acura MDX, RLX 2014 - On,
RDX 2019 - On, RL 2008 - 2005,
Honda Clarity, Ridgeline 2017 - On,
Odyssey 2014 - On,
Passport 2019 - On, Pilot 2016 - On

UNIT PACKAGE: 25



20472

(91512-SR3-004)
White Nylon

Tubular Nut with Sealer & Sealed End

Stud Size: 3mm
Head Diameter: 8.5mm
Emblem Nut
Fits into 6mm Hole
Acura Integra, Honda Accord, Civic,
CR-V & Prelude 1994 - On

UNIT PACKAGE: 10



18115

(90676-SR4-003)
Nylon

Reveal Moulding Pin Retainer

Civic 1993 - On
UNIT PACKAGE: 15



14291
(66435-648-000)
Black Nylon

Retaining Clip
Head Diameter: 11mm
Stem Length: 13mm
Panel Thickness: 5mm
Snaps into 5mm Hole

UNIT PACKAGE: 50



14282
(90687-SA5-003)
Black Nylon

Retaining Clip
Head Diameter: 13mm
Stem Length: 15mm
Panel Thickness: 4mm
Snaps into 5mm Hole

UNIT PACKAGE: 50



18157
(90672-671-003)
Gray Nylon

**Headliner & Cowl Grille
Retaining Clip**
Head Diameter: 13mm
Stem Length: 16mm
Panel Thickness: 5mm
Fits into 5mm Hole
Accord 1986-On

UNIT PACKAGE: 25



20381
(Honda: 90667-671-013ZA;
Mitsubishi: MC440901;
Nissan: 62660-48600-1)
Black Nylon

Trim Panel Retaining Clip
Head Diameter: 16mm
Stem Diameter: 7mm
Stem Length: 16mm
Honda, Mitsubishi & Nissan

UNIT PACKAGE: 25



22263
(91504-TBA-A01)
Black Nylon

Grille Retaining Clip
Head Diameter: 16mm
Stem Diameter: 8mm
Stem Length: 11mm
Honda Civic 2016 - On

UNIT PACKAGE: 25



20882
(91501-SEA-003)
Black Nylon

Cowl & Garnish Retainer
Head Diameter: 20mm
Stem Diameter: 7mm
Stem Length: 15mm
Civic 2006 - On

UNIT PACKAGE: 10



22054
(91501-SNA-003)
Black Nylon

Front Fender, Cowl & Dash Retainer
Head Diameter: 20mm
Stem Diameter: 7mm
Stem Length: 16mm
Honda Civic & CR-V 2014 - 06

UNIT PACKAGE: 15



21303
(90671-S0D-003ZK)
Black Nylon

**Trunk Lid &
Interior Trim Retainer**
Head Diameter: 18mm
Stem Diameter: 7mm x 7mm
Stem Length: 13mm
Accord 2010 - On

UNIT PACKAGE: 25



20334
(90667-SOD-003ZC)
Black Nylon

Trunk Garnish Retainer
Head Diameter: 18mm
Stem Diameter: 7.5mm Square
Stem Length: 20mm
Civic 1998 - On

UNIT PACKAGE: 15



18302
(GM: 20538173; Chry: 6104908-AA;
Mercedes: 002-997-33-86-67;
Honda: 91531-THR-A01)
Black Nylon

Weatherstrip Retaine
Head Diameter: 7/16"
Stem Diameter: 7/32"
Stem Length: 15/32"
Buick Century & Riviera, Chevrolet Lumina, Olds Aurora
& Regency and Pontiac Grand Prix 1989 - On;
Chrysler 2008 - On; Mercedes-Benz;
Acura TLX 2021 - On, Honda Odyssey 2018 - On

UNIT PACKAGE: 50



14289

(90666-SA0-003)
Black Nylon

Retainer

Head Diameter: 13mm
Stem Length: 16mm
Snaps into 5mm Hole

UNIT PACKAGE: 25



16776

(Honda: 90667-SA0-003;
Nissan: 76996-01P02)
Black Nylon

Trim Panel Retainer

Head Diameter: 18mm
Stem Length: 20mm
Fits into 6mm Hole

UNIT PACKAGE: 25



19470

(90108-SW3-003)
Black Nylon

Bumper Retainer

Head Diameter: 16mm
Stem Diameter: 4mm
Stem Length: 21mm

Use with Auveco 19650

Accord, Odyssey & Prelude 1995 - On

UNIT PACKAGE: 15



15998

(90700-SB2-003)
Black Nylon

Hood Insulation Retainer

Head Diameter: 30mm
Stem Length: 9mm
Fits into 6mm Hole
Honda Prelude 1985-On

UNIT PACKAGE: 15



19506

(90666-SA7-003ZW)
Black Nylon

Trunk Lining Retainer

Head Diameter: 16mm
Stem Diameter: 5mm Square
Stem Length: 16mm
Acura 2.5TL, 3.2TL, 3.5, Integra &
Legend, Honda Accord Wagon
& Prelude 1987 - On

UNIT PACKAGE: 15



18746

(90700-SJ4-000)
Black Nylon

Hood Insulation Retainer

Head Diameter: 30mm
Stem Diameter: 15mm x 18mm
Stem Length: 10mm
Acura Legend 1991 - On
Honda 1998 - On

UNIT PACKAGE: 15



19744

(90669-SP0-003ZA)
Black Nylon

Trunk Trim Retainer

Head Diameter: 16mm
Stem Diameter: 6mm
Stem Length: 27mm
Civic 1998 - On

UNIT PACKAGE: 10



20609

(91501-SIK-003, 91501-STK-003)
Black Nylon

Hood Insulation Retainer

Head Diameter: 30mm
Stem Diameter: 15mm x 20mm
Stem Length: 14mm
Acura 3.5RL & RSX and
Honda Civic & CR-V 2000 - On

UNIT PACKAGE: 25



16775

(Honda: 90667-SA7-003;
Nissan: 89427-98070)
Black Nylon

Trim Panel Retainer

Head Diameter: 20mm
Stem Length: 15mm
Fits into 5mm Hole

UNIT PACKAGE: 25



21652

(91501-SWA-003)
Black Nylon

Hood Insulation Retainer

Head Diameter: 30mm
Stem Diameter: 21mm
Stem Length: 14mm
Civic 2012 - On

UNIT PACKAGE: 25



18114

(91520-SM4-C01)
Black Nylon

Hood Insulation Retaining Clip

Head Diameter: 10mm
Stem Length: 10mm
Panel Thickness: 4mm
Fits into 6mm Hole
Honda & Acura 1990 - On

UNIT PACKAGE: 25



19682

(91518-S10-003)
Black Nylon

Hood Seal Retaining Clip

Head Diameter: 11mm
Stem Length: 8mm
Fits into 6mm Hole
Odyssey 1999 - On

UNIT PACKAGE: 25



19114

(91518-SM4-003)
Black Nylon

Hood & Trunk Moulding Retaining Clip

Head Diameter: 12mm
Stem Length: 9mm
Fits into 6mm Hole
Acura Integra & Honda Civic 1994 - On

UNIT PACKAGE: 10



25328

(Honda: 91532-SJA-003)
Black Nylon

Fender Garnish Molding & Hood Seal Clip

Bottom Head Diameter: 11mm
Stem Size: 5mm x 7mm
Stem Length: 10mm
Overall Height: 11mm

Acura NSX 2020 - 2017, RL 2012 - 2005,
TLX 2020 - 2018; Honda CR-V 2016 - 2012

UNIT PACKAGE: 50



17205

(91501-SM4-003)
Black Nylon

Cowl Top Retaining Clip

Head Diameter: 14mm
Stem Length: 15mm
Fits into 6mm Hole
Accord 1990 - On

UNIT PACKAGE: 15



14323

(38529-689A-6300)
Black Nylon

Retaining Clip

Head Diameter: 18mm
Stem Length: 15mm
Panel Thickness: 4mm
Snaps into 7mm Hole

UNIT PACKAGE: 25



16779

(Honda: 74842-659-0030;
Toyota: 90467-12078)
Black Nylon

Retaining Clip

Head Diameter: 18mm
Stem Length: 15mm
Panel Thickness: 6mm
Fits into 8mm Hole

UNIT PACKAGE: 25



14319

(90687-671-003)
Black Nylon

Retaining Clip

Head Diameter: 20mm
Stem Length: 20mm
Panel Thickness: 6mm
Snaps into 10mm Hole

UNIT PACKAGE: 25



20611

(90602-S7S-003)
Blue Nylon

Cowl Vent Retainer

Top Head Diameter: 12mm
Bottom Head Diameter: 16mm
Stem Diameter: 3mm
Stem Length: 7mm
Accord 2003 - On

UNIT PACKAGE: 25



21696

(90602-S2A-003)
Pale Yellow Nylon

Cowl Retainer

Top Head Diameter: 12mm
Bottom Head Diameter: 16mm
Stem Diameter: 4mm
Stem Length: 6.5mm
Honda Civic, Element, Fit, Insight & S2000 2001 - On

UNIT PACKAGE: 25



21107
(90602-SX0-003)
White Nylon

Cowl Vent Retainer
Top Head Diameter: 12mm
Bottom Head Diameter: 16mm
Stem Diameter: 4mm
Stem Length: 13mm
Acura MDX, Honda Civic, Insight,
Odyssey & Prelude 1995 - On

UNIT PACKAGE: 10



22514
(Honda: 91512-SED-003)
Black Nylon

Inner Fender Wheel Well Retainer
Head Diameter: 18mm
Stem Diameter: 4.1mm
Stem Length: 16mm
Honda Civic, Odyssey & Pilot 2005 - On

UNIT PACKAGE: 25



25069
(Acura & Honda: 91501-T2A-003)
Black Nylon

Fender Liner Retainer
Top Head Diameter: 18mm
Stem Diameter: 4.3mm
Stem Length: 15mm
Overall Height: 17mm
Acura RLX 2014 - On; Honda Accord 2013 - On; Clarity,
CR-V 2017 - On; Fit 2015 - On; HR-V 2016 - On

UNIT PACKAGE: 25



21417
(90602-TA0-003)
Blue Nylon

Cowl Vent Retainer
Top Head Size: 10mm x 14mm
Bottom Head Diameter: 16mm
Stem Diameter: 8mm
Stem Length: 13mm
Acura TSX & ZDX and Honda Accord & Fit 2008 - On

UNIT PACKAGE: 10



23978
(90602-SLJ-003, 90603-SLJ-003)
Nylon

Cowl Vent Retainer
Top Head Size: 10mm x 14mm
Bottom Head Diameter: 16mm
Stem Diameter: 8mm
Stem Length: 13mm
Acura RDX & Honda CR-V 2007 - On

UNIT PACKAGE: 10



22588
(Honda: 91547-TZ5-A02)
Black Nylon

Engine Cover Retainer
Top Head Diameter: 13mm
Bottom Head Diameter: 14mm
Stem Length: 17mm
Overall Length: 22mm
Acura MDX, RDX & TLX 2014 - On
Honda Odyssey, Pilot & Ridgeline 2016 - On

UNIT PACKAGE: 50



22243
(91560-S04-003)
White Nylon

Side Panel Moulding Retainer
Top Head Diameter: 13mm
Bottom Head Diameter: 16mm
Stem Diameter: 9.5mm
Stem Length: 12mm
Honda Accord 2015 - 1998, Civic 2011 - 2007

UNIT PACKAGE: 25



19145
(91560-SP0-003)
Gray Nylon

Front & Rear Door Trim Panel Retainer
Top Head Diameter: 13mm
Middle Head Diameter: 17mm
Stem Diameter: 9mm
Stem Length: 12mm
Overall Length: 18.5mm
Acura & Honda Accord, Civic,
Prelude, Odyssey & Del Sol 1991 - On

UNIT PACKAGE: 25



20411
(91560-S84-A11)
Black Nylon

Windshield Garnish Pillar Retainer
Top Head Diameter: 13mm
Middle Head Diameter: 16mm
Bottom Head Diameter: 14.5mm
Stem Diameter: 9.5mm
Stem Length: 12mm
Acura 3.2CL, Honda Accord,
Insight & Odyssey 1998 - On

UNIT PACKAGE: 15



21554
(91560-S7A-003)
Black Nylon

Trim Panel Retainer with Sealer
Top Head Diameter: 13mm
Middle Head Diameter: 16mm
Bottom Head Diameter: 15mm
Stem Diameter: 9.5mm
Stem Length: 11mm
Overall Length: 18.5mm
Crosstour, Fit & Odyssey 2010 - 05

UNIT PACKAGE: 25



21149
(91560-S84-A01)
White Nylon

Trim Panel Retainer
Top Head Diameter: 13mm
Middle Head Diameter: 16.5mm
Bottom Head Diameter: 15mm
Stem Diameter: 9.5mm
Stem Length: 11mm
Overall Length: 17.5mm
Accord & Element 2003 - On

UNIT PACKAGE: 25



21675
(91560-SZW-003)
Green Nylon

Door Panel & Interior Trim Retainer
Top Head Diameter: 13mm
Middle Head Diameter: 16mm
Bottom Head Diameter: 18mm
Stem Diameter: 9.5mm
Stem Length: 11mm
Overall Length: 18mm
Civic 2012 - On

UNIT PACKAGE: 25



21638
(91560-S0X-A01)
White Nylon

Trim Panel Retainer with Sealer
Top Head Diameter: 13mm
Middle Head Diameter: 16.5mm
Bottom Head Diameter: 15mm
Stem Diameter: 9.5mm
Stem Length: 11mm
Overall Length: 17.5mm
Accord, CR-V, Fit & Odyssey 1999 - On

UNIT PACKAGE: 15



20959
(91560-S9A-A01)
Blue Nylon

Door Panel Retainer
Top Head Diameter: 13mm
Middle Head Diameter: 16mm
Bottom Head Diameter: 15mm
Stem Diameter: 9.5mm
Stem Length: 13mm
Acura TL & TSX and Honda Accord, Civic, CR-V & Odyssey 2002 - On

UNIT PACKAGE: 25



21208
(91560-SLJ-J01)
Gray Nylon

Door Trim Panel Retainer
Top Head Diameter: 13mm
Middle Head Diameter: 16mm
Bottom Head Diameter: 18mm
Stem Length: 12mm
Fits into 8.5mm Hole
Acura RDX and Honda Civic, CR-V & Pilot 2009 - On

UNIT PACKAGE: 10



21087
(90602-SAA-003)
Orange Nylon

Cowl Vent & Radiator Support Retainer
Top Head Diameter: 12mm
Middle Head Diameter: 16mm
Bottom Head Diameter: 18mm
Stem Diameter: 9.7mm
Stem Length: 14mm
Overall Length: 20.5mm
Fit & CR-V 2003 - On

UNIT PACKAGE: 15



21676
(91560-SZW-J01)
Dull Yellow Nylon

Windshield Moulding & Interior Trim Retainer
Top Head Diameter: 13mm
Middle Head Diameter: 16mm
Bottom Head Diameter: 18mm
Stem Diameter: 9.5mm
Stem Length: 12mm
Overall Length: 19mm
Civic 2012 - On

UNIT PACKAGE: 25



21206
(Honda: 91560-S6A-003,
Ford: W718230-S300)
Orange Nylon

Rear Liftgate Retainer
Top Head Diameter: 13mm
Middle Head Diameter: 16mm
Bottom Head Diameter: 18mm
Stem Length: 14mm
Fits into 8.5mm Hole
Honda Fit 2009 - On; Ford Escape, Explorer 2020 - On, Expedition 2018 - On, Transit 150-350 2014 - On
Lincoln Aviator, Corsair 2020 - On, Navigator 2018 - On

UNIT PACKAGE: 15



25269
(Honda: 91560-TRT-J01)
Natural Nylon

Door Panel & Carpet Retainer with Sealer
Top Head Diameter: 13mm
Middle Head Diameter: 16mm
Bottom Head Diameter: 18mm
Stem Diameter: 9.5mm
Stem Length: 13mm
Overall Length: 19mm
Acura TLX 2021 - On; Honda CR-V 2019,
Clarity 2017 - On, Insight 2019 - On

UNIT PACKAGE: 25



22545
(Honda: 91560-TL0-G21)
Tan Nylon

Garnish Retainer With Sealer
Top Head Diameter: 13mm
Middle Head Diameter: 16.5mm
Bottom Head Diameter: 18mm
Stem Diameter: 9mm
Stem Length: 9mm
Acura RDX, TSX, ILX, RLX & TLX and Honda
Accord, CR-V & Odyssey 2007 - On

UNIT PACKAGE: 15



22544
(Honda: 91560-TG1-T01)
Green Nylon

Garnish Retainer With Sealer
Top Head Diameter: 13mm
Middle Head Diameter: 16.5mm
Bottom Head Diameter: 18mm
Stem Diameter: 9.3mm
Stem Length: 12mm
Honda Accord, Civic, CR-V, Fit, HR-V,
Odyssey & Pilot 2013 - On

UNIT PACKAGE: 15



20610
(91560-SM4-003)
White Nylon

Door Trim Panel Retainer
Top Head Diameter: 13mm
Middle Head Diameter: 18mm
Bottom Head Diameter: 16mm
Stem Diameter: 9mm
Stem Length: 15mm
Overall Length: 21mm
Accord 1990 - On

UNIT PACKAGE: 25



18294
(91566-SP0-003)
White Nylon

Trim Panel Retainer
Top Head Diameter: 13mm
Middle Head Diameter: 18mm
Stem Length: 14mm
Fits into 9mm Hole
Honda 1990-On

UNIT PACKAGE: 15



21059
(90602-S5A-003)
Blue Nylon

Cowl Vent Retainer
Top Head: 12mm x 13mm
Middle Head Diameter: 16mm
Bottom Head Diameter: 18mm
Stem Diameter: 8.5mm x 8.5mm
Stem Length: 14mm
Overall Length: 21mm
Acura RSX and Honda Civic & CR-V 2001 - On

UNIT PACKAGE: 15



22469
(Honda: 90651-T3L-003)
Black Nylon

Rear Bumper Garnish Retainer
Top Head Diameter: 13mm
Middle Head Diameter: 16.5mm
Bottom Head Diameter: 18mm
Stem Diameter: 9.3mm
Stem Length: 14mm
Acura NSX & RDX 2016 - On
and Honda Accord & Civic 2017 - 2013



UNIT PACKAGE: 25



22499
(Honda: 91560-TX4-A01)
Yellow Nylon

Garnish Retainer with Sealer
Top Head Diameter: 13mm
Middle Head Diameter: 16.3mm
Bottom Head Diameter: 18mm
Stem Diameter: 9.5mm
Stem Length: 13mm
Acura ILX, MDX, RDX, RLX & TLX and Honda
Civic, Clarity, CR-V, Fit, HR-V, Odyssey, Pilot
& Ridgeline 2013 - On



UNIT PACKAGE: 25



21141
(Honda: 91561-SJD-003)
Black & White Nylon

Pillar, Rocker Panel & Floor Retainer
Top Head Diameter: 15mm
Middle Head Diameter: 16mm
Bottom Head Diameter: 18mm
Stem Diameter: 8mm
Stem Length: 13mm
Honda Civic 2006 - On, Clarity 2017 - On,
CR-V 2020 - 2012, Fit 2008 - 2007, Pilot 2004 - On

UNIT PACKAGE: 10



21458
(91567-S3M-000)
Black Nylon

Weatherstrip Retainer
Head Diameter: 10mm
Stem Diameter: 5.5mm
Stem Length: 7mm
Accord, Civic & Odyssey 2003 - On

UNIT PACKAGE: 25



22586
 (Honda: 90651-TG7-000)
 Black Nylon
Door Seal Retainer
 Head Diameter: 10.6mm
 Stem Diameter: 5.5mm
 Stem Length: 8mm
 Honda Pilot & Ridgeline 2017 - On
UNIT PACKAGE: 50



22553
 (Honda: 90651-T2M-003)
 Black Nylon
Weatherstrip Retainer
 Head Size: 4mm x 10mm
 Stem Diameter: 6.5mm
 Stem Length: 7mm
 Honda Accord & Clarity 2014 - On
UNIT PACKAGE: 25



14299
 (73862-672-003)
 White Nylon
Weatherstrip Retainer
 Width: 7mm
 Length: 16mm
 Stem Length: 5mm
 Fits into 5mm Hole
UNIT PACKAGE: 50



14328
 (90664-671-003, 91530-SE0-003)
 White Nylon
Weatherstrip Retainer
 Width: 7mm
 Length: 16mm
 Stem Length: 10mm
 Fits into 5mm Hole
UNIT PACKAGE: 50



19673
 (72311-S10-003)
 Black Nylon
Weatherstrip Retainer
 Head Size: 10mm x 15mm
 Stem Diameter: 5mm
 Stem Length: 10mm
 CR-V 1997 - On
UNIT PACKAGE: 15



18818
 (91513-SE0-003)
 Natural Nylon
Hood Seal Retainer
 Head Size: 7mm x 16mm
 Stem Length: 12mm
 Fits into 5mm Hole
 Accord & Prelude 1983 - On
UNIT PACKAGE: 25



21773
 (91530-S0A-003)
 Black Nylon
Roof Rail & Side Sill Weatherstrip Retainer
 Top Head Size: 5mm x 11mm
 Bottom Head Diameter: 8mm
 Stem Diameter: 6mm
 Stem Length: 7mm
 Acura Legend, MDX, RDX,
 RL, TL & ZDX 1998 - On
 Honda Accord, Civic, CRV,
 Element & Odyssey 2001 - On
UNIT PACKAGE: 25



22551
 (Honda: 90651-TA0-003)
 Natural Nylon
Door Panel & Weatherstrip Retainer
 Top Head: 5mm x 12mm
 Bottom Head Diameter: 12mm
 Stem Diameter: 6mm
 Stem Length: 4.5mm
 Acura ILX, MDX, RDX, RLX & ZDX 2010 - On
 Honda Accord, CR-V, Pilot, Ridgeline 2008 - On
UNIT PACKAGE: 50



21705
 (90651-TP8-003,
 91568-TR0-003)
 Yellow Nylon
Weatherstrip Retainer
 Top Head Size: 5mm x 15mm
 Bottom Head Diameter: 7.5mm
 Stem Diameter: 6.5mm
 Stem Length: 7mm
 Acura ILX & RDX and Honda Civic & CR-V 2012 - On
UNIT PACKAGE: 25



21707
 (Honda: 91563-SCV-003)
 (Toyota: 67867-52010, 67867-0D060)
 White Nylon
Weatherstrip Retainer
 Head Size: 5mm x 15mm
 Bottom Head Diameter: 6.5mm
 Stem Diameter: 7mm
 Stem Length: 8.5mm
 Acura TL and Honda Element
 Odyssey & Pilot 2003 - On
 Toyota Echo, Land Cruiser, Prius, Tacoma &
 Yaris and Lexus GS 450, GX 460 &
 LX 430 and Scion xA & xD 2000 - On
UNIT PACKAGE: 25



21704
 (72311-S5S-003)
 Green Nylon
Weatherstrip Retaining Clip
 Top Head Size: 5mm x 15mm
 Bottom Head Diameter: 9.5mm
 Stem Diameter: 7mm
 Stem Length: 11mm
 Acura RDX and Honda Civic,
 CR-V & Fit 2003 - On
UNIT PACKAGE: 25



25065
(Acura & Honda: 90565-TZ5-003)
Black Nylon

Weatherstrip Retainer
Top Head Size: 4.7mm x 12mm
Bottom Head Diameter: 7mm
Stem Size: 4.5mm x 6.5mm
Stem Length: 7.5mm
Overall Height: 11.5mm
Fits into 5mm Hole
Acura MDX 2014 - On;
Honda Accord 2018 - On; Civic,
Pilot, Ridgeline, CR-V 2016 - On; Insight,
Passport 2019 - On

UNIT PACKAGE: 25



18877
(91530-SPI-003)
Orange Nylon

Weatherstrip Retainer
Head Size: 5mm x 15mm
Stem Length: 10mm
Fits into 6mm Hole
Acura 3.5 RL & Honda Accord,
Civic & Odyssey 1992 - On

UNIT PACKAGE: 25



19116
(91530-ST5-003)
Natural Nylon

Weatherstrip Retainer
Head Size: 5mm x 15mm
Stem Length: 10mm
Fits into 6mm Hole
Front & Rear Doors
Civic 1995 - On

UNIT PACKAGE: 10



19171
(91568-SR2-003)
Green Nylon

Weatherstrip Retainer
Head Size: 5mm x 15mm
Stem Length: 10mm
Fits into 5mm Hole
Odyssey 1995 - On

UNIT PACKAGE: 100



19683
(91502-S84-A11)
Black Nylon

Cowl Vent Retaining Clip
Head Diameter: 6mm x 16mm
Stem Length: 14mm
Fits into 6mm Hole
Odyssey 1999 - On

UNIT PACKAGE: 15



19483
(91515-SR3-000)
Black Nylon

**Rear Hood Cowl
Weatherstrip Retaining Clip**
Head Size: 8mm x 18mm
Stem Length: 15mm
Fits into 7mm Hole
Acura Integra, Honda Civic,
CR-V & Del Sol 1992 - On

UNIT PACKAGE: 25



22136
(75315-S9A-004)
White Nylon

Lower Outer Door Weatherstrip Clip
Top Head Size: 12mm x 15mm
Bottom Head Size: 14mm x 20mm
Stem Length: 10mm
Honda CR-V 2002 - On

UNIT PACKAGE: 15



24533
(91514-T0A-A01)
Black Nylon

Fender Moulding Push-Type Retainer
Hole Size: 6mm
Head Diameter: 10mm
Stem Length: 8mm
Honda-CRV & Pilot 2012 - On

UNIT PACKAGE: 20



19186
(90657-SB0-003)
Black Nylon

**Front Bumper Cover
Push-Type Retainer**
Head Diameter: 11mm
Stem Length: 10mm
Fits into 8mm Hole
Acura Legend, Honda Accord
& Odyssey 1991 - On

UNIT PACKAGE: 10



22199
(90657-SA5-003)
Black Nylon

**Bumper & Splash Shield
Push-Type Retainer**
Head Diameter: 15mm
Stem Length: 12mm
Fits into 6.3mm Hole
Acura TL 2008 - 04
Honda Accord, CR-V, Insight & Pilot 2007 - 1997

UNIT PACKAGE: 15



19547
(91508-S50-003)
Black Nylon

Cowl Top Retainer
Head Diameter: 17mm
Stem Length: 13mm (Excluding the Pin)
Fits into 9mm Hole
Accord & Odyssey 1998 - On

UNIT PACKAGE: 5



18165
(91508-SR3-000)
Black Nylon

Cowl Panel Push-Type Retainer
Head Diameter: 17mm
Stem Length: 9mm
Fits into 8mm Hole
Honda 1990 - On

UNIT PACKAGE: 10



20247
(Mitsubishi: MR200300)
Black Nylon

Fender & Bumper Push-Type Retainer
Head Diameter: 18mm
Stem Length: 12mm
Fits into 9mm Hole
Honda & Mitsubishi 1998 - On

UNIT PACKAGE: 15



17192
(91508-SM4-003)
Black Nylon

Cowl Panel Push-Type Retainer
Head Diameter: 18mm
Stem Length: 14mm
Fits into 8mm Hole
Accord 1990-On

UNIT PACKAGE: 10



19453
(Honda: 90505-SX0-003
Tesla: 1006535-00-A)
Black Nylon

Garnish Side Protector, Front Bumper, Wheel Apron, Engine Under Cover Push-Type Retainer
Head Diameter: 18mm
Stem Length: 15mm (Excluding the Pin)
Fits into 8mm Hole
Honda Odyssey 1995 - On
Tesla S 2016 - On

UNIT PACKAGE: 15



19118
(Honda: 91501-S04-003, Ford: W711712-S300)
Black Nylon

Front Fender Push-Type Retainer
Head Diameter: 20mm
Stem Length: 10mm
Fits into 8mm Hole
Honda Civic & Del Sol 1993 - On;
Ford Escape 2016 - 2013, Explorer 2020 - On,
Focus 2018 - 2012, Transit 2014 - On,
C-Max 2013 - 2018, Focus 2012 - 2018,
Bronco 2021 - On, Lincoln Aviator 2020 - On

UNIT PACKAGE: 15



21651
(91501-TR0-003)
Black Nylon

Fender Push-Type Retainer
Head Diameter: 20mm
Stem Length: 10mm
Fits into 8mm Hole
Civic 2012 - On

UNIT PACKAGE: 25



21297
(91503-S7A-003)
Black Nylon

Front Bumper Push-Type Retainer
Head Diameter: 20mm
Stem Length: 11mm
Fits into 10mm Hole
Civic 2010 - On

UNIT PACKAGE: 15



19233
(91503-SZ3-003)
Black Nylon

Front Bumper Push-Type Retainer
Head Diameter: 20mm
Stem Length: 13mm
Fits into 10mm Hole
Acura 3.5 RL Sedan & Honda 1996 - On

UNIT PACKAGE: 15



20986
(91505-S9A-003)
Black Nylon

Front Bumper Push-Type Retainer with Internal Metal Insert
Head Diameter: 20mm
Stem Length: 13mm
Fits into 10mm Hole
Civic 2006 - On

UNIT PACKAGE: 10



22446
(Honda: 91503-T1W-003)
Gray Nylon

Bumper Push-Type Retainer
Head Diameter: 20mm
Stem Length: 13mm
Fits into 10mm Hole
Honda CR-V 2015 - On

UNIT PACKAGE: 15



19239
(GM: 11519949;
Honda: 91512-SX0-003;
Mitsubishi: MU000319;
Lexus & Toyota: 90467-08217)
Black Nylon

Front Fender, Bumper Support, Interior Trim & Washer Tank Push-Type Retainer
Head Diameter: 20mm
Stem Length: 11mm
Fits into 8mm Hole
Acura 3.5RL, Honda Accord, Prelude &
Odyssey 1994 - On; Mitsubishi Lancer 2002 - On;
GM 1997 - On; Lexus GX470 2009 - 2003;
Toyota 4Runner 2009 - 2003, FJ Cruiser 2014 - 2007,
Tacoma 2016 - 2005

UNIT PACKAGE: 25



20608
(91503-S0K-A01)
Black Nylon

Grille Mounting Push-Type Retainer
Head Diameter: 20mm
Stem Length: 14mm
Fits into 10mm Hole
Element 2003 - On

UNIT PACKAGE: 15



21706
(91505-TM8-003)
Black Nylon

Bumper and Wheel Well Liner Push-Type Retainer
Head Diameter: 20mm
Stem Length: 14mm
Fits into 10mm Hole
Acura ILX and Honda Insight 2012 - On

UNIT PACKAGE: 15



21173
(91506-S9A-003)
Black Nylon

Bumper & Splash Shield Push-Type Retainer with Metal Insert
Head Diameter: 20mm
Stem Length: 16mm
Fits into 10mm Hole
Acura and Honda Accord, Civic, CR-V & Fit 2009-04

UNIT PACKAGE: 10



20564
(91503-SZ5-003)
Black Nylon

Front & Rear Bumper Push-Type Retainer
Head Diameter: 20mm
Stem Length: 18mm
Fits into 10mm Hole
Acura 3.5RL and Honda Accord & Odyssey 1996 - On

UNIT PACKAGE: 15



22419
(Honda: 90501-SDR-003)
Black Nylon

Rocker Moulding & Mud Guard Push-Type Retainer
Head Diameter: 20mm
Stem Length: 21mm
Fits into 10mm Hole
Acura RDX, RL & RLX and Honda CR-V & Accord 2009 - On

UNIT PACKAGE: 25



22112
(91512-STK-A01)
Black Nylon

Garnish & Rear Spoiler Push-Type Retainer with Sealer
Head Diameter: 20mm
Stem Length: 13mm
Fits into 8.5mm Hole
Acura RDX & TSX and Honda Accord, CR-V & Odyssey 2011 - On

UNIT PACKAGE: 10



22068
(91513-SJK-003)
White Nylon

Rocker, Pillars, Spoiler, Garnish & Exterior Trim Push-Type Retainer with Sealer
Head Diameter: 20mm
Stem Length: 13mm
Fits into 8.5mm Hole
Acura MDX, RLX, TSX & ZDX and Honda Accord, Civic, CR-V, Element, Fit, Insight & Pilot 2007 - On

UNIT PACKAGE: 15



22069
(Honda: 91512-SJK-003)
White Nylon

Rocker, Pillars, Garnish & Exterior Trim Push-Type Retainer with Sealer
Head Diameter: 20mm
Stem Length: 13mm
Fits into 8.5mm Hole
Acura ZDX 2013 - 2010
Honda Odyssey & Pilot 2005 - On

UNIT PACKAGE: 15



21190
(91550-S50-000ZL)
Black Nylon

Interior Trim Push-Type Retainer
Head Diameter: 16mm
Stem Length: 14mm
Fits into 7mm Hole
Civic, CR-V, Element & Insight 2006 - 2000

UNIT PACKAGE: 15



21477
(91550-S50-000ZK)
Gray Nylon

Push-Type Retainer
Head Diameter: 16mm
Stem Length: 14mm
Fits into 7mm Hole
Civic, CR-V, Element & Insight 2006 - 2000

UNIT PACKAGE: 15



19416

(Toyota: 90467-09139)
Black Nylon

Bumper Cover & Wheel Housing Push-Type Retainer
Head Diameter: 18mm
Stem Length: 12mm Excluding Pin
Fits into 9mm Hole
Honda, Mazda 626 &
Toyota Corolla 1992 - On

UNIT PACKAGE: 15



16782

(Honda: 91545-SE0-003-WI;
Nissan: 63848-01G00)
Black Nylon

Push-Type Retainer
Head Diameter: 20mm
Stem Length: 8mm (Excluding Pin)
Fits into 8mm Hole

UNIT PACKAGE: 25



22394

(Honda: 91561-TA0-A11,
91561-TA5-A11)
Metal & Green Nylon

Interior Trim, Pillars, Rocker Panel, Quarter Panel & Windshield Push-Type Retainer

Head Diameter: 18mm
Stem Length: 13mm
Overall Length: 38mm
Fits into 9mm Hole

Acura TL and Honda Accord, Civic, CR-Z,
Fit, Odyssey, Pilot & Ridgeline 2008 - On

UNIT PACKAGE: 5



17287

(90687-SB0-003, 90687-SB0-013)
Black Nylon

Cowl Vent Panel Retainer

Head Diameter: 13mm
Stem Length: 11mm
Fits into 6mm Hole
Prelude 1983 - On

UNIT PACKAGE: 25



14697

(GM: 94198687;
Honda: 90657-SA6-0030;
Mazda: N304-13-356-A)
Black Nylon

Push-Type Retainer
Head Diameter: 14mm
Stem Length: 11mm
Fits into 7mm Hole

UNIT PACKAGE: 25



14696

(Honda: 90684-SA5-003;
Isuzu: 8942981190;
Nissan: 10998-30880)
Black Nylon



Push-Type Retainer
Head Diameter: 15mm
Stem Length: 11mm
Fits into 6mm Hole

UNIT PACKAGE: 25



19311

(90683-SA5-003)
Black Nylon

Front Fender Skirt Push-Type Retainer

Head Diameter: 15mm
Stem Length: 13mm
Fits into 6mm Hole
Prelude 1996 - 92



UNIT PACKAGE: 15



19142

(91550-SH3-003)
Black Nylon

Pillar Garnish, Side and Trunk Lining Push-Type Retainer

Head Diameter: 15mm
Stem Length: 13mm
Fits into 7mm Square Hole
Civic, Accord Wagon & Del Sol 1993-On



UNIT PACKAGE: 5



20352

(91561-S84-A00-M1,
91561-S84-A21ZB)
Black Nylon

Rear Panel Assembly Push-Type Retainer

Head Diameter: 16mm
Stem Length: 21mm
Fits into 8mm Hole
Honda Accord & Civic 2007 - 01
Fit 2014 - 09



UNIT PACKAGE: 10



19546

(91570-SK7-003ZF)
Black Nylon

Tailgate Lining Retainer

Head Diameter: 17mm
Stem Length: 16mm
Fits into 7mm Square Hole
Prelude 1997 - On



UNIT PACKAGE: 10



17081
(91524-SE0-003)
Black Nylon

Cowl Push-Type Retainer
Head Diameter: 18mm
Stem Length: 12mm
Fits into 6mm Hole
Accord 1986-On

UNIT PACKAGE: 25



14698
(90688-SB0-003)
Black Nylon

Push-Type Retainer
Head Diameter: 18mm
Stem Length: 11mm
Fits into 6mm Hole

UNIT PACKAGE: 25



22482
(Honda: 91514-TF0-003)
Black Nylon

**Rocker Moulding
Push-Type Retainer**
Head Diameter: 18mm
Stem Length: 13mm
Fits into 9mm x 9mm Square Hole
Honda Accord, Fit & Fit EV 2009 - On

UNIT PACKAGE: 25



17057
(90505-SM4-003)
Black Nylon

Push-Type Retainer
Head Diameter: 18mm
Stem Length: 21mm
Fits into 8mm Hole
Accord 1990 - On

UNIT PACKAGE: 10



16000
(Honda: 90675-SB3-003;
Mazda: FB01-56-964;
Nissan: 63876-95596)
Black Nylon

Push-Type Retainer
Head Diameter: 20mm
Stem Length: 9mm
Fits into 8mm Hole

UNIT PACKAGE: 25



17379
(91512-SM4-003)
Black Nylon

**Fender Splash Shield
Push-Type Retainer**
Head Diameter: 20mm
Stem Length: 9mm
Fits into 8mm Hole
Accord 1990-On

UNIT PACKAGE: 10



17350
(Honda 91516-SK7-013;
Nissan 01553-00344)
Black Nylon

**Splash Shield Push-Type Retainer
Phillips Drive**

Hex: 10mm
Head Diameter: 20mm
Stem Length: 15mm
Fits into 8mm Hole
Civic 1992 - On
Nissan XTerra, Frontier, & Quest 1999 - On

UNIT PACKAGE: 10



22367
(Honda: 91514-TR3-A01)
Black Nylon

**Fender Liner Push-Type Retainer with
Phillips Truss Head Stainless Steel Screw**
Screw Head Diameter: 15.5mm
Nylon Grommet
Head Diameter: 15mm
Stem Length: 10mm
Fits into 9mm Square Hole
Honda Civic 2015 - 2014

UNIT PACKAGE: 5



22434
(Honda: 91514-SLN-A01)
Black Metal & Nylon

**Front Fender Liner &
Engine Cover Push-Type Retainer with
Phillips Truss Head Stainless Steel Screw**
Head Diameter: 15.5mm
Grommet Head Size: 19.3mm x 19.3mm
Stem Length: 10mm
Fits into 10mm Hole
Honda Fit & Insight 2014 - 2007

UNIT PACKAGE: 5



17144
(91504-SM4-000)
Black Nylon

Push-Type Retainer Bumper Fascia
Head Diameter: 20mm
Stem Length: 24mm
Fits into 10mm Hole
Accord 1990 - On

UNIT PACKAGE: 10

19408

Same as 17144 except for unit package quantity
UNIT PACKAGE: 50



18119
(91502-SP0-003)
Black Nylon

Front & Rear Bumper Push-Type Retainer
Head Diameter: 20mm
Stem Length: 25mm
Fits into 10mm Hole
Honda 1990 - On

UNIT PACKAGE: 10



17143
(Honda: 91502-SM4-000;
Hyundai: 85690-35000)
Black Nylon

Push-Type Retainer Bumper Fascia
Head Diameter: 20mm
Stem Length: 27mm
Fits into 10mm Hole
Accord 1990-On Hyundai 2005 - On
UNIT PACKAGE: 10

19407

Same as 17143 except for unit package quantity
UNIT PACKAGE: 50



22703
(Honda: 91505-TY2-003)
Black Nylon

Engine Cover Push-Type Retainer
Head Diameter: 30mm
Stem Length: 12mm
Fits into 10mm Hole
Honda Accord, Civic,
Clarity, CR-V & Fit 2017 - On

UNIT PACKAGE: 15



16949
(90652-SB2-023)
Nylon

Windshield Washer Hose Retainer
Holds hose with:
Inner Diameter : 3mm (7/64") 5mm
Outer Diameter: (13/64")
Fits into 7mm (9/32") Square Hole
Honda 1986 - On

UNIT PACKAGE: 15



14688
(91547-SE0-003)
Nylon

Hood Prop Rod Clip
Holds 6mm Prop Rod
Snaps into 7mm Hole

UNIT PACKAGE: 25



14687
(90677-671-003)
Nylon

Hood Prop Rod Clip
Holds 8mm Prop Rod
Snaps into 9mm x 9mm Hole

UNIT PACKAGE: 25



22548
(Honda: 90672-SNA-A01)
Black Nylon

Hood Prop Rod Clip
Holds 8mm Rod
Head Diameter: 18mm
Stem Length: 10mm
Overall Length: 26.5mm
Honda Civic, Fit & Odyssey 2006 - On
UNIT PACKAGE: 25



21170
(91591-SJ6-013)
Natural Nylon

Door Lock Rod Clip
Rod Size: 5mm
Overall Height: 17mm
Fits into 7mm Hole
Acura TSX and Honda Accord,
Odyssey & Ridgeline 2003 - On
UNIT PACKAGE: 15



21388
(91558-SE3-003)
Black Nylon

Sliding Door Lock and Hood & Fuel Door Release Cable Clip
Maximum Cable Diameter: 5mm
Closed Height Position: 17mm
Acura and Honda Accord, Civic,
CR-V, Insight, Odyssey, Pilot, Prelude &
Ridgeline 1991 - On
UNIT PACKAGE: 25



25408
(Honda: 82871-671-000)
Black Rubber

Body Drain Hole Plug
Width: 8mm
Head Diameter: 33mm
Fits into 25mm Hole
Overall Height: 10mm
Acura RLX 2020 - 2018, CL 2003 - 1997, ILX 2013,
Integra 2001 - 1987, Legend 1995 - 1986,
MDX 2013 - 2001, MSX2005 - 1991, RDX 2015 - 2007,
RL 2012 - 1996, RLX 2017 - 2014, RSX 2006 - 2002,
TL 2014 - 1995, TSX 2014 - 2004, Vigor 1994 - 1992,
ZDX 2013 - 2010; Honda 600 1972 - 1970,
Accord 207 - 1976, Civic 2018 - 1973,
Crosstour 2015 - 2011, CR-V 2016 - 2000,
CR-Z 2016 - 2011, CRX 1991 - 1984, Del Sol 1997 - 1995,
Element 2011 - 2003, Fit 2020 - 2007, HR-V 2016 - On,
Insight 2014 - 2010, Odyssey 2017 - 1995,
Pilot 2015 - 2003, Prelude 2001 - 1979,
Ridgeline 2014 - 2006, S2000 2009 - 2000
UNIT PACKAGE: 15



22518
(Honda: 91504-SDA-003)
Black Nylon

Hood Release Cable Clip
Holds 5mm Diameter Cable
Stem Length: 6.5mm
Fits into 7mm Hole
Honda Accord, Civic & Clarity 2003 - On
UNIT PACKAGE: 25



25327
(Honda: 90825-T2A-003)
Black Rubber



Underbody & Fender Hole Plug

Head Size: 33.5mm
Fits into 25mm Hole
Overall Height: 7.5mm
Acura ILX, RLX 2020 - 2014, NSX 2020 - 2017,
RDX 2021 - 2015, TLX 2020 - 2015, TSX 2014;
Honda Accord, Civic, CR-V 2020 - 2013,
Clarity 2021 - 2017, Crosstour 2015 - 2014,
CR-Z 2016 - 2014, Fit 2020 - 2015, HR-V 2020 - 2016,
Insight 2021 - 2013, Odyssey 2021 - 2018

UNIT PACKAGE: 50



25330
(Honda: 95550-07000)
Dark Gray Nylon

Body Hole Plug

Head Diameter: 15mm
Fits into 7mm Hole
Overall Height: 8mm
Acura CL 2003 - 1997, Integra 2001 - 1991,
Legend 1990 - 1989, MDX 2020 - 2001,
NSX 2005 - 1991, RDX 2013, RL 2012 - 2005,
RLX 2020 - 2014, RSX 2006 - 2002, TL 2007 - 1995,
TSX 2014 - 2004, Vigor 1994 - 1992;
Honda Accord 2017 - 1990, Civic 2020 - 1988,
Clarity 2021 - 2017, CR-V 2019 - 1997,
CRX 1991 - 1988, CR-Z 2016 - 2011,
Element 2006 - 2003, Fit 2013 - 2007,
Insight 2014 - 2001, Odyssey 2007 - 1995,
Passport 2020 - 2019, Pilot 2007 - 2003,
Prelude 2001 - 1988, Ridgeline 2006, S2000 2009 - 2000

UNIT PACKAGE: 50



25068
(Acura & Honda: 90820-SNA-003)
Black Nylon

Door Hole Plug

Head Size: 29mm
Fits into 20mm Hole
Overall Height: 9.5mm
Acura ILX 2013 - On; MDX 2008 - On;
RDX 2007 - On; TLX 2015 - On;
TL 2014 - 2008; ZDX 2013 - 2010;
Honda Accord 2008 - On;
Civic 2006 - On; CR-V 2007 - On; Fit,
Pilot, Ridgeline 2009 - On;
HR - V 2016 - On; Insight,
Passport 2019 - On; Odyssey 2008 - On;
Clarity 2018 - 2017; Crosstour 2015 - 2010;
Element 2011 - 2007

UNIT PACKAGE: 25



25070
(Honda: 95551-20000)
Black Nylon

Door Hole Plug

Head Size: 29mm
Fits into 20mm Hole
Overall Height: 8.5mm
Honda Civic 2001 - On;
Clarity 2017 - On;
Fit 2007 - On; CR-V 2019 - 2002;
Accord 2017 - 2000; CR-Z 2016 - 2011; Insight 2014 - 2010;
S2000 2009 - 2000; Odyssey, Pilot 2008 - 2005;
Ridgeline 2008 - 2006; Element 2006 - 2003

UNIT PACKAGE: 25



14298

(Honda: 90672-SA0-003; Mazda: 9928-91-053)
Nylon

Photo not actual size

Releasable Cable Strap

Overall Length: 140mm (5-1/2")
Max. Bundle Diameter: 30mm
Fits into 7mm Hole

UNIT PACKAGE: 25



20380

(Not Supplied by O.E.M.)
Black Nylon

Photo not actual size

Cable Strap

Width: 5mm (3/16")
Length: 200mm (8")
Max. Bundle Diameter: 44mm (1-3/4")
Fits into 6.3mm (1/4") Hole
Import Cars

UNIT PACKAGE: 25



16470
(90212-SA5-003)
Zinc

M10-1.25

Hex Flange Nut with Serrations

Flange Outer Diameter: 19mm
Hex: 14mm
Class 10

Used on Honda Exhaust Systems

UNIT PACKAGE: 25



25254
(Honda: 75891-SA7-000)
Rubber

Door Bumper

Diameter: 17mm
Overall Length: 17mm

Acura CL 2003 - 1997 ILX 2020 - 2013, Integra 2001 - 1986, Legend 1990 - 1986, MDX 2013 - 2007, MSX 2005 - 1991, RDX 2018 - 2007, RL 2012 - 2005, RLX 2020 - 2014, RSX 2006 - 2002, TL 2014 - 1995, TLX 2020 - 2015, TSX 2014 - 2004, Vigor 1994 - 1992, ZDX 2013 - 2010; Honda Accord 1986 - On, CR-V 1997 - On, CR-Z 2016 - 2011, CRX 1991 - 1985, Civic 1984 - On, Crosstour 2015 - 2010, Element 2011 - 2003, Fit 2020 - 2007, HR-V 2016 - On, Insight 2010 - On; Odyssey 2010 - 1995; Pilot 2015 - 2003, Prelude 2001 - 1992, Ridgeline 2014 - 2006, 2000 2009 - 2000

UNIT PACKAGE: 10



25268
(Honda: 91505-T5A-003)
Black Nylon

Undercover Retainer Nut

Fits: M6-1.0 Stud
Flange O.D.: 30mm
Hex Size: 17mm
1/4" Hex Socket Drive
Overall Height: 31mm

Honda Fit 2015 - On, HR-V 2016 - On

UNIT PACKAGE: 25



20570
(Honda: 75307-SN7-000;
Mini-Cooper: 07-13-0-702-715)
Black Nylon

Nylon Moulding Nut with Brass Insert

Thread: M4-0.7
Flange Outer Diameter: 12mm
Hex: 10mm
Height: 11mm
1994 - On

UNIT PACKAGE: 15



22942
(Acura & Honda: 90111-SM4-003)
Black

Bumper Bolt

Size: M6 - 1.0 x 8mm
Shoulder Diameter: 9mm
Shoulder Length: 6.5mm
Washer Outer Diameter: 18mm
Hex: 10mm
Hex Height: 7mm

Acura CL 2003 - 1997; ILX 2019 - 2013; Integra 2001 - 1986; Legend 1995 - 1987; MDX 2019 - 2014; NSX 2005 - 1991; RDX 2019 - 2007; RL 2012 - 2009; RLX 2019 - 2014; RSX 2004 - 2002; TL 2014 - 1996; TLX 2019 - 2015; TSX 2014 - 2004; Vigor 1994 - 1992; ZDX 2013 - 2010
Honda Accord 2020 - 1990; Civic 2020- 1984; CR-V 2020 - 1997; CR-Z 2016 - 2011; Crosstour 2015 - 2010; CRX 1991 - 1984; Element 2008 - 2007; Fit 2020 - 2007; Insight 2020 - 2000; Odyssey 2020 - 1995; Passport 2020 - 2019; Pilot 2020 - 2012; Prelude 2001 - 1992; Ridgeline 2020 - 2006

UNIT PACKAGE: 15



22941
(Acura & Honda: 90101-TR0-000)
Silver

Engine Cover Phillips Drive Bolt

Size: M6 - 1.0 x 8.5mm
Shoulder Diameter: 10mm
Shoulder Length: 4.5mm
Head Diameter: 18mm
Acura ILX 2015 - 2013
Honda Civic 2015 - 2012



UNIT PACKAGE: 15



22943
(Acura & Honda: 90674-TY2-A01)
Silver

Engine Cover

Slotted Truss Head Retainer Pin

Head Diameter: 20mm
Stem Length: 13mm
Acura ILX, RLX & TLX 2014 - On
Honda Accord, Civic & CR-V 2017 - On



UNIT PACKAGE: 15

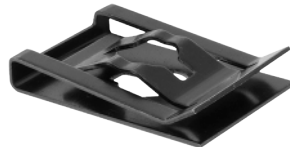

25262
(Honda: 90673-TY2-A01)
Black Phosphate

Engine Cover U-Nut

Panel Range: 3mm
Center of Hole To Edge: 15mm
Width: 20mm
Length: 32mm
Use with Auveco No. 22943
Acura ILX 2016 - On, RDX 2019 - On, RLX 2020 - 2014, TLX 2020 - 2015
Honda Accord 2014 - On, Civic, CR-V & Clarity 2017 - On, Insight 2019 - On

UNIT PACKAGE: 15



13225
Plated

U-Type Nut

Screw Size: 4.2mm (#8)
Width: 11mm
Length: 16.5mm
Panel Range: .5mm-2.5mm
Center of Hole to Edge: 8mm

UNIT PACKAGE: 50



22105
(90675-SA5-003)
Zinc

Metric Extruded U-Nut

Screw Size: M6-1.0
Panel Range: 2mm - 4mm
Center of Hole to Edge: 14.5mm (9/16")
Acura 2007 - 1998
Honda 2014 - 1983

UNIT PACKAGE: 25



22316
(85858-3S000)
Black Nylon

Interior Trim Clip
Overall Height: 16mm
Width at Bottom: 11mm
Hyundai Azera & Sonata and
Kia Optima & Soul 2011 - On

UNIT PACKAGE: 50



22317
(85859-3S100)
Black Nylon

Interior Trim Clip
Overall Height: 19mm
Width at Bottom: 15mm
Hyundai Accent, Azera, Elantra & Sonata
and Kia Optima & Rio 2011 - On

UNIT PACKAGE: 50



22007
(84747-2L000)
White Nylon

**Trim Panel &
Dash Console Clip**
Overall Length: 21mm
Hyundai Elantra, Entourage,
Sonata & Veloster 2006 - On
Kia Forte, Sorento & Soul 2010 - On

UNIT PACKAGE: 50



21038
(87719-3D000)
Natural Nylon

Body Side Moulding Clip
Head Size: 6mm x 14mm
Base Diameter: 14mm
Overall Height: 6mm
Elantra & Sonata 2004 - On

UNIT PACKAGE: 15



20567
(87756-38000)
Black Nylon

**Body Side Moulding
Clip with Sealer**
Top Head Size: 8mm x 9mm
Bottom Head Size: 14mm x 18mm
Stem Length: 10mm
Elantra & Sonata 2002 - On
Kia Rio 2010 - On

UNIT PACKAGE: 15



21312
(87756-2G000)
Black Nylon

Body Side Moulding Clip with Sealer
Head Size: 8mm x 22mm
Stem Length: 10mm
Hyundai Sonata and
Kia Magentis & Optima 2006 - On

UNIT PACKAGE: 15



22438
(Hyundai: 87715-3K000)
White Nylon

**Door Trim, Roof & Spoiler
Moulding Clip with Sealer**
Head Size: 9mm x 18.3mm
Stem Length: 10mm
Hyundai Azera, Equus, Genesis, Sonata,
Tucson & Veloster and Kia Soul 2006 - On

UNIT PACKAGE: 25



21064
(87758-35000)
Yellow Nylon

Rocker Moulding Clip with Sealer
Top Head Size: 10mm x 11mm
Bottom Head Size: 14mm x 19mm
Stem Length: 10mm
Accent, Santa Fe & Tiburon 1995 - On

UNIT PACKAGE: 15



22329
(87758-38000)
White Nylon

Rocker Moulding Clip with Sealer
Top Head Size: 10mm x 13mm
Bottom Head Size: 7mm x 16mm
Stem Length: 9mm
Hyundai Sonata 2001 - 1999
Kia Optima & Sorento 2009 - 2001

UNIT PACKAGE: 50



21863
(87758-35010)
White Nylon

Moulding Clip with Sealer
Top Head Size: 10mm x 12mm
Bottom Head Size: 14mm x 18mm
Stem Length: 10mm
Hyundai Accent, Kia Soul &
Mitsubishi Outlander 2006 - On

UNIT PACKAGE: 15

22015

(Hyundai: 87756-1F000, Kia: 87756-3R000)
Blue Nylon



Fender Flare, Rocker, Door & Exterior Moulding Clip with Sealer

Top Head Size: 10mm x 12mm
Bottom Head Size: 14mm x 20mm
Stem Diameter: 14mm
Stem Length: 10mm

G70 2022 - 2019, G90 2019 - 2017, GV70 2022, GV80 2022 - 2021, Elantra 2020 - 2017, Kona 2022 - 2018, Palisade 2022 - 2020, Santa Fe 2022 - 2013, Tucson 2021 - 2016, Veloster 2022 - 2019, Venue 2022 - 2020, Cadenza 2016 - 2014, Forte 2021 - 2020, Niro 2021 - 2017, Seltos 2022 - 2021, Soul 2019 - 2014, Sportage 2022 - 2005, Telluride 2022 - 2020, Sorento 2022 - 2021

UNIT PACKAGE: 25

22500

(Hyundai: 87756-3N100)
Yellow Nylon



Trunk Side Trim Moulding Clip with Sealer

Top Head Size: 12mm x 12mm
Bottom Head Size: 14mm x 18mm
Stem Diameter: 14.5mm
Stem Length: 16mm
Hyundai Equus 2015 - 2010



UNIT PACKAGE: 15

22331

(Hyundai: 87759-3V000)
Yellow Nylon



Rocker Panel Moulding Clip with Sealer

Top Head Size: 12mm x 12mm
Bottom Head Size: 14mm x 20mm
Stem Length: 17mm
Hyundai Azera 2012 - On
Kia K900 2015 - On



UNIT PACKAGE: 25

25423

(Hyundai & Kia: 87758-G2000, 87767-J9000)
White Nylon



Rocker Moulding Retainer with Sealer

Top Head Size: 6mm x 18mm
Bottom Head Size: 18mm x 32mm
Stem Size: 9mm x 13.5mm
Stem Length: 10mm
Overall Length: 16mm



Genesis GV70 2022, GV80 2022 - 2021
Hyundai Ioniq 2020 - 2017, Kona 2022 - 2018, Santa Fe 2020 - 2019, Palisade, Sonata 2020 - On
Kia K5 2021 - On, Telluride 2020 - On

UNIT PACKAGE: 15

22470

(Hyundai: 87716-2W000)
White Nylon



Fender, Body Side & Rocker Moulding Clip with Sealer

Top Head Size: 10mm x 12mm
Bottom Head Size: 14mm x 20mm
Stem Length: 11mm
Hyundai Santa Fe 2012 - On
Kia Borrego 2011 - 2007 &
Kia Niro 2017 - On

UNIT PACKAGE: 50

22020

(87770-27000)
White Nylon



Rocker Moulding Clip with Sealer

Top Head Size: 12mm x 15mm
Bottom Head Size: 14mm x 36mm
Stem Diameter: 14mm
Stem Length: 10mm
Hyundai Tiburon 2001 - 1997

UNIT PACKAGE: 25

22019

(87758-39000)
White Nylon



Rocker Moulding Clip with Sealer

Top Head Size: 16mm x 20mm
Bottom Head Size: 14mm x 18mm
Stem Diameter: 13mm
Stem Length: 10mm

Hyundai Azera, Tiburon & XG300/350 2011 - 01

UNIT PACKAGE: 25

20568

(87758-3D000)
Yellow Nylon



Rocker Panel Clip with Sealer

Top Head Size: 16mm x 20mm
Bottom Head Size: 14mm x 18mm
Stem Length: 10mm
Elantra & Sonata 2002 - On

UNIT PACKAGE: 15

22314

(85815-24100)
Gray Nylon



Rocker Panel Moulding Clip

Top Head Size: 12mm x 14mm
Bottom Head Diameter: 17mm
Stem Length: 12mm
Fits into 8mm Hole
Hyundai Scoupe 1995 - 1991

UNIT PACKAGE: 25



21244
(87702-H1000)
White Nylon

Rocker Moulding Clip with Sealer
Top Head Size: 11mm x 15.5mm
Bottom Head Diameter: 16mm
Stem Length: 12mm
Hyundai Genesis & Sonata
and Kia Sorento 2009 - On

UNIT PACKAGE: 15



22013
(87703-H1000)
Yellow Nylon

Hood Moulding Clip with Sealer
Top Head Size: 12mm x 16mm
Bottom Head Diameter: 16mm
Stem Diameter: 9.5mm
Stem Length: 10mm
Hyundai Elantra 2006 - 01

UNIT PACKAGE: 25



22018
(87756-37000)
White Nylon

Rocker Moulding Clip with Sealer
Top Head Size: 16mm x 20mm
Bottom Head Diameter: 15mm
Stem Length: 10mm
Fits into 9mm Hole
Hyundai Sonata 2005 - 02

UNIT PACKAGE: 25



21136
(87756-2E000)
White Nylon

Moulding Clip with Sealer
Top Head Size: 10mm x 12mm
Bottom Head Size: 14mm x 20mm
Stem Length: 10mm
Hyundai Entourage, Tucson & Veracruz and Kia
Optima, Sedona, Spectra & Sportage 2005 - On

UNIT PACKAGE: 15

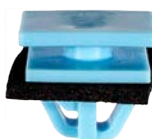

22327
(Hyundai: 87756-D3000)
Blue Nylon

Door Moulding Clip with Sealer
Top Head Size: 14mm x 18mm
Bottom Head Size: 16mm x 20mm
Stem Length: 10mm
Hyundai Tucson 2016 - On

UNIT PACKAGE: 25



21321
(87758-3L000)
Blue Nylon

Moulding Clip with Sealer
Top Head Size: 16mm x 18mm
Bottom Head Size: 18mm x 20mm
Stem Length: 15mm
Hyundai Azera & Genesis 2009 - On

UNIT PACKAGE: 15



22328
(Hyundai: 87758-2S000)
White Nylon

Rocker Moulding Clip with Sealer
Head Size: 17mm x 25mm
Stem Length: 14mm
Hyundai Tucson 2016 - On

UNIT PACKAGE: 25



22330
(Hyundai: 87759-2M000)
Red Nylon

Rocker Panel Moulding Clip with Sealer
Head Size: 17mm x 25mm
Stem Length: 13mm
Hyundai Genesis 2008 - On

UNIT PACKAGE: 50



25422
(Hyundai & Kia: 14202-14120-B)
Yellow Nylon

Rocker Moulding Clip with Sealer
Top Head Size: 16mm x 18mm
Bottom Head Size: 18mm x 20mm
Stem Size: 12mm x 15mm
Stem Length: 16mm
Fits into 13mm Hole
Panel Range: 1.5mm
Genesis G80 2021 - On,
Hyundai Sonata 2021 - 2020; Kia K5 2021

UNIT PACKAGE: 25



25423
(Hyundai & Kia: 87758-G2000,
87767-J9000)
White Nylon

Rocker Moulding Retainer with Sealer
Top Head Size: 6mm x 18mm
Bottom Head Size: 18mm x 32mm
Stem Size: 9mm x 13.5mm
Stem Length: 10mm
Overall Length: 16mm
Genesis GV70 2022, GV80 2022 - 2021
Hyundai Ioniq 2020 - 2017, Kona 2022 - 2018,
Santa Fe 2020 - 2019, Palisade, Sonata 2020 - On
Kia K5 2021 - On, Telluride 2020 - On

UNIT PACKAGE: 15



22938
(Hyundai: 87767-B1000)
White Nylon

Rocker Moulding Clip
Width: 25mm
Length: 25mm
Stem Length: 12.5mm
Fits into 12mm Hole
Hyundai Genesis & Genesis
G80 2018 - 2014

UNIT PACKAGE: 50



22135
(83219-22000)
White Nylon

Belt Moulding Weatherstrip Clip
Width: 18.3mm
Length: 29mm
Hyundai Accent 2005 - 1995

UNIT PACKAGE: 25



22590
(Hyundai: 86143-3S000)
White Nylon

Windshield Moulding Clip
Overall Length: 60mm
Hyundai Sonata 2015 - 2011

UNIT PACKAGE: 25



22561
(Hyundai: 87715-3V000)
White Nylon



Waist Line Moulding Trim Clip
Head Size: 8mm x 10mm
Stem Size: 8mm x 10mm
Stem Length: 8mm
Hyundai Azera, Genesis, Genesis G80,
Sonata & Sonata Hybrid 2011 - On

UNIT PACKAGE: 25



22565
(Hyundai: 87715-3S000)
White Nylon



Waist Line Moulding Trim Clip with Sealer
Head Size: 5mm x 14mm
Stem Size: 5mm x 11mm
Stem Length: 9mm
Hyundai Sonata & Sonata Hybrid 2009 - On

UNIT PACKAGE: 25



22322
(86518-3M000)
White Nylon



Bumper Grommet
Screw Size: M3.5 (#6)
Head Size: 8mm x 10mm
Stem Length: 12mm
Hyundai Azera & Sonata 2012 - On
Kia Cadenza 2014 - On

UNIT PACKAGE: 25



22564
(Hyundai: 14910-04000, 92561-25000)
Natural Nylon

License Plate Grommet
Screw Size: M3.5 (#6)
Head Diameter: 12mm
Stem Length: 7mm
Overall Height: 9mm
Hyundai Accent, Azera, Elantra, Entourage,
Excel, Ioniq, Santa Fe, Scoupe, Tiburon, Tucson, Veloster,
XG300 & XG350 1985 - On; Kia Optima & Rio 2016 - 2010

UNIT PACKAGE: 25



22323
(Kia: 86625-1M000)
White Nylon



Bumper Grommet
Screw Size: M4.8 (#10)
Head Size: 8mm x 10mm
Stem Length: 12mm
Kia Optima 2011 - On

UNIT PACKAGE: 25



21068
(86848-22000, 86848-C8000,
86848-25000, 86848-3W000)
Black Nylon



Fender Apron, Rocker Molding Nylon Nut
Screw Size: M4.8 (#10)
Head Diameter: 16mm
Stem Length: 11mm
Fits into 8.5mm Square Hole
Genesis G70 2021 - 2019, GV70 2022, GV80 2022 - 2021,
Hyundai Accent 2022 - 1995, Azera 2017 - 2006,
Elantra 2020 - 2001, Entourage 2008 - 2007,
Equus 2016 - 2011, Genesis 2014 - 2009,
Ioniq 2022 - 2017, Kona 2022 - 2018,
Palisade, Venue 2022 - 2020, Santa Fe 2022 - 2010,
Sonata 2021 - 1999, Tiburon 2008 - 1997,
Tucson 2022 - 2005, Veloster 2022 - 2012,
Veracruz 2012 - 2007, Kia Amanti 2009 - 2007,
Cadenza 2016 - 2014, Carnival 2022,
Forte, Soul 2021 - 2010, K5, Seltos 2022 - 2021,
Niro 2021 - 2017, Niro 2021 - 2017, Optima 2020 - 2019,
Rio 2021 - 2006, Sedona 2014 - 2006,
Sorento 2022 - 2011, Spectra 2009 - 2004,
Sportage 2005 - On, Stinger 2021 - 2018,
Telluride 2022 - 2020

UNIT PACKAGE: 25



21150
(14913-05000, 14913-05010)
White Nylon

Front & Rear Bumper and Fender Nylon Nut
Screw Size: M4.8 (#10)
Head Size: 12mm x 12mm
Stem Length: 11mm
Hyundai Accent 2006 - 1994, Azera 2016 - 2005,
Tiburon 2001 - 1996, Veracruz 2012 - 2006,
Elantra 2015 - 1991, Sonata 1993 - On, XG300 2001- 2000,
XG350 2005 - 2002; Kia Magentis 1992 - On,
Forte 2016 - 2010, Forte5 2018 - 2014, K900 2020 - 2019,
Optima 2020 - 2017, Sedona 2015 - On,
Sorento 2016 - On

UNIT PACKAGE: 25



22300
(14910-05000)
Natural Nylon

Door Handle Nylon Nut
Screw Size: M4.2 (#8)
Head Size: 12mm x 12mm
Stem Length: 9mm
Overall Height: 10mm

Hyundai Accent, Azera, Elantra, Equus, Genesis, Santa Fe, Sonata, Tucson & Veloster 2014 - On

UNIT PACKAGE: 25



21069
(92351-37000)
Natural Nylon

Headlight Assembly Grommet
Head Diameter: 15mm
Stem Length: 8mm
Fits into 10mm Hole
XG300/350 2001 - On
Kia 2000 - On

UNIT PACKAGE: 25



20566
(87756-3D000)
White Nylon

Body Side Moulding Clip with Sealer
Screw Size: M4.2 (#8)
Head Size: 14mm x 14mm
Stem Length: 10mm
Elantra & Sonata 2002 - On

UNIT PACKAGE: 15



22508
(Hyundai: 87756-2J000)
Pink Nylon

Side Garnish Moulding Clip with Sealer
Head Size: 13mm x 16mm
Stem Diameter: 11.5mm
Stem Length: 9mm
Hyundai Santa Fe & Tucson 2013 - On

UNIT PACKAGE: 15



21356
(Hyundai: 87714-FD200;
Kia: 87756-1C000)
White Nylon

Body Side Moulding Clip
Screw Size: M4.2 (#8)
Head Size: 13mm x 13mm
Stem Length: 10mm
Hyundai Veracruz and
Kia Rio 2009 - On

UNIT PACKAGE: 15



22324
(87701-3B000)
Natural Nylon

Body Side Moulding Retainer
Top Size: 16mm x 20mm
Bottom Size: 16mm x 16mm
Screw Size: M3.5 (#6)
Hyundai Tucson 2009 - 2004

UNIT PACKAGE: 50



22563
(Hyundai: 86699-1E010)
Gray Nylon

Bumper Screw Grommet
Screw Size: M4.8 (#10)
Head Size: 12mm x 12mm
Stem Length: 8mm
Overall Height: 10mm
Hyundai Accent, Tucson & Veloster 2009 - On
Kia Optima & Optima Hybrid 2013 - 2010

UNIT PACKAGE: 25



22017
(87756-34520)
Green Nylon

Fender & Door Moulding Clip
Screw Size: M3.5 (#6)
Head Size: 13mm x 13mm
Stem Diameter: 13.5mm
Stem Length: 8mm
Hyundai Tucson 2009 - 05
Kia Optima 2006 - 01

UNIT PACKAGE: 50



22016
(87756-26900)
White Nylon

Emblem & Rocker Moulding Clip with Sealer
Screw Size: M3.5 (#6)
Head Size: 13mm x 13mm
Stem Diameter: 12mm
Stem Length: 10mm
Hyundai Genesis & Santa Fe 2007 - On

UNIT PACKAGE: 50



21066
(87758-37000)
White Nylon

Fender & Rocker Moulding Nylon Nut with Sealer
Screw Size: M4.2 (#8)
Head Size: 17mm x 17mm
Stem Length: 14mm
Hyundai Accent & Sonata 1999 - On
Kia 2001 - On

UNIT PACKAGE: 25



22562
(Hyundai: 86625-1E000)
White Nylon

Bumper Bracket Screw Grommet with Sealer
Screw Size: M4.8 (#10)
Top Head Size: 14mm x 18mm
Bottom Head Diameter: 18mm
Stem Size: 8.5mm x 8.5mm
Stem Length: 18mm
Hyundai Elantra GT 2013 - On
Kia Niro & Sorento 2016 - On

UNIT PACKAGE: 25



22557
(Hyundai: 97519-22000)
White Nylon

Bumper & Side Marker Lamp Screw Grommet With Sealer
Screw Size: M3.5 (#6)
Head Diameter: 14mm
Stem Length: 16mm
Fits Into 7mm x 7mm Hole
Hyundai Accent, Elantra, Excel, Santa Fe, Scoupe, Sonata, Tiburon, Tucson & Veloster 1985 - On

UNIT PACKAGE: 50



22563
(Hyundai: 86699-1E010)
Gray Nylon

Bumper Screw Grommet
Screw Size: M4.8 (#10)
Head Size: 12mm x 12mm
Stem Length: 8mm
Overall Height: 10mm
Hyundai Accent, Tucson & Veloster 2009 - On
Kia Optima & Optima Hybrid 2013 - 2010

UNIT PACKAGE: 25



22011
(86625-3S000)
White Nylon

Bumper Cover Screw Grommet with Sealer
Screw Size: M4.8 (#10)
Top Head Size: 14mm x 18mm
Bottom Head Diameter: 18mm
Stem Length: 18mm
Hyundai Santa Fe 2013 - On

UNIT PACKAGE: 25



22297
(87759-3S000)
Gray Nylon

Rocker & Exterior Trim Moulding Grommet with Sealer
Screw Size: M4.2 (#8)
Head Size: 16.5mm x 16.5mm
Stem Diameter: 12.5mm
Stem Length: 12mm
Overall Height: 15mm
Hyundai Azera & Sonata 2011 - On

UNIT PACKAGE: 10



22591
(Hyundai: 82134-3L000)
Black Nylon

Weatherstrip Clip
Width: 12mm
Length: 18mm
Black Nylon
Hyundai Azera, Elantra, Equus, Genesis, Santa Fe & Sonata and Kia Optima & Sedona 2017 - 2005

UNIT PACKAGE: 50



21292
(87759-27000)
Yellow Nylon

Rocker Moulding Grommet with Sealer
Screw Size: M4.2 (#8)
Head Size: 17mm x 25mm
Stem Length: 16mm
Accent, Genesis, Santa Fe, Sonata, Tiburon & Veracruz 1995 - On

UNIT PACKAGE: 15



22558
(Hyundai: 82134-22000)
Black Nylon

Door Weatherstrip Clip
Height: 14mm
Length: 20mm
Hyundai Accent, Elantra, Santa Fe, Sonata, Tucson & Veloster 1993 - On;
Kia Forte 2017 - 2014

UNIT PACKAGE: 25



21232
(86910-21010)
Natural Nylon

Bumper Screw Grommet with Sealer
Screw Size: M4.8 (#10)
Head Diameter: 18mm
Stem Length: 21mm
Azera 2009 - On

UNIT PACKAGE: 15



22526
(Hyundai: 82133-37000)
Red Nylon

Weatherstrip Retainer
Head Size: 5mm x 13mm
Stem Diameter: 5.5mm
Stem Length: 6mm
Hyundai Accent, Elantra, Santa Fe & Sonata 2006 - 1993

UNIT PACKAGE: 50



22321
(86438-2T000)
Black Nylon

Hood & Bumper Seal Retainer
Head Size: 4.5mm x 13mm
Stem Diameter: 7.6mm
Stem Length: 7.5mm
Hyundai Elantra & Genesis 2013 - On
Kia K900 & Optima 2011 - On

UNIT PACKAGE: 50



21381
(86438-4A100)
Black Nylon

Hood Seal Retainer
Head Size: 5mm x 13mm
Stem Diameter: 8mm
Stem Length: 11mm
Hyundai Elantra & Tucson and
Kia Forte & Sportage 2009 - On

UNIT PACKAGE: 50



21382
(86434-4A000)
Black Nylon

Hood Seal Retainer
Head Size: 6mm x 16mm
Stem Diameter: 8mm
Stem Length: 14mm
Hyundai Elantra, Sonata &
Tucson and Kia Sportage 2009 - On

UNIT PACKAGE: 50



22320
(86438-1R000)
Black Nylon

Hood Seal Retainer
Head Size: 5mm x 13mm
Stem Diameter: 8mm
Stem Length: 10mm
Hyundai Accent 2011 - On

UNIT PACKAGE: 50



22325
(87756-2W000)
Red Nylon

Weatherstrip Retainer
Head Size: 5mm x 15mm
Stem Diameter: 7mm
Stem Length: 8mm
Hyundai Santa Fe & Kia Sorento 2013 - On

UNIT PACKAGE: 100



22337
(82132-27100)
White Nylon

Door Weatherstrip Retainer
Top Head Size: 5mm x 15mm
Bottom Head Diameter: 9.3mm
Stem Diameter: 7mm
Stem Length: 11mm
Hyundai Azera, Santa Fe & Sonata 2001 - On,
Tucson 2021 - On

UNIT PACKAGE: 25



20543
(81126-37010)
Black Nylon

Hood Insulation Retainer
Head Diameter: 26mm
Stem Diameter: 12mm
Stem Length: 14mm
Hyundai Elantra & Sonata
and Kia Optima 1995 - On

UNIT PACKAGE: 15



22318
(86179-2V000)
White Nylon



Garnish Moulding Retainer with Sealer
Top Head Size 13mm x 13mm
Bottom Head Diameter: 20mm
Stem Length: 11mm
Fits into 7.5mm Hole
Hyundai Veloster 2012 - On

UNIT PACKAGE: 25



22319
(86179-2V020)
Blue Nylon



Garnish Moulding Retainer with Sealer
Top Head Size: 10.5mm x 12mm
Bottom Head Diameter: 12mm
Stem Length: 11mm
Fits into 7.5mm Hole
Hyundai Veloster 2012 - On
Kia Soul 2014 - On

UNIT PACKAGE: 25



22370
(Hyundai: 92485-2H000)
White Nylon



Rear Lamp Moulding Retainer with Sealer
Top Head Diameter: 17mm
Bottom Head Diameter: 15mm
Stem Length: 11mm
Fits into 6mm Hole
Hyundai Accent, Elantra, Equus,
Genesis, Genesis Coupe, Santa Fe,
Sonata, Veloster & Veracruz
and Kia Forte, Optima, Rio
& Sportage 2007 - On

UNIT PACKAGE: 15



22592
(Hyundai: 85818-37000)
White Nylon

Moulding Clip With Sealer

Top Head Size: 12.5mm x 14mm
Bottom Head Diameter: 16mm
Stem Diameter: 10mm
Stem Length: 12.5mm
Hyundai Accent, Elantra & Tucson and
Kia Optima & Rio
2012 - On

UNIT PACKAGE: 25



22003
(82315-2P000)
White Nylon

Trim Panel Retainer

Top Head Diameter: 13mm
Middle Head Diameter: 15mm
Bottom Head Diameter: 18mm
Stem Diameter: 11mm
Stem Length: 13mm
Overall Length: 19mm
Hyundai & Kia 1999 - On

UNIT PACKAGE: 50



22009
(85506-4A000)
White Nylon

Trim Panel & Window Garnish Retainer

Top Head Diameter: 13mm
Middle Head Diameter: 16mm
Bottom Head Diameter: 15mm
Stem Diameter: 9.6mm
Stem Length: 13mm
Overall Length: 20mm
Hyundai Tucson & Kia Sorento 2003 - On

UNIT PACKAGE: 50



22006
(82315-36000,
92552-36000)
White Nylon

Trim Panel Retainer with Sealer

Top Head Diameter: 13mm
Middle Head Diameter: 15mm
Bottom Head Diameter: 18.5mm
Stem Diameter: 10.3mm
Stem Length: 15mm
Overall Length: 21mm
Hyundai Accent & Elantra 2000 - 1995

UNIT PACKAGE: 25



21070
(Hyundai: 82315-38000
GM: 94530565)
White Nylon

Trim Panel Retainer

Top Head Diameter: 13mm
Middle Head Diameter: 16mm
Bottom Head Diameter: 16mm
Stem Diameter: 9.5mm
Stem Length: 10mm
Overall Length: 18mm
Chevrolet 2004 - On
Hyundai Accent, Santa Fe,
Sonata Tiburon & XG300/350 1999 - On
Kia 2001 - On

UNIT PACKAGE: 25



21360
(85849-3B000)
White Nylon

Headliner & Trim Panel Retainer

Top Head Diameter: 13mm
Middle Head Diameter: 16mm
Bottom Head Diameter: 16mm
Stem Diameter: 10mm
Stem Length: 12mm
Overall Length: 19.5mm
Hyundai 2001 - On



UNIT PACKAGE: 25



22313
(82315-2W000)
Green Nylon

Door Panel, Interior Trim & Garnish Retainer

Top Head Diameter: 13mm
Middle Head Diameter: 16mm
Bottom Head Diameter: 18mm
Stem Diameter: 10mm
Stem Length: 10mm
Hyundai Santa Fe & Sonata 2013 - On
Kia Forte & K900 2014 - On



UNIT PACKAGE: 25



22004
(82315-22000)
White Nylon

Trim Panel Retainer

Top Head Diameter: 13mm
Middle Head Diameter: 16mm
Bottom Head Diameter: 18mm
Stem Diameter: 9mm
Stem Length: 15mm
Overall Length: 20mm
Hyundai Accent 1999 - 95

UNIT PACKAGE: 50



22008
(85495-2E050)
Black Nylon

Headliner Retainer
Top Head Diameter: 14mm
Middle Head Diameter: 15mm
Bottom Head Diameter: 16mm
Stem Diameter: 10.3mm
Stem Length: 10mm
Overall Length: 15.5mm
Hyundai & Kia

UNIT PACKAGE: 50



21188
(82315-27000)
Pink Nylon

Trim Panel Retainer
Top Head Diameter: 15mm
Middle Head Diameter: 16mm
Bottom Head Diameter: 18mm
Stem Diameter: 10mm
Stem Length: 12mm
Hyundai and Kia 2003 - On

UNIT PACKAGE: 15



22315
(85849-3L000)
Gray Nylon

Garnish & Interior Moulding Retainer
Top Head Diameter: 13mm
Middle Head Diameter: 16.5mm
Bottom Head Diameter: 18mm
Stem Length: 15mm
Fits into 9mm Hole
Hyundai Azera, Sonata
& Tuscon 2006 - On
Kia Forte 2010 - On

UNIT PACKAGE: 50



22005
(82315-33020)
White Nylon

Trim Panel Retainer
Top Head Diameter: 15mm
Middle Head Diameter: 16mm
Bottom Head Diameter: 18mm
Stem Diameter: 10.7mm
Stem Length: 12mm
Overall Length: 18.5mm
Hyundai & Kia 1995 - On

UNIT PACKAGE: 50



21233
(86157-37000)
Black Nylon

Hood Mounting Push-Type Retainer
Head Diameter: 10mm
Stem Length: 13mm
Fits into 5mm Hole
Azera 2009 - On

UNIT PACKAGE: 15



21328
(86155-2H100)
Black Nylon

Cowl & Bumper Push-Type Retainer
Head Diameter: 15mm
Stem Length: 10mm
Fits into 7mm Hole
Hyundai Genesis & Veracruz and Kia Rio 2009 - On

UNIT PACKAGE: 15



21530
(Subaru: 909130067;
Hyundai: 86590-3S000)
Black Nylon

Engine Cover and Fender Liner Push-Type Retainer
Head Diameter: 18mm
Stem Length: 10mm
Fits into 8mm Hole
B9 Tribeca, Forester, Legacy & Outback
& Tribeca. 2005 - On, Hyundai Azera, Elantra, Genesis & Sonata and Kia Cadenza & Optima 2011 - On

UNIT PACKAGE: 15



17632
(Mazda: B092-51-833;
Ford: MB-455-56143, W705845-S300;
Hyundai: 86590-28000)
Black Nylon

Push-Type Retainer
Head Diameter: 18mm
Stem Length: 12mm
Fits into 8mm Hole
Hyundai, Mazda & Ford Aspire

UNIT PACKAGE: 10



22253
(86595-2T500,
14206-08250-B)
Black Nylon

Bumper, Engine Under Cover & Fender Liner Push-Type Retainer
Head Diameter: 18mm
Stem Length: 14mm
Fits into 8mm Hole
Hyundai Elantra, Equus, Genesis,
Santa Fe & Sonata and Kia Forte, K900,
Optima, Sedona & Sorento 2013 - On

UNIT PACKAGE: 15



22505
(Hyundai: 86825-26000)
Black Nylon

Rear Fender Liner Plug
Head Diameter: 30mm
Overall Height: 16.5mm
Hyundai Accent, Equus,
Genesis, Santa Fe,
Tucson & Veracruz 2011 - On
Kia Sorento 2016 - 2011

UNIT PACKAGE: 15



22435

(Hyundai: 84219-3L000)
Black Nylon

**Engine Under Cover &
Rear Bumper Moulding Grommet**

Screw Size: M6-1.0
Head Diameter: 20mm
Stem Diameter: 14mm
Stem Length: 7mm
Overall Length: 9.5mm

Hyundai Azera, Equus, Genesis, Santa Fe & Sonata and
Kia Forte, Optima & Rio 2010 - On

UNIT PACKAGE: 25

21355

(Not Available from O.E.M.)
Black Nylon



Photo not actual size

Cable Strap

Overall Length: 160mm (6-3/8")
Strap Width: 5mm (3/16")
Maximum Bundle Diameter: 36mm (1-13/32")
Fits into: 7mm Hole
Hyundai & Universal

UNIT PACKAGE: 25



21067

(86593-24000)
Stainless Steel

Bumper & Grille Retainer

Width: 13mm
Length: 30mm
Accent, Santa Fe & Sonata 1995 - On

UNIT PACKAGE: 25



22352

(84145-26000)
Black Nylon

**Wheel Well Liner &
Splash Shield Nylon Nut**

Hex Size: 14mm
Flange Diameter: 30mm
Overall Height: 10mm

Hyundai Accent, Elantra, Equus,
Genesis, Genesis Coupe, Genesis
G90, Santa Fe, Sonata, Tucson,
Veloster & Veracruz 2000 - On

UNIT PACKAGE: 15



21378

(86825-28000)
Black Nylon

Nylon U-Nut

Screw Size: M6 (#14)
Panel Size: Up to 1.5mm
Center of Hole to Edge: 8mm

Hyundai Accent & Elantra and Kia 1995 - On

UNIT PACKAGE: 25

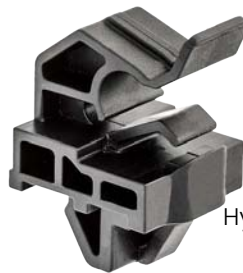

22506

(Hyundai: 81174-2L000)
Black Nylon

Hood Prop Rod Clip

Width: 20mm
Length: 24mm
Holds 8mm Rod

Hyundai Accent & Elantra 2008 - On
Kia Forte & Soul 2013 - 2009

UNIT PACKAGE: 15



25198

(Hyundai & Kia: 81199-38000)
Black Nylon

Hood Release Cable Clip

Holds 7mm Dia. Tube/Cable
Fits into 8mm Hole

Overall Height: 19.7mm

Hyundai Accent, Veloster 2011 - On;
Elantra 2015 - On; Genesis 2019 - On;
Ioniq 2017 - On; Kona 2018 - On;
Nexo 2019 - On; Venue 2020 - On;
Kia Seltos & Soul 2019 - 2010;
Sportage 2011 - On

UNIT PACKAGE: 25



25199

(Hyundai & Kia: 81199-33000)
Black Nylon

Hood Release Cable Clip

Holds 7mm Dia. Tube/Cable
Fits into 8mm Hole

Overall Height: 19mm

Hyundai Accent 2005 - 1995;
Azera 2017 - 2006; Elantra 1992 - On;
Entourage 2008 - 2007;
Equus 2016 - 2011; Genesis 2016 - On;
Palisade 2020 - On; Santa Fe 2012 - 2001;
Scoupe 2001 - 1991; Sonata 1995 - On;
Tiburon 2008 - 1997; Tucson 2005 - On;
Veracruz 2012 - 2007; XG300 2001;
XG350 2005 - 2002; Kia Borrego 2009;
Cadenza 2014 - On; Forte 2018 - 2014;
K5 2021 - On; K900 2015 - On; Niro 2017 - On;
Optima 2001 - On; Roi 2018 - 2012;
Sedona 2014 - 2006; Sorento 2011 - On;
Sportage 2005 - On; Stinger 2018 - On;
Telluride 2020 - On

UNIT PACKAGE: 25



22507

(Hyundai: 81174-21000,
81174-11011 & 81174-21010)
Black Nylon

Hood Prop Rod Clip

Holds 8mm Rod

Bottom Base Size: 20mm x 20mm

Stem Length: 9mm

Overall Length: 25mm

Hyundai Elantra, Sonata,
Tucson & Veloster 1997 - On

UNIT PACKAGE: 15





22301

(Nissan: 01553-05233)
Black Nylon

Fender Liner Moulding Clip

Top Width: 31mm
Bottom Width: 30mm
Overall Height: 11mm
Infiniti JX35 & QX60 2013 - On
Nissan Altima, Murano, Pathfinder,
Rogue & Sentra 2007 - On

UNIT PACKAGE: 25



20961

(Not Available from O.E.M.)
White Nylon

**Drip Moulding Clip
with Sealer**

Top Width: 25mm
Overall Height: 16mm
Fits into 5mm Hole
Infiniti M45, I30 & G35 2005 - On
Nissan Altima, Maxima & 350Z 2002 - On

UNIT PACKAGE: 15



22076

(Nissan: 76882-6P010)
Natural Nylon

**Hood, Front Fender Bracket
& Exterior Moulding Clip**

Top Head Size: 15mm x 15mm
Bottom Head Size: 15mm x 15mm
Stem Length: 15mm
Overall Length: 22mm
Infiniti Q45 2001 - 1996
Nissan Altima & Maxima 2006 - 02

UNIT PACKAGE: 25



20886

(76882-6P000)
White Nylon

Moulding Clip

Top Head Size: 8mm x 15mm
Bottom Head Diameter: 15mm
Stem Length: 9mm
Infiniti 2005 - On

UNIT PACKAGE: 25



22061

(Nissan: 76882-JG10A)
White Nylon

**Fender Moulding Clip
with Sealer**

Top Head Size: 6mm x 12mm
Bottom Head Diameter: 16mm
Stem Length: 10mm
Infiniti Qx80 2014 - On
Nissan Juke 2011 - On

UNIT PACKAGE: 25



21147

(85284-AD000)
White Nylon

Rear Bumper Clip

Width: 20mm
Height: 29mm
Length: 35mm
Infiniti G20, I30, I35, Q45 & QX56
and Nissan 350Z, Altima, Maxima &
Murano 1999 - On

UNIT PACKAGE: 10



22218

(85284-EG000)
Yellow Nylon

Rear Bumper Clip

Width: 20mm
Length: 32mm
Overall Height: 25mm
Nissan GT-R and Infiniti G,
Q40, FX & QX70 2009 - On

UNIT PACKAGE: 15



21850

(Nissan: 26398-ED000)
White Nylon

Tail Light Clip

Top Head Size: 13mm x 13mm
Bottom Head Diameter: 19mm
Stem Length: 10mm
Infiniti M37, M56 & M Hybrid 2013 - On
Nissan Armada, Juke, Pathfinder,
Sentra & Versa 2006 - On

UNIT PACKAGE: 25



21160

(85284-7S610)
Black Nylon

Rear Bumper Retainer with Sealer

Head Diameter: 12mm
Stem Length: 21mm
Overall Length: 35mm
Infiniti QX56 and Nissan
Armada & Pathfinder 2004 - On

UNIT PACKAGE: 15



22261

(Nissan: 76848-35F00)
White Nylon

Moulding Screw Grommet with Sealer

Head Diameter: 18mm
Stem Diameter: 8.5mm
Stem Length: 14mm
Infiniti G35, G37, I30, I35, M35h, Q40, Q50,
Q70, QX56 & QX80 and Nissan 350Z, Altima,
Cube, Pathfinder & Sentra 2003 - On

UNIT PACKAGE: 15



22274

(Nissan: 01281-01121)
White Nylon

Screw Grommet with Sealer

Screw Size: 2.9mm (#4)
Head Diameter: 12mm
Stem Length: 16mm

Fits into 7mm x 7mm Square Hole
Infiniti M35h, M45, Q45 & QX50 and Nissan
Altima, Maxima, Pathfinder, Quest, Rogue &
Sentra 2012 - 2003

UNIT PACKAGE: 10



20764

(01281-00831)
Natural Nylon

**Bumper, Fender & Light
Screw Grommet**

Screw Size: M4.2 (#8)
Head Diameter: 16mm
Stem Length: 10mm

Fits into 9mm x 9mm Hole
Infiniti and Nissan 240SX, Altima, Frontier, Maxima,
Pathfinder, Quest & Xterra 1989 - On

UNIT PACKAGE: 25



21324

(01281-00691)
Natural Nylon

Screw Grommet with Sealer

Screw Size: M4.2 (#8)
Head Diameter: 16mm
Stem Length: 20mm

Nissan 240SX, Altima, Frontier,
Maxima, Pathfinder & Titan and
Infiniti I30, I35 & Q45 1989 - On

UNIT PACKAGE: 15



20604

(01281-00711)
Natural Nylon

Rocker Moulding Screw Grommet

Screw Size: M4.2 (#8) & #10 (M4.8)
Head Diameter: 20mm
Stem Length: 15mm

Nissan & Infiniti 1995 - On, NV200 2013 - On

UNIT PACKAGE: 10



21768

(Nissan: 63846-5V000)
White Nylon

Bumper Grommet with Sealer

Screw Size: M4.8 (#10)
Head Diameter: 20mm
Stem Length: 16mm
Overall Length: 22mm

Infiniti FX35, FX45, JX35, M35, M36, M37, M56 & QX56 and
Nissan Altima, Juke, Maxima, Murano,
Quest & Sentra 2003 - On

UNIT PACKAGE: 25



22766

(Nissan: 85099-1EA0A)
Yellow Nylon

Bumper Screw Grommet

Screw Size: M5
Head Diameter: 14mm
Stem Length: 15.5mm
Overall Length: 18.5mm

Infiniti Q50 & QX80 2014 - On QX56 2013 - 2011
Nissan 370Z 2009 - On, Armada & Quest 2017 - On

UNIT PACKAGE: 25



21824

(Nissan: 26557-2U001)
Brown Nylon

Screw Grommet with Sealer

Screw Size: M6.3-1.81 (#14)
Head Size: 15mm x 19mm
Stem Length: 16mm

Infiniti EX35, G37, JX35, M35, M45, Q50, QX56, QX60 &
QX70 and Nissan 350Z, 370Z, Altima, Armada, Cube,
Juke, Maxima, Murano, Pathfinder, Quest, Rouge, Sentra,
Versa & Xterra 2014 - 02

UNIT PACKAGE: 15



21111

(01281-00331)
Natural Nylon

**Bumper, Rocker Panel & Light Mounting
Screw Grommet with Sealer**

Screw Size: M6.3 (#14)
Head Diameter: 20mm
Stem Length: 16mm

Fits into 10mm Square Hole
Infiniti 1997 - On Nissan 1996 - On

UNIT PACKAGE: 25



21688

(01553-02923)
White Nylon

**Moulding, Door Sill Plate
Grommet with Sealer**

Head Size: 14mm x 18mm
Stem Length: 13mm

Infiniti M45 & Q45 and Nissan Armada,
Frontier, Pathfinder & Xterra 1996 - On;
NV200 2013 - On

UNIT PACKAGE: 25



20736

(01281-01081)
Natural Nylon

Front Bumper Nylon Nut

Screw Size: M4.8 (#10)
Flange Diameter: 16mm
Overall Length: 22mm

Infiniti & Nissan 1997 - On

UNIT PACKAGE: 15



22287

(Nissan: 62319-AU000)
Black Nylon

Front Bumper & Grille Screw Grommet

Head Size: 13.5mm x 23.5mm
Stem Length: 13mm
Overall Height: 15mm

Infiniti G37, M35, M45, QX56 &
QX80 and Nissan Rogue 2006 - On

UNIT PACKAGE: 15



22255

(Nissan: 76848-ED000)
Light Blue Nylon

Rocker & Door Trim Panel Grommet
Head Diameter: 15mm
Stem Diameter: 8mm
Stem Length: 15mm
Infiniti Q60 Coupe and Nissan 350Z &
Versa 2014 - 2006

UNIT PACKAGE: 25



22060

(Nissan: 65810-K2002)
Black Nylon

Hood Seal Retaining Clip
Head Size: 6.5mm x 16mm
Stem Diameter: 3.5mm x 5.5mm
Stem Length: 8mm
Infiniti 2003 - 1997; Nissan 2003 - 1996

UNIT PACKAGE: 25



21229

(65810-K2000)
Black Nylon

Hood Sealer Retaining Clip
Head Size: 6.4mm x 16mm
Stem Diameter: 3.5mm x 6mm
Stem Length: 10mm
Infiniti I30, I35, Q45 & QX4 and Nissan Maxima
& Pathfinder 2004 - 1996

UNIT PACKAGE: 25



22286

(Nissan: 80287-37F00)
Natural Nylon

**Front Door, Garnish &
Interior Trim Retaining Clip**

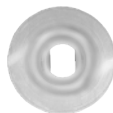

Head Diameter: 14mm
Stem Length: 10mm
Overall Height: 11.5mm
Infiniti FX35, FX45, G35, G37 &
Q60 and Nissan Murano 2015 - 2003

UNIT PACKAGE: 25



21689

(Nissan: 66820-61U00)
Black Nylon

Cowl Grille Retainer

Head Diameter: 11mm
Stem Diameter: 4.5mm
Stem Length: 15mm
Infiniti M45 & Q45 and Nissan Sentra 1997 - On

UNIT PACKAGE: 25



21519

(01553-01A50)
Black Nylon

Bumper & Trim Retainer

Head Diameter: 12mm
Stem Diameter: 6mm
Stem Length: 15mm
Infiniti FX35, G35, G37, M35, M45 & Q45 and
Nissan 350Z & 370Z 1997 - On

UNIT PACKAGE: 25



22075

(Nissan: 01553-06451)
Black Nylon

**Upper Quarter Trim &
Rear Trunk Seal Retainer**

Head Diameter: 20mm
Stem Diameter: 8.7mm
Stem Length: 16mm
Infiniti G35, J30, JX60, M35, M37, M56, Q45, Q50 & QX60
and Nissan Altima, Pathfinder & Quest 1996 - On

UNIT PACKAGE: 25



19468

(65846-40F00)
Black Nylon

Hood Insulation Retainer

Head Diameter: 28mm
Stem Diameter: 6mm
Stem Length: 10mm
J30, M30 & Q45 1989-On

UNIT PACKAGE: 15



22063

(Nissan: 01553-02903)
White Nylon

**Front Side Lower Fender
Panel Bracket Retainer**

Top Head Diameter: 13mm
Bottom Head Diameter: 12mm
Stem Length: 14mm
Overall Length: 21mm
Infiniti Qx4 & Qx56 and Nissan Pathfinder,
Frontier & Xterra 2010 - 1997

UNIT PACKAGE: 25



22897

(Nissan: 01553-09131)
Blue Nylon

Quarter Trim Panel Retainer

Top Head Diameter: 13mm
Middle Head Diameter: 16mm
Bottom Head Diameter: 18mm
Stem Diameter: 9mm
Stem Length: 10mm
Infiniti G35, I30, I35 & M45 2007 - 2000 Q50 &
Q60 2014 - On; Nissan 200SX & Sentra 1999 - 1995,
350Z, Altima & Quest 2008 - 1999 GT-R,
Maxima & Xterra 2005 - On

UNIT PACKAGE: 25



20668

(01553-09791)
White Nylon

Trim Panel Retainer

Top Head Diameter: 13mm
Middle Head Diameter: 16mm
Bottom Head Diameter: 18mm
Stem Diameter: 9mm
Stem Length: 14mm
Overall Length: 20mm
Nissan & Infiniti 1999 - On

UNIT PACKAGE: 15



21414
(80999-VE000)
White Nylon

Trim Panel Retainer with Sealer
Top Head Diameter: 13mm
Middle Head Diameter: 16mm
Bottom Head Diameter: 18mm
Stem Diameter: 9mm
Stem Length: 13mm
Overall Length: 19.5mm
Infiniti and Nissan 1993 - On

UNIT PACKAGE: 25



22832
(Nissan: 01553-10481)
White Nylon

Interior Liftgate Trim Retainer
Top Head Diameter: 13mm
Middle Head Diameter: 16mm
Bottom Head Diameter: 18mm
Stem Diameter: 9.5mm
Stem Length: 16mm
Overall Length: 22mm
Infiniti EX35, EX37, FX35, FX37, FX50, QX50 & QX70 and
Nissan Murano 2017 - 2009; Xterra 2011 - 2000

UNIT PACKAGE: 25



23989
(01553-10611)
Nylon

Door & Interior Trim Retainer
Top Head Diameter: 13mm
Bottom Head Diameter: 18mm
Stem Diameter: 9.4mm
Stem Length: 13mm
Overall Length: 20mm
Infiniti EX35, FX35/50, G37,
M37/56 2008 - On
Nissan 370Z & Juke 2009 - On

UNIT PACKAGE: 25



21633
(80850-89900)
White Nylon

Weather Retainer
Head Size: 6mm x 16mm
Stem Diameter: 6.5mm
Stem Length: 12mm
Infiniti I30, I35 & M45 and Nissan Maxima 2004 - 2000

UNIT PACKAGE: 25



22768
(Nissan: 84915-0W010)
White Nylon

Wheelhouse, Trunk Trim & Package Tray Retainer
Top Head Diameter: 14mm
Middle Head Diameter: 16mm
Bottom Head Diameter: 18mm
Stem Diameter: 9mm
Stem Length: 10mm
Overall Length: 16.5mm
Infiniti QX4 2003 - 1997
Nissan Pathfinder 2004 - 1996, Sentra 2013 - On

UNIT PACKAGE: 25



22769
(Nissan: 80850-89916)
Black Nylon

Door Weatherstrip Retainer
Head Size: 4mm x 10mm
Stem Diameter: 5.4mm
Stem Length: 10mm
Infiniti I30 2001 - 1996, I35 2004 - 2002
Nissan Juke 2015 - 2011, Maxima 2003 - 1995

UNIT PACKAGE: 50



22039
(Nissan: 01553-2DR9A)
Black Nylon

Push-Type Retainer
Top Head Diameter: 16mm x 19mm
Bottom Head Diameter: 20mm
Stem Length: 12mm
Fits into 8mm Hole
Infiniti G20, JX35, Q45 & QX60 and Nissan Frontier,
Maxima, NV, Pathfinder, Sentra,
Versa & Xterra 2002 - On

UNIT PACKAGE: 15



20669
(01553-07111)
Black Nylon

Trim Panel Retainer
Top Head Diameter: 13mm
Middle Head Diameter: 15mm
Bottom Head Diameter: 18mm
Stem Diameter: 9mm
Stem Length: 15mm
Overall Length: 20.5mm
Nissan Altima and
Infiniti G35 & Q45 1997 - On

UNIT PACKAGE: 25



21192
(Nissan: 01553-05323, 01553-05933,
01553-10721; Mazda: L33X13209)
Black Nylon

Cowl, Bumper, Fender Liner & Radiator Grille Push-Type Retainer
Head Diameter: 20mm
Stem Length: 12mm
Fits into 8mm Hole
Infiniti FX35, FX45, G35 and Nissan 2003 - On,
Frontier 2019 - 2005, Versa Note 2017, NV200 2013 - On;
Mazda 2, 3, 5, 6, CX-5, CX-7 & CX-9 2007 - On

UNIT PACKAGE: 10



22288
(01553-10641)
Green Nylon

Door & Interior Trim Panel Retainer
Top Head Diameter: 13mm
Middle Head Diameter: 16.4mm
Bottom Head Diameter: 18mm
Stem Diameter: 9.5mm
Stem Length: 15mm
Overall Length: 22mm
Infiniti FX35, FX 37, FX50 & QX70 2009 - On

UNIT PACKAGE: 25



20953
(11296-AG000)
Black Nylon

Front Bumper and Radiator Support Push-Type Retainer
Head Diameter: 20mm
Stem Length: 13mm
Fits into 8mm Hole
Infiniti FX 35/45 and Nissan Altima, Maxima & Quest 2002 - On

UNIT PACKAGE: 25



21545

(01553-08231)
Black Nylon

**Front & Rear Bumper
and Grille Push-Type Retainer**

Head Diameter: 20mm
Stem Length: 15mm
Fits into 8mm Hole
Infiniti FX35, FX45 & Q45 and Nissan
Murano, 240SX & 350Z 1995 - On

UNIT PACKAGE: 25



21646

(80874-AX000)
Black Nylon

Hole Plug

Head Diameter: 25mm
Fits into 18mm Hole
Infiniti EX35 and Nissan Juke & Murano 2003 - On

UNIT PACKAGE: 25

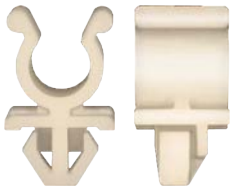

22358

(Nissan: 65722-01E00)
White Nylon

Hood Prop Rod Clip

Holds 8mm Diameter Rod
Overall Height: 23mm
Fits into 9mm Hole
Infiniti G20 & QX4 2003 - 1991
Nissan 200SX, 240SX, 300ZX, 370Z, Altima, Frontier,
Pathfinder, Sentra, Stanza & Xterra 1986 - On

UNIT PACKAGE: 15



21637

(01553-05131)
Black Nylon

**Wheel Liner, Cowl Insulator
& Trim Flange Clip**

Flange Diameter: 20mm
Hex: 10.5mm
Overall Height: 12.5mm
Infiniti EX35, FX35, FX50, G25, G35, G37, J30, M35, M45 &
Q45 and Nissan 370Z, Altima, Cube, Frontier, GT-R, Juke,
Leaf, Maxima, Murano, NV, Pathfinder, Quest, Rouge,
Versa & Xterra 1993 - On

UNIT PACKAGE: 15



25186

(Nissan: 63848-5L300)
Black Nylon

Cowl Trim Retainer Nut

Thread Size: M5-0.8
Flange O.D.: 20mm
Hex Size: 14mm
Height: 10mm
Nissan 350Z 2009 - 2003; 370Z, GT-R 2009 - On;
Armada 2017 - On; Leaf 2017 - 2011;
Maxima 2003 - 1997; NV200 2013 - On;
Infiniti EX35 2017 - 2008; EX37 2017 - 2013;
FX35 2012 - 2003; FX37 2013; FX45, G35 2008 - 2003;
FX50 2013 - 2009; G20 2002 - 1999; G25 2013 - 2011; G37
2015 2008; I30 2001 - 1998; I35 2004 - 2002;
M35 2001 - 2006; M37, M56, Q70 2019 - 2011;
M45 2010 - 2006; Q40 2015 - 2014; Q50,
Q60 2014 - On; QX50 2018 - On; QX 56,
QX80 2011 - On; QX70 2017 - 2014

UNIT PACKAGE: 10



21664

(63848-9Y000)
Black Nylon

Fender Apron Clip

Width: 20mm
Width at Wings: 30mm
Overall Length: 30mm
Infiniti EX35, FX35, FX50, G35, G37, M35, M37, M45 & M56
and Nissan Altima, Maxima, Murano,
Pathfinder, Quest & 370Z 2005 - On

UNIT PACKAGE: 10



21017

(76882-0M000)
White

Nylon U-Nut

Screw Size: M4.8 (#10)
Panel Range: Up to 1.5mm
Center of Hole to Edge: 8mm
Nissan & Infiniti 1995 - On

UNIT PACKAGE: 15



21459

(01241-00881)
Black Nylon

**Nylon U-Nut
with Captive Metal Hex Nut**

Thread: M6 - 1.0
Center of Hole to Edge: 14mm
Panel Range: Up to 4mm
Nissan Altima, Maxima & 240SX
and Infiniti I30 2001 - 1993

UNIT PACKAGE: 10

25092

(Infiniti & Nissan: 01241-01051)

**Black Nylon & Black Metal Nut License Plate Bracket
U-Nut with Encapsulated Hex Nut**



Screw Size: M6-1.0
Width: 16mm
Length: 28mm
Panel Range: 3.5mm
Center of Hole To Edge: 13.5mm
Infiniti G35 2007 - 2004, G37 2013 - 2009, M35,
M45 2009 - 2006, Q60 2015 - 2014, Q70 2019 - 2014,
QX50 2017 - On, QX80 2019 - 2017
Nissan 350Z 2009 - 2003; 370Z 2009 - On,
Armada 2017 - On, Cube 2014 - 2009,
Frontier 2019 - 2013, Leaf 2017 - 2011,
Pathfinder 1999 - 1996, Rouge 2013 - 2009,
Sentra 2018 - 2013, Versa 2019 - 2007

UNIT PACKAGE: 25



17195

(8942180270)
Black Nylon

Grille Clip

Width: 13mm
Length: 22mm

Ford Escort, Honda,
Isuzu, Mitsubishi & Plymouth Laser

UNIT PACKAGE: 25

17355

(GM: 94467458;
Isuzu: 8944674584)
Nylon



Windshield Reveal Moulding Clip

Isuzu and Geo Storm 1992 - On

UNIT PACKAGE: 10



14739

(Isuzu: 8941340270;
Toyota: 90189-05012)
Natural Nylon

Screw Size: #6
Width: 16mm
Length: 12mm

Snaps into 6mm x 10mm Hole

UNIT PACKAGE: 50



14269

(Isuzu: 8942264920;
Mazda: 9927-40-825;
Toyota: 67771-01010, 67771-12010)
White Nylon

Door Panel Retainer

Top Head Diameter: 13mm
Middle Head Diameter: 15.5mm
Bottom Head Diameter: 18mm
Stem Length: 14mm
Overall Length: 20.5mm
Stem Diameter: 9.5mm

UNIT PACKAGE: 25



14696

(Isuzu: 8942981190;
Honda: 90684-SA5-003;
Nissan: 10998-30880)
Black Nylon

Push-Type Retainer

Head Diameter: 15mm
Stem Length: 11mm
Fits into 6mm Hole

UNIT PACKAGE: 25



14727

(Isuzu: 8942211500; GM: 94221150;
Nissan: 63844-00100)
Black Nylon

Push-Type Retainer

Head Size: 14mm x 22mm
Stem Length: 9mm
Fits into 7mm Hole

UNIT PACKAGE: 25

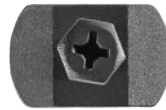

23807

(GM: 8-94133167-0)
Nylon

Cowl Screen Retainer

Head Diameter: 8mm
Stem Length: 13mm
GM Spectrum & Isuzu 1985 - On

UNIT PACKAGE: 100



17076

(GM: 94145515;
Isuzu: 89414-55150)

**Inner Fender Shield &
Bumper Fascia Retainer**

Head Diameter: 18mm
Stem Length: 23mm
Stem Diameter: 7mm
Geo Storm & Isuzu 1990-On

UNIT PACKAGE: 25

22247
(C2Z11575)
Black Nylon

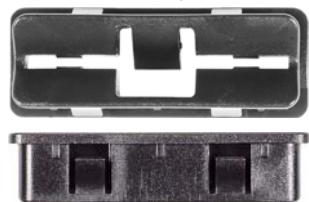

Headliner Retaining Clip
Width: 14.5mm
Length: 39.3mm
Overall Height: 9.5mm
Jaguar XF & XFR 2009 - On

UNIT PACKAGE: 15

22246
(C2Z11576)
Black Nylon



Headliner Retaining Clip
Width: 16mm
Length: 51mm
Overall Height: 10mm
Jaguar XF & XFR 2009 - On

UNIT PACKAGE: 15



22157
(C2D5807)
Yellow Nylon

Rocker Moulding Retainer
Top Head Diameter: 13mm
Middle Head Diameter: 16mm
Bottom Head Diameter: 18mm
Stem Diameter: 12mm
Stem Length: 11mm
Overall Length: 20mm
Jaguar XJ & XJ-L 2011 - On

UNIT PACKAGE: 15



22250
(C2C14628)
Black Nylon

Trim Panel Retainer with Sealer
Top Head Diameter: 15mm
Bottom Head Diameter: 18mm
Stem Diameter: 7.2mm
Stem Length: 20mm
Jaguar 2015 - On

UNIT PACKAGE: 15



22256
(XR831159)
Black Nylon

Radiator Support & Air Deflector Shield Push-Type Retainer
Head Diameter: 24mm
Stem Length: 12mm
Fits into 12mm Hole
Jaguar X, XF, XJ-L & XK 2012 - On

UNIT PACKAGE: 10

KIA CLIPS & FASTENERS



22007
(Hyundai: 84747-2L000)
White Nylon

Trim Panel & Dash Console Clip
Overall Length: 21mm
Hyundai Elantra, Entourage,
Sonata & Veloster 2006 - On
Kia Forte, Sorento & Soul 2010 - On

UNIT PACKAGE: 50



22317
(Hyundai: 85859-3S100)
Black Nylon

Interior Trim Clip
Overall Height: 19mm
Width at Bottom: 15mm
Hyundai Accent, Azera, Elantra & Sonata
and Kia Optima & Rio 2011 - On

UNIT PACKAGE: 50



22316
(Hyundai: 85858-3S000)
Black Nylon

Interior Trim Clip
Overall Height: 16mm
Width at Bottom: 11mm
Hyundai Accent, Azera 2017 - 2012,
Elantra 2017 - 2013, Sonata 2014 - 2011,
Kia Forte 2018 - 2014, Optima 2016 - 2011,
Rio 2017 - 2012, Soul 2011 - On,
Telluride 2020 - On

UNIT PACKAGE: 50



21863
(Hyundai: 87758-35010)
White Nylon

Moulding Clip with Sealer
Top Head Size: 10mm x 12mm
Bottom Head Size: 14mm x 18mm
Stem Length: 10mm
Hyundai Accent, Kia Soul &
Mitsubishi Outlander 2006 - On

UNIT PACKAGE: 15



21484
(87756-3E500)
Red Nylon

Wheel Flare & Body Side Moulding Clip with Sealer
Top Head Size: 11mm x 13mm
Bottom Head Size: 12mm x 20mm
Stem Length: 10mm
Forte Koup & Sorento 2009 - On

UNIT PACKAGE: 15



22329
(Hyundai: 87758-38000)
White Nylon

Rocker Moulding Clip with Sealer
Top Head Size: 10mm x 13mm
Bottom Head Size: 7mm x 16mm
Stem Length: 9mm
Hyundai Sonata 2001 - 1999
Kia Optima & Sorento 2009 - 2001

UNIT PACKAGE: 50



22326
(87756-C5000)
Red Nylon

Fender, Rocker & Wheel Moulding Clip with Sealer
Top Head Size: 10mm x 12mm
Bottom Head Size: 14mm x 20mm
Stem Length: 10mm
Kia Sorento 2016 - On

UNIT PACKAGE: 25



22366
(Kia: 87382-2W000)
Gray Nylon

Liftgate Moulding Clip with Sealer
Top Head Size: 10mm x 12mm
Bottom Head Size: 14mm x 20mm
Stem Length: 12mm
Overall Length: 16mm
Kia Cadenza, Optima & Sorento 2013 - On

UNIT PACKAGE: 25



22014
(87758-3E000, 87759-3E000, 87719-02500)
White Nylon

Fender Flare & Door Moulding Clip with Sealer
Top Head Size: 10.5mm x 9.5mm
Bottom Head Size: 14mm x 17.5mm
Stem Diameter: 14.3mm
Stem Length: 10mm
Kia Sorento 2009 - 03

UNIT PACKAGE: 25



22015
(Hyundai: 87756-1F000, Kia: 87756-3R000)
Blue Nylon

Fender Flare, Rocker, Door & Exterior Moulding Clip with Sealer
Top Head Size: 10mm x 12mm
Bottom Head Size: 14mm x 20mm
Stem Diameter: 14mm
Stem Length: 10mm
G70 2022 - 2019, G90 2019 - 2017, GV70 2022, GV80 2022 - 2021, Elantra 2020 - 2017, Kona 2022 - 2018, Palisade 2022 - 2020, Santa Fe 2022 - 2013, Tucson 2021 - 2016, Veloster 2022 - 2019, Venue 2022 - 2020, Cadenza 2016 - 2014, Forte 2021 - 2020, Niro 2021 - 2017, Seltos 2022 - 2021, Soul 2019 - 2014, Sportage 2022 - 2005, Telluride 2022 - 2020, Sorento 2022 - 2021

UNIT PACKAGE: 25



22470
(Hyundai: 87716-2W000)
White Nylon

Fender, Body Side & Rocker Moulding Clip with Sealer
Top Head Size: 10mm x 12mm
Bottom Head Size: 14mm x 20mm
Stem Length: 11mm
Hyundai Santa Fe 2012 - On
Kia Borrego 2011 - 2007 & Kia Niro 2017 - On

UNIT PACKAGE: 50



21457
(86359-33500)
White Nylon

Front Bumper Moulding Clip
Top Head Size: 10mm x 15mm
Bottom Head Size: 16mm x 18mm
Stem Length: 9mm
Spectra 2009 - 04

UNIT PACKAGE: 25

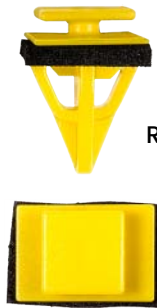

22331
(Hyundai: 87759-3V000)
Yellow Nylon

Rocker Panel Moulding Clip with Sealer
Top Head Size: 12mm x 12mm
Bottom Head Size: 14mm x 20mm
Stem Length: 17mm
Hyundai Azera 2012 - On
Kia K900 2015 - On

UNIT PACKAGE: 25



21363
(86591-25000)
Black Nylon

Bumper Cover Clip with Sealer
Head Size: 25mm x 30mm
Stem Length: 15mm
Overall Length: 35mm
Rio 2010 - On

UNIT PACKAGE: 5



21069
(92351-37000)
Natural Nylon

Headlight Assembly Grommet
Head Diameter: 15mm
Stem Length: 8mm
Fits into 10mm Hole
Hyundai 2001 - On
Kia Rio & Spectra 2000 - On

UNIT PACKAGE: 25



25333
(Kia: 86899-2T500)
Black Nylon

Fender Liner Screw Grommet
Screw Size: M3.5 (#6)
Head Size: 11.5mm
Stem Length: 13mm
Overall Height: 15mm
Fits into 7mm sq. Hole
Kia Optima 2020-2017

UNIT PACKAGE: 50



22322
(Hyundai: 86518-3M000)
White Nylon

Bumper Grommet
Screw Size: M3.5 (#6)
Head Size: 8mm x 10mm
Stem Length: 12mm
Hyundai Azera & Sonata 2012 - On
Kia Cadenza 2014 - On

UNIT PACKAGE: 25



22564
(Hyundai: 14910-04000, 92561-25000)
Natural Nylon

License Plate Grommet
Screw Size: M3.5 (#6)
Head Diameter: 12mm
Stem Length: 7mm
Overall Height: 9mm
Hyundai Accent, Azera, Elantra, Entourage, Excel, Ionia, Santa Fe, Scoupe, Tiburon, Tucson, Veloster, XG300 & XG350 1985 - On
Kia Optima & Rio 2016 - 2010

UNIT PACKAGE: 25



22323
(86625-1M000)
White Nylon

Bumper Grommet
Screw Size: M4.8 (#10)
Head Size: 8mm x 10mm
Stem Length: 12mm
Kia Optima 2011 - On
UNIT PACKAGE: 25



21371
(86699-2D000)
White Nylon

Front & Rear Bumper Cover Nylon Nut
Head Size: 11mm x 11mm
Stem Length: 9mm
Overall Length: 13.5mm
Forte Koup 2010 - On
UNIT PACKAGE: 25



22017
(Hyundai: 87756-34520)
Green Nylon

Fender & Door Moulding Nylon Nut
Screw Size: M3.5 (#6)
Head Size: 13mm x 13mm
Stem Diameter: 13.5mm
Stem Length: 8mm
Hyundai Tucson 2009 -2005; Kia Optima 2006 - 2001
UNIT PACKAGE: 50



21066
(87758-37000)
White Nylon

Fender & Rocker Moulding Nylon Nut with Sealer
Screw Size: M4.2 (#8)
Head Size: 17mm x 17mm
Stem Length: 14mm
Hyundai 1999 - On
Kia Optima & Sorento 2001 - On
UNIT PACKAGE: 25



22562
(Hyundai: 86625-1E000)
White Nylon

Bumper Bracket Screw Grommet with Sealer
Screw Size: M4.8 (#10)
Top Head Size: 14mm x 18mm
Bottom Head Diameter: 18mm
Stem Size: 8.5mm x 8.5mm
Stem Length: 18mm
Hyundai Elantra GT 2013 - On
Kia Niro & Sorento 2016 - On
UNIT PACKAGE: 25



20567
(87756-38000)
Black Nylon

Body Side Moulding Clip with Sealer
Top Head Size: 8mm x 9mm
Bottom Head Size: 14mm x 18mm
Stem Length: 10mm
Elantra & Sonata 2002 - On Kia Rio 2010 - On
UNIT PACKAGE: 15



22438

(Hyundai: 87715-3K000)
White Nylon

**Door Trim, Roof & Spoiler
Moulding Clip with Sealer**

Head Size: 9mm x 18.3mm

Stem Length: 10mm

Hyundai Azera, Equus, Genesis, Sonata,
Tucson & Veloster and Kia Soul 2006 - On

UNIT PACKAGE: 25



22321

(Hyundai: 86438-2T000)
Black Nylon

Hood & Bumper Seal Retainer

Head Size: 4.5mm x 13mm

Stem Diameter: 7.6mm

Stem Length: 7.5mm

Hyundai Elantra & Genesis 2013 - On
Kia K900 & Optima 2011 - On

UNIT PACKAGE: 50



21381

(86438-4A100)
Black Nylon

Hood Seal Retainer

Head Size: 5mm x 13mm

Stem Diameter: 8mm

Stem Length: 11mm

Hyundai Elantra & Tucson
and Kia Forte & Sportage 2009 - On

UNIT PACKAGE: 50



21382

(86434-4A000)
Black Nylon

Hood Sealer Retainer

Head Size: 6mm x 16mm

Stem Diameter: 8mm

Stem Length: 14mm

Hyundai Elantra, Sonata & Tucson
and Kia Sportage 2009 - On

UNIT PACKAGE: 50



22325

(Hyundai: 87756-2W000)
Red Nylon

Weatherstrip Retainer

Head Size: 5mm x 15mm

Stem Diameter: 7mm

Stem Length: 8mm

Hyundai Santa Fe & Kia Sorento 2013 - On

UNIT PACKAGE: 100



21349

(85746-06000LX)
Gray Nylon

Headliner Retainer

Head Diameter: 18mm

Stem Diameter: 8mm

Stem Length: 16mm

Rio 2010 - On

UNIT PACKAGE: 25



21350

(85746-06000RU)
Tan Nylon

Headliner Retainer

Head Diameter: 18mm

Stem Diameter: 8mm

Stem Length: 16mm

Rio 2010 - On

UNIT PACKAGE: 25



20543

(81126-37010)
Black Nylon

Hood Insulation Retainer

Head Diameter: 26mm

Stem Diameter: 12mm

Stem Length: 14mm

Hyundai Elantra & Sonata and Kia Optima 1995 - On

UNIT PACKAGE: 15



22319

(Hyundai: 86179-2V020)
Blue Nylon

Garnish Moulding Retainer with Sealer

Top Head Size: 10.5mm x 12mm

Bottom Head Diameter: 12mm

Stem Length: 11mm

Fits into 7.5mm Hole

Hyundai Veloster 2012 - On; Kia Soul 2014 - On

UNIT PACKAGE: 25



22370

(Hyundai: 92485-2H000)
White Nylon

**Rear Lamp Moulding
Retainer with Sealer**

Top Head Diameter: 17mm

Bottom Head Diameter: 15mm

Stem Length: 11mm

Fits into 6mm Hole

Hyundai Accent, Elantra, Equus,
Genesis, Genesis Coupe, Santa Fe,
Sonata, Veloster & Veracruz
and Kia Forte, Optima, Rio
& Sportage 2007 - On

UNIT PACKAGE: 15



22592

(Hyundai: 85818-37000)
White Nylon

Moulding Clip With Sealer

Top Head Size: 12.5mm x 14mm
Bottom Head Diameter: 16mm
Stem Diameter: 10mm
Stem Length: 12.5mm

Hyundai Accent, Elantra & Tucson and
Kia Optima & Rio 2012 - On

UNIT PACKAGE: 25



22003

(Hyundai: 82315-2P000)
White Nylon

Trim Panel Retainer

Top Head Diameter: 13mm
Middle Head Diameter: 15mm
Bottom Head Diameter: 18mm
Stem Diameter: 11mm
Stem Length: 13mm

Overall Length: 19mm
Hyundai & Kia 1999 - On

UNIT PACKAGE: 50



22009

(Hyundai: 85506-4A000)
White Nylon

Trim Panel & Window Garnish Retainer

Top Head Diameter: 13mm
Middle Head Diameter: 16mm
Bottom Head Diameter: 15mm
Stem Diameter: 9.6mm
Stem Length: 13mm
Overall Length: 20mm

Hyundai Tucson & Kia Sorento 2003 - On

UNIT PACKAGE: 50



22312

(0K95-A-68401)
Gray Nylon

Exterior & Interior Moulding Retainer

Top Head Diameter: 13mm
Middle Head Diameter: 16mm
Bottom Head Diameter: 15mm
Stem Diameter: 9.5mm
Stem Length: 12mm
Overall Length: 18mm

Kia Soul, Sedona & Sportage 2010 - On

UNIT PACKAGE: 50



21070

(Hyundai: 82315-38000)
GM: 94530565)
White Nylon

Trim Panel Retainer

Top Head Diameter: 13mm
Middle Head Diameter: 16mm
Bottom Head Diameter: 16mm
Stem Diameter: 9.5mm
Stem Length: 10mm
Overall Length: 10mm

Chevrolet 2004 - On Hyundai 1999 - On
Kia Optima, Rio & Sorento 2001 - On

UNIT PACKAGE: 25



22008

(Hyundai: 85495-2E050)
Black Nylon

Headliner Retainer

Top Head Diameter: 14mm
Middle Head Diameter: 15mm
Bottom Head Diameter: 16mm
Stem Diameter: 10.3mm
Stem Length: 10mm
Overall Length: 15.5mm

Hyundai & Kia

UNIT PACKAGE: 50



21188

(82315-27000)
Pink Nylon

Trim Panel Retainer

Top Head Diameter: 15mm
Middle Head Diameter: 16mm
Bottom Head Diameter: 18mm
Stem Diameter: 10mm
Stem Length: 12mm

Hyundai & Kia 2003 - On

UNIT PACKAGE: 15



22313

(Hyundai: 82315-2W000)
Green Nylon

Door Panel, Interior Trim & Garnish Retainer

Top Head Diameter: 13mm
Middle Head Diameter: 16mm
Bottom Head Diameter: 18mm
Stem Diameter: 10mm
Stem Length: 10mm
Overall Length: 17mm

Hyundai Santa Fe & Sonata 2013 - On
Kia Forte & K900 2014 - On

UNIT PACKAGE: 25



22315
 (Hyundai: 85849-3L000)
 Gray Nylon

Garnish & Interior Moulding Retainer
 Top Head Diameter: 13mm
 Middle Head Diameter: 16.5mm
 Bottom Head Diameter: 18mm
 Stem Length: 15mm
 Overall Length: 21mm
 Fits into 9mm Hole
 Hyundai Azera, Sonata &
 Tuscon 2006 - On
 Kia Forte 2010 - On

UNIT PACKAGE: 50



22005
 (Hyundai: 82315-33020)
 White Nylon

Trim Panel Retainer
 Top Head Diameter: 15mm
 Middle Head Diameter: 16mm
 Bottom Head Diameter: 18mm
 Stem Diameter: 10.7mm
 Stem Length: 12mm
 Overall Length: 18.5mm
 Hyundai & Kia 1995 - On

UNIT PACKAGE: 50



21530
 (Subaru: 909130067;
 Hyundai: 86590-3S000)
 Black Nylon

Engine Cover and Fender Liner Push-Type Retainer
 Head Diameter: 18mm
 Stem Length: 10mm
 Fits into 8mm Hole
 B9 Tribeca, Forester, Legacy &
 Outback & Tribeca. 2005 - On
 Hyundai Azera, Elantra, Genesis & Sonata
 and Kia Cadenza & Optima 2011 - On

UNIT PACKAGE: 15



22595
 (Hyundai: 86590-1W000)
 Black Nylon

Bumper Cover Push-Type Retainer
 Head Diameter: 18mm
 Stem Length: 11mm
 Fits Into 8mm Hole
 Hyundai Equus & Genesis 2016 - 2014
 Kia Rio & Sedona 2012 - On

UNIT PACKAGE: 25



21146
 (0G032-50037-A)
 Black Nylon

Bumper, Render, Grille, Interior & Exterior Trim and Pillar Push-Type Retainer
 Head Diameter: 18mm
 Stem Length: 12mm
 Fits into 8mm Hole
 Amanti, Magentis, Optima,
 Rio, Sedona, Sephia, Sorento,
 Spectra & Sportage 2000 - On

UNIT PACKAGE: 15



22253
 (Hyundai: 86595-2T500, 14206-08250-B)
 Black Nylon

Bumper, Engine Under Cover & Fender Liner Push-Type Retainer
 Head Diameter: 18mm
 Stem Length: 14mm
 Fits into 8mm Hole
 Hyundai Elantra, Equus, Genesis, Santa Fe
 & Sonata and Kia Forte, K900, Optima,
 Sedona & Sorento 2013 - On

UNIT PACKAGE: 15



22435
 (Hyundai: 84219-3L000)
 Black Nylon

Engine Under Cover & Rear Bumper Moulding Grommet
 Screw Size: M6-1.0
 Head Diameter: 20mm
 Stem Diameter: 14mm
 Stem Length: 7mm
 Overall Length: 9.5mm
 Hyundai Azera, Equus, Genesis, Santa Fe & Sonata and
 Kia Forte, Optima & Rio 2010 - On

UNIT PACKAGE: 25



22299
 (Hyundai: 86590-35000)
 Black Nylon

Bumper Cover Push-Type Retainer
 Head Diameter: 20mm
 Stem Length: 26mm
 Fits into 9.5mm Hole
 Hyundai Tucson 2009 - 2005

UNIT PACKAGE: 25



16858
 (Kia: MNA01-56-145;
 Mazda: NA01-56-145;
 Nissan: 63844-01A00;
 Ford: MNA01-56145, NA01-56145)
 Black Nylon

Inner Fender Push-Type Retainer
 Head Diameter: 20mm (25/32")
 Stem Length: 18mm (23/32")
 Fits into 8mm (5/16") Hole
 Kia, Ford, Mazda & Nissan

UNIT PACKAGE: 25



22505

(Hyundai: 86825-26000)
Black Nylon

Rear Fender Liner Plug
Head Diameter: 30mm
Overall Height: 16.5mm
Hyundai Accent, Equus,
Genesis, Santa Fe,
Tucson & Veracruz 2011 - On
Kia Sorento 2016 - 2011

UNIT PACKAGE: 15



21372

(OK95A-68615)
Black Nylon

Cowl Trim Retainer
Flange Diameter: 25mm
Hex Size: 14mm
Overall Height: 10mm
Forte Koup 2010 - On

UNIT PACKAGE: 25



21745

(GM: 11609651)
Zinc

**Windshield Garnish and
Interior Trim Moulding Fastener**
Screw Size: M4.2 (#8)
Stem Width: 13mm
Head Size: 13.5mm x 20.5mm
Overall Length: 22mm

Buick Enclave & Encore; Cadillac CTS, Escalade, STS & XTS; Chevrolet Avalanche, Camaro, Cobalt, Corvette, HHR, Impala, Malibu, Monte Carlo, Silverado, Suburban, Tahoe & Traverse; Dodge Truck; Ford Flex & Taurus; GMC Sierra & Yukon; Kia Sorento & Soul; Pontiac G6 & G8; Saturn Outlook and Suzuki Grand Vitara 2004 - On

UNIT PACKAGE: 15



21378

(86825-28000)
Black Nylon

Nylon U-Nut
Screw Size: M6 (#14)
Panel Range: Up to 1.5mm
Center of Hole to Edge: 8mm
Hyundai Accent & Elantra
and Kia 1995 - On

UNIT PACKAGE: 25

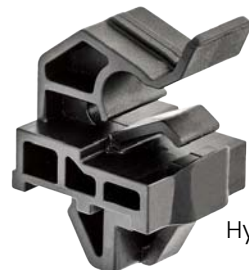

22506

(Hyundai: 81174-2L000)
Black Nylon

Hood Prop Rod Clip
Width: 20mm
Length: 24mm
Holds 8mm Rod
Hyundai Accent & Elantra 2008 - On
Kia Forte & Soul 2013 - 2009

UNIT PACKAGE: 15



25410

(Hyundai: 13510-04123)
Black Zinc

Headlamp Mounting Washer
Screw Size: 4mm
Inner Diameter: 4.3mm
Outer Diameter: 12mm
Thickness: 1.0mm
Hyundai Sonata 1993 - 1988 & General
Purpose

UNIT PACKAGE: 50



25198

(Hyundai & Kia: 81199-38000)
Black Nylon

Hood Release Cable Clip
Holds 7mm Dia. Tube/Cable
Fits into 8mm Hole
Overall Height: 19.7mm
Hyundai Accent, Veloster 2011 - On;
Elantra 2015 - On; Genesis 2019 - On;
Ioniq 2017 - On; Kona 2018 - On;
Nexo 2019 - On; Venue 2020 - On;
Kia Seltos & Soul 2019 - 2010;
Sportage 2011 - On

UNIT PACKAGE: 25



25199

(Hyundai & Kia: 81199-33000)
Black Nylon

Hood Release Cable Clip
Holds 7mm Dia. Tube/Cable
Fits into 8mm Hole
Overall Height: 19mm
Hyundai Accent 2005 - 1995; Azera 2017 - 2006;
Elantra 1992 - On; Entourage 2008 - 2007;
Equus 2016 - 2011; Genesis 2016 - On; Palisade 2020 - On;
Santa Fe 2012 - 2001; Scoupe 2001 - 1991;
Sonata 1995 - On; Tiburon 2008 - 1997;
Tucson 2005 - On; Veracruz 2012 - 2007; XG300 2001;
XG350 2005 - 2002; Kia Borrego 2009;
Cadenza 2014 - On; Forte 2018 - 2014; K5 2021 - On;
K900 2015 - On; Niro 2017 - On; Optima 2001 - On;
Roi 2018 - 2012; Sedona 2014 - 2006; Sorento 2011 - On;
Sportage 2005 - On; Stinger 2018 - On;
Telluride 2020 - On

UNIT PACKAGE: 25



22507

(Hyundai: 81174-21000,
81174-11011 & 81174-21010)
Black Nylon

Hood Prop Rod Clip
Holds 8mm Rod
Bottom Base Size: 20mm x 20mm
Stem Length: 9mm
Overall Length: 25mm
Hyundai Elantra, Sonata,
Tucson & Veloster 1997 - On

UNIT PACKAGE: 15



25424
(Land Rover: LR018173)
Black Nylon

Radiator Grille Clip
Head Size: 19mm x 33mm
Stem Length: 13mm
Fits into 10mm x 26mm Slot
Land Rover Defender 90, 110 2020,
Discovery 2021 – 2015,
LR4 2016 – 2010,
Range Rover 2021 – 2010

UNIT PACKAGE: 25



22145
(DYC000122)
White Nylon

Exterior Rear Door Lower Moulding Clip with Sealer
Width: 23mm
Length: 39.3mm
Stem Length: 19mm
Range Rover 2012 – 2003

UNIT PACKAGE: 10



21657
(DYC101420)
White & Yellow Nylon

Moulding Clip
Top Head Diameter: 12.5mm
Middle Head Diameter: 15mm
Bottom Head Diameter: 15mm
Stem Diameter: 10.2mm
Stem Length: 8mm

Land Rover, Freelander & Range Rover 2002 – On

UNIT PACKAGE: 25



22151
(DYC000091)
White Nylon

Lower Side Vent Grille Trim Moulding Clip with Sealer
Width: 37mm
Length: 40mm
Stem Length: 13mm
Range Rover 2012 – 2003

UNIT PACKAGE: 15



22154
(Ford: W717736-S300)
White Nylon

Wheel Opening Moulding Clip
Top Head Size: 14mm x 20mm
Bottom Head Size: 14mm x 18mm
Stem Length: 18mm
Fits into 9mm Hole
Ford F-150 2015 – On

UNIT PACKAGE: 10



22249
(DYH500131)
White Nylon

Upper Bumper Screw Grommet
Screw Size: M4.8 (#10)
Top Head Size: 9mm x 13mm
Stem Length: 13mm
Land Rover LR3, LR4 & Range Rover Sport 2005 – On

UNIT PACKAGE: 15



21657
(DYC101420)
White & Yellow Nylon

Moulding Clip
Top Head Diameter: 12.5mm
Middle Head Diameter: 15mm
Bottom Head Diameter: 15mm
Stem Diameter: 10.2mm
Stem Length: 8mm
Land Rover, Freelander & Range Rover 2002 – On

UNIT PACKAGE: 25



22085
(MWC3136)
White Nylon

Door Panel Grommet
Head Diameter: 14mm
Stem Length: 11mm
Overall Height: 14mm
Fits into 8mm Hole
Discovery, Freelander & Range Rover 2005 – 1995

UNIT PACKAGE: 25



22154
(Ford: W717736-S300)
White Nylon

Wheel Opening Moulding Clip
Top Head Size: 14mm x 20mm
Bottom Head Size: 14mm x 18mm
Stem Length: 18mm
Fits into 9mm Hole
Ford F-150 2015 – On

UNIT PACKAGE: 10



22485
(Land Rover: DCE100560)
Black Nylon

Tailgate Moulding Retainer
Base Size: 17.3mm x 16.3mm
Stem Diameter: 11mm
Stem Length: 15mm
Overall Height: 18.5mm
Land Rover Freelander 2006 – 1996

UNIT PACKAGE: 15



22148
(LR000080)
Black Nylon

Rear Tail Light Guide Grommet
Head Size: 18mm x 22mm
Stem Length: 15mm
Overall Height: 18mm
Range Rover 2014 - On

UNIT PACKAGE: 25



22150
(LR002229)
Black Nylon

Pillar Post Moulding Grommet
Head Diameter: 15.5mm
Stem Length: 15mm
Overall Height: 16.5mm
Land Rover Evoque 2012 - 2004

UNIT PACKAGE: 25



25426
(Land Rover: RYH500840)
White Nylon

Wheelhouse Liner Screw Grommet with Sealer

Screw Size: M4.2 (#8)
Head Diameter: 16mm
Stem Length: 20mm
Overall Height: 22mm
Fits into 9mm Hole
Land Rover Defender 2020,
Discovery 2021 - 2017, Range Rover 2012 - On

UNIT PACKAGE: 25



22245
(LR012844)
Black Nylon

Body Liner Twist to Lock Retainer
Slotted Head Diameter: 19mm
Stem Length: 23mm
Land Rover Discovery, Range Rover &
Range Rover Sport 2004 - On

UNIT PACKAGE: 15



25149
(Land Rover: DYR500010)
Black Nylon

Tow Bracket Cover Clip
Head Diameter: 19mm
Stem Length: 20mm
Slot Drive
Land Rover LR2 2015 - 2013; LR3
2009 - 2005; LR4 2016 - 2010;
Range Rover 2009 - 2006

UNIT PACKAGE: 25



22093
(DKP5279L)
Black Nylon

Trim Panel Retainer
Top Head Diameter: 12.3mm
Bottom Head Diameter: 12.3mm
Stem Diameter: 5.5mm
Stem Length: 17mm
Land Rover Discovery &
Defender 2004 - 1989

UNIT PACKAGE: 25



25334
(Land Rover: DYC500010)
Black Nylon

Wheel Flare Retainer
Top Head Diameter: 13mm
Bottom Head Diameter: 16mm
Stem Size: 8mm x 13mm
Stem Length: 12.5mm
Overall Height: 22mm
Land Rover LR3 2009-2005, LR4 2016-2010

UNIT PACKAGE: 25



21853
(VW: 7M0-867-299-K, 7M3-867-299;
Land Rover: DYC500020;
Ford: 1008068)
Yellow Nylon

Door Trim Panel Retainer with Sealer
Top Head Diameter: 13mm
Bottom Head Diameter: 17.5mm
Stem Diameter: 10.5mm
Stem Length: 15mm
Land Rover 1997 - On
VW & Audi 1999 - On

UNIT PACKAGE: 25



22153
(LR032984)
White Nylon

Front Door Louver Exterior Trim Retainer with Sealer
Top Head Size: 8mm x 10mm
Bottom Head Diameter: 15mm
Stem Diameter: 12mm
Stem Length: 8mm
Land Rover Evoque,
HSE & Range Rover 2014 - 2012

UNIT PACKAGE: 15



22244

(LR034389; LR053837)
White Nylon

Pillar Retainer with Sealer
Top Head Diameter: 14mm
(with extension: 21mm)
Bottom Head Diameter: 17mm
Stem Diameter: 10.8mm
Stem Length: 11mm
Land Rover Discovery &
Range Rover Sport 2010 - On

UNIT PACKAGE: 15



22251

(Landrover: LR013135; Ford: W714231-S300)
White Nylon

Trim Panel, Tail Gate & Luggage Compartment, Door, Pillar, Side Moulding, Sill Plate Retainer with Sealer
Top Head Diameter: 14.5mm
Bottom Head Diameter: 15mm
Stem Diameter: 11mm
Stem Length: 15mm
Land Rover LR3, Range Rover Sport & Range Rover Sport Supercharge 2009 - 2005;
Ford Transit Connect 2014 - On; 150, 250, 350 2015 - On

UNIT PACKAGE: 15



22152

(LR028939)
White Nylon

Front Lower Fender & Exterior Trim Retainer
Top Head Diameter: 12.5mm
Middle Head Diameter: 16mm
Bottom Head Diameter: 18mm
Stem Diameter: 11.5mm
Stem Length: 10mm
Overall Length: 16.5mm
Land Rover Evoque, HSE & Range Rover 2014 - 2012

UNIT PACKAGE: 25



22156

(IPN500050)
White Nylon

Windshield Glass Side Moulding Retainer with Sealer
Top Head Diameter: 13mm
Middle Head Diameter: 15mm
Bottom Head Diameter: 17mm
Stem Length: 13mm
Overall Length: 19mm
Land Rover HSE &
Range Rover Sport 2012 - 2006

UNIT PACKAGE: 15



22149

(LR027255)
Blue Nylon

Wheel Arch Moulding Retainer
Top Head Diameter: 14mm
Middle Head Diameter: 15.5mm
Bottom Head Diameter: 18mm
Stem Diameter: 10mm
Stem Length: 16mm
Overall Length: 23mm
Land Rover Evoque 2012 - 2004

UNIT PACKAGE: 15



22155

(LR033144)
Black Nylon

Pillar, Rocker & Floor Moulding Push-Type Retainer
Head Diameter: 13mm
Stem Length: 13mm
Fits into 8mm Hole
Land Rover HSE &
Range Rover 2012 - On

UNIT PACKAGE: 15



22248

(DYQ500060)
Black Nylon

Exterior Pillar Moulding Push-Type Retainer
Top Head Diameter: 19mm
Bottom Head Diameter: 13mm
Stem Length: 12mm
Fits into 8mm Hole
Range Rover Sport 2012 - 2006

UNIT PACKAGE: 25



25270

(Land Rover: DYF500010)
Black Nylon

Front Bumper & Tow Bracket Cover Clip
Width: 14mm
Length: 19mm
Fits into 12.7mm Slot
Use with Auveco No. 25149
Land Rover LR2 2015 - 2013, LR3, Range Rover 2009 - 2006, LR4 2020 - 2016

UNIT PACKAGE: 25



25425

(Land Rover: LR045194)
Yellow Nylon

Front & Rear Bumper and Fog Lamp U-Nut
Screw Size: M3.5 (#6)
Panel Range: 2.5mm
Center of Hole To Edge: 7mm
Width: 10mm
Length: 13.5mm
Land Rover Discovery 2020 - On,
Range Rover 2014 - On
UNIT PACKAGE: 25



21546
(90467-09204)
White Nylon

**Rear Hatch Door Side Garnish
and Front Body Pillar Garnish Moulding Clip**

Overall Height: 14mm
Lexus GS 300, GS 400, GS 430, GX 470, RX 330,
RX 350, RX 400 & RX 450 and Toyota Camry,
Highlander, Prius & Sienna 1998 - On

UNIT PACKAGE: 25



22351
(Toyota: 90467-10181)
Black Nylon

Headliner & Interior Trim Moulding Clip

Top Head Size: 18mm x 19mm
Bottom Head Size: 18mm x 24mm
Stem Diameter: 10mm
Stem Length: 13mm
Lexus ES 300h/350, GS 300/350/430/460,
IS 200T/250/300/350, NX 200T/300h, RC 200T/300/350
& RX 350/400h/450h and Toyota Avalon &
Camry 1998 - On

UNIT PACKAGE: 25



21549
(90467-12080)
Pink Nylon

**Door Trim, Instrument Panel,
Rear Deck Trim & Roof Garnish
Trim Moulding Clip**

Overall Height: 21mm
Lexus ES 350, GX 460, RX 330 & RX 450h and Toyota
Avalon, Camry, Corolla, Echo, FJ Cruiser, Highlander,
Matrix, Prius, RAV4, Sequoia, Sienna, Tacoma, Tundra,
Venza, Yaris & 4-Runner 2000 - On

UNIT PACKAGE: 25



22346
(Toyota: 53857-12010)
Black Nylon



Front Fender Moulding Clip with Sealer

Head Size: 20mm x 30mm
Stem Diameter: 9mm
Stem Length: 10mm
Lexus NX 200t, NX 300h, Scion iM and
Toyota Corolla & Prius 2015 - On

UNIT PACKAGE: 15



20661
(75397-33010)
White Nylon

Body Side Moulding Clip with Sealer

Head Size: 16mm x 20mm
Stem Length: 9mm
Lexus ES300 1997 - On

UNIT PACKAGE: 10



22127
(81496-50010)
Green Nylon

Rear Lamp Moulding Clip with Sealer

Top Head Diameter: 13mm
Bottom Head Diameter: 20mm
Stem Length: 10mm
Lexus GS 350, GS 450h, LS 460, LS 460 L, LS
600h L, RX 350 & RX 450h 2007 - On

UNIT PACKAGE: 15



22398
(Toyota: 81496-60010)
White Nylon

**Rear Combination Lamp Guide
Moulding Clip with Sealer**

Top Head Diameter: 13mm
Bottom Head Diameter: 20mm
Stem Length: 10.5mm
Lexus CT 200h, ES 300h, ES 350,
GX 470, IS F, IS 250, NX 200t, NX 300h,
RC F, RC 350, RX 330, RX 350, RX 400h
& RX 450h and Toyota 4Runner, Avalon, Camry,
Camry Hybrid, Corolla, Matrix, Prius, Prius C, RAV4,
Sienna, Venza & Yaris 2006 - On
Scion iQ & iQ EV 2014 - 2011

UNIT PACKAGE: 25



19900
(75395-33030)
Pink Nylon

Moulding Clip

ES300 & RX300 1999 - On



UNIT PACKAGE: 15



20877
(75392-60030,
75392-60031)
Gray Nylon

Rocker Panel Moulding Clip
Head Diameter: 18mm
Overall Length: 19mm
Lexus 2000 - On

UNIT PACKAGE: 15



21847
(Toyota: 90467-08195)
White Nylon

Front & Rear Fender Flare Moulding Clip with Sealer
Head Size: 15mm x 22mm
Stem Length: 13mm
Overall Length: 21mm
Lexus GX470 2009 - 03
Toyota Land Cruiser 2007 - 1998

UNIT PACKAGE: 25



21846
(Toyota: 90467-08196)
Yellow Nylon

Front & Rear Fender Flare and Mudguard Moulding Clip with Sealer
Head Size: 16mm x 22mm
Stem Length: 19mm
Overall Length: 27mm
Lexus GX470 2009 - 03
Toyota Land Cruiser 2007 - 1998

UNIT PACKAGE: 25



20875
(75394-60060)
Yellow Nylon

Fender Moulding Clip with Sealer
Head Diameter: 18mm
Stem Length: 20mm
Lexus 2000 - On

UNIT PACKAGE: 10



22456
(Toyota: 62955-50010)
Yellow Nylon

Rocker & Quarter Vent Moulding Clip with Sealer
Top Head Size: 8mm x 8mm
Bottom Head Diameter: 15mm
Stem Diameter: 8mm x 8mm
Stem Length: 11mm
Lexus ES 250, HS 250h, LS 460, LS 600h L,
RX 350 & RX 450h and Toyota Highlander,
RAV4 & Yaris 2013 - On

UNIT PACKAGE: 25



22396
(Lexus: 90467-08224)
White Nylon

Body Side & Wheel Opening Moulding Clip
Top Head Size: 10mm x 10.5mm
Bottom Head Diameter: 15mm
Stem Diameter: 8mm x 8mm
Stem Length: 8mm
Lexus NX 200t, NX 300h, RX 350
& RX 450h 2015 - On

UNIT PACKAGE: 25



21748
(Toyota: 75819-33010)
White Nylon

Moulding Clip with Sealer
Top Head Size: 8mm x 8mm
Bottom Head Diameter: 15mm
Stem Diameter: 10mm
Stem Length: 14mm
Lexus ES300 & ES330 & Scion
and Toyota Camry, Corolla, Prius, Sequoia,
Sienna & Tundra 2002 - On

UNIT PACKAGE: 25



21537
(90467-10190)
Black Nylon

Grille Clip
Top Head Size: 10mm x 10mm
Bottom Head Diameter: 15mm
Stem Diameter: 10mm
Stem Length: 10mm
RX 330, RX 350 & RX 400 1999 - On

UNIT PACKAGE: 25



22479
(Lexus: 51787-60070)
White Nylon

Door Scuff Plate Retainer
Top Head Size: 12mm x 17mm
Middle Head Diameter: 15mm
Bottom Head Diameter: 18mm
Stem Diameter: 8.5mm
Stem Length: 9mm
Lexus GX 460 & LX 570 2003 - On

UNIT PACKAGE: 25



22454
(Toyota: 76817-68010)
Yellow Nylon

Door Garnish Clip with Sealer
Top Head Size: 10mm x 10mm
Bottom Head Diameter: 16mm
Stem Diameter: 9.5mm x 9.5mm
Stem Length: 15mm
Lexus LX 570 and Toyota
Land Cruiser & RAV4 2013 - On

UNIT PACKAGE: 25



22350
(Toyota: 90467-A0004)
White Nylon

Headliner & Interior Trim Moulding Clip

Top Head Size: 14mm x 20mm
Bottom Head Size: 18mm x 24mm
Stem Diameter: 10mm
Stem Length: 14mm
Lexus RX 350 and Toyota
Avalon & Camry 2005 - On

UNIT PACKAGE: 25



21712
(Toyota: 52535-0E030)
White Nylon

Moulding Clip

Top Head Size: 13mm x 13mm
Stem Length: 22mm
Overall Length: 25mm
Lexus LS 600h & RX 450h and Toyota RAV4
& 4Runner 2006 - On

UNIT PACKAGE: 15



21857
(Toyota: 75392-35220)
White Nylon

Front & Rear Spoiler Moulding Clip

Head Size: 10mm x 20mm
Stem Length: 24mm
Overall Length: 27mm
Lexus HS250 & RX350 and Toyota
Camry, Corolla, FJ Cruiser &
Highlander 2010 - On

UNIT PACKAGE: 25



21505
(75545-53011)
Blue Nylon

Windshield Moulding Clip

Width: 15mm
Length: 55mm
GX 460, IS250/350, IS F 2006 - On

UNIT PACKAGE: 5



21255
(75545-53010)
Blue Nylon

Windshield Clip

Width: 15mm
Length: 55mm
ES250 & IS250 2008 - On

UNIT PACKAGE: 10

25345
(Lexus, Scion & Toyota: 56115-30100)
Black Nylon



Windshield Moulding Clip

Width: 15mm
Length: 39mm
Overall Height: 10mm
Lexus CT200h 2017 - 2011, ES300, ES350 2018 -2013,
GS300 2006 - 1998, GS400 2000 - 1998,
GS430, LS430 2006 -2001, GX460 2021 - 2010,
GX470 2009 - 2003, HS250h 2012 - 2010,
LS460 2017 - 2007, LS600h 2016 - 2008,
LX570 2021 - 2008, NX200t 2017 - 2015,
NX300 2021 - 2015, UX200, UX250 2021 - 2019;
Toyota 4Runner 1999 - On, Camry 2006 - 1999, Celica,
Echo 2005 - 2000, C-HR 2017 - On,
Corolla 2003 - On, FJ Cruiser 2014 - 2007,
Highlander, Land Crusier 2020 - 2008,
Matrix 2013 - 2003, Prius 2010 - On,
RAV4 2021 - 2001, Sequoia 2010 - 2001,
Solara 2008 - 2006, Tacoma 2020 - 2005,
Tundra 2006 - 2000, Yaris 2018 - 2007;
Scion iQ 2015 - 2012, tC 2016 - 2005,
xA 2006 - 2004, xB 2015 - 2004, xD 2014-2008

UNIT PACKAGE: 25

25429
(Lexus & Toyota: 75545-30170, 75545-0E020)
White Nylon



Windshield Moulding Clip

Width: 15mm
Length: 58mm
Overall Thickness: 5mm
Lexus ES250 2021, ES300h 2013-2021, ES350 2013-On,
GS 2016-2020, GS200t, IS200t 2016, GS300 2018-2019,
GS350 2013-2020, GS450h 2013-2018, IS 2017,
RX350, RX450h 2021 - 2016; Toyota Avalon 2021 - 2019,
Camry 2021 - 2018, Highlander 2021 - 2014,
Mirai, Venza 2021, Prius 2021 - 2016, Sienna 2021

UNIT PACKAGE: 25

22427
(Toyota: 75548-60021)
White Nylon



Rocker, Pillar, Exterior Trim & Windshield Moulding Clip

Width: 15.5mm
Length: 52mm
Lexus LX 570 & Toyota Land Cruiser 2008 - On

UNIT PACKAGE: 10



20738
(53271-44010)
Black Nylon

Headlight Bracket Clip
Width: 25mm
Length: 40.5mm
Lexus IS-300 and Toyota Camry & RAV4 2001 - On

UNIT PACKAGE: 4



21544
(90189-04102)
White Nylon

Screw Grommet with Sealer
Screw Size: M3.2 (#6)
Head Size: 10mm x 10mm
Stem Length: 15mm
Fits into 7mm Square Hole
Lexus IS 250, IS 350 & IS F
and Toyota Highlander 2006 - On

UNIT PACKAGE: 25



19783
(Ford: N811169-S, W705550-S300;
Toyota: 90075-10801, 90189-06111)
White Nylon

Head Diameter: 13mm
Stem Length: 9mm
Fits into 11mm Hole
Ford, Lexus & Toyota

UNIT PACKAGE: 50



19742
(90189-06104)
Natural Nylon

Fender Lining Screw Grommet
Screw Size: #12 (M5.5)
Head Diameter: 18mm
Stem Length: 15mm
Fits into 9mm Square Hole
Lexus IS300 and Toyota Avalon, Camry & Sienna 1997 - On

UNIT PACKAGE: 15



25431
(Lexus & Toyota: 90189-04231)
Black Nylon

Wheel Opening Screw Grommet
Screw Size: M4.2 (#8)
Head Size: 8mm x 8mm
Stem Length: 16mm
Overall Height: 17mm
Fits into 6mm Hole

Lexus GS300 2006, GS350, GS450h 2011 - 2007,
GS430 2007 - 2006, GS460 2011 - 2008,
LS460 2017 -2007, LS600hL 2016 - 2008,
NX200t 2017 - 2015, NX300, RX350L, RX450hL 2021 - 2018,
NX300h 2021 - 2015, RX350, RX450h 2021 - 2010;
Toyota Highlander 2021 - 2014

UNIT PACKAGE: 50



21625
(90189-06145)
Black Nylon

Fender Lining Screw Grommet
Screw Size: M5.5 (#12)
Head Diameter: 16mm
Stem Length: 16mm
Fits into 9mm x 9mm Hole
Lexus CT 200h and Toyota Prius, Sequoia & T-100 1993 - On

UNIT PACKAGE: 15



21605
(90189-A0002)
Black Nylon

Screw Grommet
Screw Size: M5.5 (#12)
Head Diameter: 20mm
Stem Length: 17mm
Fits into 9mm x 9mm Hole
Lexus GX460, GX470 & LX570 and
Toyota Avalon, Corolla, FJ Cruiser, RAV4, Sienna,
Tacoma & 4-Runner 1995 - On

UNIT PACKAGE: 25



25433
(Lexus & Toyota: 90189-06066)
Yellow Nylon

Fender & Side Shield Cover Screw Grommet
Screw Size: M4.8 (#10)
Head Diameter: 17mm
Stem Length: 10mm
Overall Height: 11mm
Fits into 9mm x 9mm Hole

Lexus GS Turbo 2017, RX300 2003 - 1999, IS F
2014 - 2008, IS250 2015 - 2007, LS600h 2016 - 2008,
RX350, RX450h 2016 - On, GS200t, IS200t,
RC200t 2017 - 2016, LS460 2017 - 2007, ES300h ES350,
GS450h 2018 - 2013, GS300 2019 - 2018,
GS350 2020 - 2013, RC300 2020 - 2016,
IS300 2021 - 2001, IS350 2021 - 2006, RC F,
RC350 2021 - 2015, LC500 2021 - 2018;
Scion xA 2006 - 2004; Toyota Celica 2005 - 2000,
Corolla 1988 - 1984, Mirai 2021 - On, RAV4 2014 - 2012,
Terrel 1990 - 1987

UNIT PACKAGE: 25



25432
(Lexus & Toyota: 90189-06027)
Yellow Nylon

Under Cover Screw Grommet
Screw Size: #14 (1/4") or M6.3-1.81
Head Diameter: 20mm
Stem Length: 17mm
Fits into 8mm x 8mm Hole
Lexus GS300 2005 - 1993, GS400 2000 - 1998,
GS430, IS300 2005 - 2001, SC430 2010 - 2002
Toyota 4Runner 1995 - 1984, Corolla 2013 - 2003,
Cressida 1992 - 1989, Matrix 2008 - 2003,
Pick-Up 1995 - 1984, Previa 1997 -1991, Prius 2009 - 2004

UNIT PACKAGE: 25



21682
(52197-30040)
White Nylon

Front Bumper Screw Grommet with Sealer
Screw Size: M5.5 (#12)
Head Size: 22mm x 18mm
Overall Length: 24mm

Lexus CT200h, GS300, 350, 430, 460, GS450h, HS250h, LS460, 600h, RX350 & RX450h 2006 - On

UNIT PACKAGE: 15



14273
(90189-06005)
White Nylon

Screw Grommet
Screw Size: #14 (1/4") or M6.3-1.81
Head Diameter: 18mm
Stem Length: 16mm
Fits into 8mm x 8mm Hole
Lexus & Toyota

UNIT PACKAGE: 50



14267
(90189-06013)
Black Nylon

Screw Grommet
Screw Size: #14 (1/4") or M6.3-1.81
Head Diameter: 20mm
Stem Length: 17mm
Fits into 8mm x 8mm Hole
Lexus & Toyota

UNIT PACKAGE: 25



25430
(Lexus & Toyota: 76519-60010)
Pink Nylon

Front Bumper Stay & Filler Panel Grommet

Head Size: 16mm x 16mm
Stem Length: 13.5mm
Overall Height: 15mm
Fits into 8mm Slot
Lexus LX470 2007 - 2002
Toyota Land Cruiser 2007 - 1998

UNIT PACKAGE: 25



22096
(Toyota: 52197-22020)
Black Nylon

Rear Bumper Side Bracket Screw Grommet with Sealer

Screw Size: M6.3 (#14)
Head Size: 16mm x 18mm
Stem Length: 19mm
Lexus ES 350 & HS 250h 2012 - 07
Toyota Avalon & Camry 2012 - On

UNIT PACKAGE: 15



21084
(52599-0E010)
Black Nylon

Rear Bumper Grommet with Sealer

Head Diameter: 21mm
Shoulder Diameter: 13mm
Stem Length: 27mm
RX 330, RX 350 & RX 400h 2004 - On

UNIT PACKAGE: 10



20660
(90901-89004)
Yellow Nylon

Bumper Screw Grommet with Sealer

Screw Size: M6.3 (#14)
Head Size: 16.5mm x 18mm
Stem Length: 25mm
Lexus GS300 & GS400 1998 - On

UNIT PACKAGE: 10



21015
(52535-50060, 52535-0E010)
Black Nylon

Front Bumper Screw Grommet

Screw Size: M5.5 - M6 (#12)
Head Size: 17mm x 30mm
Stem Length: 9mm
Lexus IS250, IS350, RX330 & RX350 and
Toyota Camry, Highlander & Tacoma 2001 - On

UNIT PACKAGE: 5



22051
(Toyota: 90467-11117)
White Nylon

Rear Trunk License Plate Trim Retaining Nut

Screw Size: M3.5 (#6)
Overall Height: 11.5mm
Width at Bottom: 11mm
Lexus & Toyota 2009 - 1998

UNIT PACKAGE: 15



19535
(90467-07126)
Black Nylon

Cowl Vent Pin Retainer

Head Diameter: 16mm
Stem Length: 17mm
Lexus ES300, Toyota Camry & Tercel 1995 - On

UNIT PACKAGE: 10

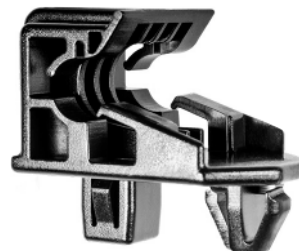

22102
(Toyota: 53271-12040;
53271-12060; 53271-0B010)
Black Nylon

Headlight Bracket Clip

Width: 25mm
Length: 39mm
Overall Height: 33mm
Lexus GX460, GX470, RX 300, RX 330 & RX 350 and
Toyota Corolla, Echo, Highlander, MR2, Prius,
Tacoma, Tercel & 4-Runner 1993 - On

UNIT PACKAGE: 10



20758

(53879-58010)
Black Nylon

Front Fender & Bumper Cover Clip

Width: 25mm
Length: 34mm

Use with Auveco 20757

Lexus and Toyota 4 Runner, Highlander, Sienna & Solara 2000 - On

UNIT PACKAGE: 5



21358

(53879-50020)
Black Nylon

Bumper Cover Clip

Width: 35mm
Length: 25mm

Use with Auveco 21357

GS, IS & LS 2007 - On

UNIT PACKAGE: 10



21357

(47749-50090)
Black Nylon

Bumper Cover Pin Retainer

Head Diameter: 10mm
Stem Length: 24mm

Use with Auveco 21358

GS, IS & LS 2007 - On

UNIT PACKAGE: 15



22944

(Lexus & Toyota: 53879-02150; 53879-02150)
Black Nylon

Bumper to Fender Liner Clip

Overall Length: 43mm
Overall Width: 39mm

Lexus ES300 & ES350 2019 - On

Toyota Camry & Corolla 2018 - On

UNIT PACKAGE: 5



22073

(Toyota: 76924-47020)
Black Nylon

Moulding Retainer

Head Diameter: 32mm

Stem Length: 12mm

Fits into 22mm Hole

Lexus CT 200h & Toyota Prius 2011 - On

UNIT PACKAGE: 15



25346

(Lexus & Toyota: 90467-22017)
Black Nylon

Rocker Moulding Retainer

Head Diameter: 32mm

Stem Size: 14mm x 21.5mm

Stem Length: 13.5mm

Fits into 22mm Hole

Lexus NX350h 2022 - On;

Toyota RAV4 2019 - On,

Venza 2021-On

UNIT PACKAGE: 25



22489

(Toyota: 53879-30050)
Black Nylon

Fender Liner Retaining Clip

Width: 42mm

Length: 29.5mm

Lexus GS F, GS 200t,

GS 350, GS 450h, IS 200t,

IS 250, IS 300, IS 350,

RC F, RC 200t, RC 300 &

RC 350 2013 - On

Toyota C-HR, Prius, Prius

Prime & Prius V 2016 - On

UNIT PACKAGE: 15



20757

(47749-58010)
Black Nylon

Front Fender & Bumper Cover Pin Retainer

Head Diameter: 15mm

Stem Length: 25mm

Use with Auveco 20758

Lexus and Toyota 4 Runner, Highlander, Sienna & Solara 2000 - On

UNIT PACKAGE: 10



22353

(Toyota: 90467-09237; Nissan: 52535-06210, 52536-06210)
Red Nylon

Body Side Retainer

Head Diameter: 20mm (with Phillips Drive)

Stem Length: 24mm

Overall Length: 26mm

Lexus GS 200h, GS 350,

GS 450h, IS 250, IS 350, RC 350,

RX 350, RX 450h,

Toyota Camry & Scion iM 2012 - On

UNIT PACKAGE: 25



25075

(Lexus & Toyota: 90467-05162-C0)
Black Nylon

Belt Mouding Retainer

Head Diameter: 12mm
Stem Size: 5mm x 5.8mm
Stem Length: 10mm
Overall Height: 12mm
Fits into 5mm Hole

Lexus ES 350 2012 - 2007; GS 200t 2019 - 2016;
GS 350 2013 - On; GX 460 2010 - On;
IS 200t 2016 - On; IS 250 2015 - 2012;
IS 350 2012 - On; LC 500 2018 - On;
LS 460 2017 - 2007; LS 600 2013 - 2008;
RC 200t 2015 - On; RC 300, RC 350 2015 - On;
RX 330 2006 - 2004; RX 350 2009 - 2007;
RX 400h 2008 - 2006; Toyota 4Runner 2010 - On;
Landcruiser 2008 - On; Matrix 2014 - 2010;
Sienna 2011 - On; Venza 2017 - 2009

UNIT PACKAGE: 25



21693

(90467-05125)
Black Nylon

Front Bumper Bracket Retainer

Head Diameter: 16mm
Stem Diameter: 4.7mm x 4.7mm
Stem Length: 12mm

Lexus GS 300, GS 450h & LS 400 1995 - On

UNIT PACKAGE: 25



22598

(Lexus: 90467-07208)
Black Nylon

Fender Seal Retainer

Head Diameter: 16mm
Stem Diameter: 8mm
Stem Length: 16mm
Fits into 8mm Hole
Lexus ES 300h, ES 350, IS F,
LS 460 & LS 600h 2013 - On

UNIT PACKAGE: 25



22369

(Toyota: 90467-08188)
Black Nylon

Luggage Compartment Trim Retainer

Head Diameter: 16mm
Stem Diameter: 8mm
Stem Length: 12mm
Lexus ES 300, LS 430 &
SC 430 2010 - 1996
Toyota Prius & Sienna 2003 - 1998;
Scion iQ 2015 - 2012

UNIT PACKAGE: 25



22473

(Toyota: 90467-A0002-C0, 90467-A0002-C4)
Black Nylon

Trunk Side Trim Retainer

Head Diameter: 16mm
Stem Diameter: 8mm
Stem Length: 16mm
Lexus ES300h, IS300, IS350, RC F, RC350
2021 - 2017, ES350 2021 - 2016, GS F, GS350,
RC300 2020 - 2017, GS Turbo, GS200t,
IS200t, LS460, RC200t 2017, GS300 2019 -
2018, GS450h 2018 - 2017, LC500, LC500h,
LS500 2021 - 2018, LS500h 2020 - 2018,
RX330 2011 - 2004, RX350 2015 - 2010
Toyota Avalon 2022 - 2013,
Camry 2022 - 2012, Corolla 2022 - 2014,
Highlander 2019 - 2015, Prius 2022 - 2017,
Sequoia 2019 - 2017, Sienna 2011 - On,
Tacoma 2022 - 2015, Tundra 2018 - On,
Matrix 2014 - 2009, Venza 2016 - 2009

UNIT PACKAGE: 25



20878

(90467-A0008)
Black Nylon

Bumper Cover Retainer

Head Diameter: 19mm
Stem Diameter: 7.5mm
Stem Length: 16mm
Lexus, Toyota & Scion 1995 - On

UNIT PACKAGE: 50



20874

(90467-07049-C0)
Black Nylon

Trim Panel Retainer

Head Diameter: 25mm
Stem Diameter: 7mm
Stem Length: 23mm
Lexus 2000 - On

UNIT PACKAGE: 25



18297

(Toyota: 90467-08004, 90467-08011)
(GM: 94842841, 94849113)
Black Nylon

Hood Seal Retaining Clip

Head Diameter: 13mm
Stem Length: 11mm
Fits into 6mm Hole
Lexus, Toyota, Geo Prizm & Nova 1985 - On

UNIT PACKAGE: 50



22497

(Toyota: 65487-60010)
Black Nylon

Hood Seal Retaining Clip

Head Size: 5mm x 13mm
Stem Diameter: 7mm
Stem Length: 8mm
Lexus CT 200h, ES 300h, ES 350, GS F, GS 200t,
GS 350, GS 450h, LC 500h & LX 570 and
Toyota Land Cruiser & Mirai 2008 - On

UNIT PACKAGE: 25



22212

(Toyota: 53145-60030)
Black Nylon

Front Bumper, Grille & Hood Seal Retaining Clip

Head Size: 4.3mm x 11mm
Stem Diameter: 6.2mm
Stem Length: 10mm

Toyota Avalon, Camry, Highlander, Land Cruiser, Prius & Venza and Lexus GS 350, GS 450h, IS 250, IS 350, LX 570, NX 200t, NX 300h, RX 350 & RX 450h and Scion iQ & tC 2008 - On

UNIT PACKAGE: 100



21643

(Toyota: 90467-08101, 90467-08108)
Black Nylon

Hood to Cowl Top Seal Retaining Clip

Head Size: 7mm x 13mm
Stem Diameter: 7.5mm
Stem Length: 13mm

Lexus ES 300, Toyota Camry 2001 - 1997, Cressida 1992 - 1989, Sequoia 2007 - 2001, Solara 2009 - 1999, Tundra 2006 - 1997, 4Runner 2010 - On, Corolla 2008 - 1998, FJ Cruiser 2014 - 2007, Highlander 2013 - 2008, Land Cruiser 2020 - 1998, Matrix 2008 - 2003, Prius 2009 - 2004, Sienna 2020 - 2011

UNIT PACKAGE: 25



21634

(90467-10186)
Black Nylon

Dash & Fender Apron Seal Retainer

Head Diameter: 16.5mm
Stem Diameter: 9mm
Stem Length: 13mm

Lexus GX 460, GX 470 & LX 470 and Toyota 4 Runner, FJ Cruiser, Land Cruiser, RAV4, Sequoia & Tundra 1996 - On

UNIT PACKAGE: 25



22395

(Toyota: 90467-09169-C0)
Black Nylon

Lower Fender Shield & Front Floor Carpet Shield Retaining Clip

Head Diameter: 18mm
Stem Length: 12mm
Fits into 7mm Hole

Lexus GX 470, RX 330 & RX 400h 2009 - 2003
Toyota 4Runner, MR2 Spyder Paseo & Tercel 2009 - 1995

UNIT PACKAGE: 15



22495

(Toyota: 90467-06205-C0)
Black Nylon

Front Fender Retaining Clip with Sealer

Head Diameter: 20mm
Stem Diameter: 8mm
Stem Length: 9mm

Lexus GS F, GS 350, GS 450h, GX 460, HS 250h, IS 200t, IS 250, IS 300, IS 350, LC 500h, RC F, RC 200t, RC 300, RC350, RX 350 & RX 450h 2010 - On
Scion iQ & xD and Toyota 4Runner & Highlander 2015 - 2008

UNIT PACKAGE: 25



25076

(Lexus & Toyota: 90467-09051)
Black Nylon

Undercover Retainer

Head Diameter: 20mm
Stem Size: 5mm x 8mm
Stem Length: 10mm

Overall Height: 12mm
Fits into 6mm Hole

Lexus GS 200t 2016; GS 300 2019 - 2018; GS 350 2013 - On; GS 430 20007 - 2006; GS 450h 2018 - 2013; GS 460 2011 - 2008; IS 200t 2017 - 2016; IS 250 2015 - 2006; IS 300 2016 - On; IS 350 2006 - On; LS 460 2017 - 2007; LS 600hl 2016 - 2008; RC 200t 2016; RC 300 2016 - On; RC 350 2015 - On; Toyota Corolla 1987 - 1984

UNIT PACKAGE: 25



19113

(90467-08124)
Black Nylon

Hood Insulation Retainer

Head Diameter: 25mm
Stem Diameter: 8mm
Stem Length: 12mm

Toyota Supra 1993-On
Lexus 1994-89

UNIT PACKAGE: 15



19729

(90467-09050)
Black Nylon

Hood Insulation Retainer

Head Diameter: 25mm
Stem Length: 10mm
Fits into 7mm Hole

Lexus, Toyota Camry & Solara 1998-On

UNIT PACKAGE: 15



21627

(67868-30030)
Black Nylon

Door & Roof Rail Retainer

Head Diameter: 9mm
Stem Diameter: 5.3mm
Stem Length: 8mm

Lexus HS 250h, IS 250, IS 350, RX 350 & 450h 2006 - On
Toyota Camry, Corolla, Corona & Land Cruiser 1999 - 74

UNIT PACKAGE: 25



21548
(67869-20030)
Black Nylon

Weatherstrip Retainer
Head Diameter: 10mm
Stem Diameter: 6mm
Stem Length: 10mm
Lexus IS 300 & SC 430 and Toyota Camry, Celica, Corolla, Highlander, Matrix, MR-2, Prius, RAV-4, Scion, Solara & Supra 1990 - On

UNIT PACKAGE: 25



21694
(67867-50020)
Black Nylon

Weatherstrip Retaining Clip
Top Head Size: 5mm x 14mm
Bottom Head Diameter: 8mm
Stem Diameter: 6.3mm
Stem Length: 5mm
Lexus GS 300 & LS 400 2005 - 1990

UNIT PACKAGE: 25



21552
(90467-04034)
White Nylon

Weatherstrip Retainer
Top Head Size: 5mm x 15mm
Bottom Head Diameter: 9mm
Stem Diameter: 6.5mm
Stem Length: 4mm
Lexus CT 200h, HS 250h, IS F, IS 250, IS 350, LS 460, LS 600h, RX 350, RX 400h & RX 450h and Toyota Avalon, Corolla, Highlander, Matrix, Prius, RAV-4, Scion & Venza 2003 - On

UNIT PACKAGE: 25



22487
(Toyota: 90467-06192)
Black Nylon

Fender Liner Retaining Clip
Head Size: 14.5mm x 16mm
Stem Diameter: 10.5mm
Stem Length: 10mm
Fits into 8mm Hole
Lexus ES 300h; ES 350; GS 200h; GS 350; GS F; GS 450h; IS 200t; IS 300, IS 350, LS 460, LS 600h L & RC F and Toyota Camry & RAV4 2006 - On

UNIT PACKAGE: 25



22103
(Toyota: 53857-47011)
Black Nylon

Front Fender Retainer with Sealer
Head Diameter: 20mm
Stem Diameter: 9mm
Stem Length: 9mm
Lexus CT 200h and Toyota Camry, Prius, RAV4, Yaris & 4-Runner 2010 - On

UNIT PACKAGE: 15



25337
(Lexus & Toyota: 76829-60020)
Green Nylon

Interior Trim Panel Retainer
Top Head Diameter: 13mm
Bottom Head Diameter: 16mm
Stem Diameter: 3.7mm
Stem Length: 11.5mm
Overall Length: 16mm

Lexus NX300 2015 - On; Toyota RAV4 2019 - On, Highlander 2020, Venza 2021 - On

UNIT PACKAGE: 50



22455
(Toyota: 90467-A0032)
White Nylon

Lower Door Moulding Retainer with Sealer
Top Head Diameter: 10mm
Bottom Head Diameter: 15mm
Stem Diameter: 8.3mm x 8.3mm
Stem Length: 10mm
Toyota RAV4 2014 - On

UNIT PACKAGE: 25



22056
(Toyota: 75867-30130)
White Nylon

Rocker Moulding Retainer with Sealer
Top Head Diameter: 13mm
Bottom Head Diameter: 18mm
Stem Diameter: 8.5mm x 8.5mm
Stem Length: 13mm
Lexus CT 200h, ES 300h, ES 350, GS 300, GS 350, GS 430, GS 460, GS 450h, HS 250h, IS 250, IS 350, IS F, LS 460, LS 600h & LX 570 and Toyota Land Cruiser 2006 - On

UNIT PACKAGE: 25



22471
(Toyota: 90467-A0007)
White Nylon

Scuff Plate Retainer
Top Head Diameter: 13mm
Bottom Head Diameter: 18mm
Stem Diameter: 9.3mm
Stem Length: 11mm
Lexus RX 330, RX 350 and RX 450h and Toyota Avalon, Camry, Matrix, Sequoia, Sienna & Tundra 2004 - On

UNIT PACKAGE: 25



21012
(75867-AA010)
Black Nylon

Rocker Panel & Scuff Plate Retainer
Top Head Diameter: 13mm
Bottom Head Diameter: 18mm
Stem Diameter: 9.5mm
Stem Length: 14mm
Lexus ES300 & ES330 2002 - On
Toyota Avalon, Camry, Scion & Solara 2004 - On

UNIT PACKAGE: 15



21795
(Toyota: 67773-0E020)
White Nylon

Door Panel Retainer with Sealer
Top Head Diameter: 13mm
Bottom Head (Including Sealer) Diameter: 18mm
Overall Length: 20mm
Fits into 8.5mm Hole
Lexus RX350 2009 and
Toyota Camry 2012 - On

UNIT PACKAGE: 25



20473
(67771-12070)
White Nylon

Door Panel & Rocker Moulding Retainer with Sealer
Top Head Diameter: 13mm
Bottom Head Diameter: 18mm
Stem Diameter: 11mm
Stem Length: 14mm
Lexus SC300/400 Toyota Avalon & Corolla 1992 - On

UNIT PACKAGE: 15



20558
(62217-13010)
White Nylon

Garnish Moulding Retainer
Top Head Diameter: 13mm
Middle Head Diameter: 16mm
Bottom Head Diameter: 15mm
Stem Diameter: 10mm
Stem Length: 11mm
Overall Length: 17mm
Lexus and Toyota Corolla, Matrix & 4 Runner 2003 - On

UNIT PACKAGE: 25



20575
(67771-12080)
Yellow & White Nylon

Door Panel & Rocker Moulding Retainer
Top Head Diameter: 13mm
Middle Head Diameter: 16mm
Bottom Head Diameter: 18mm
Stem Diameter: 10mm
Stem Length: 13mm
Overall Length: 20mm
Toyota & Lexus 1998 - On

UNIT PACKAGE: 15



22334
(Toyota: 53857-0E010)
Black Nylon

Front Fender Retainer with Sealer
Top Head Diameter: 20mm
Bottom Head Diameter: 18mm
Stem Diameter: 12mm
Stem Length: 15mm
Overall Height: 31.5mm
Toyota Highlander 2015 - On

UNIT PACKAGE: 10



20559
(GM: 88970345;
Toyota: 90467-10167)
Blue Nylon

Garnish Moulding Retainer
Top Head Diameter: 13mm
Middle Head Diameter: 16mm
Bottom Head Diameter: 18mm
Stem Diameter: 9mm x 9mm
Stem Length: 11mm
Overall Length: 18mm
Pontiac Vibe, Lexus and Toyota 2000 - On

UNIT PACKAGE: 25



22335
(Toyota: 52599-48020)
Black Nylon

Rear Bumper Retainer with Sealer & Stainless Steel Screw
Head Diameter: 22mm
(with Black Finish Stainless Steel Tapping Screw)
Shoulder Diameter: 13mm
Stem Length: 27mm
Toyota Highlander 2007 - 01
Venza 2009 - On

UNIT PACKAGE: 5



21102
(90467-A0005)
White Nylon

Door Trim Panel Retainer with Sealer
Top Head Diameter: 13mm
Middle Head Diameter: 16mm
Bottom Head Diameter: 18mm
Stem Diameter: 8.5mm
Stem Length: 14mm
Lexus ES 350, GX 470, IS 250, IS 350, IS F, LS 460 & LS 600HL and Toyota Camry, FJ Cruiser, Highlander, RAV4 & 4-Runner 2001 - On

UNIT PACKAGE: 15



22486

(Toyota: 67771-26240)
Blue Nylon

Door Trim Retainer with Sealer

Top Head Diameter: 13mm
Middle Head Diameter: 16mm
Bottom Head Diameter: 18mm
Stem Diameter: 9.6mm
Stem Length: 10mm
Overall Length: 16.5mm
Lexus CT 200h, ES 300h, ES 350, GS 200t, GS 350, IS 200t, IS 250, IS 300, LC 500h, LS 460, NX 200t, NX 300h, RC 200t, RC 300, RC 350, RX 350 & RX 450h and Toyota FJ Cruiser, Prius C & Prius V 2006 - On

UNIT PACKAGE: 25



19257

(67771-12050)
Nylon

Front & Rear Door Trim Board Retainer

Top Head Diameter: 13mm
Bottom Head Diameter: 18mm
Stem Diameter: 9mm
Stem Length: 14mm
Overall Length: 20.5mm
Lexus and Toyota Celica, Corolla & Previa 1990-On

UNIT PACKAGE: 15



22845

(Toyota: 90467-09232)
Red Nylon

Trim Panel Retainer

Top Head Diameter: 13mm
Middle Head Diameter: 16mm
Bottom Head Diameter: 18mm
Stem Diameter: 9mm
Stem Length: 15mm
Lexus IS 250 & IS 350 2015 - 2010
LC 500, LC 500h, LS 500, LS 500h, NX 200t, NX 300 & NX 300h and Toyota Highlander & Tacoma 2014 - On

UNIT PACKAGE: 25



22460

(Toyota: 62489-0E010)
White Nylon

Door Sill, Headliner, Liftgate Trim Cover, Pillars, Scuff Plate & Window Trim Retainer

Top Head Diameter: 13mm
Middle Head Diameter: 16mm
Bottom Head Diameter: 18mm
Stem Diameter: 11mm
Stem Length: 14mm
Overall Length: 20mm
Lexus RX 350 & RX 450h 2015 - 2010
Toyota Avalon, Corolla, Highlander, RAV4, Sienna & Venza 2013 - On

UNIT PACKAGE: 25



22125

(Toyota: 90467-05170)
Black Nylon

Front Bumper Push-Type Retainer

Head Diameter: 10mm
Stem Length: 10mm
Fits into 5mm Hole
Lexus IS 250, IS 350 & NX 300h and Toyota Corolla, Highlander, Matrix & RAV4 2012 - On

UNIT PACKAGE: 25



21849

(Toyota: 90467-05136)
Black Nylon

Inner Door Lock Plate, Engine Cover & Outside Air Duct Push-Type Retainer

Head Diameter: 13mm
Stem Length: 15mm
Fits into 5.5mm Hole
Lexus & Toyota 2012 - On

UNIT PACKAGE: 25



17439

(90467-09093)
Black Nylon

Bumper Cover Push-Type Retainer

Head Diameter: 15mm
Stem Length: 27mm
Fits into 9mm Hole
LS-400

UNIT PACKAGE: 10



21624

(90467-10206)
Black Nylon

Cowl Push-Type Retainer

Head Diameter: 16mm
Stem Length: 10mm
Fits into 8mm Hole
Lexus ES 350, RX 350 & RX 450h and Toyota Camry, Sequoia, Tundra & Yaris 2006 - On

UNIT PACKAGE: 15



18939

(90467-09101)
Black Nylon

Bumper Cover Push-Type Retainer

Head Diameter: 18mm
Stem Length: 23mm
Fits into 9mm Hole
ES300 1993-On

UNIT PACKAGE: 25



22400

(Toyota: 90467-07217)
Black Nylon

**Radiator Support Access Cover,
Air Deflector & Side Shield
Push-Type Retainer**
Head Diameter: 19mm
Stem Length: 9mm
Fits into 7mm Hole
Lexus LX, IS, GS, RX 350 &
RX 450h and Toyota Camry, Corolla,
Land Cruiser Prius, RAV4
& Yaris 2010 - On

UNIT PACKAGE: 25



17988

(90467-09143)
Black Nylon

Push-Type Retainer
Head Diameter: 19mm
Stem Length: 26mm
Fits into 9mm Hole
Lexus 1990-On

UNIT PACKAGE: 10



20577

(GM: 88970494;
Toyota: 90467-07168)
Black Nylon

**Rocker Panel & Garnish Moulding
Push-Type Retainer**
Head Diameter: 20mm
Stem Length: 8mm Excluding Pin
Fits into 7mm Hole
Pontiac Vibe 2004 - 2003
Lexus & Toyota 2000 - On

UNIT PACKAGE: 15



17992

(90467-07138)
Black Nylon

Push-Type Retainer
Head Diameter: 20mm
Stem Length: 12mm
Fits into 7mm Hole
Lexus 1990-On

UNIT PACKAGE: 10



19219

(90467-09096)
Black Nylon

**Front Bumper
Push-Type Retainer**
Head Diameter: 15mm
Stem Length: 27mm
Fits into 9mm Hole
LS400 1993-On
Toyota Celica & Supra 1989-On

UNIT PACKAGE: 10



18270

(90467-07117)
Black Nylon

Push-Type Retainer
Head Diameter: 17mm
Stem Length: 9mm
Fits into 7mm Hole
Lexus 1990-On

UNIT PACKAGE: 10



20869

(GM: 88970767;
Toyota: 90467-10183)
Black Nylon

Front Fender Liner Push-Type Retainer
Head Diameter: 18mm
Stem Length: 7.5mm
Fits into 7mm Hole
Lexus, Pontiac Vibe, and Toyota Celica,
Corolla, Matrix & Solara 1999 - On

UNIT PACKAGE: 10



20349

(Toyota: 90467-08185;
Nissan: 01553-09611)
Black Nylon

Bumper Clip Push-Type Retainer
Head Diameter: 18mm
Stem Length: 10mm (Excluding the Pin)
Fits into 8mm Hole
Lexus & Toyota 2002 - On
Nissan 1994 - On

UNIT PACKAGE: 15



21547

(90467-09185)
Black Nylon

Front Spoiler & Grille Push-Type Retainer
Head Diameter: 18mm
Stem Length: 10mm
Fits into 9mm Hole
Lexus HS 250h and Toyota Celica,
Sequoia, Sienna & 4-Runner 1994 - On

UNIT PACKAGE: 25



21702

(Toyota: 90467-10170-C0)
Black Nylon

**Cowl Vent, Upper Radiator Cover &
Wheel Apron Push-Type Retainer**
Head Diameter: 18mm
Stem Length: 12mm
Fits into 10mm Hole
Lexus LS 460, LS 600, RX 350
& RX 450 and Toyota RAV4 2006 - On

UNIT PACKAGE: 10



21201

(90467-07211)
Black Nylon

**Bumper, Radiator Cover & Grille
Push-Type Retainer**

Head Diameter: 19mm
Stem Length: 8mm
Fits into 7mm Hole
Lexus IS & LS, Scion and Toyota
Avalon, Camry & Highlander 2005 - On

UNIT PACKAGE: 10



21525

(53259-0E010)
Black Nylon

Front Inner Structure Push-Type Retainer

Head Diameter: 19mm
Stem Length: 9mm
Fits into 7mm Hole
Lexus EX 350, IS 250, IS 350,
RX 330 RX350 & RX 400h 2004 - On

UNIT PACKAGE: 15



25338

(Lexus & Toyota: 90467-07222)
Black Nylon

**Mud Guard & Rocker Panel
Moulding Extension Push-Type Retainer**

Head Diameter: 19mm
Stem Length: 17mm
Stem Diameter: 7mm
Fits into 7mm Hole
Panel Range: 5.5mm
Lexus ES300, 350 2020-2019,
Toyota Avalon 2019-On, Camry 2018-On,
Prius 2016-On

UNIT PACKAGE: 25



20955

(90467-07201)
Black Nylon

**Engine Under Cover
Push-Type Retainer**

Head Diameter: 20mm
Stem Length: 10mm
Fits into 7mm Hole
Lexus ES300/330 and
Toyota Avalon, Camry &
Solara 2002 - On

UNIT PACKAGE: 10



22567

(Toyota: 90467-07220)
Black Nylon

**Bumper Cover, Radiator Support,
Under Cover & Wheel Opening
Push-Type Retainer**

Head Diameter: 20mm
Stem Length: 12mm
Fits into 7mm Hole
Lexus CT 200h, GX 460, IS 300, IS 350,
LC 500h, NX 200t, NX 300h, RX 350
& RX 450h and Toyota 4Runner, C-HR,
Camry, Corolla, Corolla iM, Prius, Prius
Prime, Prius V & RAV4 2013 - On
Scion iM, tC & xB 2016 - 2008

UNIT PACKAGE: 25



19239

(GM: 11519949;
Honda: 91512-SX0-003;
Mitsubishi: MU000319;
Lexus & Toyota: 90467-08217)
Black Nylon

**Front Fender, Bumper Support, Interior
Trim & Washer Tank Push-Type Retainer**

Head Diameter: 20mm
Stem Length: 11mm
Fits into 8mm Hole
Acura 3.5RL, Honda Accord, Prelude &
Odyssey 1994 - On; Mitsubishi Lancer 2002 - On;
GM 1997 - On; Lexus GX470 2009 - 2003;
Toyota 4Runner 2009 - 2003, FJ Cruiser 2014 - 2007,
Tacoma 2016 - 2005

UNIT PACKAGE: 25



21856

(Toyota: 51454-48010,
51454-0E010)
Black Nylon

**Front Bumper Extension Mounting
Bracket Push-Type Retainer**

Head Diameter: 20mm
Stem Length: 12mm
Fits into 10mm Hole
Lexus IS CV, F, RX330 & RX400 Hybrid 2006 - On
Toyota Highlander, Sienna & Venza 2009 - On

UNIT PACKAGE: 15



25259

(Toyota: 90467-10216)
Black Nylon

**Fender Apron & Interior
Trim Push-Type Retainer**

Head Diameter: 20mm
Stem Length: 13mm
Fits into 10mm Hole
Toyota Avalon, RAV4 2013 - On, Camry 2018 - On,
CH-R 2017 - On, Corolla 2019 - On,
Highlander 2014 - On; Land Crusier 2016 - On,
Mirai, Sienna, Venza 2021 - On, Prius 2012 - On,
Yaris 2018 - 2015, Scion iQ 2013

UNIT PACKAGE: 25



21596
(75867-06030)
Black Nylon

Rocker Panel Push-Type Retainer
Head Diameter: 20mm
Stem Length: 16mm
Fits into 8mm Hole
Toyota & Lexus 2007 - On

UNIT PACKAGE: 25



21860
(Toyota: 51453-48010,
51453-0E010)
Black Nylon

**Front Side Lower Fender Panel
Bracket Push-Type Retainer**
Head Diameter: 22mm
Stem Length: 14mm
Fits into 13mm Hole
Lexus RX330 2009-2004
Toyota Highlander 2010 - On

UNIT PACKAGE: 15



22568
(Toyota: 90467-09242)
Black Nylon

**Cowl Grille
Push-Type Retainer**
Head Diameter: 22mm
Stem Length: 15mm
Fits into 9mm Hole
Lexus RX 350 & RX 450h and
Toyota C-HR, Camry, Prius,
Prius Prime & Yaris 2016 - On

UNIT PACKAGE: 15



22502
(Toyota: 76923-52021)
Black Nylon

**Side Mud Guard
Push-Type Retainer**
Head Diameter: 29mm
Stem Length: 10mm
Fits into 22mm Hole
Lexus GS F, GS 200t, GS 350, GS 450h, IS 200t, IS 250, IS
300, IS 350, RC F, RC 200t, RC 300 & RC 350 2013 - On
Toyota Yaris 2011 - 2007; Scion xD 2014 - 2008

UNIT PACKAGE: 15



22072
(Toyota: 76923-47010)
Black Nylon

**Rocker Moulding
Push-Type Retainer**
Head Diameter: 38mm
Stem Length: 32mm
Fits into 22mm Hole
Lexus HS 250h & CT 200h
and Toyota Prius 2010 - On

UNIT PACKAGE: 5



22708
(Toyota: 90467-14053)
Black Nylon

Floor Under Cover Nut
Hex: 12mm
Flange O.D.: 23.8mm
Overall Height: 11mm
Fits onto 6mm Stud

Use with Auveco Nos. 22709 & 22843

Lexus ES 300h, ES 350, GS F, GS 200t, GS 300, GS 350,
GS 430, GS 450h, GS 460, HS 250h, IS F, IS 200t, IS 250, IS
300, IS 350, LC 500, LC 500h, LS 430, LS 460, LS 500h, LS
600h L, RC F, RC 200t, RC 300, RC 350, RX 350, RX 350L,
RX 450h, RX 450h L & SC 430 and
Toyota Avalon, Camry, Corolla, Corolla iM, Highlander,
Prius, Prius C, Prius V, RAV4 &
Venza and Scion iM & xB 2006 - On

UNIT PACKAGE: 15



22843
(Toyota: 90561-A0001)
White Nylon

Under Cover Nut Spacer
Outside Diameter: 16mm
Inside Diameter: 12.5mm
Flange Diameter: 23.5mm
Height: 5.5mm

Use with Auveco No. 22708

Lexus ES 300h, ES 350, LS 500, RX 350L & RX 450hL and
Toyota Avalon, Camry & Highlander 2012 - On

UNIT PACKAGE: 15



22709
(Toyota: 90561-13003)
Black Nylon

Floor Under Cover Nut Spacer
Outside Diameter: 16mm
Inside Diameter: 12.5mm
Flange Diameter: 23.5mm
Height: 5.5mm

Use with Auveco No. 22708

Lexus ES 300h, ES 350, GS F, GS 200t, GS 300, GS 350,
GS 430, GS 450h, GS 460, HS 250h, IS F, IS 200t, IS 250, IS
300, IS 350, LC 500, LC 500h, LS 430, LS 460, LS 500h, LS
600h L, RC F, RC 200t, RC 300, RC 350, RX 350, RX 350L,
RX 450h, RX 450h L & SC 430 and Toyota Avalon, Cam-
ry, Corolla, Corolla iM, Highlander, Prius, Prius C, Prius V,
RAV4 & Venza and Scion iM & xB 2006 - On

UNIT PACKAGE: 15



20469
(69293-12030)
Natural Nylon

Door Lock Rod Clip
Rod Size: 5mm
Right (Passenger) Side
Lexus ES 300 2001 - 97

Toyota Camry, Celica, Corolla, Echo, Highlander, MR2,
RAV4, Tundra and 4-Runner 1994 - On

UNIT PACKAGE: 10



20470

(69293-12040)
Yellow Nylon

Door Lock Rod Clip

Rod Size: 5mm
Left (Driver) Side

Lexus ES 300 2001 - 97

Toyota Camry, Celica, Corolla, Echo, Highlander, MR2, RAV4, Tundra and 4-Runner 1994 - On

UNIT PACKAGE: 10



20534

(69293-12050)
Natural Nylon

Door Lock Rod Clip

Rod Size: 5mm
Fits into 8.5mm Hole
Right (Passenger) Side

Lexus ES250, 300 & RX300 and Toyota Tacoma 1990 - On

UNIT PACKAGE: 10



20535

(69293-12060)
Yellow Nylon

Door Lock Rod Clip

Rod Size: 5mm
Fits into 8.5mm Hole
Left (Driver) Side

Lexus ES250, 300 & RX300 and Toyota Tacoma 1990 - On

UNIT PACKAGE: 10



21336

(69293-30030)
Natural Nylon

Door Lock Rod Clip

Rod Size: 5mm
Fits into 8mm Hole
Overall Height: 20mm
Toyota & Lexus 1993 - On

UNIT PACKAGE: 10



22483

(Mazda: S47P-64-345;
Mitsubishi: MQ907568)
White Nylon

Instrument & Side Panel Clip

Width (Ear to Ear): 10.3mm
Overall Height: 18.6mm
Mazda 2, 3, 5, 6, CX-5, CX-7, CX-9,
Miata, MPV, Protégé & RX-8
and Mitsubishi 2000 - On

UNIT PACKAGE: 25



20380

(Not Supplied by O.E.M.)
Black Nylon

Photo not actual size

Cable Strap

Length: 200mm (8")
Max. Bundle Diameter: 44mm (1-3/4")
Fits into 6.3mm (1/4") Hole
Import Cars

UNIT PACKAGE: 25



22097

(Toyota: 90950-01620)
Black Nylon

Hole Plug

Head Diameter: 30mm
Height: 5.6mm
Fits into 22mm Hole

Lexus ES, RX & SC; Scion iQ, tC, xA, xB & xD; Toyota Avalon, Camry, Celica, Corolla, FJ Cruiser, Highlander, Matrix, Prius, RAV4, Sequoia, Sienna, Tacoma, Tundra & Yaris 1984 - On

UNIT PACKAGE: 15



25435

(Lexus & Toyota: 90467-06183)
Black Nylon

Interior Cowl Trim Nut

Thread Size: M6-1.0
Head O.D.: 19mm
Head Height: 13mm
Overall Height: 24.5mm

Lexus GX460 2021 - 2010, GX470 2009 - 2003, LX470 2007 - 1998; Toyota 4Runner 2003 - On, FJ Cruiser 2014 - 2007, Land Cruiser 2007 1998, Tacoma 2016 - 2005

UNIT PACKAGE: 15



25434

(Lexus & Toyota: 90467-06158-C0)
Black Nylon

Interior Cowl Trim Nut

Thread Size: M5-0.8
Flange O.D.: 20mm
Hex Size: 12mm
Height: 21mm

Lexus ES300 2001 - 1993, ES350 2015 - 2013, GS200t 2016, GS300 2019 - 2018, GS350, GS450h 2019 - 2013 & 2011 - 2007, GS430 2007 - 2006, GS460 2011 - 2008, IS300 2005 - 2002, LS500 2018 - On; Scion tC 2010 - 2005; Toyota Avalon 2004 - 1995, Camry 2004 - 2001, Celica 1997 - 1994, Corolla 2019 - 2014, Land Cruiser 2021 - 2008, Prius 2015 - 2010, RAV4 2021 - 2019, Sienna 2003 - 1998, Solara 2003 - 1999

UNIT PACKAGE: 25



21615

(90467-A0018, 90467-05081)
Maroon Nylon

Left & Right Front Bumper & Bumper Stay Nylon U-Nut

Screw Size: M6 (#14)

Panel Range: Up to 2mm

Center of Hole to Edge: 12mm

Lexus and Toyota Avalon, Camry & Solara 2000 - On

UNIT PACKAGE: 15



17993

(90179-05060)
Black Nylon

Nylon U-Nut

Screw Size: #10

Width: 18mm Wide

Length: 27mm

Panel Range: Up to 3mm

Center of Hole to Edge: 14mm

Lexus 1990-On

UNIT PACKAGE: 10



21359

(53879-17020)
Black Nylon

Bumper & Fender Apron Nylon U-Nut

Screw Size: M4.8 (#10)

Panel Range: Up to 2mm

Center of Hole to Edge: 10mm

Lexus GS, IS, LS & SC and Toyota Celica 2000 - On

UNIT PACKAGE: 10



20956

(90467-05114)
Black Nylon

Bumper & Fender Apron Nylon U-Nut

Screw Size: M5.5 (#12)

Width: 20mm

Length: 36mm

Panel Range: Up to 1mm

Center of Hole to Edge: 14mm

Lexus & Toyota 2000 - On

UNIT PACKAGE: 10



21687

(Toyota: 90467-05138)
Black Nylon

Front Bumper & Fender Liner Nylon U-Nut

Screw Size: M6.3 (#14)

Panel Range: Up to 3mm

Center of Hole to Edge: 14mm

Lexus GX 460, GX 470 & LX 570, Scion tC and Toyota Corolla, FJ Cruiser, Land Cruiser, Matrix, Sequoia, Tacoma, Tundra & 4 Runner 2003 - On

UNIT PACKAGE: 15



1928
(NA01-50-101A)
Nylon

Bumper Clip
Miata 1992-On

UNIT PACKAGE: 10



21561
(E11451W24)
White Nylon

Moulding Clip
Top Head Size: 10mm x 15mm
Bottom Head Diameter: 17mm
Stem Diameter: 13mm
Stem Length: 9mm
CX-7 2007 - On

UNIT PACKAGE: 25



18882
(Ford: KA80-51-PR6;
Mazda: EA01-50-048)
Black Nylon

**Body Side Lower
Wide Moulding Grommet**
Ford Probe &
Mazda MX6 1993-On

UNIT PACKAGE: 10



22520
(Mazda: KD53-51-SJ3A)
Gray Nylon

**Stone Guard
Moulding Clip with Sealer**
Top Head Size: 10mm x 15mm
Bottom Head Diameter: 18mm
Stem Diameter: 12mm
Stem Length: 9mm
Mazda CX-5 2016 - On

UNIT PACKAGE: 25



22511
(Mazda: D10E-51-SJ3)
Green Nylon

**Rocker Panel Moulding
Retainer with Sealer**
Top Head Size: 13mm x 17mm
Bottom Head Diameter: 18.5mm
Stem Diameter: 11.7mm
Stem Length: 12mm
Mazda 3, 5, CX-3, CX-9, Miata
& MX-5 2016 - On

UNIT PACKAGE: 15



21171
(BP4L-51-SJ3)
Gray Nylon

Photos not actual size

Moulding Clip with Sealer
Top Head Size: 14mm x 20mm
Bottom Head Diameter: 36.5mm
Stem Length: 10mm
3, 5, 6, CX-7, CX-9 &
RX-8 2004 - On

UNIT PACKAGE: 10



25099
(Mazda: G22C-51-SJ3)
White Nylon

Rocker Moulding Clip with Sealer
Top Head Size: 14mm x 20mm
Bottom Head Diameter: 27mm
Stem Size: 19mm x 22mm
Stem Length: 11mm
Overall Height: 17mm
Mazda 6 2008 - 2003, RX8 2011 - 2009

UNIT PACKAGE: 25



22593
(Mazda: KD45-51-W24)
White Nylon

**Fender & Wheel Apron Moulding
Clip With Sealer**

Top Head Size: 14mm x 18mm
Bottom Head Diameter: 18mm
Stem Length: 12mm
Stem Diameter: 11mm
Mazda CX-5 2016 - 2013

UNIT PACKAGE: 25



22758
(Mazda: KB8A-51-SJ3)
Yellow Nylon

**Liftgate Moulding & Spoiler Retainer
with Sealer**

Top Head Size: 11mm x 14mm
Bottom Head Diameter: 25mm
Stem Diameter: 8mm x 10mm
Stem Length: 10mm
Mazda CX-5 2017 - On

UNIT PACKAGE: 25



20958
(GJ6A-68-162)
White Nylon

Windshield Garnish Moulding Retainer
Top Head Size: 10mm x 13mm
Bottom Head Diameter: 16mm
Stem Length: 33mm
Fits into 10mm Hole
3,5 & RX8 2004 - On

UNIT PACKAGE: 10



20960
(GM9E-63-938A)
White Nylon

Windshield Moulding Clip
Head Size: 17mm x 20mm
Stem Length: 21mm
Fits into 8mm Hole
Mazda 6 2003 - On

UNIT PACKAGE: 10



20957
(G6JA-50-0Z5)
Natural Nylon

Front Bumper Screw Grommet
Screw Size: M4.2 (#8)
Head Size: 23mm x 24mm
Stem Length: 14mm
Miata, MPV, RX8 3, 5 & 6 2000 - On

UNIT PACKAGE: 15



20984
(BC1M-50-0Z5)
Natural Nylon

Front Bumper Screw Grommet
Screw Size: M4.2 (#8)
Head Size: 24mm x 28mm
Stem Length: 14mm
323, 626, Miata MPV & Protégé 1995 - On

UNIT PACKAGE: 10



13930
(Nissan: 96706-B0700;
Mazda: 9991-00-412)
Natural Nylon

Screw Size: #8
Width: 9.5mm
Length: 9.5mm
Snaps into 7mm x 7mm Hole

UNIT PACKAGE: 50



14255
(Mitsubishi: MS-480001;
Honda: 75522-611-000;
Mazda: 9991-00-412)
Black Nylon

Screw Size: #8
Width: 9.5mm
Length: 9.5mm
Snaps into 7mm x 7mm Hole

UNIT PACKAGE: 50



14274
(Mazda: 9991-00-601;
Honda: 75521-611-000;
Nissan: 96706-P0105;
Toyota: 90189-06010)
Natural Nylon

Screw Size: #10
Width: 13mm
Length: 13mm
Snaps into 8.5mm x 8.5mm Hole

UNIT PACKAGE: 25



14313
(Mazda: 9991-00-503)
Honda: 90662-671-003;
Nissan: 62698-V7000, 68425-H5000)
Natural Nylon

Screw Size: #10
Width: 17mm
Length: 17mm
Snaps into 8mm x 8.5mm Hole

UNIT PACKAGE: 25



14366
(9991-00-402)
Natural Nylon

Screw Grommet
Screw Size: #6
Width: 9.5mm
Length: 9.5mm
Stem Length: 16mm
Fits into 7mm x 7mm Hole
Also for Nissan/Datsun

UNIT PACKAGE: 50



14695
(Mazda: H001-50-841;
Honda: 90661-SC7-003;
Mitsubishi: MS-480012;
Nissan: 01651-00481, 74798-S9000;
Toyota: 90189-06042)
White Nylon

Screw Grommet
Screw Size: #8
Head Diameter: 16mm
Stem Length: 17mm
Fits into 8mm x 8mm Hole

UNIT PACKAGE: 25



21743
(GJ6A-58-975)
White Nylon

Screw Grommet with Sealer
Screw Size: M4.2 (#8)
Head Diameter: 20mm
Stem Length: 15mm
RX-8 2010 - 04

UNIT PACKAGE: 10



22064
(H260-50-6K8)
White Nylon

Screw Grommet with Sealer
Screw Size: M4.2-1.41 (#8)
Head Size: 16mm x 22mm
Stem Length: 20mm
Mazda MPV, MX-6, RX-8, 3, 6 & 626 2010 - 1988

UNIT PACKAGE: 15



25056
(Mazda: GA7B-51-146)
Natural Nylon

Tail Light Grommet with Sealer
Head Diameter: 18mm
Stem Length: 14mm
Overall Height: 15.8mm
Fits into 8mm Hole
Mazda 2 2014 - 2011; 3 2014 - On;
6 2003 - On; CX-3 2016 - On; CX-30 2020 - On;
CX-5 2017 - On; CX-9 2016 - On;
Miata 2005 - 1999; Millenia 2002 - 1995;
MPV 2006 - 2000; MX-5 Miata 2015 - 2006;
Protégé 2003 - 1995; RX-8 2011 - 2004

UNIT PACKAGE: 25



25071
(Mazda: GJ6A-51-14Y)
Natural Nylon & Black Screw

Tail Lamp Phillips Truss Head Screw & Grommet
Screw Size: M5 x 20mm
Head Diameter: 15mm
Flange Size: 18mm
Stem Length: 10mm
Fits into 8.5mm Hole
Overall Height: 17mm
Mazda 2 2014 - 2011; 3 2018 - 2014;
5 2015 - 2008; 6 2019 - 2003; CX-3,
CX-9, MX-5 Miata 2019 - 2016;
CX-5 2019 - 2013; CX-7 2012 - 2007

UNIT PACKAGE: 15



25074
(Mazda: LA01-51-958)
Clear Nylon

Emblem Tubular Nut with Sealer
Stud Size: 2.5mm
Head Diameter: 8mm
Fits into 6mm Hole
Mazda 626 2002 - 1993; 929 1995 - 1992;
CX-3 2019 - 2016; CX-7, CX-9 2009 - 2007; 2 2013 - 2011;
3 2018 - 2004; 6 2019 - 2003; Miata 2013 - 2006; Millenia
2002 - 1995; MPV 2006 - 1989;
MX-3 1996 - 1992; MX-5 Miata 2019 - 2015;
MX-6 1997 - 1993; Protégé 2003 - 1995

UNIT PACKAGE: 25



25114
(Mazda: 9957-83-000)
Stainless Steel

Emblem Push Nut
3.5mm Stud
Outer Diameter: 12mm
Mazda CX3 2019 - 2016,
MX5 Miata 2019 - 2013,
RX8 2011 - 2009

UNIT PACKAGE: 50



22517
(Mazda: G46L-50-EB1)
Black Nylon

Grille Emblem Clip
Head Size: 9mm x 22mm
Stem Width: 9mm
Stem Length: 13mm
Mazda 3, CX-3, CX-5
& CX-9 2016 - On

UNIT PACKAGE: 25



14367
(9924-90-512B)
Black Nylon

Retainer
Head Diameter: 12mm
Stem Diameter: 5mm
Stem Length: 12mm
Panel Thickness: 2mm

UNIT PACKAGE: 50



21307
(BP4K-58-762)
Black Nylon

Weatherstrip Retaining Clip
Head Diameter: 9mm
Stem Diameter: 5.5mm
Stem Length: 7mm
Mazda 2007 - On

UNIT PACKAGE: 25



21520
(J001-56-741)
Black Nylon

Weatherstrip Retaining Clip

Head Diameter: 14mm
Stem Diameter: 6.5mm
Stem Length: 10mm
CX-7, Millenia, MPV, 3, 6 & 626 1995 - On

UNIT PACKAGE: 25



18458
(Ford: FICZ-16774-A;
Mazda: B455-56-741)
Black Nylon

Hood Insulation Retaining Clip

Head Diameter: 14mm
Stem Length: 10mm
Fits into 6mm Hole
Ford Probe & Mazda MX6 1992-88

UNIT PACKAGE: 25



14349
(Mazda: 9926-40-543;
Nissan: 01553-00291)
Black Nylon

Retaining Clip

Head Diameter: 11mm
Stem Length: 15mm
Panel Thickness: 5mm
Fits into 5.5mm Hole

UNIT PACKAGE: 50



18271
(9926-40-531B)
Black Nylon

Hood Insulation Retainer

Head Diameter: 14mm
Stem Diameter: 6mm
Stem Length: 15mm

UNIT PACKAGE: 25



17453
(B003-68-865-96)
Gray Nylon

Rear Compartment Interior Trim Retainer

Head Diameter: 15mm
Stem Length: 14mm
Stem Diameter: 6.5mm
Ford Probe and Mazda MX6 1988-On

UNIT PACKAGE: 50



21755
(B003-68-865-00)
Black Nylon

Trim Panel Retainer

Head Diameter: 15mm
Stem Diameter: 6.5mm
Stem Length: 14mm
MPV 1998 - 89

UNIT PACKAGE: 50



14709
(Mazda: G030-68-885-B-38;
Ford: F22Z-16774-A, GA2A-56694)
Black Nylon

Hood Insulation Retainer

Head Diameter: 20mm
Stem Length: 9mm
Fits into 6mm Hole

UNIT PACKAGE: 25



21661
(TD11-56-694)
Black Nylon

Hood Insulation Retainer

Head Diameter: 20mm
Stem Diameter: 7mm
Stem Length: 10mm
3, 5, 6, CX7, CX9, MX-5 Miata & RX8 2004 - On

UNIT PACKAGE: 25



21560
(G032-68-865A-00)
Black Nylon

Trunk & Carpet Retainer

Head Diameter: 20mm
Stem Diameter: 7mm
Stem Length: 15mm
B2000, B2600, CX-7, CX-9, Miata, Millenia, MX-3, MX-5, MX-6, Protege, RX-7, RX-8, 3, 5, 6, 626 & 929 1987 - On

UNIT PACKAGE: 25



18692
(Mazda: G031-58-762;
Toyota: 67867-89103,
97868-89101)
Natural Nylon

Weatherstrip Retainer

Head Size: 5mm x 15mm
Stem Length: 10mm
Fits into 5mm Hole
Toyota 4-Runner 1989-83, Mazda 1996-On

UNIT PACKAGE: 50



25072
(Mazda: KD45-58-762)
White Nylon

Weatherstrip Retainer

Head Size: 5mm x 11mm
Stem Length: 10mm
Fits into 5mm Hole
Overall Height: 12mm
Mazda 3, 6 2014 - On; CX-3,
MX-5 Miata 2016 - On; CX-5 2010 - On

UNIT PACKAGE: 25



25257

(Mazda: KD53-50-M38)
Green Nylon

Pillar Retainer with Sealer
Top Head Diameter: 7mm
Bottom Head Diameter: 10mm
Stem Diameter: 5.8mm
Stem Length: 15mm
Fits into 6mm Hole
Mazda 3, 6, CX-5 2015 - On, CX-3,
CX-9 2016 - On, CX-30 2020 - On

UNIT PACKAGE: 25



20932

(G18K-51-SJ3)
White Nylon

Door Trim Panel Retainer with Sealer
Top Head Diameter: 14mm
Bottom Head Diameter: 18mm
Stem Diameter: 12mm
Stem Length: 14mm
3, 5, 6, CX-7 Miata &
Protégé 2001 - On

UNIT PACKAGE: 10



22512

(Mazda: KD53-51-W24)
Gray Nylon

Wheel Arch Moulding Retainer
Top Head Diameter: 14mm
Bottom Head Diameter: 18.5mm
Stem Diameter: 11mm
Stem Length: 14mm
Mazda CX-3, CX-5
& CX-9 2013 - On

UNIT PACKAGE: 25



21678

(NE51-51-SJ3A)
Black Nylon

Moulding Retainer with Sealer
Top Head Diameter: 14mm
Bottom Head Diameter: 18.5mm
Stem Diameter: 12mm
Stem Length: 14mm
CX-9 & Miata 2006 - On

UNIT PACKAGE: 10



22510

(Mazda: KD51-51-W24)
White Nylon

Wheel Opening Moulding Retainer with Sealer
Top Head Diameter: 15mm
Bottom Head Diameter: 18.5mm
Stem Diameter: 10.8mm
Stem Length: 14mm
Mazda CX-5 2014 - 2013

UNIT PACKAGE: 15



20983

(GJ6R-68-ABX)
White Nylon

Trim Panel Retainer with Sealer
Top Head Diameter: 13mm
Middle Head Diameter: 16mm
Bottom Head Diameter: 18mm
Stem Diameter: 9mm
Stem Length: 13mm
3, 5, 6, Miata &
RX-8 2003 - On

UNIT PACKAGE: 15



14269

(Mazda: 9927-40-825;
Isuzu: 8942264920;
Toyota: 67771-01010, 67771-12010)
White Nylon

Door Panel Retainer
Top Head Diameter: 13mm
Middle Head Diameter: 15.5mm
Bottom Head Diameter: 18mm
Stem Diameter: 9.5mm
Stem Length: 14mm
Overall Length: 20.5mm

UNIT PACKAGE: 25



22484

(Mazda & Ford: E120-68-AB1;
Mitsubishi: MR975267)
Yellow Nylon

Pillar, Scuff Plate & Trim Panel Retainer

Top Head Diameter: 13mm
Middle Head Diameter: 16.5mm
Bottom Head Diameter: 18mm
Stem Diameter: 9.3mm
Stem Length: 13mm
Overall Length: 20mm
Mazda 2 & 3 2015 - 2013
Mitsubishi Montero 1999 - On
Ford Escape (European Version) 2006 - 2000

UNIT PACKAGE: 25



18824

(G350-68-AB1)
White Nylon

Trim Panel Retainer
Top Head Diameter: 13mm
Middle Head Diameter: 16mm
Bottom Head Diameter: 15mm
Stem Length: 9.5mm
Fits into 9mm Hole
626, MX6, Millenia, MX3, 929,
Protege & MPV and
Ford Probe 1992-On

UNIT PACKAGE: 50



22712
 (Mazda: KD45-68-865)
 Green Nylon
Liftgate, Interior Trim & Headliner Retainer
 Top Head Diameter: 13mm
 Middle Head Diameter: 16mm
 Bottom Head Diameter: 18mm
 Stem Diameter: 11mm
 Stem Length: 11mm
 Fits into 8mm Hole
 Mazda 3, CX-3, CX-5 & CX-9 2013 - On

UNIT PACKAGE: 25



21412
 (TD12-51-SJ3A)
 Gray Nylon
Rocker Moulding Retainer with Sealer
 Top Head Diameter: 14mm
 Bottom Head Diameter: 18.5mm
 Stem Diameter: 12mm
 Stem Length: 13mm
 6 GT 2010 - On

UNIT PACKAGE: 15



14363
 (9927-40-821)
 Nylon
Door Panel Retainer
 Top Head Diameter: 15mm
 Bottom Head Diameter: 17mm
 Stem Diameter: 10mm
 Stem Length: 14mm
 Overall Length: 20mm
 Fits into 8mm Hole

UNIT PACKAGE: 25



16778
 (Mazda: 9927-40-822;
 Toyota: 62581-14020)
 Natural Nylon
Trim Panel Retainer
 Top Head Diameter: 14mm
 Bottom Head Diameter: 18mm
 Stem Length: 14mm
 Stem Diameter: 11.5mm
 Overall Length: 20mm

UNIT PACKAGE: 25



19481
 (GA2A-58-762)
 Blue Nylon
Weatherstrip Retainer
 Head Size: 5mm x 15mm
 Stem Length: 8mm
 Fits into 6mm Hole
 626 & Millenia 1995 - On

UNIT PACKAGE: 50



21663
 (EA01-50-037)
 Black Nylon
Push-Type Retainer
 Head Diameter: 10mm
 Stem Length: 9mm
 Fits into 5mm Hole
 2, 3, CX7, CX9, MX-3,
 MX-5 Miata & RX8 1992 - On

UNIT PACKAGE: 15



21662
 (S51S-51-833)
 Black Nylon
Push-Type Retainer
 Head Diameter: 11mm
 Stem Length: 11mm
 Fits into 7mm Hole
 3, MX-5 Miata & RX8 2004 - On

UNIT PACKAGE: 15



14697
 (Mazda: N304-13-356-A;
 GM: 94198687;
 Honda: 90657-SA6-0030)
 Black Nylon

Push-Type Retainer
 Head Diameter: 14mm
 Stem Length: 11mm
 Fits into 7mm Hole

UNIT PACKAGE: 25



17478
 (B101-68-252-00)
 Black Nylon
Interior Trim Push-Type Retainer
 Head Diameter: 14mm
 Stem Length: 16mm
 Fits into 6mm Hole
 Ford Probe and Mazda MX6 1988 - On

UNIT PACKAGE: 25



20923
 (Ford: 3M8Z-1502316-A;
 Mazda: GJ6E-50-715A)
 Black Nylon
Cowl Vent Push-Type Retainer
 Head Size: 8.5mm x 12mm
 Stem Length: 9mm
 Fits into 5mm Hole
 Ford Fusion, Milan & Zephyr 2006 - On
 Mazda 5 & 6 2003 - On

UNIT PACKAGE: 15



14260

(Mazda: 9926-50-625;
Toyota: 90467-06017)
Black Nylon

Push-Type Retainer
Head Diameter: 15mm
Stem Length: 12mm
Fits into 7mm Hole

UNIT PACKAGE: 15



19747

(UB39-50-795)
Black Nylon

Stone Guard Push-Type Retainer
Head Diameter: 18mm
Stem Length: 10mm
Fits into 8mm Hole
MPV 1998-On

UNIT PACKAGE: 10



19306

(GA5R-56-392)
Black Nylon

Shroud Seal Board Push-Type Retainer
Head Diameter: 16mm
Stem Length: 12mm
Fits into 6mm Hole
626 1994-On

UNIT PACKAGE: 10



17632

(Mazda: B092-51-833;
Ford: MB-455-56143, W705845-S300;
Hyundai: 86590-28000)
Black Nylon

Push-Type Retainer
Head Diameter: 18mm
Stem Length: 12mm
Fits into 8mm Hole
Mazda, Hyundai & Ford Aspire

UNIT PACKAGE: 10

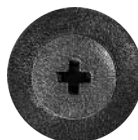

20465

(UB39-45-919)
Black Nylon

Front & Rear Fender Push-Type Retainer
Head Diameter: 18mm
Stem Length: 9mm
Fits into 8mm Hole
626 2000 - On

UNIT PACKAGE: 10



18206

(GJ21-68885B-69)
Gray Nylon

Push-Type Retainer
Head Diameter: 18mm
Stem Length: 12mm
Fits into 6mm Hole
Ford Probe & Mazda MX6 1989-On

UNIT PACKAGE: 25



21024

(Ford: 5R3Z-54310D12-AAA,
6E5Z-7850980-AAA;
Mazda: GJ21-68-885B-02)
Black Nylon

Trim Panel Push-Type Retainer
Head Diameter: 18mm
Stem Length: 10mm
Fits into 6mm Hole
Ford Fusion & Mustang 2005 - On
Mazda 1992 - On

UNIT PACKAGE: 15



2110

(B100-68-8550)
Black Nylon

**Rear Light Access Door
Push-Type Retainer**
Head Diameter: 18mm
Stem Length: 12mm
Fits into 8.5mm Hole
323 1986 - On

UNIT PACKAGE: 15



21858

(B467-68-AC3-02)
Black Nylon

Rear Trunk Liner Push-Type Retainer
Head Diameter: 18mm
Stem Length: 14mm
Fits into 6mm Hole
5, CX-7, CX-9, Miata, Millenia,
MX-6, RX-7 & Protégé 1993 - On

UNIT PACKAGE: 25



19416

(Toyota: 90467-09139)
Black Nylon

**Bumper Cover & Wheel Housing
Push-Type Retainer**
Head Diameter: 18mm
Stem Length: 12mm Excluding Pin
Fits into 9mm Hole
Honda, Mazda 626 &
Toyota Corolla 1992-On

UNIT PACKAGE: 15





22049
(B27K-51-PS7)
Black Nylon

Headlight Bracket Push-Type Retainer
Head Diameter: 18mm
Stem Length: 20mm
Fits into 9mm Hole
Mazda 3, CX-7, CX-9, Miata, MPV & RX-8
2000 - On

UNIT PACKAGE: 15



20755
(GD7A-50-EA1)
Black Nylon

Bumper Cover & Grille Push-Type Retainer
Head Diameter: 19.5mm
Stem Length: 15mm
Fits into 10mm Hole
Mazda 1999 - On

UNIT PACKAGE: 10



14369
(1395-68-676, 9926-50-635)
Black Nylon

Push-Type Retainer
Head Diameter: 20mm
Stem Length: 9mm
Fits into 6mm Hole

UNIT PACKAGE: 15



16000
(Honda: 90675-SB3-003;
Mazda: FB01-56-964;
Nissan: 63876-95596)
Black Nylon

Push-Type Retainer
Head Diameter: 20mm
Stem Length: 9mm
Fits into 8mm Hole

UNIT PACKAGE: 25



19315
(BC1D-56-145)
Black Nylon

Mud Guard Push-Type Retainer
Head Diameter: 20mm
Stem Length: 9mm (Excluding the Pin)
Fits into 8mm Hole
Protege 1996-On

UNIT PACKAGE: 15



21192
(Nissan: 01553-05323, 01553-05933,
01553-10721; Mazda: L33X13209)
Black Nylon

Cowl, Bumper, Fender Liner & Radiator Grille Push-Type Retainer
Head Diameter: 20mm
Stem Length: 12mm
Fits into 8mm Hole

Infiniti FX35, FX45, G35 and Nissan 2003 - On, ,
Frontier 2019 - 2005, Versa Note 2017, NV200 2013 - On;
Mazda 2, 3, 5, 6, CX-5, CX-7 & CX-9 2007 - On

UNIT PACKAGE: 10



22424

(Mazda: B45A-56-146A;
Toyota: 90118-WB048)
Black Nylon

Bumper, Engine Cover, Fender & Quarter Panel Push-Type Retainer

Head Diameter: 20mm
Stem Length: 13mm
Fits into 8mm Hole
Mazda 3, 5, 6, CX-3, CX-5, CX-9 &
MX-5 Miata 2012 - On
Scion iA 2016 - On

UNIT PACKAGE: 25



22515

(Mazda: BGV4-56-145)
Black Nylon

Bumper Cover & Fender Liner Push-Type Retainer

Head Diameter: 20mm
Stem Length: 14mm
Fits into 8mm Hole
Mazda 2, 3, 6, CX-9 &
Miata 2010 - On

UNIT PACKAGE: 25



16858

(Mazda: NA01-56-145;
Kia: MNA01-56-145;
Nissan: 63844-01A00;
Ford: MNA01-56145, NA01-56145)
Black Nylon

Inner Fender Push-Type Retainer

Head Diameter: 20mm (25/32")
Stem Length: 18mm (23/32")
Fits into 8mm (5/16") Hole
Mazda, Kia, Ford & Nissan

UNIT PACKAGE: 25





21119

(B100-68-675-69)
Black Nylon

Push-Type Retainer
Head Diameter: 20mm
Stem Length: 19mm
Fits into 6mm Hole

Mazda MX6 and Ford Probe 1988 - On

UNIT PACKAGE: 15



22282

(FD01-68-AC3)
Gray Nylon

Bumper Filler & Door Panel Push-Type Retainer

Head Diameter: 22mm
Stem Length: 25mm
Fits into 8mm Hole

Mazda 2, 3, 5, 6, CX-5, CX-7 & CX-9 2004 - On

UNIT PACKAGE: 15



16843

(Mazda: BF82-50-233;
Nissan: 01553-01393)
Black Nylon

Bumper Cover Retainer

Head Size: 20mm x 30mm
Stem Length: 18mm
Fits into 10mm Hole

UNIT PACKAGE: 10



17060

(Ford: E92Z-17C756C;
Mazda: GJ21-50-034)
Black Nylon

Bumper Cover Retainer

Head Size: 20mm x 30mm
Stem Length: 20mm
Fits into 10mm Hole
Ford Probe & Mazda MX6 1989-On

UNIT PACKAGE: 10



25073

(Mazda: L206-56-652A)
Black Nylon

Hood Prop Rod Clip

Holds 8mm Prop Rod
Head Size: 16mm x 16mm
Stem Length: 10.5mm
Overall Height: 26mm
Fits into 9mm x 12mm Slot
Mazda 3 2014 - On; 6 2009 - On; CX-3, CX-9 2016 - On; CX-5 2013 - On; CX-7 2012 - 2007

UNIT PACKAGE: 25



22483

(Mazda: S47P-64-345;
Mitsubishi: MQ907568)
White Nylon

Instrument & Side Panel Clip

Width (Ear to Ear): 10.3mm
Overall Height: 18.6mm
Mazda 2, 3, 5, 6, CX-5, CX-7, CX-9, Miata, MPV, Protégé & RX-8 and Mitsubishi 2000 - On

UNIT PACKAGE: 25



23818

(90467-12020, H200-S0-715
BF67-S0715)
Gray Nylon

Grille & Headlamp Door Clip

Toyota Corolla 1983 - On
Chevrolet Nova 1986 - On
Mazda 323 1986 - On
Ford Festiva & Tracer 1988 - On

UNIT PACKAGE: 25



22516

(Mazda: D001-56-731)
Black Nylon

Hood Release Cable Clip

Holds 5mm Diameter Cable
Stem Length: 9mm
Fits into 6mm Hole
Mazda 2, 3, 5, 6, 323, 626, CX-5, CX-7, CX-9, Miata, Millenia, MPV, MX-3, MX-6, Protégé, RX-7 & RX-8 2013 - 1989

UNIT PACKAGE: 25



14359

(9927-80-405)
Nylon

Rod End Clip

Holds 4mm Rods
Snaps into 6mm Hole

UNIT PACKAGE: 25



14365

(9927-80-404)
Nylon

Rod End Clip

Holds 4mm Rods
Snaps into 6mm Hole

UNIT PACKAGE: 25



14376

(9928-90-753)
Nylon

Photo not actual size
Releasable Cable Strap

Length: 110mm (4-3/8")
Max. Bundle Diameter: 25mm
Fits into 7mm Hole

UNIT PACKAGE: 15

14298

(Mazda: 9928-91-053;
Honda: 90672-SA0-003)
Nylon



Photo not actual size
Releasable Cable Strap
Overall Length: 140mm (5-1/2")
Max. Bundle Diameter: 30mm
Fits into 7mm Hole

UNIT PACKAGE: 25

20380

(Not Supplied by O.E.M.)
Black Nylon



Photo not actual size
Cable Strap
Width: 5mm (3/16")
Length: 200mm (8")
Max. Bundle Diameter: 44mm (1-3/4")
Fits into 6.3mm (1/4") Hole
Import Cars

UNIT PACKAGE: 25

17003

(Mazda: GJ21-50-049;
Ford: F32Z-17C756-S)



Bumper Cover Retainer
Front & Rear Bumpers
Mazda & Ford 1988 - On

UNIT PACKAGE: 50

21862

(B455-56-135)
Gray Nylon



Nylon U-Nut
Screw Size: M4.8 (#10)
Panel Range: Up to 1mm
Center of Hole to Edge: 11mm
2, 3, 5, 6, 323, 626, 929, CX-7, CX-9, Miata,
Millenia, MPV, MX-3, MX-5, Protégé,
RX-7 & RX-8 2014 - 1992

UNIT PACKAGE: 25

22519

(Mazda: C274-50-133)
Gray Nylon

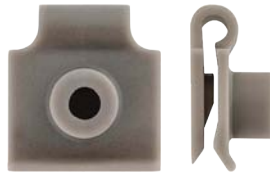

Front Bumper Retainer Nut
Screw Size: M4.8 (#10)
Center of Hole to Edge: 11mm
Panel Range: Up to 1mm
Mazda 2, 5, 6, CX-5, CX-7 &
CX-9 2014 - 2010

UNIT PACKAGE: 25

24522

(90467-04009)
Natural Nylon



U-Nut
Overall Length: 30mm
Overall Width: 18mm
Toyota

UNIT PACKAGE: 10

24523

Same as 24522 except for unit package quantity

UNIT PACKAGE: 25

14750

(Toyota: 53879-14010-A,
53879-14020, 53879-22030;
GM: 94841226;
Mazda: LA01-56-135)
Black Nylon



Nylon U-Nut Fender/Wheel
Housing Applications

Screw Size: #10
Width: 20mm
Length: 31mm
Panel Range: Up to 1mm
Center of Hole to Edge: 11mm
Toyota, Geo Prizm & Nova and Mazda

UNIT PACKAGE: 15

19669

Same as 14750 except for unit package quantity

UNIT PACKAGE: 25

25411

(Mazda: GS1E-56-496A)
Zinc



Under Cover U-Nut
Screw Size: M6-1.0
Panel Range: 4mm
Center of Hole To Edge: 15mm
Width: 16mm
Length: 24mm

Mazda 3 2020 - 2011, 5 2013 - 2012, 6 2020 - 2014, CX-3,
CX-9 2020 - 2016, CX-30 2020, 5 2016 - 2013

UNIT PACKAGE: 25

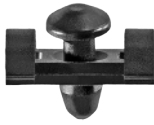

20657

(004-988-76-78, 004-988-77-78)
Black Nylon

Moulding Clip
Width: 11mm
Length: 20mm

UNIT PACKAGE: 15



20897

(002-988-51-81)
Black Nylon

Grille Moulding Clip
Fits into 7mm Hole
CLK320, CLK500 & ML350 2003 - On

UNIT PACKAGE: 10



22902

(Mercedes: 000-991-90-98)
Green Nylon

Liftgate Interior Trim Moulding Clip
Top Head Size: 13mm x 14mm
Bottom Head Size: 15mm x 21mm
Stem Diameter: 8mm x 10mm
Stem Length: 13mm
Fits into 6mm x 10mm Slot
Mercedes-Benz E 350 2016 - 2011
E 450 2019 - On
AMG® E 63 2018 - 2014

UNIT PACKAGE: 25



25336

(Mercedes: 001-991-34-71)
White Nylon

Rocker Moulding Clip
Width: 28mm
Length: 43mm
Overall Height: 27mm

Mercedes S550 2017-2014, S600 2017-2015,
S63 AMG 2020-2014, S450, S560, S65 AMG 2020-2018

UNIT PACKAGE: 15



25039

(Mercedes 000-991-44-71)
White Nylon

Rocker Moulding Clip with Sealer
Width: 16mm
Length: 21mm

Overall Height: 17mm
Stem Length: 9mm
Fits into 9mm Hole
Mercedes-Benz C250 2014 - 2012; C300,
C350 & C63 AMG 2014 - 2008

UNIT PACKAGE: 25



25034

(Mercedes 205-991-00-71)
White Nylon

Rocker Moulding Clip
Width: 20mm
Length: 43mm
Overall Height: 23mm

Mercedes-Benz C300 & C63 AMG 2015 - On;
C350e 2018 - 2016; C400 2015; C43 AMG 2017 - On;
C450 AMG 2016

UNIT PACKAGE: 25



25037

(Mercedes 001-991-02-71)
White Nylon

Rocker Moulding Clip
Width: 28mm
Length: 43mm
Overall Height: 29mm

Mercedes-Benz CLS400 & CLS63 AMG 2018 - 2014;
CLS550 2018 - 2012; E250 2016 - 2014;
E350, E63 AMG 2016 - 2010;
E400 2016 - 2013; E550 2014 - 2010

UNIT PACKAGE: 15

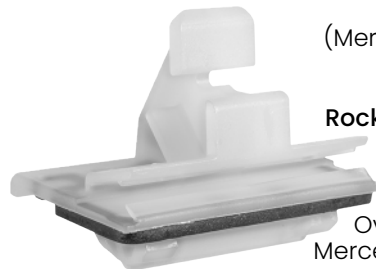

25116

(Mercedes: 000-991-43-71)
Natural Nylon

Rocker Moulding Clip with Sealer
Width: 29mm
Length: 43mm
Overall Height: 33mm

Mercedes C250, C300, C350,
C63 AMG 2014 - 2008

UNIT PACKAGE: 15

25344

(Mercedes: 211-988-05-78)
White Nylon



Rocker Moulding Clip with Sealer

Width: 22mm
Length: 41mm

Stem Size: 8.5mm x 11mm
Stem Length: 9mm
Fits into 9mm Hole

Mercedes CLS500, CLS55 AMG 2006, CLS550, CLS63 AMG 2011-2007, E320, E350 2009-2003, E55 AMG 2006-2003, E550, E63 AMG 2009-2007, S350, S63 AMG 2013-2012, S400 2013-2010, S550, S600 2013-2007, S65 AMG 2012-2007

UNIT PACKAGE: 25

25082

(Mercedes: 012-988-50-78)
Black Nylon with Gray Seal



Moulding Clip

Width: 20mm
Length: 30mm

Stem Diameter: 10mm
Stem Length: 12mm
Fits into 9.5mm Hole

UNIT PACKAGE: 25

22949

(Mercedes: 209-690-00-18)
White Nylon



Drip Rail Clip

Head Size: 8mm x 22mm
Stem Length: 12mm
Overall Length: 16mm

Mercedes-Benz CLK 320, CLK 55 AMG & CLK 500 2006 - 2003, CLK 350, CLK 550 2009 - 2006, CLK 63 AMG 2018

UNIT PACKAGE: 25

25030

(Mercedes: 009-997-36-81)
Gray Nylon



Rocker Moulding Grommet

Head Diameter: 30mm
Stem Length: 12mm
Fits into 20mm Hole

Mercedes-Benz SL500 2006 - 2003; SL55 AMG 2008 - 2003; SL550 2008 - 2007; SL600 2008 - 2004; SL65 AMG 2008 -2005

UNIT PACKAGE: 25

25060

(Mercedes: 001-991-03-71)
White Nylon



Rocker Panel Moulding Clip

Width: 16mm
Length: 18mm

Stem Size: 8.5mm x 11mm
Stem Length: 7.5mm
Overall Height: 20mm
Fits into 9mm Hole

Mercedes CLA250, CLA45 AMG 2019 - 2014; E250 2016 - 2014; E350 2016 - 2010; E400 2016 - 2013; E550 2014 - 2010; E63 AMG 2016 - 2010; S450 2019 - 2018; S550 2017 - 2014; S560 2019 - 2018; S600 2017 - 2015; S63 AMG 2019 - 2014, S65 AMG 2019 - 2018

UNIT PACKAGE: 25

25061

(Mercedes: 001-991-77-71)
White Nylon



Rocker Panel Moulding Clip

Width: 16mm
Length: 18mm

Stem Size: 8.5mm x 11mm
Overall Length: 16.7mm
Fits into 9mm Hole

Mercedes C300 2015 - On; C350 2018 - 2016; C400 2015; C43 AMG 2017 - On; C450 AMG 2016; C63 AMG 2015 - On; E300 2019 - 2017; E400 2018 - 2017; E43 AMG 2018 - 2017; E450, E53 AMG 2019; E63 AMG 2019 - 2018

UNIT PACKAGE: 25

22922

(Mercedes: 000-991-72-98)
White Nylon



Rocker Moulding Clip with Sealer

Top Head Dia.: 24mm
Bottom Head Dia.: 32mm
Stem Dia.: 23mm

Stem Length: 16mm
Fits into 20mm Hole

Overall Height: 39mm
Use with Auveco 22254

Mercedes-Benz A 220, B 250 e, C 250, C 300, C 350, C 63, CLA 250, CLA 45, CLS 400, CLS 550, CLS 63, CLS 63 S, E 250, E 350, E 400, E 550, E 63, E 63 S, GLA 250 & GLA 45 2010 - On

UNIT PACKAGE: 15



20205
(001-988-76-81)
White Nylon

Moulding Insert
Head Diameter: 11.5mm
Stem Length: 12mm
Fits into 9mm Hole

Body Styles 170, 202, 203, 208, 210 & 220 1994 - On

UNIT PACKAGE: 25



25040
(Mercedes: 002-998-17-01)
White Nylon

Emblem Grommet
Head Diameter: 7mm
Stem Length: 4mm
Fits into 5.5mm Hole

Mercedes-Benz C300 & C63 AMG 2015 - On;
C350e 2018 - 2016; C400 2015; C43 AMG 2017 - On;
C450 AMG 2016; E350 2014; E400, S550, S63 AMG, S65
AMG 2017 - 2015; E550 2017 - 2014; GLC300, GLC350e,
GLC43 AMG, GLC63 AMG 2019 - 2017;
GLK250 & GLK350 2015

UNIT PACKAGE: 50



20659
(201-997-22-81)
White Nylon

Hood & Trunk Moulding Insert
Head Diameter: 7mm
Stem Length: 6mm
Fits into 5.5mm Hole
C, CL, CLK, E, SLK & S Class 1996 - On

UNIT PACKAGE: 15



13141
(000-988-15-81)
Red Nylon

Moulding Insert

UNIT PACKAGE: 50



21499
(BMW: 51-44-7-780-135;
Mercedes-Benz: 108-988-00-27)
Natural Nylon

Tubular Nut
Stud Size: 7mm
Head Diameter: 16mm
Stem Length: 16mm
Fits into 8.5mm Hole
BMW, Mercedes-Benz & Universal

UNIT PACKAGE: 25



20647
(000-988-16-25)
White Nylon

Cowl Vent Nylon Nut
Screw Size: M3.5 (#6)
Head Size: 9.5mm x 9.5mm
Stem Length: 14mm
Fits into 6.5mm x 7mm Hole

UNIT PACKAGE: 25



23228
(63171-367-868, 000-988-16-25)
Nylon

**Cowl Vent, Fender Apron
& Door Panel Grommet**
Screw Size: M3.5 (#6)
Head Size: 9.5mm x 9.5mm
Stem Length: 14mm
Fits into 7.2mm Hole
BMW 3, 5, 7, Z3, M 1992 - 2002
Mercedes CL and S Class 2000 - On

UNIT PACKAGE: 50



25427
(Mercedes: 000-998-36-85)
Black Nylon



**License Plate Bracket Screw Grommet
with Sealer**
Screw Size: M4.2 (#8)
Head Diameter: 16mm
Stem Length: 15mm
Overall Height: 19mm
Fits into 8mm Square Hole
Mercedes B 250e 2017 - 2016,
B Electric Drive 2015, GLA 250, GLA 45 AMG 2020 - 2015,
GLB 250 2021 - 2013, GLK 350 2015 - 2010

UNIT PACKAGE: 25



22951
(Mercedes: 003-994-75-45)
Black Nylon



**Bumper, Spoiler & License Mount
Screw Grommet**
Screw Size: M4.2 (#8)
Head Size: 14mm
Stem Length: 8mm
Mercedes-Benz A 220, CLA 250 &
CLA 45 AMG 2019 - On;
CLK 320, CLK 500 & CLK 55 AMG 2005 - 2003;
CLK 350, CLK 550 & CLK 63 AMG 2009 - 2006;
E 350 & E 550 2013 - 2010; GLA 250 2017 - 2015;
GLA 45 AMG 2015 - On; S 63 AMG 2016 - 2014;
SLC 300 & SLC 43 AMG 2017 - On

UNIT PACKAGE: 50



22254
(000-991-74-98)
Black Nylon

Rocker Moulding Retaining Clip
Slotted Head Diameter: 31mm
Stem Diameter: 7mm
Stem Length: 12mm

Mercedes-Benz C, Cla, Cls, E, Gla & S Class 2015 - On

UNIT PACKAGE: 15



22310
(001-988-97-81)
White Nylon

Scuff Plate Retainer
Head Size: 9.5mm x 16.5mm
Stem Length: 13.5mm
Overall Length: 14.5mm
Mercedes-Benz C230, C280, C350, C55, CLK350, CLK500, CLK55, CLK63, S350 & S430 2009 - 2006

UNIT PACKAGE: 25



22504
(Mercedes: 009-988-03-78)
White Nylon
Lower Weatherstrip Retaining Clip
Top Head Size: 12mm x 15mm
Grommet Head Diameter: 11.3mm
Grommet Stem Length: 13mm
Overall Length: 21mm
Mercedes-Benz SLK 230 & SLK 320 2004 - 2001

UNIT PACKAGE: 25



25059
(Mercedes: 000-991-47-95)
Black Nylon

Trunk Side Trim Clip
Head Diameter: 20mm
Stem Diameter: 8mm
Stem Length: 13mm
Overall Height: 14.5mm
Fits into 8mm Hole

Mercedes A220 2019 - On;
C250 2015 - 2012; C300 2010 - On;
C350 2018 - 2010; C400 2015; C43 AMG 2017 - On;
C450 AMG 2016; C63 AMG 2010 - On; CLA250, CLA45 AMG 2014 - On; CLS400 2018 - 2015; CLS450, CLS 53 AMG 2019 - On; CLS550, CLS63 AMG 2018 - 2012; E250 2016 - 2014; E300 2019 - 2017;
E350 2016 - 2010; E400 2018 - 2013;
E43 AMG 2018 - 2017; E450, E53 AMG 2019;
E550 2017 - 2010; E63 AMG 2019 - 2010;
SL400 2016 - 2015; SL450 2019 - 2017;
SL550 2019 - 2013; SL63 AMG 2019 - 2013; SL65 AMG 2018 - 2013; SLC300, SLC43 AMG 2019 - 2017; SLK250 2015 - 2012; SLK300 2016; SLK350, SLK55 AMG 2016 - 2012

UNIT PACKAGE: 25



21105
(001-988-03-25)
Black Nylon

Hood Insulation Retainer
Head Diameter: 20mm
Stem Diameter: 14mm
Stem Length: 10mm
Mercedes - Benz 2002 - On

UNIT PACKAGE: 15



20188
(003-988-41-78)
White Nylon

Trim Panel Retainer
Top Head Diameter: 13mm
Bottom Head Diameter: 18mm
Stem Diameter: 8.5mm
Stem Length: 11mm
Body Styles 107, 108, 109, 114, 115, 123 & 124 1995 - 68

UNIT PACKAGE: 10



20735
(463-988-02-78)
Black Nylon

Door Panel Retainer
Top Head Diameter: 11.5mm
Bottom Head Diameter: 18mm
Stem Diameter: 9mm
Stem Length: 14mm
G55 & G500 2002 - On

UNIT PACKAGE: 25



20642
(000-990-57-92)
Gray Nylon

Door Panel Retaining Clip
Top Head Diameter: 13mm
Bottom Head Diameter: 16mm
Stem Diameter: 9mm
Stem Length: 13mm

UNIT PACKAGE: 10



25032
(Mercedes: 000-991-89-98)
Pink Nylon

Liftgate Trim Cover Retainer
Top Head Diameter: 13mm
Bottom Head Diameter: 17mm
Stem Diameter: 9mm
Stem Length: 14mm
Fits into 8mm Hole
Mercedes-Benz C300, C43 AMG 2017 - On; C63 AMG & E400 2019 - 2017; E350 2016 - 2011; E450, E53 AMG 2019; E63 AMG 2018 - 2014

UNIT PACKAGE: 25



25215

(Mercedes: 000-991-86-98)
Orange Nylon

Door Trim Panel Retainer with Sealer

Top Head Diameter: 13.3mm
Middle Head Diameter: 13.3mm
Bottom Head Diameter: 17mm
Stem Diameter: 9.3mm
Stem Length: 13mm

Mercedes A220, GT53 AMG, GT63 AMG, Sprinter 1500, 2500, 3500 2019 - On, A35 AMG, CLA35 AMG, GLB250 2020 - On, B250e, S600 2017 - 2015, C250, ML350, ML63 AMG, SLK250 2015 - 2012, C300, GLA250, GLA45 AMG, S65 AMG 2020 - 2015; C350 2018 - 2012, C400, ML250, ML400 2015, C43 AMG, GLC43 AMG, SL450, SLC300, SLC43 AMG 2020 - 2017, C450 AMG, GLE450 AMG, SLK300 2016, C63 AMG 2020 - 2012, CLA250 2014 - On, CLA45 AMG 2014 - On, CLS450, CLS53, AMG 2020 - 2019, E250 2016 - 2014, E300, GLE43 AMG, GLS450, GLS550, GLS63 AMG 2019 - 2017, E350, E63 AMG 2020 - 2010, E400, SL65 AMG 2018- 2013, E43 AMG 2018 - 2017, E450, E53 AMG 2020 - 2019, E550, GLK350 2017 - 2010, GL350, GL450, GL550, GL63 AMG 2016 - 2013, GLC300, GLE400, GLE63 AMG 2019 - 2016, GLC350e 2019 - 2018, GLC63 AMG, S450, S560 2020 - 2018, GLE300d 2017 - 2016, GLE350, GLE550e 2018 - 2016, GLK250 2015 - 2013, Metris 2020 - 2016, ML550 2014 - 2012, S550 2017 - 2014, S63AMG 2020 - 2014, SL400 2016 - 2015, SL550 2020 - 2013, SL63 AMG 2019 - 2013, SLK350, SLK55 AMG 2016 - 2012

UNIT PACKAGE: 25



22948

(Mercedes: 001-991-41-98)
Green Nylon

Interior Trunk Trim Panel Retainer with Sealer

Top Head Diameter: 13mm
Middle Head Diameter: 13mm
Bottom Head Diameter: 17mm
Stem Diameter: 9.3mm
Stem Length: 8.5mm
Overall Height: 14mm

Mercedes-Benz C 300, C 43 AMG & C 63 AMG 2017 - On
E 400 2018; E 450 & E53 AMG 2019

UNIT PACKAGE: 25



22252

(000-991-63-98;
000-991-63-98-M22)
Yellow Nylon

Door Garnish Moulding Retainer with Sealer

Top Head Diameter: 13mm
Bottom Head Diameter: 18mm
Stem Diameter: 10.5mm
Stem Length: 12mm

Mercedes-Benz GL450, GL550, MI320, MI550, R63, R320, R350 & R500 2010 - 2006

UNIT PACKAGE: 15



22236

(006-988-43-78)
White Nylon

Tailgate Garnish Retainer with Sealer

Top Head Diameter: 13mm
Bottom Head Diameter: 18mm
Stem Diameter: 9.3mm
Stem Length: 13mm

Mercedes-Benz C Class, CLK Class, E Class, SL Class & SLK Class 1996 - On

UNIT PACKAGE: 25



22905

(Mercedes: 000-997-01-33)
Black Nylon

Cowl & Liftgate Moulding Trim Retainer with Sealer

Top Head Dia.: 13mm
Bottom Head Dia.: 16mm
Stem Diameter: 9.3mm
Stem Length: 14mm

Mercedes-Benz B 250e, C 300, C 350e, C 400, AMG C 43, AMG 450, AMG C 63, E 300, AMG 63, GL 350, GL 450, GL 550, AMG GL 63, GLA 250, AMG GLA 45, GLE 300d, GLE 350, GLE 400, AMG GLE 43, GLE 550e, AMG GLE 63, ML 250, ML 350, ML 400, ML 550, AMG ML 63, S 550, S 560 & AMG S 65 2012 - On

UNIT PACKAGE: 25



22899

(Mercedes: 000-991-24-98)
White Nylon

Upper Quarter Trim Retainer

Top Head Diameter: 13mm
Bottom Head Diameter: 19mm
Stem Diameter: 11.5mm
Stem Length: 19mm

Mercedes-Benz E 250, E 350, E 400 & E 550 2016 - 2010 AMG* E 63 2015 - 2010

UNIT PACKAGE: 25



20879

(007-988-99-78, 007-988-34-78)
Green Nylon

Door Trim Panel Retainer

Top Head Diameter: 13mm
Bottom Head Diameter: 17mm
Stem Diameter: 9mm
Stem Length: 14mm

Mercedes-Benz 1996 - On

UNIT PACKAGE: 10



22305

(001-991-26-98)
Yellow Nylon

Door Trim Panel Retainer with Sealer

Top Head Diameter: 13.3mm
Middle Head Diameter: 13.3mm
Bottom Head Diameter: 17mm
Stem Diameter: 9.3mm
Stem Length: 13mm

Mercedes-Benz CLS400, CLS550, CLS63, S500, S600 & S63 2012 - On

UNIT PACKAGE: 15



22309
(000-991-01-98; 011-988-76-78)
White Nylon

Door Upper Pillar Trim & Trunk Lining Retainer with Sealer

Top Head Diameter: 13.3mm
Middle Head Diameter: 13.3mm
Bottom Head Diameter: 17mm
Stem Diameter: 9.3mm
Stem Length: 13mm

Mercedes-Benz C250, C300, C350, C63, GLA250, GLA45, GLK250 & GLK350 2013 - On

UNIT PACKAGE: 15



20253
(BMW: 51-41-1-973-500,
Mercedes: 000-991-71-71)
White Nylon

Trim Panel Retainer

Top Head Diameter: 14mm
Middle Head Diameter: 15mm
Bottom Head Diameter: 18mm
Stem Diameter: 9mm
Stem Length: 15mm

BMW Series 3, 5 & 7 1987 - On;
Mercedes Metris 2020 - 2016; Sprinter 1500, 2500, 3500 2010 - On

UNIT PACKAGE: 50



13230
(Mercedes 000-990-03-92;
Volvo: 947-098)
Black Nylon

Push-Type Retainer

Head Diameter: 10mm
Stem Length: 7mm
Fits into 5mm Hole

UNIT PACKAGE: 50



20187
(Mercedes: 000-990-34-92;
BMW: 51-16-1-881-149;
VW: N-102-593-01)
Black Nylon

Radiator Housing Push-Type Retainer

Head Diameter: 10mm
Stem Length: 10mm
Fits into 6mm Hole
Body Styles 116, 123, 124, 126, 129, 140, 170, 201, 208 & 210 1974 - On
BMW & VW

UNIT PACKAGE: 15



21037
(000-990-84-92)
Black Nylon

Push-Type Retainer

Head Diameter: 10mm
Stem Length: 10mm
Fits into 6mm Hole
Mercedes - Benz 2005 - On

UNIT PACKAGE: 25



21711
(000-991-59-40)
Black Nylon & Santoprene Rubber

Push-Type Retainer

Head Diameter: 11mm
Stem Length: 16mm
Fits into 6mm Hole
CLS55, CLS500, C Class, E Class & S1k Class 2006 - On

UNIT PACKAGE: 15



20314
(000-990-37-92)
Black Nylon

Trunk Trim & General Purpose Push-Type Retainer

Head Diameter: 13mm
Stem Length: 14mm
Fits into 8mm Hole
SL500 & SL600 Convertible 1999 - On

UNIT PACKAGE: 15



20640
(000-990-40-92, 124-990-05-92-9051)
Black Nylon

Push-Type Retainer

Head Diameter: 12mm
Stem Length: 11mm
Fits into 5mm Hole

UNIT PACKAGE: 25



20639
(000-990-44-92)
Black Nylon

Push-Type Retainer

Head Diameter: 12mm
Stem Length: 11mm
Fits into 5mm x 5mm Hole

UNIT PACKAGE: 25



20234
(BMW: 51-11-1-908-077;
Mercedes: 000-990-54-92)
Black Nylon

Bumper, Grille, Scuff Plate & Trim Push-Type Retainer

Head Diameter: 15mm
Stem Length: 15mm
Fits into 6.3mm Hole
Mercedes-Benz 2014 - 1994
BMW Series 3, 5 & 7 1984 - On

UNIT PACKAGE: 50



22710
(BMW: 51-48-1-884-779)
Black Nylon

Radiator Cover, Sound Insulation & Trunk Trim Push-Type Retainer

Head Diameter: 19.5mm
Stem Length: 15mm
Fits into 7mm Hole

BMW 3 & 5 Series, M3 and M5 1991 - 1982
UNIT PACKAGE: 25



21044
(123-990-05-92, 126-990-03-92)
Black Nylon
Cowl Screen Cover Push-Type Retainer
Head Diameter: 16mm
Stem Length: 11mm
Fits into 6.3mm Hole
E, CL & S Class 2000 - On
UNIT PACKAGE: 15



20636
(123-990-00-92)
Dark Gray Nylon
Push-Type Retainer
Head Diameter: 12mm
Stem Length: 10mm
Fits into 8.5mm Hole
UNIT PACKAGE: 15



25335
(Mercedes: 000-991-92-40)
Black Nylon
Trim Panel Push-Type Retainer
Head Diameter: 15mm
Stem Length: 11.5mm
Stem Diameter: 5mm
Fits into 5mm Hole
Panel Range: 3mm-5mm
Mercedes AMG GT, S580 2021, C230 2007 - 2003, C32 AMG 2004 - 2002, C55 AMG 2006 - 2005, C240, C320 2005 - 2001, C280, C350 2007 - 2006, CLK350 2009 - 2006, CLK500 2006 - 2004, CLK550 2009 - 2007, CLK63 AMG 2008, CLK320, CLK55 AMG 2005 - 2004, GLC300, Metris 2021 - 2016, GLC350, S450, S560, S65 AMG 2020 - 2018, GLC43 AMG 021 - 2017, GLC63 AMG 2021 - 2018, S500 2021- 2014, S600 2017 - 2015, S63 AMG 2020 - 2014, SL400 2016 - 2015, SL450, SLC300, SLC43 AMG 2020 - 2017, SL550 2020 - 2013, SL63 AMG 2019 - 2013, SL65 AMG 2018 - 2013, SLK280 2008 - 2006, SLK300 2011 - 2009, SLK350 2011 - 2005, SLK55 AMG 2010 - 2005, Sprinter 1500, 2500, 3500 2021 - 2019
UNIT PACKAGE: 25



20909
(124-990-04-92)
Black Nylon
Push-Type Retainer
Head Diameter: 16mm
Stem Length: 18mm
Fits into 7mm Hole
Mercedes-Benz 2003 - On
UNIT PACKAGE: 15



22901
(Mercedes: 000-991-41-40)
Black Nylon
Rear Fender Liner Push-Type Retainer
Head Diameter: 20mm
Stem Length: 19mm
Fits into 7mm Hole
Mercedes-Benz A 220, C 300, C 350e, C 400, AMG* C 43, AMG* C 450, AMG* C 63, E 300, AMG* E 63, S 550, S 550e, S 560, S 600, AMG* S 63 & AMG* S 65 2015 - On
UNIT PACKAGE: 25



14992
(Ford: N803946S;
Chry: 6502871;
Mercedes: 000-991-52-40)
Black Nylon
Door Panel Push-Type Retainer
Head Diameter: 19/32"
Stem Length: 29/32"
Fits into 1/4" Hole
Ford & Chrysler 1987 - On;
Mercedes Metris 2020 - 2016; Sprinter 1500, 2500, 3500 2019 - On

UNIT PACKAGE: 50



20637
(123-990-02-92)
Black Nylon
Push-Type Retainer
Head Diameter: 20mm
Stem Length: 9mm
Fits into 8.5mm Hole

UNIT PACKAGE: 10



22306
(000-991-49-40-M58)
Black Nylon
Lower Engine Cover, Interior Trim & Trunk Cover Liner Push-Type Retainer
Head Diameter: 20mm
Stem Length: 10mm
Fits into 8mm Hole
Mercedes-Benz C300, C400, C63, CLS400, CLS550, CLS63, GLK250, GLK350, S550, S63 & S65 2015 - On

UNIT PACKAGE: 15



21086
(Mercedes-Benz: 230-990-01-92;
Chry: 6104900-A)
Black Nylon
Hood Insulation & Cowl Grille Push-Type Retainer
Head Diameter: 20mm
Stem Length: 10mm
Fits into 8mm Hole
Mercedes GL, M, R, SL & SLK 2005 - On
Chrysler 2010 - On

UNIT PACKAGE: 15



22950
(Mercedes: 001-991-57-98)
Purple Nylon
Door Trim Panel Retainer with Sealer
Top Head Diameter: 13mm
Middle Head Diameter: 13mm
Bottom Head Diameter: 13mm
Stem Diameter: 9.4mm
Stem Length: 14mm
Overall Height: 20mm
Mercedes-Benz B 250 e 2017 - 2016;
B Electric Drive 2015

UNIT PACKAGE: 25



20638

(BMW: 51471911992,
51470146782, 51470390017)
Mercedes-Benz: 201-990-02-92)
Black Nylon

Push-Type Retainer

Head Diameter: 20mm
Stem Length: 14mm
Fits into 8.5mm Hole
BMW 1, 2, 3, 4, 5, 6, 7, i3, i8, X
& Z Series 1988 - On
Mercedes-Benz

UNIT PACKAGE: 25



25216

(Mercedes: 000-991-39-40)
Black Nylon

Interior Trim Panel Push-Type Retainer

Head Diameter: 20mm
Stem Length: 14mm
Fits into 8.5mm Hole
Mercedes G550, G63 AMG 2019 - On
Metris 2020 - 2016 Sprinter 1500, 2500, 3500 2010 -On

UNIT PACKAGE: 25



25214

(Mercedes: 230-990-00-92-9C75)
Dark Gray Nylon

Interior Trim Push-Type Retainer

Head Diameter: 20mm
Stem Length: 21mm
Fits into 8.5mm Hole
Mercedes A220, CLS 450, CLS53 AMG, G550, G63 AMG,
Sprinter 1500 2019 - On, B250e 2017 - 2015,
C230 2007 - 2003, C240, C320 2005 - 2001, C280,
ML500 2007 - 2006, C300, C63 AMG 2009 - 2008,
C32 AMG 2004 - 2002, C350, CLK350 2009 - 2006,
C55 AMG 2006 - 2005, CL550, C600 2014 - 2007, CL63,
CL65 AMG 2014 - 2008, CLA250, CLA45 AMG 2014 - On,
CLK320 2005 - 2003, CLK500, CLK55 AMG, E500, E55
AMG 2006 - 2003, CLK550, GL320 2009 - 2007,
CLK63 AMG 2008 - 2007, E300, GLC300, GLS450, GLS550,
GLS63 AMG, SL450, SLC300, SLC43 AMG 2019 - 2017,
E320 2009 - 2003, E350 2016 - 2006, E400 2018 - 2015,
E43 AMG 2018 - 2017, E450, E53 AMG,
GLC43 AMG, GLE43 AMG 2019, E550, S550,
S600 2017 - 2007, E63 AMG, S65 AMG 2019 - 2007,
GL350 2016 - 2010, GL450 2016 - 2007,
GL550 2016 - 2008, GL63 AMG 2016 - 2013, GLA250,
GLA45 AMG 2015 - On, GLC63 AMG, S450,
S560 2019 - 2018, GLE300d 2017 - 2016, GLE350, GLE550e
2018 - 2016, GLE400, GLE63 AMG,
Metris 2019 - 2016, GLE450 AMG 2016,
GLS350d 2017, ML320 2009 - 2007,
ML350 2011 - 2006, ML450 2011 - 2010,
ML550 2011 - 2008, ML63 AMG 2011 - 2007,
S350 2013 - 2012; S400 2013 - 2010,
S63 AMG 2019 - 2008, SL400 2016 - 2015, SL550,
SL63 AMG 2019 - 2013; SL65 AMG 2018 - 2013,
SLK250 2015 - 2012, SLK280 2008 - 2006,
SLK300 2016 - 2009, SLK350,
SLK55 AMG 2016 - 2005, Sprinter 2500, 3500 2010-On

UNIT PACKAGE: 25



25222

(GM: 90450482;
Mercedes: 001-990-16-92-64)
Black Nylon

Mud Guard Push-Type Retainer

Head Diameter: 19mm
Stem Length: 15mm
Fits into 8mm Hole
Buick Regal 2020 - 2018 Mercedes ML320 2003- 1998,
ML350 2005 - 2003, ML430 2001 - 1999,
ML500 2005 - 2002, ML55 AMG 2003 - 2000,
Sprinter 1500, 2500, 3500 2019 - On

UNIT PACKAGE: 25



22339

(001-990-01-92)
Black Nylon

**Rocker Panel Moulding
Push-Type Retainer**

Head Diameter: 30.5mm
T25 Drive
Stem Length: 17mm
Fits into 8.5mm Hole
Mercedes-Benz CLS550, CLS63 AMG,
SL550, SL600, SL63 AMG, SLK300,
SLK350 and SLK55 AMG 2011 - 2008

UNIT PACKAGE: 25



20203

(124-990-07-92)
Black Nylon

Push-Type Retainer

Head Size: 11mm x 14mm
Stem Length: 8mm
Fits into 7mm x 8mm Hole
Body Styles 124, 129, 140, 170, 202, 203, 208,
210, 215, & 220 1986 - On

UNIT PACKAGE: 25



25038

(Mercedes: 002-988-05-42)
Black Nylon

Fender Apron Retainer

Head Diameter: 18mm
Stem Length: 15mm
Stem Size: 5.5mm x 12mm
Mercedes-Benz C250 & GLK250 2015 - 2012;
C300 2014 - 2008; C350, C63 AMG 2015 - 2008;
CLA250, CLA45 AMG 2014 - On; E250 2016 - 2014;
E350 2014 - 2010; E400 2017 - 2015; E550 2017 - 2010;
GLK300d 2016; ML250 2015; SL400 2016 - 2015;
SL450 2019 - 2017; SL550, SL63 AMG &
SL65 AMG 2019 - 2013

UNIT PACKAGE: 25



25058

(Mercedes: 000-991-21-95)
Black Nylon

Radiator Upper Insulator Push-Type Retainer

Head Diameter: 30mm
Flange Size: 23mm x 40mm
Stem Diameter: 11mm
Stem Length: 22mm
Fits into 11mm Hole

Mercedes C300 2008 - On;
C43 AMG 2017 - On;

C250 2015 - 2012; C350 2018 - 2008;
C400 2015; C450 AMG 2016; C63
AMG 2008 - On; CL550, CL600 2014 - 2007;
CL63 AMG, CL65 AMG 2014 - 2008;
CLS400 2016 - On; CLS53 AMG 2019 - On;
CLS55 AMG 2006; CLS550 2018 - 2007;
CLS63 AMG 2018 - 2007; E250 2016 - 2014;
E300 2019 - 2017; E320 2009 - 2007;
E350 2016 - 2007; E400 2018 - 2013;
E43 AMG 2018 - 2017; E450 2019; E53 AMG 2019;
E550 2017 - 2007; E63 AMG 2019 - 2007;
GLC300 2019 - 2016; GLC350e 2019 - 2019; GLC43 AMG
2019 - 2017; GLC63 AMG 2019 - 2018; GLK250 2015 - 2013;
GLK 350 2015 - 2010; S350 2013 - 2012;
S400 2013 - 2010; S550, S600 2013 - 2007; S63
AMG 2013 -2008; S65 AMG 2013 - 2007

UNIT PACKAGE: 10



25081

(Mercedes: 002-998-16-50)
Black Rubber

Trunk Lid Hole Plug

Head Size: 10mm
Stem Length: 6mm
Overall Height: 8mm
Fits into 7mm Hole

Mercedes-Benz A220, CLS450, CLS53 AMG 2019 -On,
C300, C63 AMG 2015 - On, C43 AMG 2017 - On, CLA220,
CLA45 AMG 2020 - On, E300 2019 - 2017, E450,
E53 AMG 2019, E63 AMG 2019 - 2018,
C350 2018 - 2016, E400 2018 - 2017, C450 AMG 2016

UNIT PACKAGE: 50



22921

(Mercedes: 003-998-13-50)
Black Nylon

Trunk & Door Hole Plug

Head Diameter: 22mm
Fits into 16mm Hole

Mercedes-Benz A 220, CLA 250, CLA 45,
E 400, E 450, E 53, S 550, S 560,
S 63 & S 65 2017 - On

UNIT PACKAGE: 25



20645

(201-990-00-50)
Black Nylon

Rear Compartment Carpet Retainer

Stud Size: 5mm
Head Diameter: 24mm
Hex: 10mm

UNIT PACKAGE: 25



21431

(BMW: 16-13-1-176-747;
Mercedes-Benz: 003-990-02-51)
Black Nylon

Nylon Flange Nut

Stud Size: 5mm
Flange Diameter: 16mm
Hex: 10mm
Overall Height: 11mm
BMW & Mercedes-Benz 1997 - On

UNIT PACKAGE: 25



22780

(BMW: 07-14-7-169-847,
07-14-7-166-870;
Mercedes: 002-990-53-50)
Black Nylon

Fender Liner, Wheel Apron & Rocker Moulding Nut

Screw Size: M4.8-1.61 (#10)
Hex Size: 10mm
Flange Diameter: 22mm
BMW 230i, 320i, 328d, 330e, 330i, 330i GT, 340i, 340i GT,
430i, 430i Gran Coupe, 440i, 440i Gran Coupe &
M2 2018 - On; Mini-Cooper, Clubman,
Countryman & Paceman 2011 - On
Mercedes CL550, CL600 2014 - 2007;
CL63 AMG, CL65 AMG 2014 - 2008;
G550, G63 AMG, Sprinter 1500, 2500,
3500 2019 - On; S350 2013 - 2012;
S400 2013 - 2010; S550, S600 2013 - 2007;
S63 AMG, S65 AMG 2013 - 2008

UNIT PACKAGE: 25



25080

(Mercedes: 000-990-31-62)
Black Nylon

Fender Liner & Apron and Under Cover Hex Flange Nut

Thread Size: M4.8-1.61
Flange O.D.: 30mm
Hex Size: 10mm
Height: 11.5mm
Mercedes-Benz E400 2017 - 2015,
E550 2017 - 2010,
C250 2015 - 2012, C350,
C63 AMG 2015 - 2008,
C300 2014 - 2008, E350,
E550 2014 - 2010

UNIT PACKAGE: 25



20654

(001-997-42-90)
Black Nylon



Photo not actual size
Cable Strap
Length: 120mm (4-3/4")
Fits into 8mm Hole

UNIT PACKAGE: 10

21305

(Not Available from O.E.M.)
Natural Nylon

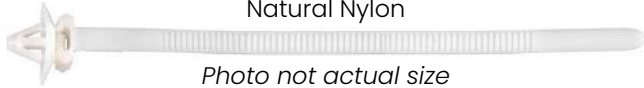

Photo not actual size
Push-Mount Cable Strap
Strap Width: 5mm (3/16")
Length: 156mm (6-1/8")
Snaps into 6.3mm (1/4") Hole
Maximum Bundle Diameter: 40mm (1-9/16")
European Makes & Universal

UNIT PACKAGE: 25

20655

(114-997-02-90)
Black Nylon



Photo not actual size
Cable Strap
Length: 160mm (6-3/8")
Fits into 8mm Hole

UNIT PACKAGE: 10

22115

(124-988-90-78-M89)
Zinc



Bumper Moulding Clip
Width: 16mm
Length: 19mm
Overall Height: 9mm
Mercedes

UNIT PACKAGE: 25

20649

Screw Size: M3.5 (#6)
Panel Range: .5mm - 1.5mm
Center of Hole to Edge: 8mm



UNIT PACKAGE: 50

13223

(BMW: 0712-9-925-708;
Mercedes: 000-994-25-45)
Plated



U-Type Nut
Screw Size: 4.2mm (#8)
Panel Range: 3mm-4mm
Center of Hole to Edge: 7mm

UNIT PACKAGE: 50

WARNING: Reproductive Harm & Cancer
www.P65Warnings.ca.gov

13224

(000-994-04-45)
Plated



U-Type Nut
Screw Size: 4.2mm (#8)
Panel Range: .5mm-1.7mm
Center of Hole to Edge: 8mm

UNIT PACKAGE: 50

WARNING: Reproductive Harm & Cancer
www.P65Warnings.ca.gov

25035

(Smart/Mercedes: 001-991-39-70)
Yellow Nylon



U-Nut

Screw Size: M4.2 (#8)
Width: 18mm
Length: 35mm
Panel Range: 3mm
Center of Hole to Edge: 15mm
Smart Car Fortwo 2015 - 2008

UNIT PACKAGE: 25

13218

(BMW: 0712-9-925-737;
Mercedes: 000-994-06-45)
Plated



U-Type Nut

Screw Size: 4.8mm
Panel Range: .5mm-1.7mm
Center of Hole to Edge: 7mm

UNIT PACKAGE: 50

13215

(Mercedes: 000-994-14-45)
Plated



U-Type Nut

Screw Size: 4.8mm
Panel Range: .8mm-1.7mm
Center of Hole to Edge: 11mm
Mercedes & BMW

UNIT PACKAGE: 50

13216

Zinc



U-Type Nut

Screw Size: 4.8mm
Panel Range: .9mm-2.0mm
Center of Hole to Edge: 8mm

UNIT PACKAGE: 25

13220

(Mercedes: 000-994-09-45;
Volvo: 946-418; Opel: 20-72-175)
Plated



U-Type Nut

Screw Size: 6.3mm
Panel Range: .7mm-1.5mm
Center of Hole to Edge: 13mm

UNIT PACKAGE: 50

WARNING: Reproductive Harm & Cancer
www.P65Warnings.ca.gov

25057

(Mercedes: 000-990-32-62)
Black Nylon

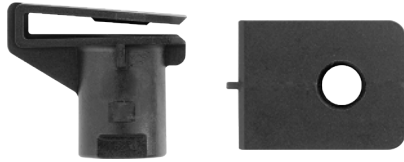

Bumper Pipe Shield Extension U-Nut

Screw Size: M6

Width: 17mm

Length: 23.7mm

Panel Range: 3mm Max.

Center of Hole to Edge: 12mm

Mercedes CLS400 2018 - 2015;

CLS550, CLS63 AMG 2018 - 2012; E250, E350 2016 - 2014;

E400 2017 - 2014; E550 2017 - 2010; E63 AMG 2016 - 2014;

GL350, GL460, GL 550 2012 - 2010; GLC300 2019 - 2016;

GLC350e 2019 - 2018; GLC43 AMG 2019 - 2017;

GLC63 AMG 2019 - 2018; GLE43 AMG 2019 - 2017;

GLE450 AMG 2016; GLE63 AMG 2019 - 2016;

GLK250, GLK350 2015 - 2013

UNIT PACKAGE: 25

22952

(BMW & Mini Cooper:
07-14-7-265-039)
Natural Nylon



Door & Quarter Panel Screw Grommet with Sealer

Screw Size: M5

Head Size: 23mm

Stem Length: 19mm

BMW 740e, 740i, 745e, 750i, M760i & Z4 2016 - On;
i3 2018 - 2014; Mini Cooper 2014 - On

UNIT PACKAGE: 25

MINI-COOPER CLIPS & FASTENERS

21659

(07-13-2-757-821)
Gray Nylon



Moulding Clip

Top Head Size: 11mm x 19mm

Bottom Head Diameter: 21mm

Stem Length: 11mm

Mini-Cooper 2002 - On

UNIT PACKAGE: 15

25402

(Mini: 51-13-7-034-022)
White Nylon



Wheel Opening Moulding Clip

Outside Diameter: 20mm

Overall Height: 7.5mm

Fits onto M4.8-1.61 Stud

Mini Cooper 2008 - 2002

UNIT PACKAGE: 25

21527

(07-13-7-073-915)
White Nylon



Trim Panel & Fender Flare Moulding Clip

Top Head Size: 11.5mm x 19mm

Bottom Head Diameter: 21mm

Stem Length: 13mm

Fits into 8mm Hole

Mini Cooper S 2002 - On

UNIT PACKAGE: 15

21143

(51-71-1-496-621)
Black Nylon



Rocker Moulding Retainer

Head Size: 8.5mm x 14mm

Stem Size: 5mm x 7.5mm

Stem Length: 14mm

Mini Cooper 2002 - On

UNIT PACKAGE: 25

21709

(07-13-1-480-419)
Black Nylon



Rocker Panel Moulding Clip

Top Head Size: 16mm x 20mm

Middle Head Diameter: 18mm

Bottom Head Diameter: 23mm

Stem Length: 19mm

Mini-Cooper 2002 - On

UNIT PACKAGE: 15

22858

(BMW: 51-12-7-461-407)
Brown Nylon



Bumper Support Screw Grommet with Sealer

Screw Size: M4.8 or M5

Head Diameter: 11mm

Stem Length: 16mm

Overall Height: 21mm

Fits into 8mm x 8mm Hole

BMW X1 & X2 2017 - On

Mini-Cooper Countryman 2017 - On

UNIT PACKAGE: 25



21137

(07-13-0-702-516)
Black Nylon

Rear Quarter Wheel Opening Moulding Retaining Clip

Top Head Diameter: 13mm
Middle Head Diameter: 15mm
Bottom Head Diameter: 15mm
Stem Diameter: 10mm
Stem Length: 8mm
Fits into 8mm Hole
Mini Cooper 2002 - On

UNIT PACKAGE: 25



21787

(BMW: 51-77-7-171-002)
White Nylon

Wheel Arch Cover & Footboard Retainer with Sealer

Top Head Diameter: 12mm
Bottom Head Diameter: 18mm
Stem Diameter: 9.5mm
Stem Length: 16mm
Mini-Cooper S & SX Series 2011 - On
BMW X Series 2006 - On

UNIT PACKAGE: 25



21138

(51-43-7-001-491-2)
White Nylon

Headliner Retainer

Top Head Diameter: 14mm
Middle Head Diameter: 15mm
Bottom Head Diameter: 18mm
Stem Diameter: 9mm
Stem Length: 14mm
Mini Cooper 2005 - On

UNIT PACKAGE: 25



21788

(BMW: 51-41-8-224-768, 51-41-0-407-984)
White Nylon

Door Panel Lining & Rear Window Retainer with Sealer

Top Head Diameter: 14mm
Middle Head Diameter: 15.5mm
Bottom Head Diameter: 18mm
Stem Diameter: 9.5mm
Stem Length: 14mm
Overall Length: 20.5mm
Mini-Cooper 2002 - On
BMW X Series 2006 - On

UNIT PACKAGE: 25



22285

(07-14-6-962-771)
Red Nylon

Rocker Moulding & Pillar Retainer with Sealer

Top Head Diameter: 14.3mm
Middle Head Diameter: 15.5mm
Bottom Head Diameter: 18mm
Stem Diameter: 9.5mm
Stem Length: 13mm
Overall Length: 19mm
Mini-Cooper 2006 - On

UNIT PACKAGE: 15



22303

(BMW: 51-16-8-197-908)
Black Nylon

Upper Cover & Spoiler Push-Type Retainer

Head Diameter: 12mm
Stem Length: 13mm
Fits into 7mm Hole

BMW 1, 3, M3 & Z4 and Mini-Cooper Base, John Cooper Works, Countryman & Paceman 2013 - On

UNIT PACKAGE: 15



22855

(BMW: 51-49-8-237-075)
Dark Gray Nylon

Trunk Lid, Quarter Trim & Control Module Push-Type Retainer

Head Diameter: 15.5mm
Stem Length: 13mm
Fits into 8mm Hole
BMW 128i, 135i, 323i, 325Ci, 325i, 325xi, 328i, 328xi, 330Ci, 330i, 330xi, 335d, 335i, 335is, 335xi, M3, X3, & X4 2018 - 1999
Mini-Cooper 2007 - On

UNIT PACKAGE: 25



22859

(BMW: 16-13-6-753-087)
Black Nylon

Cowl Grille & Fuel Tank Strap Push-Type Retainer

Head Diameter: 15mm
Stem Length: 8mm
Fits into 6.3mm Hole
BMW 320i, 328d, 328i, 328i GT, 330e, 330i, 330i GT, 335i, 335i GT, 340i, 340i GT, 428i, 428i Gran Coupe, 430i, 430i Gran Coupe, 435i, 440i & 440i Gran Coupe 2012 - On
Mini-Cooper 2015 - 2007

UNIT PACKAGE: 25



20570

(Mini-Cooper: 07-13-0-702-715;
Honda: 75307-SN7-000)

Wheel Opening Nylon Moulding Nut With Brass Insert

Thread: M4-0.7
Flange Outer Diameter: 12mm
Hex: 10mm
Height: 11mm

UNIT PACKAGE: 15



21305

(Not Available from O.E.M.)
Natural Nylon

Photo not actual size
Push-Mount Cable Strap

Length: 156mm (6-1/8")
Strap Width: 5mm (3/16")
Snaps into 6.3mm (1/4") Hole
Maximum Bundle Diameter: 40mm (1-9/16")
European Makes & Universal

UNIT PACKAGE: 25

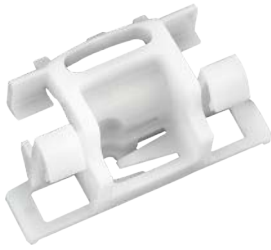

19314
(MB814419)
Nylon

**Drip Moulding & Garnish
Moulding Clip**
Galant 1993-On

UNIT PACKAGE: 25



17195
Black Nylon

Grille Clip
Width: 13mm
Length: 22mm
Ford Escort, Honda, Isuzu,
Mitsubishi & Plymouth Laser

UNIT PACKAGE: 25



21623
(Mitsubishi: MR221507;
Toyota: 90467-13075)
Gray Nylon

Radiator Grille Clip
Width: 14mm
Length: 24mm

Mitsubishi Diamante, Endeavor & Galant 1997 - On
Toyota 4 Runner, Highlander & Land Cruiser 1998 - On

UNIT PACKAGE: 25



19330
(MB608140)
White Nylon

**Trunk Air Dam
Side Moulding Clip**
Diamante 1991-On

UNIT PACKAGE: 10



21863
(Hyundai: 87758-35010)
White Nylon

Moulding Clip with Sealer
Top Head Size: 10mm x 12mm
Bottom Head Size: 14mm x 18mm
Stem Length: 10mm
Hyundai Accent, Kia Soul &
Mitsubishi Outlander 2006 - On

UNIT PACKAGE: 15



14255
(Mitsubishi: MS-480001;
Honda: 75522-611-000;
Mazda: 9991-00-412)
Black Nylon

Screw Size: #8
Width: 9.5mm
Length: 9.5mm
Snaps into 7mm x 7mm Hole

UNIT PACKAGE: 50



13932
(Mitsubishi: MS-480002;
Toyota: 90189-05013)
Natural Nylon

Screw Size: #10
Width: 12mm
Length: 12mm
Fits into 8mm x 9mm Hole

UNIT PACKAGE: 50



19485
Natural Nylon

Screw Size: #14 (M6.3)
Fits into 3/8" x 3/8" Hole
Eclipse

UNIT PACKAGE: 10



14335
(Mitsubishi: MB-106212;
Nissan: 96706-H9400, -K1300,-K1351)
Natural Nylon

Screw Grommet
Screw Size: #8
Head Diameter: 13.5mm
Stem Length: 16mm
Fits into 6mm x 6mm Hole

UNIT PACKAGE: 50



14695
(Mitsubishi: MS-480012;
Honda: 90661-SC7-003;
Mazda: H001-50-841;
Nissan: 01651-00481, 74798-S9000;
Toyota: 90189-06042)
White Nylon

Screw Grommet
Screw Size: #8
Head Diameter: 16mm
Stem Length: 17mm
Fits into 8mm x 8mm Hole

UNIT PACKAGE: 25



19322
(MU480034)
Natural Nylon

**Rear Side & Trunk Trim
Screw Grommet**
Screw Size: #8
Eclipse 1994-On

UNIT PACKAGE: 15



14275
(Mitsubishi: MB-098145;
Nissan: 01281-00023, 01281-00231;
Toyota: 90189-06001)
White Nylon

Screw Grommet
Screw Size: #10
Head Diameter: 18mm
Stem Length: 17mm
Fits into 8.5mm x 8.5mm Hole
UNIT PACKAGE: 25



20581
(MR478263)
Black Rubber

Bumper Cover & Garnish Moulding Grommet with Sealer
Head Diameter: 16mm
Stem Length: 20mm
Fits into 9mm Hole
Use with Auveco 20580
Chrysler Sebring & Stratus
and Mitsubishi Eclipse 2000 - On
UNIT PACKAGE: 15



25428
(Mitsubishi: MB361578, MR280579)
White Nylon

Stone Guard & Rocker Moulding Screw Grommet with Sealer
Screw Size: M4.2 (#8)
Head Size: 17mm X 17mm
Stem Length: 21mm
Overall Height: 24mm
Fits into 8mm x 10mm Hole
Mitsubishi Diamante 2004 - 1997,
Eclipse 2012 - 1995,
Eclipse Cross 2020 - 2018,
Endeavor 2007 - 2004, Galant 2012 - 1999,
Lancer 2017 - 2002, Mirage 2021 - 2014,
Montero 2006 - 2002, Outlander 2007 - On
UNIT PACKAGE: 25



19331
(MB869072)
Black Nylon

Headliner & Trunk Trim Retaining Clip
Head Diameter: 14mm
Stem Length: 11mm
Fits into 7mm Hole
Diamante 1995-91
UNIT PACKAGE: 15



20381
(Honda: 90667-671-013ZA;
Mitsubishi: MC440901;
Nissan: 62660-48600-1)
Black Nylon

Trim Panel Retaining Clip
Head Diameter: 16mm
Stem Diameter: 7mm
Stem Length: 16mm
Honda, Mitsubishi & Nissan
UNIT PACKAGE: 25



14720
(HB-121467)
Black Nylon

Retaining Clip
Head Diameter: 18mm
Shank Length: 15mm
Panel Thickness: 5mm
Snaps into 8mm Hole

UNIT PACKAGE: 25



19323
(MU481187)
Black Nylon

Hood Insulation Retainer
Head Diameter: 26mm
Stem Diameter: 10mm
Stem Length: 8mm
Diamante 1993-On

UNIT PACKAGE: 15



22589
(Mitsubishi: MU001282)
Black Nylon

Hood Insulation Retainer
Head Diameter: 26mm
Stem Diameter: 10mm
Stem Length: 10mm
Fits into 9mm Hole
Mitsubishi Diamante, Eclipse, Endeavor, Galant,
Lancer, Mirage, Montero & Outlander 1992 - On

UNIT PACKAGE: 50



22082
(MB655630)
Black Nylon

Hood Insulation Retainer
Head Diameter: 26mm
Stem Length: 14mm
Fits into 9mm Hole
Mitsubishi Diamante & Montero 2004 - 1992

UNIT PACKAGE: 15



22361
(Mitsubishi: MR489986)
Pale Yellow Nylon

Wheel Arch Cover Retainer with Sealer
Top Head Diameter: 12mm
Bottom Head Diameter: 16mm
Stem Diameter: 8mm
Stem Length: 8mm
Mitsubishi Montero 2001 - On
Outlander 2015 - On

UNIT PACKAGE: 15

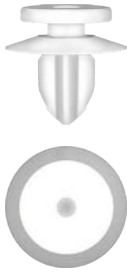

22513

(Mitsubishi: MU000573)
White Nylon

Interior Speaker Grille & Rocker Moulding Retainer
Top Head Diameter: 12mm
Bottom Head Diameter: 16mm
Stem Diameter: 8mm
Stem Length: 10mm
Mitsubishi Galant 2012 - On
Lancer 2016 - 2008

UNIT PACKAGE: 25



21690

(MR322000)
White Nylon

Trim Panel Retainer with Sealer
Top Head Diameter: 12mm
Bottom Head Diameter: 16mm
Stem Diameter: 8mm x 8mm
Stem Length: 14mm
Diamante, Eclipse, Galant,
Montero & Outlander 2000 - On

UNIT PACKAGE: 25



19334

(MB566720)
Natural Nylon

Rear Pillar Trim & Air Inlet Grille Retainer
Top Head Diameter: 12mm
Bottom Head Diameter: 16mm
Stem Diameter: 9mm
Stem Length: 15
Eclipse 1994-On

UNIT PACKAGE: 15



19320

(MB696120)
White Nylon

Side Garnish & Moulding Trim Retainer
Top Head Diameter: 12mm
Bottom Head Diameter: 16mm
Stem Diameter: 9mm
Stem Length: 11mm
Eclipse 1994-On

UNIT PACKAGE: 15



20571

(MR435918)
White Nylon

Rocker Panel Retainer
Top Head Diameter: 13mm
Bottom Head Diameter: 18mm
Stem Diameter: 9mm
Stem Length: 9mm
Montero 2001 - On

UNIT PACKAGE: 15



22484

(Mazda & Ford: E120-68-ABI;
Mitsubishi: MR975267)
Yellow Nylon

Pillar, Scuff Plate & Trim Panel Retainer
Top Head Diameter: 13mm
Middle Head Diameter: 16.5mm
Bottom Head Diameter: 18mm
Stem Diameter: 9.3mm
Stem Length: 13mm
Overall Length: 20mm
Mazda 2 & 3 2015 - 2013
Mitsubishi Montero 1999 - On
Ford Escape (European Version) 2006 - 2000

UNIT PACKAGE: 25



22462

(Mitsubishi: MU000977)
Blue Nylon

Rocker Moulding Retainer
Top Head Diameter: 13mm
Bottom Head Diameter: 18mm
Stem Diameter: 9.8mm
Stem Length: 9mm
Mitsubishi Mirage 2014 - On

UNIT PACKAGE: 25



21118

(MB374270, MB374271)
White Nylon

Trim Panel Retainer
Top Head Diameter: 13mm
Middle Head Diameter: 16mm
Bottom Head Diameter: 18mm
Stem Diameter: 10mm
Stem Length: 14mm
Overall Length: 20.5mm
Chrysler Laser, Dodge Stealth, Jeep Eagle & Talon and
Mitsubishi Eclipse & Montero 1989 - On

UNIT PACKAGE: 15



19325

(MU481027)
Brown Nylon

Hood Weatherstrip Retainer
Head Size: 5mm x 13mm
Stem Diameter: 7mm
Stem Length: 6mm
Eclipse & Diamante 1991-On

UNIT PACKAGE: 25



25347

(Mitsubishi: MR380850)
White Nylon

Door Weatherstrip Clip with Sealer
Head Size: 5mm x 15mm
Stem Length: 10mm
Fits into 6mm Hole
Mitsubishi Outlander 2007, Montero 2000-1994

UNIT PACKAGE: 15



21658

(Mitsubishi: MR288150;
Subaru: 909130013)
Black Nylon

Push-Type Retainer

Head Diameter: 15mm
Stem Length: 11mm
Fits into 6mm Hole

Mitsubishi Endeavor, Galant, Lancer, Mirage,
Montero & Outlander 1997 - On
Subaru BRZ, Forester, Impreza, Legacy,
Outback, & XV Crosstrek 2004 - On

UNIT PACKAGE: 10



21140

(MB619582)
Black Nylon

**Interior Trim, Bumper & Grille
Push-Type Retainer**

Head Diameter: 15mm
Stem Length: 12mm
Fits into 6.3mm Hole

Eclipse, Endeavor, Lancer & Outlander 2002 - On

UNIT PACKAGE: 25



20580

(MR478262)
Black Nylon

**Bumper Cover & Garnish Moulding
Push-Type Retainer**

Top Head Diameter: 15mm
Bottom Head Diameter: 14mm
Stem Length: 12mm
Fits into 7mm Hole

Use with Auveco 20581

Chrysler Sebring & Stratus
and Mitsubishi Eclipse 2000 - On

UNIT PACKAGE: 15



19239

(GM: 11519949;
Honda: 91512-SX0-003;
Mitsubishi: MU000319;
Lexus & Toyota: 90467-08217)
Black Nylon

**Front Fender, Bumper Support, Interior
Trim & Washer Tank Push-Type Retainer**

Head Diameter: 20mm
Stem Length: 11mm
Fits into 8mm Hole

Acura 3.5RL, Honda Accord, Prelude & Odyssey
1994 - On; Mitsubishi Lancer 2002 - On; GM 1997 - On;
Lexus GX470 2009 - 2003; Toyota 4Runner 2009 - 2003,
FJ Cruiser 2014 - 2007, Tacoma 2016 - 2005

UNIT PACKAGE: 25



20247

(MR200300)
Black Nylon

Fender & Bumper Push-Type Retainer

Head Diameter: 18mm
Stem Length: 12mm
Fits into 9mm Hole

Honda & Mitsubishi 1998 - On

UNIT PACKAGE: 15



17351

(MB-253964)
Black Nylon

Front & Rear Bumper Push-Type Retainer

Head Diameter: 17mm
Stem Length: 10mm
Fits into 7mm Hole
Tredia 1988-83



UNIT PACKAGE: 10



25206

(Chrysler & Mitsubishi:
MU001220, MU000695)
Black Nylon

Bumper & Apron Push-Type Retainer

Head Diameter: 20mm
Stem Length: 20mm
Fit into 8mm Hole

Chrysler Sebring, Stratus 2005;
Mitsubishi Eclipse, Galant 2012 - 2006;
Endeavor 2008 - 2006 & 2010 - 2011;
Outlander 2006



UNIT PACKAGE: 25



22077

(MB879499)
Black Nylon

Front Bumper Push-Type Retainer

Head Diameter: 18mm
Stem Length: 9mm
Fits into 9mm Hole

Mitsubishi Montero 2006 - 01

UNIT PACKAGE: 25



17472

(Mitsubishi: MB547806;
Nissan: 63854-01A00)
Black Nylon

Front Bumper Fascia Push-Type Retainer

Head Diameter: 20mm
Stem Length: 20mm
Fits into 8mm Hole

UNIT PACKAGE: 15



19140

(Acura: 90505-SL0-003;
GM: 94852638;
Mitsubishi: MB888869;
Toyota: 90467-08155)
Black Nylon

Push-Type Retainer

Head Diameter: 20mm
Stem Length: 21mm
Fits into 8mm Hole

Acura, Dodge Avenger, Eagle Talon, Geo Prizm,
Mitsubishi Eclipse & Galant and Toyota 1993-On

UNIT PACKAGE: 5



13225

Plated

U-Type Nut

Screw Size: 4.2mm (#8)
Width: 11mm
Length: 16.5mm
Panel Range: .5mm-2.5mm
Center of Hole to Edge: 8mm

UNIT PACKAGE: 50



18951

(MR-138807)
Black Nylon

Front Bumper & Support Push-Type Retainer

Head Diameter: 20mm
Stem Length: 26mm
Fits into 8mm Hole
Eclipse 1994-On

UNIT PACKAGE: 5



20380

(Not Supplied by O.E.M.)
Black Nylon

Photo not actual size

Cable Strap

Width: 5mm (3/16")
Length: 200mm (8")
Max. Bundle Diameter: 44mm (1-3/4")
Fits into 6.3mm (1/4") Hole
Import Cars

UNIT PACKAGE: 25

NISSAN CLIPS & FASTENERS



16860

(62318-01W00)
Dark Gray Nylon

Grille Clip

Overall Height: 21.5mm (27/32")

UNIT PACKAGE: 25



21085

(Not Available from O.E.M.)
Light Blue Nylon

Rocker Panel Moulding Clip

Overall Height: 15mm
Stem Length: 9mm
Murano 2003 - On

UNIT PACKAGE: 15



21121

(01553-03831)
Black Nylon

Grille Clip

Overall Height: 22mm (7/8")
Maxima & Stanza 1982 - On

UNIT PACKAGE: 25



21291

(76988-4N000)
White Nylon

Moulding Clip

Top Head Size: 8mm x 15mm
Bottom Head Diameter: 15mm
Stem Diameter: 5.3mm
Stem Length: 9mm
Quest & 370Z 2004 - On

UNIT PACKAGE: 25



21619

(76882-0M060)
Black Nylon

Grille Clip

Overall Height: 25mm (1")
Frontier, Krom & SL 2006 - On

UNIT PACKAGE: 15



22076

(76882-6P010)
Natural Nylon

Hood, Front Fender Bracket & Exterior Moulding Clip

Top Head Size: 15mm x 15mm
Bottom Head Size: 15mm x 15mm
Stem Length: 15mm
Overall Length: 22mm
Infiniti Q45 2001 - 1996
Nissan Altima & Maxima 2006 - 2002

UNIT PACKAGE: 25



22301

(01553-05233)
Black Nylon

Fender Liner Moulding Clip

Top Width: 31mm
Bottom Width: 30mm
Overall Height: 11mm
Infiniti JX35 & QX60 2013 - On
Nissan Altima, Murano, Pathfinder,
Rogue & Sentra 2007 - On

UNIT PACKAGE: 25



21683
(76882-EW00B)
White Nylon

Rocker Moulding & Exterior Trim Moulding Clip with Sealer
Top Head Size: 6mm x 9mm
Bottom Head Diameter: 13mm
Stem Length: 7mm
Fits into 8mm Hole
Nissan Altima & Juke 2011 - On

UNIT PACKAGE: 10



22061
(76882-JG10A)
White Nylon

Fender Moulding Clip with Sealer
Top Head Size: 6mm x 12mm
Bottom Head Diameter: 16mm
Stem Length: 10mm
Infiniti Qx80 2014 - On
Nissan Juke 2011 - On

UNIT PACKAGE: 25



21285
(76882-EG01A)
Black Nylon

Rocker Panel Moulding Clip with Sealer
Top Head Size: 10mm x 15mm
Bottom Head Diameter: 18mm
Stem Length: 12mm
Fits into 8mm Hole
Altima and Maxima 2010 - On

UNIT PACKAGE: 15



22055
(76847-1JB0A)
White Nylon

Moulding Clip with Sealer
Top Head Diameter: 13mm
Bottom Head Diameter: 13mm
Stem Length: 11mm
Fits into 8mm Hole
Nissan Altima, Quest & Sentra 2011 - On

UNIT PACKAGE: 15



21618
(01553-08911)
White Nylon

Scuff Plate Moulding Clip
Top Head Size: 12mm x 15mm
Bottom Head Diameter: 16mm
Stem Length: 12mm
Fits into 8.5mm Hole
Maxima 1999 - On

UNIT PACKAGE: 15



22574
(Nissan: 73998-3TA0A)
White Nylon

Headliner Retainer
Top Head Size: 19mm x 23mm
Bottom Head Diameter: 17mm
Stem Size: 8mm x 11mm
Stem Length: 9mm
Overall Length: 13mm
Nissan Altima, Maxima, Titan & Titan XD 2013 - On

UNIT PACKAGE: 25



22897
(Nissan: 01553-09131)
Blue Nylon

Quarter Trim Panel Retainer
Top Head Diameter: 13mm
Middle Head Diameter: 16mm
Bottom Head Diameter: 18mm
Stem Diameter: 9mm
Stem Length: 10mm
Infiniti G35, I30, I35 & M45 2007 - 2000
Q50 & Q60 2014 - On
Nissan 200SX & Sentra 1999 - 1995
350Z, Altima & Quest 2008 - 1999
GT-R, Maxima & Xterra 2005 - On

UNIT PACKAGE: 25



22767
(Nissan: 80897-7J100)
Yellow Nylon

Door Insulator Clip
Head Size: 17mm x 20mm
Stem Diameter: 7mm
Stem Length: 19mm
Overall Length: 22mm
Fits into 6mm Hole
Nissan Cube, Juke, Leaf, Murano, NV, Rogue, Rogue Sport, Sentra, Titan, Versa & Versa Note 2007 - On

UNIT PACKAGE: 25



20961
(Not Available from O.E.M.)
White Nylon

Drip Moulding Clip with Sealer
Top Width: 25mm
Overall Height: 16mm
Fits into 5mm Hole
Infiniti M45, I30 & G35 2005 - On
Nissan Altima, Maxima & 350Z 2002 - On

UNIT PACKAGE: 15



20614
(66820-3S510)
White Nylon

Cowl Vent Retainer
Head Size: 10mm x 18mm
Stem Diameter: 6mm
Stem Length: 13mm
Frontier & Xterra 1998 - On

UNIT PACKAGE: 25



22523

(Nissan: 76882-1KA1A)
Green Nylon

Rocker Panel Moulding Clip with Sealer
Top Head Size: 10mm x 17mm
Bottom Head Diameter: 18mm
Stem Length: 12mm
Fits into 8mm Hole
Nissan Juke 2016 - On

UNIT PACKAGE: 25



22476

(Nissan: 66820-4BA5A)
Black Nylon

Cowl Grille Clip
Width: 13mm x 20mm
Overall Height: 20mm
Nissan Rogue 2014 - On

UNIT PACKAGE: 25



22345

(Not Available from O.E.M.)
Black Nylon

Rocker Panel Moulding Clip
Top Head Size: 14mm x 21.5mm
Bottom Head Size: 14mm x 21.5mm
Stem Length: 12mm
Fits into 9mm Hole
Nissan Pathfinder

UNIT PACKAGE: 25



22833

(Nissan: 90990-1KA0B)
Blue Nylon

Liftgate Moulding Clip with Sealer
Top Head Size: 10mm x 15mm
Bottom Head Diameter: 19mm
Stem Length: 10mm
Fits into 6mm Hole
Overall Length: 15mm
Nissan Juke 2011 - On

UNIT PACKAGE: 25



22281

(76847-JG00A)
Yellow Nylon

Wheel Well Opening Moulding Clip
Head Size: 8mm x 17mm
Stem Length: 12mm
Overall Height: 16.5mm
Use with Auveco 22257
Nissan Juke 2011 - On

UNIT PACKAGE: 25



22032

(76988-3DN0A)
Green Nylon

Windshield Garnish Moulding Clip
Overall Length: 44mm
Fits into 7mm x 12mm Hole
Nissan Altima, Juke & Sentra 2011 - On

UNIT PACKAGE: 10



15468

(72826-01P00)
Nylon

Windshield Moulding Clip
Width: 11mm
Length: 40mm
300ZX 1984 - On

UNIT PACKAGE: 15



17349

(79796-71E00)
Nylon

Window Reveal Moulding Clip
Back Glass
Maxima 1990-On

UNIT PACKAGE: 25



21097

(Not Available from O.E.M.)
Black Nylon

Windshield Moulding Clip
Width: 22mm
Length: 46mm
Altima 2004 - On

UNIT PACKAGE: 25



23853

(72796-30P00)
White Nylon

Windshield Moulding Clip
Nissan 300 ZX 1990 - On

UNIT PACKAGE: 15



18113

(69951-12180)
Nylon with

Steel Threaded Insert

Glass Mount
Thread: M6-1.0
Nissan, Ford & Imports

UNIT PACKAGE: 5



21930
(Renault & Dacia: 77-03-081-160;
Nissan: 01281-00QAF)
Natural Nylon

Nylon Nut
Screw Size: M2.9mm (#4)
Head Size: 9mm x 9mm
Stem Length: 7mm
Renault, Dacia & Nissan

UNIT PACKAGE: 50



13930
(Nissan: 96706-B0700;
Mazda: 9991-00-412)
White Nylon

Screw Size: #8
Width: 9.5mm
Length: 9.5mm
Snaps into 7mm x 7mm Hole

UNIT PACKAGE: 50



14274
(Mazda: 9991-00-601;
Honda: 75521-611-000;
Nissan: 96706-P0105;
Toyota: 90189-06010)
Natural Nylon

Screw Size: #10
Width: 13mm
Length: 13mm
Snaps into 8.5mm x 8.5mm Hole

UNIT PACKAGE: 25



14334
(96706-N8000)
Natural Nylon

Screw Size: #8
Width: 12mm
Length: 15mm
Fits into 8mm x 12mm Hole

UNIT PACKAGE: 25



14313
(Nissan: 62698-V7000, 68425-H5000;
Honda: 90662-671-003;
Mazda: 9991-00-503)
Natural Nylon

Screw Size: #10
Width: 17mm
Length: 17mm
Snaps into 8mm x 8.5mm Hole

UNIT PACKAGE: 25



20764
(01281-00831)
Natural Nylon

Bumper, Fender & Light Screw Grommet
Screw Size: M4.2 (#8)
Head Diameter: 16mm
Stem Length: 10mm
Fits into 9mm x 9mm Hole
Nissan 240SX, Altima, Frontier, Maxima, Pathfinder,
Quest & Xterra and Infiniti 1989 - On

UNIT PACKAGE: 25



17342
(01281-00441)
Black Nylon

Front Bumper Apron Nylon Nut
Screw Size: #10
Head Diameter: 15mm
Snaps into 8mm x 8mm Hole
Stanza 1990-On

UNIT PACKAGE: 25



20266
(62319-0W000)
Natural Nylon

Front Bumper Nylon Nut
Screw Size: M5.5 (#12)
Head Diameter: 16mm
Stem Length: 11mm
Frontier Truck 1997 - On

UNIT PACKAGE: 10



22416
(Nissan: 01281-00111)
Natural Nylon

Screw Grommet
Screw Size: M5.5 (#12)
Head Diameter: 16mm
Stem Length: 11mm
Infiniti FX35, FX45, G20, G25, G35, G37, I30,
J30, Q40, Q45, Q60, QX4 & QX56 1997 - On
Nissan 200SX, 240SX, 300ZX, Altima, Armada, Cube,
Frontier, GT-R, Juke, Leaf, Maxima, Murano, Pathfinder,
Quest, Rogue & Sentra 1987 - On

UNIT PACKAGE: 25



22274
(01281-01121)
White Nylon

Screw Grommet with Sealer
Screw Size: 2.9mm (#4)
Head Diameter: 12mm
Stem Length: 16mm
Fits into 7mm x 7mm Square Hole
Infiniti M35h, M45, Q45 & QX50 and Nissan
Altima, Maxima, Pathfinder, Quest, Rogue &
Sentra 2012 - 2003

UNIT PACKAGE: 10



14724

(96706-H2500)
Natural Nylon

Screw Grommet

Screw Size: #6
Head Diameter: 11.5mm
Stem Diameter: 9.5mm
Fits into 7mm x 7mm Hole

UNIT PACKAGE: 25



14366

(Nissan: 96706-89901;
Mazda: 9991-00-402)
Natural Nylon

Screw Grommet

Screw Size: #6
Width: 9.5mm
Length: 9.5mm
Stem Length: 16mm
Fits into 7mm x 7mm Hole

UNIT PACKAGE: 50



21367

(01281-00501)
White Nylon

Body Side Moulding Screw Grommet with Sealer

Screw Size: M3.5 (#6)
Head Size: 9.5mm x 9.5mm
Stem Length: 16mm

UNIT PACKAGE: 15



14335

(Nissan: 96706-H9400; -K1300, -K1351;
Mitsubishi: MB-106212)
Natural Nylon

Screw Grommet

Screw Size: #4
Head Diameter: 13.5mm
Stem Length: 16mm
Fits into 6mm x 6mm Hole

UNIT PACKAGE: 50



14695

(Nissan: 01651-00481 74798-S9000;
Honda: 90661-SC7-003;
Mazda: H001-50-841;
Mitsubishi: MS-480012;
Toyota: 90189-06042)
White Nylon

Screw Grommet

Screw Size: #8
Head Diameter: 16mm
Stem Length: 17mm
Fits into 8mm x 8mm Hole

UNIT PACKAGE: 25



21324

(01281-00691)
Natural Nylon

Screw Grommet with Sealer

Screw Size: 4.2 (#8)
Head Diameter: 16mm
Stem Length: 20mm
Nissan 240SX, Altima, Frontier, Maxima, Pathfinder &
Titan and Infiniti I30, I35 & Q45 1989 - On

UNIT PACKAGE: 15



22239

(Nissan: 76881-5HA0A)
Black Nylon

Screw Grommet

Head Diameter: 16mm
Stem Length: 12mm
Fits into 8mm x 8mm Hole
Use with Auveco 22292
Nissan Armada 2017 - On, Murano &
Rogue 2014 - On, Pathfinder 2021 - On

UNIT PACKAGE: 15



20604

(01281-00711)
Natural Nylon

Rocker Moulding Screw Grommet

Screw Size: M4.2 (#8) & M4.8 (#10)
Head Diameter: 20mm
Stem Length: 15mm
Nissan & Infiniti 1995 - On, NV200 2013 - On

UNIT PACKAGE: 10



14275

(Nissan: 01281-00023, 01281-00231;
Mitsubishi: MB-098145;
Toyota: 90189-06001)
White Nylon

Screw Grommet

Screw Size: #10
Head Diameter: 18mm
Stem Length: 17mm
Fits into 8.5mm x 8.5mm Hole

UNIT PACKAGE: 25



21621

(01553-02913)
White Nylon

Moulding Grommet with Sealer

Screw Size: M4.2 (#8)
Head Diameter: 14mm
Stem Length: 8mm
Fits into 8mm Hole
Nissan Frontier, Pathfinder &
Titan and Infiniti QX4 & QX56 1996 - On

UNIT PACKAGE: 15



19293

(01281-00601)
Natural Nylon

**Body Side Moulding
Floor & Trunk Screw Grommet**
Screw Size: M4.8 (#10)
Maxima, Sentra, 240SX & 300ZX 1986-On

UNIT PACKAGE: 15



22311

(88796-6P000)
Natural Nylon

Screw Grommet with Sealer
Screw Size: M4.8 (#10)
Head Diameter: 16mm
Stem Length: 15mm
Nissan Frontier & Rogue 2005 - On

UNIT PACKAGE: 15



21768

(63846-5V000)
White Nylon

Bumper Grommet with Sealer
Screw Size: M4.8 (#10)
Head Diameter: 20mm
Stem Length: 16mm
Overall Length: 22mm

Infiniti FX35, FX45, JX35, M35, M36, M37, M56 & QX56 and
Nissan Altima, Juke, Maxima, Murano,
Quest & Sentra 2003 - On

UNIT PACKAGE: 25



22494

(Nissan: 01281-01431)
Natural Nylon

Front Bumper Screw Grommet
Screw Size: M5.5 (#12)
Head Diameter: 14mm
Stem Length: 17mm
Overall Length: 20mm
Infiniti Q30 2017 - On
Nissan Altima, Cube, Maxima,
Murano, NV, Quest, Sentra,
Titan & Versa 2009 - On

UNIT PACKAGE: 25



22766

(Nissan: 85099-IEA0A)
Yellow Nylon

Bumper Screw Grommet
Screw Size: M5
Head Diameter: 14mm
Stem Length: 15.5mm
Overall Length: 18.5mm

Infiniti Q50 & QX80 2014 - On, QX56 2013 - 2011
Nissan 370Z 2009 - On, Armada & Quest 2017 - On

UNIT PACKAGE: 25



22123

(85099-1VA0A)
White Nylon

Screw Grommet with Sealer
Screw Size: M5.5 (#12)
Head Diameter: 19mm
Stem Length: 16mm
Overall Length: 20mm
Nissan LEAF, Pathfinder & Rogue 2011 - On

UNIT PACKAGE: 10



22831

(Nissan: 01651-00491)
White Nylon

**Trunk & Liftgate Moulding Screw
Grommet with Sealer**
Screw Size: M6
Head Diameter: 20mm
Stem Length: 17.5mm
Fits into 10mm x 10mm Hole
Nissan 200SX 1998 - 1995
Altima, Juke, Maxima, Murano,
Quest, Rogue, Rogue Sport, Sentra
& Titan 2018 - 2007

UNIT PACKAGE: 25



21824

(26557-2U001)
Brown Nylon

Screw Grommet with Sealer
Screw Size: M6.3-1.81 (#14)
Head Size: 15mm x 19mm
Stem Length: 16mm
Infiniti EX35, G37, JX35, M35, M45, Q50, QX56, QX60 &
QX70 and Nissan 350Z, 370Z, Altima, Armada, Cube,
Juke, Maxima, Murano, Pathfinder, Quest, Rouge,
Sentra, Versa & Xterra 2014 - 02

UNIT PACKAGE: 15



21111

(01281-00331)
Natural Nylon

**Bumper, Rocker Panel & Light Mounting
Screw Grommet with Sealer**
Screw Size: M6.3 (#14)
Head Diameter: 20mm
Stem Length: 16mm
Fits into 10mm Square Hole
Infiniti 1997 - On, Nissan 1996 - On

UNIT PACKAGE: 25



22261

(76848-35F00)
White Nylon

Moulding Screw Grommet with Sealer
Head Diameter: 18mm
Stem Diameter: 8.5mm
Stem Length: 14mm
Infiniti G35, G37, I30, I35, M35h, Q40, Q50,
Q70, QX56 & QX80 and Nissan 350Z, Altima,
Cube, Pathfinder & Sentra 2003 - On

UNIT PACKAGE: 15



22522

(Nissan: 85099-1MA0A)
Yellow Nylon

**Front & Rear Bumper
Screw Grommet**
Screw Size: M5.5 (#12)
Top Head Size: 10mm x 10mm
Bottom Head Size: 15mm x 16mm
Stem Length: 9mm
Nissan Pathfinder, Sentra,
Versa & Versa Note 2012 - On

UNIT PACKAGE: 25



20736

(01281-01081)
Natural Nylon

Front Bumper Nylon Nut
Screw Size: M4.8 (#10)
Flange Diameter: 16mm
Overall Length: 22mm
Nissan & Infiniti 1997 - On

UNIT PACKAGE: 15



14690

(Nissan: 78856-R4301,
Honda: 90683-693-000)
White Nylon

Screw Grommet
Screw Size: #10
Width: 12mm
Length: 19mm
Stem Length: 17mm
Fits into 8mm x 15mm Hole

UNIT PACKAGE: 25



21622

(76848-71S00)
Yellow Nylon

Pillar Moulding Grommet with Sealer
Screw Size: M5.5 (#12)
Head Size: 15.4mm x 19mm
Stem Length: 15mm
Nissan 370Z & Quest and
Infiniti G37 & Q45 2002 - On

UNIT PACKAGE: 15



21688

(01553-02923)
White Nylon

**Moulding, Door Sill Plate
Grommet with Sealer**
Head Size: 14mm x 18mm
Stem Length: 13mm
Infiniti M45 & Q45 and Nissan Armada,
Frontier, Pathfinder & Xterra 1996 - On;
NV200 2013 - On

UNIT PACKAGE: 25



22440

(Nissan: 26557-2U000)
Gray Nylon

**Quarter Panel, Rear Light &
Spoiler Grommet with Sealer**
Screw Size: M6.3-1.81 (#14)
Head Size: 15mm x 19mm
Stem Length: 16mm
Overall Length: 17.5mm
Infiniti FX35, FX50, G37, JX35, M35, M45, Q50, Q60, QX50,
QX60, QX70 & QX80 and Nissan 350Z, Altima, Armada,
Maxima, Murano, Pathfinder, Quest,
Rogue, Sentra & Versa 2003 - On

UNIT PACKAGE: 25



22257

(Nissan: 76848-5HA0A)
Gray Nylon

**Wheel Well Opening &
Fender Flare Screw Grommet**
Screw Size: M6.3-1.81 (#14)
Head Size: 12mm x 16mm
Stem Length: 10mm
Overall Height: 12mm
Use with Auveco 22281
Nissan Armada 2021 - 2017, Juke 2011 - 2017,
Rogue 2014 - 2020

UNIT PACKAGE: 15



22176

(01281-00431)
Natural Nylon

Screw Grommet
Screw Size: M6 (#14)
Head Size: 14mm x 14mm
Overall Height: 19mm
Nissan Murano 2003 - On

UNIT PACKAGE: 25



22059

(76848-54C00)
Black Nylon

**Rear Taillight Assembly & Exterior
Rocker Moulding Grommet with Sealer**
Head Diameter: 18mm
Stem Diameter: 8.5mm
Stem Length: 14mm
Nissan 2003 - On

UNIT PACKAGE: 25



17196

(62380-U7400)
Black Nylon

Grille Grommet
Width: 22mm
Length: 26mm
Nissan 1987 - On

UNIT PACKAGE: 10

NISSAN CLIPS & FASTENERS



22287
(62319-AU000)
Black Nylon

Front Bumper & Grille Screw Grommet
Head Size: 13.5mm x 23.5mm
Stem Length: 13mm
Overall Height: 15mm
Infiniti G37, M35, M45, QX56 &
QX80 and Nissan Rogue 2006 - On

UNIT PACKAGE: 15



22255
(76848-ED000)
Light Blue Nylon

Rocker & Door Trim Panel Grommet
Head Diameter: 15mm
Stem Diameter: 8mm
Stem Length: 15mm
Infiniti Q60 Coupe and Nissan 350Z &
Versa 2014 - 2006

UNIT PACKAGE: 25



20790
(85222-0M000)
Black Nylon

Rear Bumper Fascia Clip with Sealer
Overall Height: 35mm
Stem Length: 16mm
Pathfinder 2004 - On

UNIT PACKAGE: 5



22763
(Nissan: 85284-JD00A)
Gray Nylon

Bumper Cover Clip
Width: 20mm
Length: 32mm
Overall Height: 20mm
Nissan Rogue Sport
2017 - On

UNIT PACKAGE: 20



22452
(Nissan: 85284-AL510)
Gray Nylon

Rear Bumper Cover Moulding Clip
Width: 20mm
Length: 32mm
Overall Height: 20.5mm
Infiniti G35, FX35 &
FX45 2008 - 2003
Nissan Pathfinder 2012 - 2005

UNIT PACKAGE: 5



22218
(85284-EG000)
Yellow Nylon

Rear Bumper Clip
Width: 20mm
Length: 32mm
Overall Height: 25mm
Nissan GT-R and Infiniti G,
Q40, FX & QX70 2009 - On

UNIT PACKAGE: 15



20813
(63846-9E000)
Natural Nylon

Rear Bumper Moulding Grommet with Sealer
Head Size: 18mm x 18mm
Stem Length: 15mm
Altima 2001 - 1998

UNIT PACKAGE: 15



22128
(66820-9N00A)
Black Nylon

Cowl & Dash Retaining Clip
Width at Bottom Legs: 19mm
Overall Height: 29.5mm
Nissan 370Z, Leaf & Maxima
2009 - On

UNIT PACKAGE: 25



21850
(26398-ED000)
White Nylon

Tail Light Clip
Top Head Size: 13mm x 13mm
Bottom Head Diameter: 19mm
Stem Length: 10mm
Infiniti M37, M56 & M Hybrid 2013 - On
Nissan Armada, Juke, Pathfinder,
Sentra & Versa 2006 - On

UNIT PACKAGE: 25



21689
(66820-61U00)
Black Nylon

Cowl Grille Retainer
Head Diameter: 11mm
Stem Diameter: 4.5mm
Stem Length: 15mm
Infiniti M45 & Q45 and
Nissan Sentra 1997 - On

UNIT PACKAGE: 25



23851

(01553-03371)
Black Nylon

Windshield Moulding Clip
Lower Corner Moulding
Nissan Pathfinder 1990 - On

UNIT PACKAGE: 25



21588

(80850-CA003)
Black Nylon

Weatherstrip Retainer
Head Diameter: 8mm
Stem Diameter: 5.3mm
Stem Length: 7mm
Murano & Rouge 2003 - On

UNIT PACKAGE: 25



21295

(01553-08961)
Black Nylon

Weatherstrip Retaining Clip
Head Diameter: 10mm
Stem Diameter: 6mm
Stem Length: 8mm
Altima 2009 - On

UNIT PACKAGE: 25



22060

(65810-K2002)
Black Nylon

Hood Seal Retaining Clip
Head Size: 6.5mm x 16mm
Stem Diameter: 3.5mm x 5.5mm
Stem Length: 8mm
Infiniti 2003 - 1997
Nissan 2003 - 1996

UNIT PACKAGE: 25



21229

(65810-K2000)
Black Nylon

Hood Seal Retaining Clip
Head Size: 6.4mm x 16mm
Stem Diameter: 3.5mm x 6mm
Stem Length: 10mm
Nissan Maxima & Pathfinder and
Infiniti I30, I35, Q45 & QX4 2004 - 1996

UNIT PACKAGE: 25



22769

(Nissan: 80850-89916)
Black Nylon

Door Weatherstrip Retainer
Head Size: 4mm x 10mm
Stem Diameter: 5.4mm
Stem Length: 10mm
Infiniti I30 2001 - 1996
I35 2004 - 2002
Nissan Juke 2015 - 2011
Maxima 2003 - 1995

UNIT PACKAGE: 50



17634

(01553-01781)
Black Nylon

Cowl Grille Retainer
Head Diameter: 12mm
Stem Length: 16mm
Stem Diameter: 6mm
240SX 1990-On

UNIT PACKAGE: 25



14355

(01553-00401)
Black Nylon

Retaining Clip
Head Diameter: 11mm
Stem Length: 13mm
Snaps into 5mm Hole
Panel Range: 4mm

UNIT PACKAGE: 50



14349

(Mazda: 9926-40-543;
Nissan: 01553-00291)
Black Nylon

Retaining Clip
Head Diameter: 11mm
Stem Length: 15mm
Panel Thickness: 5mm
Fits into 5.5mm Hole

UNIT PACKAGE: 50



23752

(76913-N9900)
Black

Trim Panel Retaining Clip
Head Diameter: 12mm
Stem Diameter: 6.5mm
Stem Length: 15mm
Nissan

UNIT PACKAGE: 50



23737

(01553-00541)
Nylon Black

Trim Panel Retaining Clip
Head Diameter: 12mm
Stem Diameter: 6.5mm
Stem Length: 14mm
Nissan

UNIT PACKAGE: 50



14352

(76876-W5000)
Black Nylon

Retaining Clip
Head Diameter: 13mm
Stem Length: 13mm
Panel Thickness: 4mm
Fits into 5mm Hole

UNIT PACKAGE: 50



17452
(01553-00545)
Black Nylon

Bumper Fascia Retainer
Head Diameter: 13mm
Stem Length: 15mm
Fits into 5mm Hole
Sentra 1990-On

UNIT PACKAGE: 25



14737
(Nissan: 01553-00172;
Toyota: 90467-07050)
Black Nylon

Retaining Clip
Head Diameter: 13mm
Stem Length: 15mm
Panel Thickness: 3mm
Fits into 5mm Hole

UNIT PACKAGE: 25



14723
(62869-N4700)
Black Nylon

Retaining Clip
Head Diameter: 14mm
Stem Length: 11mm
Panel Thickness: 4mm
Fits into 6mm Hole

UNIT PACKAGE: 25



14353
(76906-T3000)
Black Nylon

Retaining Clip
Head Diameter: 14mm
Stem Length: 16mm
Panel Thickness: 5mm
Snaps into 6mm Hole

UNIT PACKAGE: 50



20381
(Honda: 90667-671-013ZA;
Mitsubishi: MC440901;
Nissan: 62660-48600-1)
Black Nylon

Trim Panel Retaining Clip
Head Diameter: 16mm
Stem Diameter: 7mm
Stem Length: 16mm
Honda, Mitsubishi & Nissan

UNIT PACKAGE: 25



14347
(Nissan: 01553-00202;
Toyota: 90467-10018)
Black Nylon

Retaining Clip
Head Diameter: 18mm
Stem Length: 12mm
Panel Thickness: 4mm
Snaps into 7mm Hole
Nissan & Toyota

UNIT PACKAGE: 50



20671
(Nissan: 01553-0052U, 01553-09001)
Black Nylon

Trim Panel Retaining Clip
Head Diameter: 20mm
Stem Diameter: 9.5mm
Stem Length: 15mm
Frontier 2004 - 1998, Maxima 2003 - 2000,
NV200 2013 - On, Sentra 2000 - 1998,
Versa 2012 - On, 200SX 1998 - 1995

UNIT PACKAGE: 25



25185
(Nissan: 01553-06753)
Black Nylon

Interior Trim Panel Retaining Clip
Head Diameter: 20mm
Stem Diameter: 10mm
Stem Length: 18mm
Overall Height: 20mm
Nissan NV200 2013 - On

UNIT PACKAGE: 10



14356
(01553-00051)
Black Nylon

Retaining Clip
Head Diameter: 20mm
Stem Length: 16mm
Panel Thickness: 7mm
Snaps into 7mm Hole

UNIT PACKAGE: 50



22286
(80287-37F00)
Natural Nylon

Front Door, Garnish & Interior Trim Retaining Clip
Head Diameter: 14mm
Stem Length: 10mm
Overall Height: 11.5mm
Infiniti FX35, FX45, G35, G37 &
Q60 and Nissan Murano 2015 - 2003

UNIT PACKAGE: 25



18948
(Nissan: 01553-0075U; GM: 1644290)
Black Nylon

Hood Insulation Retainer
Head Diameter: 11mm
Stem Diameter: 5.5mm
Stem Length: 17.5mm
Altima & Maxima 2002 - On

UNIT PACKAGE: 25



21519
(01553-01A50)
Black Nylon

Bumper & Trim Retainer
Head Diameter: 12mm
Stem Diameter: 6mm
Stem Length: 15mm
Infiniti FX35, G35, G37, M35, M45 & Q45 and
Nissan 350Z & 370Z 1997 - On

UNIT PACKAGE: 25



20256
(01553-01182)
Black Nylon

Splash Shield Retainer
Head Diameter: 15mm
Stem Diameter: 4.5mm
Stem Length: 14mm
Frontier Truck 1997 - On

UNIT PACKAGE: 50



16776
(Honda: 90667-SA0-003;
Nissan: 76996-01P02)
Black Nylon

Trim Panel Retainer
Head Diameter: 18mm
Stem Length: 20mm
Fits into 6mm Hole

UNIT PACKAGE: 25



22503
(Nissan: 01553-0170U)
Black Nylon

Front Bumper Cover Retainer
Head Diameter: 18mm
Stem Diameter: 8.5mm
Stem Length: 19mm
Nissan Altima 2015 - On

UNIT PACKAGE: 25



22075
(01553-06451)
Black Nylon

**Upper Quarter Trim &
Rear Trunk Seal Retainer**
Head Diameter: 20mm
Stem Diameter: 8.7mm
Stem Length: 16mm

Infiniti G35, J30, JX60, M35, M37, M56, Q45, Q50 & QX60
and Nissan Altima, Pathfinder & Quest 1996 - On

UNIT PACKAGE: 25



16775
(Honda: 90667-SA7-003;
Nissan: 89427-98070)
Black Nylon

Trim Panel Retainer
Head Diameter: 20mm
Stem Length: 15mm
Fits into 5mm Hole

UNIT PACKAGE: 25



21288
(65846-4Z000)
Black Nylon

Hood Insulation Retainer
Head Diameter: 28mm
Stem Diameter: 6mm
Stem Length: 10mm
Altima 2010 - On

UNIT PACKAGE: 15



17237
(65832-F5000, 65846-30F00)
Black Nylon

Hood Insulation Retainer
Outer Diameter: 29.5mm
Stem Diameter: 7mm
Stem Length: 9mm
Nissan 1981-On

UNIT PACKAGE: 15



22898
(Nissan: F5846-30F00)
Black Nylon

Hood Insulation Retainer
Head Diameter: 30mm
Stem Diameter: 6mm
Stem Length: 10mm
Overall Height: 12mm

Infiniti JX35 & QX56 2013 - 2011
QX60 & QX80 2018 - 2014

Nissan Altima, Armada, Frontier, Kicks, Maxima, Murano,
NV200, Pathfinder, Quest, Rogue, Sentra,
Titan & Versa 2009 - On

UNIT PACKAGE: 25



20672
(66820-3S500-C1)
White Nylon

Cowl Vent Retainer
Top Head Diameter: 13mm
Bottom Head Diameter: 16mm
Stem Diameter: 4mm
Stem Length: 13mm
Frontier & Xterra 1998 - On

UNIT PACKAGE: 25



22063
(01553-02903)
White Nylon

**Front Side Lower Fender
Panel Bracket Retainer**
Top Head Diameter: 13mm
Bottom Head Diameter: 12mm
Stem Length: 14mm
Overall Length: 21mm
Infiniti Qx4 & Qx56 and Nissan Pathfinder,
Frontier & Xterra 2010 - 1997

UNIT PACKAGE: 25



21289
(84953-JA00A)
Yellow Nylon

Trim Panel Retainer
Top Head Diameter: 12.5mm
Middle Head Diameter: 16mm
Bottom Head Diameter: 18mm
Stem Diameter: 9.5mm
Stem Length: 14mm
Overall Length: 20mm
Altima 2010 - On

UNIT PACKAGE: 25



23700
(01553-00042)

Door Trim Retaining Panel
Top Head Diameter:13mm
Middle Head Diameter:16mm
Bottom Head Diameter:18mm
Stem Diameter: 8.5mm
Stem Length: 10mm
Nissan

UNIT PACKAGE: 50



20669
(01553-07111)
Black Nylon

Trim Panel Retainer
Top Head Diameter: 13mm
Middle Head Diameter: 15mm
Bottom Head Diameter: 18mm
Stem Diameter: 9mm
Stem Length: 15mm
Overall Length: 20.5mm
Nissan Altima and
Infiniti G35 & Q45 1997 - On

UNIT PACKAGE: 25



22764
(Nissan: 63848-AQ100)
Red Nylon

**Wheel Opening Moulding
& Lift-gate Trim Retainer**
Top Head Diameter: 13mm
Middle Head Diameter: 16mm
Bottom Head Diameter: 18mm
Stem Diameter: 9mm
Stem Length: 11.5mm
Nissan Murano 2013 - 2008
Nissan Rogue 2017 - 2014

UNIT PACKAGE: 20



21414
(80999-VE000)
White Nylon

Trim Panel Retainer with Sealer
Top Head Diameter: 13mm
Middle Head Diameter: 16mm
Bottom Head Diameter: 18mm
Stem Diameter: 9mm
Stem Length: 13mm
Overall Length: 19.5mm
Infiniti & Nissan 1993 - On

UNIT PACKAGE: 25



19731
(84915-0W000)
White Nylon

Trim Panel Retainer
Top Head Diameter: 13mm
Middle Head Diameter: 16mm
Bottom Head Diameter: 17mm
Stem Diameter: 9.5mm
Stem Length: 13mm
Pathfinder 1995 - On

UNIT PACKAGE: 15



22237
(01553-30001)
White Nylon

Trim Panel Retainer
Top Head Diameter: 13mm
Middle Head Diameter: 16.5mm
Bottom Head Diameter: 18mm
Stem Diameter: 9mm
Stem Length: 13mm

Nissan Altima, Cube, GT-R, Murano, Pathfinder, Quest,
Rogue, Sentra, Versa & Versa Note 2007 - On

UNIT PACKAGE: 25



20668
(01553-09791)
White Nylon

Trim Panel Retainer
Top Head Diameter: 13mm
Middle Head Diameter: 16mm
Bottom Head Diameter: 18mm
Stem Diameter: 9mm
Stem Length: 14mm
Overall Length: 20mm
Nissan & Infiniti 1999 - On

UNIT PACKAGE: 15



23989
(01553-10611)
Nylon

Door & Interior Trim Retainer
Top Head Diameter: 13mm
Bottom Head Diameter: 18mm
Stem Diameter: 9.4mm
Stem Length: 13mm
Overall Length: 20mm
Infiniti EX35, FX35/50, G37, M37/56 2008 - On
Nissan 370Z & Juke 2009 - On

UNIT PACKAGE: 25



22832
(Nissan: 01553-10481)
White Nylon

Interior Liftgate Trim Retainer
Top Head Diameter: 13mm
Middle Head Diameter: 16mm
Bottom Head Diameter: 18mm
Stem Diameter: 9.5mm
Stem Length: 16mm
Overall Length: 22mm
Infiniti EX35, EX37, FX35, FX37,
FX50, QX50 & QX70 and
Nissan Murano 2017 - 2009
Xterra 2011 - 2000

UNIT PACKAGE: 25



22768
(Nissan: 84915-0W010)
White Nylon

**Wheelhouse, Trunk Trim
& Package Tray Retainer**
Top Head Diameter: 14mm
Middle Head Diameter: 16mm
Bottom Head Diameter: 18mm
Stem Diameter: 9mm
Stem Length: 10mm
Overall Length: 16.5mm

Infiniti QX4 2003 - 1997, Nissan Pathfinder 2004 - 1996
Sentra 2013 - On

UNIT PACKAGE: 25



13945

(01553-S3500)
White Nylon

Door Trim Panel Retainer

Bottom Head Diameter : 19mm
Top Head Diameter : 15mm
Stem Diameter : 9mm
Stem Length : 18mm
Trucks

UNIT PACKAGE: 50



18166

(80875-85E00)
Black Nylon

Trim Panel Retainer

Head Diameter: 10mm
Stem Length: 10mm
Stem Diameter: 4mm
Maxima 1989-On

UNIT PACKAGE: 25



21633

(80850-89900)
White Nylon

Weatherstrip Retainer

Head Size: 6mm x 16mm
Stem Diameter: 6.5mm
Stem Length: 12mm
Nissan Maxima and
Infiniti I30, I35 & M45 2004 - 2000

UNIT PACKAGE: 25



22875

(Nissan: 80850-1FA0B)
Natural Nylon

Door Weatherstrip Retainer

Top Head Size: 5mm x 15mm
Bottom Head Diameter: 8.5mm
Stem Size: 4.5mm x 7mm
Stem Length: 8.3mm
Nissan Cube 2014 - 2009
Juke 2017 - 2011

UNIT PACKAGE: 50



19724

(65810-K2009)
White Nylon

**Hood to Cowl
Seal Retainer**

Head Size: 6mm x 16mm
Stem Length: 15mm
Fits into 5mm Hole
Infiniti & Pathfinder 1992 - On

UNIT PACKAGE: 25



19684

(01553-09311)
Blue Nylon

Weatherstrip Retainer

Head Size: 7mm x 16mm
Stem Length: 12mm
Fits into 6mm Hole
Altima & Sentra 1994-On

UNIT PACKAGE: 25



22107

(80850-JM01A)
Black Nylon

Weatherstrip Retainer

Head Size: 6mm x 15mm
Stem Size: 5.6mm x 7mm
Stem Length: 12mm
Overall Length: 16mm
Nissan Rogue 2008 - On

UNIT PACKAGE: 25



16783

(66824-01G00)
Black Nylon

Push-Type Retainer

Head Diameter: 12mm
Stem Length: 8mm (Excluding the Pin)
Fits into 6mm Hole

UNIT PACKAGE: 25



25412

(Nissan: 79916-JD00A)
Black Nylon

Liftgate Push-Type Retainer

Head Diameter: 13mm
Stem Length: 8.5mm
Stem Diameter: 6.3mm x 7mm
Fits into 6.3mm Hole
Shoulder Length: 3.5mm
Nissan Rouge Sport 2019 - On

UNIT PACKAGE: 25



21159

(66820-AX020)
Black Nylon

**Cowl Vent & Outside Mirror
Push-Type Retainer**

Head Diameter: 14mm
Stem Length: 10mm
Fits into 6mm Hole
Pathfinder & Versa 2005 - On

UNIT PACKAGE: 15



16859

(Nissan: 66860-01W01;
GM: 94051993)
Black Nylon

**Cowl Panel to Reinforcement Plate &
Engine Splash Shield Retainer**

Head Diameter: 14mm (9/16")
Stem Length: 16mm (5/8")
Fits into 6mm (1/4") Hole
Nissan 1980-On
Geo Storm 1990-On

UNIT PACKAGE: 25

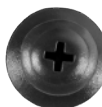

14696

(Nissan: 10998-30880;
Honda: 90684-SA5-003;
Isuzu: 8942981190)
Black Nylon

Push-Type Retainer

Head Diameter: 15mm
Stem Length: 11mm
Fits into 6mm Hole

UNIT PACKAGE: 25



21620

(01553-06071)
Black Nylon

**Rear Duct Finishing Panel
Push-Type Retainer**

Head Diameter: 15mm
Stem Length: 14mm
Fits into 5mm Hole
Cube S, SL, Krom & Leaf 2012 - On

UNIT PACKAGE: 15



20349

(Nissan: 01553-09611;
Toyota: 90467-08185)
Black Nylon

**Bumper Clip
Push-Type Retainer**

Head Diameter: 18mm
Stem Length: 10mm (Excluding the Pin)
Fits into 8mm Hole
Maxima 1994 - On
Toyota & Lexus 2002 - On

UNIT PACKAGE: 15



18265

(76882-57A00)
Black Nylon

**Body Side Moulding
Push-Type Retainer**

Head Diameter: 16mm
Stem Length: 20mm
Fits into 8mm Hole
Sentra 1986-On

UNIT PACKAGE: 25



21311

(01553-0038U)
Gray Nylon

Bumper Push-Type Retainer

Head Diameter: 18mm
Stem Length: 12mm
Fits into 8mm Hole
Frontier, Pathfinder & Xterra 2005 - On

UNIT PACKAGE: 10



14726

(63844-01A99)
Black Nylon

Push-Type Retainer

Head Diameter: 17mm
Stem Length: 18mm
Fits into 8mm Hole

UNIT PACKAGE: 25



19246

(01553-09241)
Black Nylon

Bumper Push-Type Retainer

Head Diameter: 18mm
Stem Length: 15mm
Fits into 10mm Hole
240SX & Maxima 1994-On

UNIT PACKAGE: 15



16784

(Nissan: 80999-05N07;
Toyota: 90467-07043)
Black Nylon

Push-Type Retainer

Head Diameter: 18mm
Stem Length: 11mm (Excluding the Pin)
Fits into 7mm Hole

UNIT PACKAGE: 25



20613

(63848-40Y00)
Black Nylon

Front Bumper Push-Type Retainer

Head Diameter: 18mm
Stem Length: 20mm
Fits into 9mm Hole
Frontier & Xterra 1998 - On

UNIT PACKAGE: 15



22039

(01553-2DR9A)
Black Nylon

Push-Type Retainer

Top Head Diameter: 16mm x 19mm
Bottom Head Diameter: 20mm
Stem Length: 12mm
Fits into 8mm Hole
Infiniti G20, JX35, Q45 & QX60 and Nissan Frontier,
Maxima, NV, Pathfinder, Sentra,
Versa & Xterra 2002 - On

UNIT PACKAGE: 15



20327

(63848-9E001)
Black Nylon

**Bumper Fascia
Push-Type Retainer**

Head Diameter: 18mm
Stem Length: 19mm (Excluding the Pin)
Fits into 9mm Hole
Altima 1997 - On

UNIT PACKAGE: 10



16782

(Honda: 91545-SE0-003-W;
Nissan: 63848-01G00)
Black Nylon

Push-Type Retainer

Head Diameter: 20mm
Stem Length: 8mm (Excluding the Pin)
Fits into 8mm Hole

UNIT PACKAGE: 25



21631
(84995-3J101)
Black Nylon

Push-Type Retainer
Head Diameter: 20mm
Stem Length: 8mm (Excluding the Pin)
Fits into 8mm Hole
Sentra 2007 - On

UNIT PACKAGE: 15



21134
(01553-09431)
Black Nylon

Front Bumper Push-Type Retainer
Head Diameter: 20mm
Stem Length: 11mm (Excluding the Pin)
Fits into 8mm Hole
Maxima 2004 - On

UNIT PACKAGE: 15



21545
(01553-08231)
Black Nylon

Front & Rear Bumper and Grille Push-Type Retainer
Head Diameter: 20mm
Stem Length: 15mm
Fits into 8mm Hole
Nissan Murano, 240 SX & 350Z and Infiniti FX35, FX45 & Q45 1995 - On

UNIT PACKAGE: 25



22368
(Nissan: 84937-6P000)
Black Nylon

Trunk Knit Hook Push-Type Retainer
Top Head Diameter: 24mm
Bottom Head Diameter: 27mm
Stem Length: 10mm
Overall Length: 25mm
Fits into 8mm Hole
Infiniti Q45 2000 - 1997
Nissan 350Z, Altima & GT-R 2003 - On

UNIT PACKAGE: 15



16858
(Nissan: 63844-01A00;
Kia: MNA01-56-145;
Mazda: NA01-56-145;
Ford: MNA01-56145, NA01-56145)
Black Nylon

Inner Fender Push-Type Retainer
Head Diameter: 20mm (25/32")
Stem Length: 18mm (23/32")
Fits into 8mm (5/16") Hole
Nissan 1980-On
Mazda, Kia & Ford

UNIT PACKAGE: 25



16000
(Honda: 90675-SB3-003;
Mazda: FB01-56-964;
Nissan: 63876-95596)
Black Nylon

Push-Type Retainer
Head Diameter: 20mm
Stem Length: 9mm
Fits into 8mm Hole

UNIT PACKAGE: 25



20348
(63878-01E10)
Black Nylon

Push-Type Retainer
Head Diameter: 20mm
Stem Length: 22mm
Fits into 8mm Hole
Maxima 1994 - On

UNIT PACKAGE: 15



19905
(01553-10051)
Black Nylon

Push-Type Retainer
Head Diameter: 20mm
Stem Length: 8mm (Excluding the Pin)
Fits into 8mm Hole
Maxima 1999 - On

UNIT PACKAGE: 15



19274
(01553-09321)
Black Nylon

Push-Type Retainer
Head Diameter: 20mm
Stem Length: 9mm (Excluding the Pin)
Fits into 8mm Hole
Maxima & 300ZX 1994-On

UNIT PACKAGE: 15



21192
(Nissan: 01553-05323, 01553-05933, 01553-10721; Mazda: L33X13209)
Black Nylon

Cowl, Bumper, Fender Liner & Radiator Grille Push-Type Retainer
Head Diameter: 20mm
Stem Length: 12mm
Fits into 8mm Hole
Infiniti FX35, FX45, G35 and Nissan 2003 - On,
Frontier 2019 - 2005, Versa Note 2017, NV200 2013 - On;
Mazda 2, 3, 5, 6, CX-5, CX-7 & CX-9 2007 - On

UNIT PACKAGE: 10



20953
(11296-AG000)
Black Nylon

Front Bumper and Radiator Support Push-Type Retainer
Head Diameter: 20mm
Stem Length: 13mm
Fits into 8mm Hole
Infiniti FX 35/45 and Nissan Altima,
Maxima & Quest 2002 - On

UNIT PACKAGE: 25



17350

(Honda 91516-SK7-013;
Nissan 01553-00344)
Black Nylon

Splash Shield Push-Type Retainer

Phillips Drive
Hex: 10mm

Head Diameter: 20mm
Stem Length: 15mm
Fits into 8mm Hole

Civic 1992 - On Nissan XTerra, Frontier, & Quest 1999 - On

UNIT PACKAGE: 10



17472

(Mitsubishi: MB547806;
Nissan: 63854-01A00)
Black Nylon

Front Bumper Fascia Push-Type Retainer

Head Diameter: 20mm
Stem Length: 20mm
Fits into 8mm Hole
300ZX 1990-On

UNIT PACKAGE: 15



17378

(01553-03101)
Black Nylon

Bumper & Fascia Push-Type Retainer

Head Diameter: 22mm
Stem Length: 14mm
Fits into 8mm Hole
Shoulder Diameter: 11mm
Nissan 1986 - On

UNIT PACKAGE: 15



20753

(01553-03201)
Black Nylon

Front & Rear Bumper Push-Type Retainer

Head Diameter: 22mm
Stem Length: 21mm
Fits into 8mm Hole
Nissan 1982 - On

UNIT PACKAGE: 10



17347

(01553-06721)
Black Nylon

Front & Rear Bumper Cover Push-Type Retainer

Head Diameter: 20mm
Stem Length: 11mm (Excluding the Pin)
Fits into 8mm Hole
Maxima & Infiniti 1990 - On

UNIT PACKAGE: 15



21361

(GM: 11561874;
Nissan: 622A2-9E000A)
Black Nylon

Bumper Cover Push-Type Retainer

Head Diameter: 25mm
Stem Length: 29mm
Fits into 7mm Hole
Chevrolet Malibu 2008 - On
Saturn Aura 2007 - On
Pontiac G6 2010 - On
Nissan Altima 1997 - On

UNIT PACKAGE: 15



22762

(Nissan: 62828-AG000)
Black Nylon

Wheel Wind Deflector Push-Type Retainer

Head Diameter: 26mm
Stem Length: 9mm (Excluding Pin)
Fits into 16mm Hole
Nissan Versa 2013 - On

UNIT PACKAGE: 15



16725

(66814-01G00)
Black Nylon

Cowl Grille Retainer

Head Size: 8mm x 12mm
Stem Length: 8mm
Fits into 6mm Square Hole
Nissan Pick-Up 1986 - On

UNIT PACKAGE: 25



14727

(Nissan: 63844-D0100;
GM: 94221150; Isuzu: 8942211500)
Black Nylon

Push-Type Retainer

Screw: 5mm x 14mm
Head Size: 14mm x 22mm
Stem Length: 9mm
Fits into 7mm Hole

UNIT PACKAGE: 25



16843

(Mazda: BF82-50-233;
Nissan: 01553-01393)
Black Nylon

Bumper Cover Retainer

Head Size: 20mm x 30mm
Stem Length: 18mm
Fits into 10mm Hole

UNIT PACKAGE: 10



22275
(28945-CA000)
Black Nylon

Tube/Cable Routing Clip
Holds 7mm Diameter Tube/Cable
Overall Height: 21.5mm
Nissan Murano & Rogue 2012 - On

UNIT PACKAGE: 25



21999
(01552-00661)
Natural Nylon

Tube/Cable Routing Clip
Tube/Cable Diameter: 5mm
Snaps into 6mm Hole
Nissan

UNIT PACKAGE: 15



22573
(Nissan: 65625-8J000)
Black Nylon

Hood Release Cable Clip
Holds 6mm Diameter Cable
Fits into 6mm Hole
Nissan Altima, Maxima, Murano, NV1500,
NV2500, NV3500, Pathfinder, Rogue, Sentra,
Versa & Versa Note 2016 - On

UNIT PACKAGE: 50



16780
(Nissan: 99604-H1400;
Toyota: 58788-13010)
Natural Nylon

Hood Prop Rod Clip
Holds 11mm Diameter Rod
Fits into 10mm x 12mm Hole

UNIT PACKAGE: 10

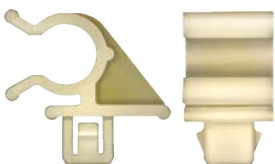

22362
(65722-50A00)
Natural Nylon

Hood Prop Rod Clip
Holds 8mm Diameter Rod
Overall Height: 20.5mm
Fits into 8mm Square Hole
Nissan Juke 2013 - 2011

UNIT PACKAGE: 15



14337
(84653-N7400)
Black Nylon

Tube/Cable Routing Clip
Holds 5mm Tube or Cable
Snaps into 5mm Hole

UNIT PACKAGE: 25



14345
(24220-89986)
White Nylon

Hood Prop Rod Clip
Holds 10mm Rod
Snaps into 8mm Hole

UNIT PACKAGE: 10



21309
(65722-EA000)
Black Nylon

Hood Prop Rod Clip
Rod Size: 8mm
Overall Length: 33mm
Frontier, Pathfinder & Xterra 2005 - On

UNIT PACKAGE: 10

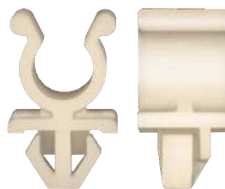

22358
(65722-01E00)
White Nylon

Hood Prop Rod Clip
Holds 8mm Diameter Rod
Overall Height: 23mm
Fits into 9mm Hole
Infiniti G20 & QX4 2003 - 1991
Nissan 200SX, 240SX, 300ZX, 370Z, Altima, Frontier,
Pathfinder, Sentra, Stanza & Xterra 1986 - On

UNIT PACKAGE: 15



22903
(Nissan: 65829-50A00)
Black Rubber

Hood Bumper
Head Diameter: 15mm
Overall Height: 20mm
Fits into 8mm Hole
Infiniti FX35, FX45 & I35 2008 - 2002
QX56 2010 - 2004
Nissan Armada Cube, Frontier, Maxima,
Rogue, Sentra, Titan, Versa,
Versa Note & Xterra 2000 - On

UNIT PACKAGE: 25



22851
(Nissan: 74816-AX000)
White Nylon

Wheel Liner Body Hole Plug
Head Diameter: 16mm
Stem Size: 12.5mm x 15.7mm
Stem Length: 8mm
Nissan Altima 2007 - On;
Maxima & Rogue Sport 2016 - On Murano, Pathfinder,
Versa & Xterra 2015 - 2003

UNIT PACKAGE: 25



22761
(Nissan: 01658-01361, 24253-M9400)
Black Rubber

Hole Plug
Head Diameter: 17mm
Overall Height: 6mm
Fits into 12mm Hole
Nissan 200SX 1997 - 1995
350Z, 370Z, Altima, Armada, Cube, Frontier,
GT-R, Juke, Lead, Maxima, Pathfinder,
Quest, Rogue, Sentra, Versa Note & Xterra 1999 - On

UNIT PACKAGE: 30



22904
(Nissan: 74849-JD00A)
Black Rubber

Hole Plug
Head Diameter: 20mm
Fits into 12.5mm Hole
Nissan Versa & Versa Note 2011 - On

UNIT PACKAGE: 25



22919
 (Nissan: 74849-JD00B)
 Black Nylon
Hole Plug
 Head Diameter: 22mm
 Fits into 16mm Hole
 Nissan Versa Note 2015 - 2014

UNIT PACKAGE: 25



22896
 (Nissan: 01658-02133)
 Black Rubber
Body Hole Plug
 Head Diameter: 22mm
 Fits into 12.5mm Hole
 Infiniti JX35, Q40, Q50, Q60, Q70, Q70L, QX50, QX60 & QX70 and Nissan 370Z, Altima, Cube, Frontier, GT-R, Leaf, Murano, Pathfinder, Quest, Rogue, Rogue Sport, Sentra, Versa, Versa Note & Xterra 2014 - On

UNIT PACKAGE: 25



21646
 (80874-AX000)
 Black Nylon
Hole Plug
 Head Diameter: 25mm
 Fits into 18mm Hole
 Nissan Juke & Murano and Infiniti EX35 2003 - On

UNIT PACKAGE: 25



22820
 (Nissan: 01658-02121)
 Black Rubber
Door Hole Plug
 Head Diameter: 30mm
 Overall Height: 8mm
 Fits into 21mm Hole
 Nissan 200SX & 240SX 1999 - 1995
 350Z 2008 - 2003, 370Z, Altima, Armada, Cube, Frontier & GT-R 2002 - On

UNIT PACKAGE: 25



21637
 (01553-05131)
 Black Nylon
Wheel Liner, Cowl Insulator & Trim Flange Clip
 Flange Diameter: 25mm
 Hex: 10.5mm
 Overall Height: 12.5mm
 Nissan 370Z, Altima, Cube, Frontier, GT-R, Juke, Leaf, Maxima, Murano, NV, Pathfinder, Quest, Rouge, Versa & Xterra and Infiniti EX35, FX35, FX50, G25, G35, G37, J30, M35, M45 & Q45 1993 - On

UNIT PACKAGE: 15



25186
 (Nissan: 63848-5L300)
 Black Nylon
Cowl Trim Retainer Nut
 Thread Size: M5-0.8
 Flange O.D.: 20mm
 Hex Size: 14mm
 Height: 10mm
 Nissan 350Z 2009 - 2003; 370Z, GT-R 2009 - On; Armada 2017 - On; Leaf 2017 - 2011; Maxima 2003 - 1997; NV200 2013 - On; Infiniti EX35 2017 - 2008; EX37 2017 - 2013; FX35 2012 - 2003; FX37 2013; FX45, G35 2008 - 2003; FX50 2013 - 2009; G20 2002 - 1999; G25 2013 - 2011; G37 2015 2008; I30 2001 - 1998; I35 2004 - 2002; M35 2001 - 2006; M37, M56, Q70 2019 - 2011; M45 2010 - 2006; Q40 2015 - 2014; Q50, Q60 2014 - On; QX50 2018 - On; QX 56, QX80 2011 - On; QX70 2017 - 2014

UNIT PACKAGE: 10



20380
 (Not Supplied by O.E.M.)
 Black Nylon

Photo not actual size

Cable Strap
 Width: 5mm (3/16")
 Length: 200mm (8")
 Max. Bundle Diameter: 44mm (1-3/4")
 Fits into 6.3mm (1/4") Hole
 Import Cars

UNIT PACKAGE: 25



21259
 (24225-89960)
 Black Nylon

Photo not actual size

Cable Strap
 Overall Length: 200mm (8")
 Width: 8mm (5/16")
 Maximum Bundle Diameter: 55mm (2-3/16")
 Snaps into 8mm (5/16") Hole
 Nissan 2005 - On

UNIT PACKAGE: 25



16340
 (54229-0201P)
 Zinc
Window Crank Handle Retaining Clip

UNIT PACKAGE: 100



19147
(62228-51S00)
Front Bumper Retainer
300ZX 1992 - On

UNIT PACKAGE: 10



22198
(11296-3TA0A)
Zinc Organic
Trim Retaining Clip
Overall Height: 18.5mm
Width from Ear to Ear: 11mm
Nissan Altima 2013 - On

UNIT PACKAGE: 50



21664
(63848-9Y000)
Black Nylon
Fender Apron Clip
Width: 20mm
Width at Wings: 30mm
Overall Length: 30mm
Nissan Altima, Maxima, Murano, Pathfinder, Quest & 370Z and Infiniti EX35, FX35, FX50, G35, G37, M35, M37, M45 & M56 2005 - On

UNIT PACKAGE: 10



21017
(76882-0M000)
White Nylon
Nylon U-Nut
Screw Size: M4.8 (#10)
Panel Range: Up to 1.5mm
Center of Hole to Edge: 8mm
Nissan & Infiniti 1995 - On

UNIT PACKAGE: 15



17193
(63848-D0100)
Black Nylon
Nylon U-Nut
Fender/Wheel Housing
Screw Size: M5.5 (#12)
Width: 20mm
Length: 20mm
Panel Range: Up to 1mm
Center of Hole to Edge: 9mm

UNIT PACKAGE: 15



19735
(63848-5HA0A)
Black Nylon
Fender Clip U-Nut
Screw Size: M4.8 (#10)
Width: 20mm
Length: 32mm
Panel Range: Up to 2mm
Center of Hole to Edge: 8mm
Maxima & 240SX 1994 - On

UNIT PACKAGE: 15



17385
(63848-D4000)
Black Nylon
Nylon U-Nut
Fender/Wheel Housing
Screw Size: M5.5 (#12)
Width: 31mm
Length: 22mm
Panel Range: Up to 2mm
Center of Hole to Edge: 9mm
Sentra

UNIT PACKAGE: 10



21459
(01241-00881)
Black Nylon
Nylon U-Nut
with Captive Metal Hex Nut
Thread: M6 - 1.0
Center of Hole to Edge: 14mm
Panel Range: Up to 4mm
Nissan Altima, Maxima & 240SX and Infiniti I30 2001 - 1993

UNIT PACKAGE: 10



25092
(Infiniti & Nissan: 01241-01051)
Black Nylon & Black Metal Nut
License Plate Bracket U-Nut
with Encapsulated Hex Nut
Screw Size: M6-1.0
Width: 16mm
Length: 28mm
Panel Range: 3.5mm
Center of Hole To Edge: 13.5mm
Infiniti G35 2007 - 2004, G37 2013 - 2009, M35, M45 2009- 2006, Q60 2015 - 2014, Q70 2019 - 2014, QX50 2017 - On, QX80 2019 - 2017
Nissan 350Z 2009 - 2003; 370Z 2009 - On, Armada 2017 - On, Cube 2014 - 2009, Frontier 2019 - 2013, Leaf 2017 - 2011, Pathfinder 1999 - 1996, Rouge 2013 - 2009, Sentra 2018 - 2013, Versa 2019 - 2007

UNIT PACKAGE: 25



13225
Plated
U-Type Nut
Screw Size: 4.2mm (#8)
Width: 11mm
Length: 16.5mm
Panel Range: .5mm-2.5mm
Center of Hole to Edge: 8mm

UNIT PACKAGE: 50

OPEL, PEUGEOT AND CITROEN CLIPS & FASTENERS



13216

Zinc

U-Type Nut

Screw Size: 4.8mm
Panel Range: .9mm-2.0mm
Center of Hole to Edge: 8mm

UNIT PACKAGE: 25



13220

(Mercedes: 000-994-09-45;
Volvo: 946-418; Opel: 20-72-175)
Plated

U-Type Nut

Screw Size: 6.3mm
Panel Range: .7mm-1.5mm
Center of Hole to Edge: 13mm

UNIT PACKAGE: 50

PEUGEOT AND CITROEN CLIPS & FASTENERS



21931

(Peugeot & Citroen: 7136.J7;
Renault & Dacia: 77-03-081-163)
Natural Nylon

Nylon Nut

Screw Size: M2.9 (#4)
Head Size: 13mm x 13mm
Stem Length: 10mm
Peugeot, Citroen, Renault & Dacia

UNIT PACKAGE: 25



21949

Black Nylon

Weatherstrip Retainer

Head Size: 5mm x 12mm
Stem Diameter: 7mm
Stem Length: 10mm
Peugeot & Citroen

UNIT PACKAGE: 25



21963

Light Gray Nylon

Screw Grommet

Screw Size: M2.9 (#4)
Head Diameter: 16mm
Stem Length: 15mm
Peugeot & Citroen

UNIT PACKAGE: 10



21936

(6992.07)
Black Nylon

Trim Panel Retainer

Head Diameter: 11.5mm
Stem Diameter: 5.5mm
Stem Length: 12mm
Peugeot & Citroen

UNIT PACKAGE: 25



21943

(8749.Q5)
Gray Nylon

Trim Retaining Clip

Head Diameter: 12mm
Stem Diameter: 7.5mm
Stem Length: 13mm
Peugeot & Citroen

UNIT PACKAGE: 25



21975

(Peugeot & Citroen: 6991.43;
Renault & Dacia: 77-03-077-059)
White Nylon

Trim Panel Retainer

Top Head Diameter: 14mm
Bottom Head Diameter: 17mm
Stem Diameter: 9mm
Stem Length: 10mm
Peugeot, Citroen, Renault & Dacia

UNIT PACKAGE: 25



21919

Black Nylon

Weatherstrip Retaining Clip

Head Size: 7mm x 12mm
Stem Diameter: 7mm
Stem Length: 9mm
Peugeot, Citroen, Renault & Dacia

UNIT PACKAGE: 25



21871

(Peugeot & Citroen: 6995.A3;
Renault & Dacia: 77-03-077-111)
White Nylon

Trim Panel Retainer with Sealer

Top Head Diameter: 13mm
Bottom Head Diameter: 16.5mm
Stem Diameter: 8.7mm
Stem Length: 11mm
Peugeot, Citroen, Renault & Dacia

UNIT PACKAGE: 25



21918

(9025.J8)
Black Nylon

Weatherstrip Retaining Clip

Head Size: 7mm x 12mm
Stem Diameter: 8mm
Stem Length: 9mm
Peugeot, Citroen, Renault & Dacia

UNIT PACKAGE: 25



22432

(Chrysler: 68093998-AA; Fiat: 71728806;
Citroen & Peugeot: 856543)
White Nylon

Body Side Moulding Clip with Sealer

Top Head Size: 11mm x 12mm
Bottom Head Size: 15mm x 19mm
(Including the Sealer)
Stem Diameter: 10.3mm
Stem Length: 13mm
Fiat, Citroen, Peugeot,

Chrysler Postal Minivan Vehicles &
Dodge Ram Promaster 2014 - On

UNIT PACKAGE: 25



21920

Black Nylon

Weatherstrip Retaining Clip

Head Size: 9mm x 18mm
Stem Diameter: 8.5mm
Stem Length: 10mm
Peugeot, Citroen, Renault & Dacia

UNIT PACKAGE: 25





23783
(01553-S3500)
White Nylon

Door Trim Panel Retainer
Top Head Diameter: 13mm
Bottom Head Diameter: 19mm
Stem Diameter: 8.8mm
Stem Length: 17mm
Nissan Trucks

UNIT PACKAGE: 50



21916
(Peugeot & Citroen: 8335.TE;
Renault & Dacia: 82-00-700-969)
Yellow Nylon

Trim Panel Retainer
Top Head Diameter: 12.3mm
Middle Head Diameter: 15mm
Bottom Head Diameter: 18mm
Stem Diameter: 12mm
Stem Length: 13mm
Peugeot, Citroen, Renault & Dacia

UNIT PACKAGE: 25



21895
(Peugeot & Citroen: 6991.ZI;
Renault & Dacia: 82-00-909-084)
Blue Nylon

Trim Panel Retainer
Top Head Diameter: 13mm
Middle Head Diameter: 16mm
Bottom Head Diameter: 18mm
Stem Diameter: 12mm
Stem Length: 12mm
Peugeot, Citroen, Renault & Dacia

UNIT PACKAGE: 25



21944
(8742.G2)
Green & White Nylon

Trim Panel Retainer
Top Head Diameter: 12.5mm
Middle Head Diameter: 14mm
Bottom Head Diameter: 18mm
Stem Diameter: 10.5mm
Stem Length: 12mm
Peugeot, Citroen, Renault & Dacia

UNIT PACKAGE: 10



21978
(6992.J4)
White Nylon

Trim Panel Retainer
Top Head Diameter: 14mm
Middle Head Diameter: 16.5mm
Bottom Head Diameter: 17mm
Stem Diameter: 9mm
Stem Length: 10mm
Peugeot & Citroen

UNIT PACKAGE: 25



21822
(Peugeot & Citroen: 6822.LL;
Tesla: 1047307-00-A)
White Nylon

Door Panel, Cowl, Interior Trim, Headliner, Fender, Liftgate Retainer
Top Head Diameter: 13mm
Middle Head Diameter: 16mm
Bottom Head Diameter: 18mm
Stem Diameter: 8.5mm x 9mm
Stem Length: 14mm
Overall Length: 20mm
Peugeot, Citroen & Toyota; Tesla 3 2017 - On;
S 2012 - On; X 2015 - On; Y 2020 - On

UNIT PACKAGE: 25



21884
(6990.50)
White Nylon

Trim Panel Retainer
Top Head Diameter: 11mm
Middle Head Diameter: 16mm
Bottom Head Diameter: 18mm
Stem Diameter: 8mm
Stem Length: 13mm
Overall Length: 21.3mm
Peugeot & Citroen

UNIT PACKAGE: 25



21882
(Peugeot & Citroen: 6991.F0;
Renault & Dacia: 77-03-072-261)
Black Nylon

Push-Type Retainer
Torx® Drive (T27)
Head Diameter: 12mm
Stem Length: 14mm
Fits into 6mm Hole
Peugeot, Citroen, Renault & Dacia

UNIT PACKAGE: 25



21875
(Peugeot & Citroen: 6555.LE;
Renault & Dacia: 77-03-072-236)
Black Nylon

Push-Type Retainer
Torx® Drive (T27)
Head Diameter: 12.5mm
Stem Length: 9mm
Fits into 6mm Hole
Peugeot, Citroen, Renault & Dacia

UNIT PACKAGE: 25



21966
Yellow Nylon

Nylon U-Nut
Screw Size: M4.2 (#8)
Panel Range: Up to 2.5mm
Center of Hole to Edge: 7mm
Overall Height: 12.5mm
Peugeot & Citroen

UNIT PACKAGE: 10

RENAULT AND DACIA CLIPS & FASTENERS



21931
(Peugeot & Citroen: 7136.J7;
Renault & Dacia: 77-03-081-163)
Natural Nylon

Nylon Nut
Screw Size: M2.9 (#4)
Head Size: 13mm x 13mm
Stem Length: 10mm
Peugeot, Citroen, Renault & Dacia

UNIT PACKAGE: 25



9377
(Renault: 8934-201-263; Chrysler: 6000943)
White Nylon

Radiator Grille Nut
Screw Size: #8

UNIT PACKAGE: 100



11855
(Renault: 8934-201-262; GM: 9669486)
Natural Nylon

Screw Size: #8
Rear License Plate Bracket Nut
AMC-Renault
Side Marker Nut
GM 1980-On

UNIT PACKAGE: 25



21961
(Peugeot & Citroen: 8749.ZA;
Renault & Dacia: 77-03-081-232)
Natural Nylon

**Screw Grommet with
Black Rubber Sealer**
Screw Size: M4.2 (#8)
Head Size: 10.5mm x 17.5mm
Stem Length: 15mm
Peugeot, Citroen, Renault & Dacia

UNIT PACKAGE: 10



12713
(GM: 10032838; 1264963;
Chrysler: 6031869;
Renault: 8934-201-602)
Natural Nylon

**High Torque
Screw Grommet**
Screw Size #6

UNIT PACKAGE: 25



13966
(8934-201-767)
Black Nylon

Tubular Barrel Nut
For 3/16" Stud
Barrel Length 17/64"
Head Diameter: 5/16"
Head Thick 1/32"
For Hole Diameter 17/64"

UNIT PACKAGE: 100



21918
(Peugeot & Citroen: 9025.J8)
Black Nylon

Weatherstrip Retaining Clip
Head Size: 7mm x 12mm
Stem Diameter: 8mm
Stem Length: 9mm
Peugeot, Citroen, Renault & Dacia

UNIT PACKAGE: 25



21920
Black Nylon

Weatherstrip Retaining Clip
Head Size: 9mm x 18mm
Stem Diameter: 8.5mm
Stem Length: 10mm
Peugeot, Citroen, Renault & Dacia

UNIT PACKAGE: 25



21905
(82-00-721-200)
Gray Nylon

Trim Panel Retainer
Head Diameter: 21mm
Stem Diameter: 7.5mm
Stem Length: 19mm
Renault & Dacia

UNIT PACKAGE: 25



21805
(77-03-077-435)
Black Nylon

Retainer
Head Diameter: 35mm
Stem Diameter: 10mm x 10.5mm
Stem Length: 22mm
Renault and Dacia

UNIT PACKAGE: 25



21806
(77-03-077-225)
Black Nylon

Retainer
Head Diameter: 35mm
Stem Diameter: 10.5mm
Stem Length: 22mm
Renault and Dacia

UNIT PACKAGE: 25



21495
(VW: 7L5-853-994)
Blue Nylon

Trim Panel Retainer
Top Head Diameter: 13mm
Bottom Head Diameter: 18mm
Stem Diameter: 9mm
Stem Length: 14mm
Renault, VW & Audi

UNIT PACKAGE: 25

RENAULT AND DACIA CLIPS & FASTENERS

Sec. 21



21871

(Peugeot & Citroen: 6995.A3;
Renault & Dacia: 77-03-077-111)
White Nylon

Trim Panel Retainer with Sealer
Top Head Diameter: 13mm
Bottom Head Diameter: 16.5mm
Stem Diameter: 8.7mm
Stem Length: 11mm
Peugeot, Citroen, Renault & Dacia

UNIT PACKAGE: 25



21975

(Peugeot & Citroen: 6991.43;
Renault & Dacia: 77-03-077-059)
White Nylon

Trim Panel Retainer
Top Head Diameter: 14mm
Bottom Head Diameter: 17mm
Stem Diameter: 9mm
Stem Length: 10mm
Peugeot, Citroen, Renault & Dacia

UNIT PACKAGE: 25



21917

Yellow Nylon

Trim Panel Retainer with Sealer
Top Head Diameter: 12.3mm
Middle Head Diameter: 15mm
Bottom Head Diameter: 18mm
Stem Diameter: 12mm
Stem Length: 13mm
Overall Length: 19mm
Renault & Dacia

UNIT PACKAGE: 15



21916

(Peugeot & Citroen: 8335.TE;
Renault & Dacia: 82-00-700-969)
Yellow Nylon

Trim Panel Retainer
Top Head Diameter: 12.3mm
Middle Head Diameter: 15mm
Bottom Head Diameter: 18mm
Stem Diameter: 12mm
Stem Length: 13mm
Overall Length: 19mm
Peugeot, Citroen, Renault & Dacia

UNIT PACKAGE: 25



21895

(Peugeot & Citroen: 6991.Z1;
Renault & Dacia: 82-00-909-084)
Blue Nylon

Trim Panel Retainer
Top Head Diameter: 13mm
Middle Head Diameter: 16mm
Bottom Head Diameter: 18mm
Stem Diameter: 12mm
Stem Length: 12mm
Peugeot, Citroen, Renault & Dacia

UNIT PACKAGE: 25



21944

(Peugeot & Citroen: 8742.G2)
Green & White Nylon

Trim Panel Retainer
Top Head Diameter: 12.5mm
Middle Head Diameter: 14mm
Bottom Head Diameter: 18mm
Stem Diameter: 10.5mm
Stem Length: 12mm
Peugeot, Citroen, Renault & Dacia

UNIT PACKAGE: 10



21873

(BMW: 51-43-7-001-491)
White Nylon

Trim Panel Retainer
Top Head Diameter: 14mm
Middle Head Diameter: 15mm
Bottom Head Diameter: 18mm
Stem Diameter: 9.5mm
Stem Length: 14mm
Renault, Dacia & BMW

UNIT PACKAGE: 25



13475

(VW: 175-867-299;
Renault: 8934-201-681)
White Nylon

Trim Panel Retainer
Head Diameter: 19mm
Stem Length: 18mm
Stem Diameter: 9mm
AMC Renault 1984-On
VW 1982-On

UNIT PACKAGE: 50



21882

(Peugeot & Citroen: 6991.F0;
Renault & Dacia: 77-03-072-261)
Black Nylon

Push-Type Retainer
Torx® Drive (T27)
Head Diameter: 12mm
Stem Length: 14mm
Fits into 6mm Hole
Peugeot, Citroen, Renault & Dacia

UNIT PACKAGE: 25



21875

(Peugeot & Citroen: 6555.LE;
Renault & Dacia: 77-03-072-236)
Black Nylon

Push-Type Retainer
Torx® Drive (T27)
Head Diameter: 12.5mm
Stem Length: 9mm
Fits into 6mm Hole
Peugeot, Citroen, Renault & Dacia

UNIT PACKAGE: 25

RENAULT & DACIA, SAAB, AND SUBARU CLIPS & FASTENERS



21935

(77-03-072-361)
Black Nylon

Push-Type Retainer
Head Diameter: 12mm
Stem Length: 10mm
Fits into 6mm Hole
Renault & Dacia

UNIT PACKAGE: 15



13216

Zinc

U-Type Nut
Screw Size: 4.8mm
Panel Range: .9mm-2mm
Center of Hole to Edge: 8mm

UNIT PACKAGE: 25

SAAB



21927

(77-01-030-060)
White Nylon

Door Lock Rod Clip
Use on Right-Hand Side
Rod Size: 4mm
Renault & Dacia

UNIT PACKAGE: 15



21540

(GM: 24449408)
Orange Nylon

**Bumper, Grille, Wheel Apron & Lights
Nylon Extruded U-Nut**
Screw Size: M5.5 (#12)
Panel Range: Up to 2mm
Center of Hole to Edge: 12mm
Use with Auveco 21541
Buick Lacrosse & Regal 2011 - On
Saab 9-3 & 9-5 2003 - On
Saturn Astra 2009 - 08

UNIT PACKAGE: 25



21926

(77-01-030-060)
Yellow Nylon

Door Lock Rod Clip
Use on Left-Hand Side
Rod Size: 4mm
Renault & Dacia

UNIT PACKAGE: 15

SUBARU CLIPS & FASTENERS



22042

(57160FC010)
White Nylon

**Upper Front Bumper
Extension Moulding Clip**
Top Head Size: 9mm x 11mm
Bottom Head Size: 14mm x 17mm
Stem Length: 11mm
Forester 2005 - 1998

UNIT PACKAGE: 25



21564

(91059FC110)
White Nylon

Moulding Clip with Sealer
Head Size: 21.5mm x 24mm
Stem Diameter: 14.5mm
Stem Length: 17mm
Forester 2002 - 01

UNIT PACKAGE: 25



21581

(91059FC030)
White Nylon

**Front & Rear Door Fender,
Quarter Panel and Lift Gate
Moulding Clip with Sealer**
Top Head Size: 11mm x 14mm
Bottom Head Diameter: 17mm
Stem Length: 12mm
Fits into 9mm Hole
B9 Tribeca, Forester, Impreza
& Outback 1998 - On

UNIT PACKAGE: 25



21572

(91059FC090)
Black Nylon

Grille Clip
Top Head Size: 15.5mm x 11mm
Bottom Head Size: 19.5mm x 14mm
Stem Length: 11mm
Forester & Legacy 2008 - 1991

UNIT PACKAGE: 25



22050
(91059FC041)
Gray Nylon

Moulding Clip
Top Head Size: 11mm x 15mm
Bottom Head Size: 14mm x 22.5mm
Stem Length: 13mm
Overall Height: 24mm
Forester 2005 - 1998

UNIT PACKAGE: 25



21562
(91017FA080)
Gray Nylon

Grille Clip
Overall Height: 27mm
Forester Impreza & SVX 2008 - 1993

UNIT PACKAGE: 25

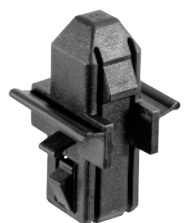

24203
(91017AA010)
Black Nylon

Radiator Grille Retainer
Hole Size: 9mm
Overall Length: 27mm
Subaru Forester, Legacy,
Outback 1990 - 2005

UNIT PACKAGE: 25



22907
(Subaru: 91048XA00A)
Black Nylon

Roof Moulding Clip
Width: 21mm
Length: 44mm
Subaru Impreza 2017 - On, Legacy 2010 - On
Outback & Tribeca 2014 - 2007

UNIT PACKAGE: 10



22816
(Subaru: 91012AG240)
White Nylon

Front & Rear Door Moulding Clip
Head Size: 10mm x 20mm
Stem Diameter: 8.8mm x 11.6mm
Stem Length: 12mm
Overall Height 13.5mm
Subaru Legacy & Outback 2009 - 2005

UNIT PACKAGE: 50



21579
(91167AA000)
Black Nylon

Cowl Top, Quarter Glass, Exterior Trim, Belt Moulding, Trunk Lid & Rear Light Grommet with Sealer
Head Diameter: 17.5mm
Stem Length: 15mm
Fits into 8mm Hole
Baja, Forester, Impreza, Legacy,
Outback & SVX 2006 - 1991

UNIT PACKAGE: 25



25196
(Subaru: 791017900)
White Nylon

Window & Door Moulding Grommet with Sealer
Head Diameter: 15mm
Stem Length: 8.5mm
Overall Height: 11mm
Fits into 8mm Hole

Subaru Impreza 2001 - 1993, Justy 1990 - 1994,
Legacy 1995 - On, Outback 2020 - On

UNIT PACKAGE: 25



21587
(62731FA010)
Blue Nylon

Screw Size: M3.5 (#6)
Head Size: 11mm x 11mm
Stem Length: 10mm
Fits into 8mm x 8mm Square Hole
Subaru 1993 - On

UNIT PACKAGE: 25



21629
(62731FA000)
White Nylon

Screw Size: M3.5 (#6)
Head Size: 10mm x 10mm
Stem Length: 5mm
Fits into 7mm x 7mm Hole
Forester, Impreza, Legacy &
Outback 2009 - 05

UNIT PACKAGE: 25



22044
(661179000, 909300007)
Yellow Nylon

Nylon Nut
Screw Size: M4.8 (#10)
Head Size: 14mm x 14mm
Stem Length: 7mm
Forester, Impreza, Justy, Legacy,
Outback, SVX, Tribeca & XV 1987 - On

UNIT PACKAGE: 25



21575
(94081FA010)
White Nylon

Screw Grommet
Screw Size: M4.8 (#10)
Head Diameter: 13mm
Stem Length: 8mm
Fits into 8mm Square Hole
Subaru 1992 - On

UNIT PACKAGE: 25



21569
(909300015)
White Nylon

Rear Bumper Screw Grommet
Screw Size: M4.8 (#10)
Head Diameter: 12mm
Stem Length: 15mm
Fits into 7mm Square Hole
Impreza, Legacy, Outback & SVX 2009 - 1995

UNIT PACKAGE: 25



22043
(91084AA010)
White Nylon

Screw Grommet with Sealer
Screw Size: M5.5 (#12)
Head Diameter: 20mm
Stem Length: 18mm
Forester, Impreza, Legacy,
Outback & Tribeca 1995 - On
UNIT PACKAGE: 15



21590
(91486KJ000)
White Nylon

Cowl & Dash Grommet
Head Diameter: 14mm
Stem Length: 7mm
Fits into 7mm Hole
Use with Auveco 21531
Forester, Impreza, Legacy & Outback 2008 - On
UNIT PACKAGE: 25



25118
(Subaru: 91486FL020)

Gray Nylon Cowl Grille Grommet
Head Diameter: 16mm
Stem Length: 7.3mm
Overall Height: 10.5mm
Fits into 7mm Hole
Use with Auveco No. 21531
Subaru Ascent 2019 - On, Forester 2009 - On,
BRZ, Crosstrek 2020 - 2013, Impreza 2008 - On,
Legacy, Outback 2010 - On, STI, WRX 2008 - On
UNIT PACKAGE: 25



21531
(91486KJ010)
Black Nylon

Cowl Panel Vent Cap
Top Head Size: 16mm x 18mm
Bottom Head Diameter: 14mm
Stem Length: 12mm
Use with Auveco 21590
Forester, Impreza, Legacy, Outback
& WRX 2008 - On
UNIT PACKAGE: 15



21573
(90331GA090)
Black Nylon

Weatherstrip Retaining Clip
Head Diameter: 9mm
Stem Diameter: 6.5mm
Stem Length: 13mm
Forester & Legacy 2008 - 1990
UNIT PACKAGE: 25



22046
(91167FA010)
Black Nylon

Front Hood Cowl Retaining Clip
Head Size: 9.3mm x 14.5mm
Stem Diameter: 7mm
Stem Length: 16mm
Impreza 2001 - 1993
UNIT PACKAGE: 25



22705
(Subaru: 909130162)
Dark Gray Nylon

Interior Foot Rest Pad Retainer
Head Diameter: 16mm
Stem Diameter: 7.7mm x 7.7mm
Stem Length: 30mm
Fits into 8mm Hole
Subaru BRZ, Crosstrek, Forester,
Impreza, Legacy, Outback,
Tribeca & WRX 2006 - On

UNIT PACKAGE: 25



21589
(99045AE03AMA)
Black Nylon

Trim Panel Retainer
Head Diameter: 18mm
Stem Diameter: 7.7mm
Stem Length: 15mm
B9 Tribeca, Impreza, Legacy
& Outback 2005 - On

UNIT PACKAGE: 25



22211
(909207031)
Black Nylon

Hood Insulation Retainer
Head Diameter: 23mm
Stem Diameter: 8mm
Stem Length: 15mm
Subaru BRZ, Forester, Impreza,
WRX & XV Crosstrek 2012 - On

UNIT PACKAGE: 50



21630
(95022AC040ML)
Black Nylon

Headliner & Trim Space Retainer
Head Diameter: 20mm
Stem Diameter: 6mm
Stem Length: 22mm
Forester, Impreza, Legacy
& Outback 1998 - On

UNIT PACKAGE: 25



21322
(90814FC001)
Black Nylon

Retainer
Head Diameter: 30mm
Stem Diameter: 6.5mm
Stem Length: 13mm
Subaru 1998 - On

UNIT PACKAGE: 10



21421

(909130074)
Black Nylon

Hood Insulation Retainer
Head Diameter: 30mm
Stem Diameter: 7.7mm
Stem Length: 13mm
Baja, Forester, Impreza,
Legacy, Outback & Tribeca 1998 - On

UNIT PACKAGE: 15



22290

(909130118)
Black Nylon

Moulding Retainer with Sealer
Head Diameter: 24mm
Stem Length: 16mm
Overall Length: 19.3mm
Subaru Impreza, Legacy &
Outback 2005 - On

UNIT PACKAGE: 15



22429

(Subaru: 99045SG000)
Green Nylon

**Front Fender
Moulding Clip with Sealer**
Top Head Size: 8mm x 12mm
Bottom Head Diameter: 14mm
Stem Diameter: 11.3mm
Stem Length: 16mm
Subaru Forester 2014 - On

UNIT PACKAGE: 15



21591

(909130109)
Black Nylon

**Front & Rear Door, Fender, Quarter Panel
and Rocker Panel Moulding Retainer**
Top Head Size: 11mm x 14mm
Bottom Head Diameter: 17mm
Stem Diameter: 9.7mm
Stem Length: 12mm
B9 Tribeca, Forester, Impreza,
Legacy & Outback 2003 - On

UNIT PACKAGE: 25



22207

(909130088)
Black Nylon

**Fender, Rocker, Garnish, Pillar, Floor
& Exterior Trim Retainer with Sealer**
Top Head Size: 11mm x 14mm
Bottom Head Diameter: 17mm
Stem Diameter: 9.7mm
Stem Length: 12mm
Subaru Forester, Impreza, Legacy, Outback,
B9 Tribeca & WRX 2005 - On

UNIT PACKAGE: 25



21567

(909130007)
Gray Nylon

**Pillar & Door Moulding Trim
and Rear Light Retainer with Sealer**
Top Head Size: 11mm x 15mm
Bottom Head Diameter: 18mm
Stem Diameter: 9.7mm
Stem Length: 12mm
B9 Tribeca, Forester, Impreza,
Legacy & Outback 2005 - On

UNIT PACKAGE: 25



22364

(Subaru: 94044TA040)
Gray Nylon

Door Panel Retainer
Top Head Diameter: 13mm
Middle Head Diameter: 16mm
Bottom Head Diameter: 18mm
Stem Diameter: 9mm
Stem Length: 13mm
Overall Length: 20mm
Subaru Impreza, Legacy,
Outback & STI 2016 - 2007

UNIT PACKAGE: 25



21574

(909130034)
White Nylon

**Door, Pillar, Rocker, Floor &
Interior Trim Retainer**
Top Head Diameter: 13mm
Middle Head Diameter: 16mm
Bottom Head Diameter: 15mm
Stem Diameter: 9.5mm
Stem Length: 11mm
Overall Length: 10mm
Baja, Forester, Legacy & Outback 2008 - 03

UNIT PACKAGE: 25



22343

(909130096)
Green Nylon

**Cowl, Garnish, Headliner, Rocker,
Pillar & Interior Trim Retainer**
Top Head Diameter: 13mm
Middle Head Diameter: 16mm
Bottom Head Diameter: 15mm
Stem Diameter: 9.8mm
Stem Length: 10mm

Subaru B9 Tribeca, BRZ, Forester, Impreza, Legacy,
Outback, WRX & XV Crosstrek 2005 - On

UNIT PACKAGE: 25



21502

(909130213)
White Nylon

Door Trim Panel Retainer with Sealer
Top Head Diameter: 13mm
Middle Head Diameter: 16mm
Bottom Head Diameter: 15mm
Stem Diameter: 9.5mm
Stem Length: 14mm
Overall Length: 20.5mm
Legacy & Outback 2010 - On

UNIT PACKAGE: 10



22206
(909130105)
White Nylon

Front & Rear Door, Headliner, Interior Trim, Liftgate & Quarter Panel Retainer

Top Head Diameter: 13mm
Middle Head Diameter: 16mm
Bottom Head Diameter: 15mm
Stem Diameter: 9.6mm x 9.6mm
Stem Length: 14mm
Overall Length: 21mm

Subaru BRZ, Forester, Impreza, Legacy, Outback, B9 Tribeca, WRX & XV Crosstrek 2002 - On

UNIT PACKAGE: 50



21584
(693005370)
White Nylon

Front Door & Lift Gate Trim Panel Retainer

Top Head Diameter: 13mm
Middle Head Diameter: 16mm
Bottom Head Diameter: 18mm
Stem Diameter: 9.3mm
Stem Length: 10mm
Overall Length: 10mm

Impreza, Justy, Legacy & Outback 2007 - 1987

UNIT PACKAGE: 25



22048
(94078FA080)
White Nylon

Trim Panel Retainer

Top Head Diameter: 13mm
Middle Head Diameter: 16mm
Bottom Head Diameter: 18mm
Stem Diameter: 9mm x 9.5mm
Stem Length: 11mm
Overall Length: 16.5mm

Forester, Impreza & XV Crosstrek 1994 - On

UNIT PACKAGE: 25



21565
(90331AA050)
White Nylon

Weatherstrip Retaining Clip

Head Size: 5mm x 14mm
Stem Diameter: 7mm
Stem Length: 8.5mm
Forester 2008 - 03

UNIT PACKAGE: 25



21585
(909130003)
Black Nylon

Upper Grille Push-Type Retainer

Head Diameter: 9mm
Stem Length: 7mm
Fits into 4mm Hole
Baja, Legacy & Outback 2006 - 2000

UNIT PACKAGE: 25



22230
(909140059)
Black Nylon

Front & Rear Bumper Push-Type Retainer

Head Diameter: 10mm
Stem Length: 8.5mm
Fits into 5mm Hole

Subaru Forester, Impreza, Legacy, Outback, WRX, XV Crosstrek 2008 - On

UNIT PACKAGE: 15



21593
(46064AE000)
Black Nylon

Front Fender Bumper & Quarter Panel Push-Type Retainer

Head Diameter: 15mm
Stem Length: 8mm
Fits into 7mm Hole

Baja, Forester, Impreza, Legacy & Outback 2003 - On

UNIT PACKAGE: 10



22160
(909140062)
Black Nylon

Front & Rear Bumper Push-Type Retainer

Head Diameter: 15mm
Stem Length: 10mm
Fits into 7mm Hole

Subaru BRZ, Forester, Impreza & XV Crosstrek 2008 - On

UNIT PACKAGE: 15



21658
(Mitsubishi: MR288150;
Subaru: 909130013)
Black Nylon

Push-Type Retainer

Head Diameter: 15mm
Stem Length: 11mm
Fits into 6mm Hole

Mitsubishi Endeavor, Galant, Lancer, Mirage, Montero & Outlander 1997 - On
Subaru BRZ, Forester, Impreza, Legacy, Outback, & XV Crosstrek 2004 - On

UNIT PACKAGE: 10



21570
(909140012)
Black Nylon

Rear Light Reflector & Roof Spoiler Push-Type Retainer

Head Diameter: 16mm
Stem Length: 11mm
Fits into 6mm Hole

B9 Tribeca, Impreza, Legacy & Outback 2005 - On

UNIT PACKAGE: 25



21566
(91085TA030)
Black Nylon

Push-Type Retainer
Head Diameter: 16mm
Stem Length: 13mm
Fits into 7mm Hole

Baja, Impreza, Legacy & Outback 2000 - On

UNIT PACKAGE: 25



21530
(Subaru: 909130067;
Hyundai: 86590-3S000)
Black Nylon

**Engine Cover and Fender Liner
Push-Type Retainer**

Head Diameter: 18mm
Stem Length: 10mm
Fits into 8mm Hole

B9 Tribeca, Forester, Legacy &
Outback & Tribeca. 2005 - On
Hyundai Azera, Elantra, Genesis & Sonata
and Kia Cadenza & Optima 2011 - On

UNIT PACKAGE: 15



22595
(Hyundai: 86590-1W000)
Black Nylon

**Bumper Cover
Push-Type Retainer**

Head Diameter: 18mm
Stem Length: 11mm
Fits Into 8mm Hole

Hyundai Equus & Genesis 2016 - 2014
Kia Rio & Sedona 2012 - On

UNIT PACKAGE: 25



22181
(909140065)
Black Nylon

**Front Fender Liner, Engine Cover,
Hood & Quarter Panel Push-Type Retainer**

Head Diameter: 18mm
Stem Length: 10mm
Fits into 8mm Hole

Subaru BRZ, Crosstrek, Forester, Impreza,
Legacy, Outback & WRX 2008 - On

UNIT PACKAGE: 15



21422
(909140051)
Black Nylon

**Front Bumper & Quarter Panel
Push-Type Retainer**

Head Diameter: 20mm
Stem Length: 9mm Excluding Pin
Fits into 7mm Hole

B9 Tribeca, Impreza, Legacy & Outback 2005 - On

UNIT PACKAGE: 15



21571
(59122FA010)
Black Nylon

**Front Bumper, Fender, Windshield Washer
& Rocker Moulding Push-Type Retainer**

Head Diameter: 20mm
Stem Length: 10mm

Fits into 8mm Hole
B9 Tribeca, Baja, Forester,
Impreza, Legacy & Outback 1998 - On

UNIT PACKAGE: 25



22270
(909140068)
Black Nylon

Front Fender Push-Type Retainer

Head Diameter: 20mm
Stem Length: 10mm

Fits into 8mm Hole
Subaru BRZ, Impreza, Legacy,
Outback & XV Crosstrek 2012 - On

UNIT PACKAGE: 15



21592
(909140052)
Black Nylon

Push-Type Retainer

Head Diameter: 20mm
Stem Length: 11mm
Fits into 7mm Hole

B9 Tribeca, Impreza, Legacy
& Outback 2005 - On

UNIT PACKAGE: 15



21594
(909130051)
Black Nylon

**Fender Liner, Duct &
Lower Moulding Push-Type Retainer**

Head Diameter: 20mm
Stem Length: 11mm

Fits into 7mm Hole
B9 Tribeca, Forester, Impreza,
Legacy & Outback 2005 - On

UNIT PACKAGE: 15



21580
(59122AC030)
Black Nylon

Front Fender Push-Type Retainer

Head Diameter: 20mm
Stem Length: 12mm
Fits into 7mm Hole

B9 Tribeca, Baja, Forester,
Legacy & Outback 1995 - On

UNIT PACKAGE: 25



21500
(909140063)
Black Nylon

Cowl Vent Push-Type Retainer

Head Diameter: 20mm
Stem Length: 12mm

Fits into 7mm Hole
Legacy & Outback 2010 - On

UNIT PACKAGE: 10



21563

(909130059)
Black Nylon

**Front Bumper & Fender
Push-Type Retainer**

Head Diameter: 20mm
Stem Length: 15mm
Fits into 10mm Hole

Forester, Impreza, & Outback 2006 - 02

UNIT PACKAGE: 25



22047

(94415FA000NE)
Gray & Black Nylon

**Rear Roof Spoiler Trim
Push-Type Retainer**

Top Head Diameter: 25mm
Bottom Head Diameter: 21mm
Stem Length: 9mm (Excluding the Pin)
Fits into 8mm Hole
Impreza 2007 - 1998

UNIT PACKAGE: 15



21420

(909140007)
Black Nylon

**Bumper, Engine Cover, Fender
& Grille Push-Type Retainer**

Head Diameter: 21mm
Stem Length: 15mm Excluding Pin
Fits into 10mm

B9 Tribeca, Baja, Forester, Impreza,
Legacy & Outback 2000 - On

UNIT PACKAGE: 15



21568

(57160FC000)
Black Nylon

**Front Fender
Push-Type Retainer**

Top Head Length: 19.5mm
Bottom Head Diameter: 14mm
Stem Length: 15mm
Fits into 10mm Hole
Forester 2008 - 1998

UNIT PACKAGE: 25



21578

(57750AA090)
Black Nylon

**Front & Rear Bumper
Push-Type Retainer**

Head Diameter: 22mm
Stem Length: 28mm
Fits into 10mm Hole

Impreza & Legacy 2001 - 1993

UNIT PACKAGE: 25



22210

(57371GA070)
Natural Nylon

Tube/Cable Routing Clip

Holds 5mm Diameter Tube/Cable
Snaps into 6mm Hole
Overall Height: 15mm
Subaru BRZ, Forester, Impreza, Legacy,
Outback, B9 Tribeca & WRX 1995 - On

UNIT PACKAGE: 25



21501

(909140055)
Black Nylon

Push-Type Retainer with Sealer

Head Diameter: 25mm
Shoulder Length: 3mm
Shoulder Diameter: 16.5mm
Stem Length: 12mm Excluding Pin
Fits into 11mm Hole
Subaru 2006 - On

UNIT PACKAGE: 5



22706

(Subaru: 909205056)
Black Nylon

Trunk Release Cable Clip

Holds 5mm Dia. Tube/Cable
Fits into 10mm Hole
Overall Height: 20mm
Subaru Crosstrek, Impreza
& Legacy 2012 - On

UNIT PACKAGE: 25



21576

(909140002)
Black Nylon

**Rocker, Pillar, Floor & Exterior Trim
Push-Type Retainer with Sealer**

Head Diameter: 25mm
Shoulder Diameter: 17mm
Shoulder Length: 3mm
Stem Length: 16mm Excluding Pin
Fits into 11mm Hole

B9 Tribeca, Baja, Legacy & Outback 2000 - On

UNIT PACKAGE: 25



22175

(91086AA000)
Black Nylon

**Splash Guard Nylon U-Nut
with Metal Insert Nut**

Thread: M5-.80
(Internal Steel Nut)
Panel Range: Up to 3mm
Center of Hole to Edge: 10mm
Subaru 2008 - On

UNIT PACKAGE: 10



22078
(83942-65D00)
White Nylon

Liftgate, Exterior Trim & Garnish Moulding Clip
Top Head Size: 9mm x 10mm
Middle Head Diameter: 12mm
Bottom Head Diameter: 15mm
Stem Length: 11mm
Fits into 9mm Hole
Suzuki Grand Vitara & XL7 2006 - 1999

UNIT PACKAGE: 25



20743
(77553-65D00)
White Nylon

Moulding Clip
Head Diameter: 18mm
Stem Length: 9mm
Overall Length: 18mm
Suzuki

UNIT PACKAGE: 10



22079
(77553-65D10)
White Nylon

Moulding Clip
Head Diameter: 18mm
Stem Length: 9mm
Overall Height: 18mm
Suzuki Grand Vitara,
Swift & XL7 1990 - On

UNIT PACKAGE: 15



20744
(77259-71B00)
White Nylon

Moulding Clip with Sealer
Top Head Diameter: 13mm
Bottom Head Diameter: 16mm
Stem Length: 13mm
Suzuki

UNIT PACKAGE: 10



23961
(96057293, 83943-86000)
Nylon

Cowl Vent Retainer
Head Size: 12mm x 15mm
Fits in 7mm Hole
Geo Tracker 1999 - On
Suzuki Vitara 1999 - On

UNIT PACKAGE: 25



23962
(30000784, 09409-05309-5ES)
Nylon

Cowl Vent Retainer
Head Diameter: 14mm
Stem Diameter: 6mm
Stem Length: 15mm
Geo Tracker 1999 - On
Suzuki Vitara 1999 - On

UNIT PACKAGE: 25



17383
(GM: 94847334, 96057847;
Toyota: 90467-07066;
Suzuki: 09409-07313)
Black Nylon

Radiator Grille & Trim Panel Push-Type Retainer
Head Diameter: 11mm
Stem Length: 14mm (Excluding the Pin)
Fits into 7mm Hole
Suzuki and Geo Tracker & Prizm 1992 - 89

UNIT PACKAGE: 10



22083
(09409-08327)
Black Nylon

Front Lights, Cowl & Rear Bumper Push-Type Retainer
Head Diameter: 16mm
Stem Length: 10mm
Fits into 8mm Hole
Suzuki Kizashi, SX4 & XL7 2013 - 2002

UNIT PACKAGE: 15



20908
(Suzuki: 09409-07332;
Toyota: 90467-07164)
Black Nylon

Fender Splash Sheild Push-Type Retainer
Head Diameter: 20mm
Stem Length: 10mm
Fits into 7mm Hole
Suzuki 1999 - On
Toyota 1997 - On

UNIT PACKAGE: 10



21745
(GM: 11609651)
Zinc

Windshield Garnish and Interior Trim Moulding Fastener
Screw Size: M4.2 (#8)
Stem Width: 13mm
Head Size: 13.5mm x 20.5mm
Overall Length: 22mm
Buick Enclave & Encore; Cadillac CTS, Escalade, STS & XTS; Chevrolet Avalanche, Camaro, Cobalt, Corvette, HHR, Impala, Malibu, Monte Carlo, Silverado, Suburban, Tahoe & Traverse; Dodge Truck; Ford Flex & Taurus; GMC Sierra & Yukon; Kia Sorento & Soul; Pontiac G6 & G8; Saturn Outlook and Suzuki Grand Vitara 2004 - On

UNIT PACKAGE: 15

23828
(81195-89101)

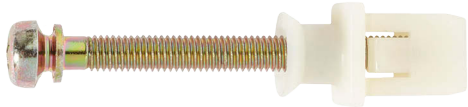

Headlamp Adjusting Screw Assembly
Screw Size: M5 x 50mm
Nylon Nut: M5
Toyota Pick-Up 1984 - On
UNIT PACKAGE: 15



16951
(81124-89101)
Nylon

Headlight Spacer
Width: 15mm
Length: 18mm
Fits into 7mm Square Hole
Pick-Up Truck 1984-On
UNIT PACKAGE: 25



20738
(53271-44010)
Black Nylon

Headlight Bracket Clip
Width: 25mm
Length: 40.5mm
Toyota Camry & RAV4
and Lexus IS-300 2001 - On
UNIT PACKAGE: 4



22102
(53271-12040;
53271-12060; 53271-0B010)
Black Nylon

Headlight Bracket Clip
Width: 25mm
Length: 39mm
Overall Height: 33mm
Lexus GX460, GX470, RX 300, RX 330 & RX 350 and
Toyota Corolla, Echo, Highlander, MR2, Prius, Tacoma,
Tercel & 4-Runner 1993 - On
UNIT PACKAGE: 10



21369
(67771-58010)
White Nylon

Door & Garnish Moulding Clip
Overall Height: 12.4mm (1/2")
Tundra 2007 - On
UNIT PACKAGE: 25



21546
(90467-09204)
White Nylon

**Rear Hatch Door Side Garnish
and Front Body Pillar Garnish
Moulding Clip**
Overall Height: 14mm
Toyota Camry, Highlander, Prius & Sienna and
Lexus GS 300, GS 400, GS 430, GX 470, RX 330,
RX 350, RX 400 & RX 450 1998 - On
UNIT PACKAGE: 25



21549
(90467-12080)
Pink Nylon

**Door Trim, Instrument Panel,
Rear Deck Trim & Roof Garnish Trim
Moulding Clip**
Overall Height: 21mm

Toyota Avalon, Camry, Corolla, Echo, FJ Cruiser,
Highlander, Matrix, Prius, RAV4, Sequoia, Sienna,
Tacoma, Tundra, Venza, Yaris & 4-Runner and
Lexus ES 350, GX 460, RX 330 & RX 450h 2000 - On

UNIT PACKAGE: 25



17194
(90467-13005)
Black Nylon

Grille Clip
Width: 13mm
Length: 23mm

UNIT PACKAGE: 25



23818
(90467-12020, H200-S0-715
BF67-S0715)
Gray Nylon

Grille & Headlamp Door Clip
Toyota Corolla 1983 - On
Chevrolet Nova 1986 - On
Mazda 323 1986 - On
Ford Festiva & Tracer 1988 - On

UNIT PACKAGE: 25



21623
(Mitsubishi: MR221507;
Toyota: 90467-13075)
Gray Nylon

Radiator Grille Clip
Width: 14mm
Length: 24mm
Mitsubishi Diamante, Endeavor & Galant 1997 - On
Toyota 4 Runner, Highlander & Land Cruiser 1998 - On

UNIT PACKAGE: 25



17438
(90467-17004)
Black Nylon

Radiator Grille Clip
Width: 21mm
Length: 22mm
Cressida 1987-84

UNIT PACKAGE: 10



22163
(53145-12010)
Black Nylon

Grille Clip
Overall Length: 38mm
Toyota Corolla, FJ Cruiser
& Tacoma 1993 - On

UNIT PACKAGE: 15



21194
(61118-35010)
Black Nylon

**Front Fender Upper Seal
Moulding Clip**
Head Size: 18mm x 18mm
Stem Length: 13mm
Fits into 9mm Hole
FJ Cruiser 2007 - On

UNIT PACKAGE: 15



22351
(90467-10181)
Black Nylon

Headliner & Interior Trim Moulding Clip
Top Head Size: 18mm x 19mm
Bottom Head Size: 18mm x 24mm
Stem Diameter: 10mm
Stem Length: 13mm
Lexus ES 300h/350,
GS 300/350/430/460,
IS 200T/250/300/350, NX 200T/300h,
RC 200T/300/350 & RX 350/400h/450h and
Toyota Avalon & Camry 1998 - On

UNIT PACKAGE: 25



22346
(53857-12010)
Black Nylon

Front Fender Moulding Clip with Sealer
Head Size: 20mm x 30mm
Stem Diameter: 9mm
Stem Length: 10mm
Lexus NX 200t, NX 300h, Scion iM and
Toyota Corolla & Prius 2015 - On

UNIT PACKAGE: 15



15695
(Toyota: 62955-20020, 65955-12010;
GM: 94848834)
White Nylon

Moulding Clip with Sealer
Head Diameter: 15mm
Stem Length: 9mm
Fits into 8mm Hole
Toyota Pick-Up Truck and Pontiac Vibe

UNIT PACKAGE: 25



22488
(Toyota: 81496-52020, 81496-0E020)
Natural Nylon

**Rear Combination Tail Light
Guide Grommet with Sealer**
Head Diameter: 16mm
Stem Length: 14mm
Overall Length: 15mm
Lexus CT 200h, ES 300h, ES 350, GX 460, IS
200t, IS 250, IS 300, IS 350, LC 500h, LX 570,
NX 200t, NX 300h, RC F, RC 200h,
RC 300, RC 350, RX 350 & RX 450h
and Toyota 4Runner, C-HR, Corolla, Corolla
iM, Highlander, Land Cruiser,
Mirai, Prius, Prius Prime, Prius V, RAV4,
Sequoia, Venza & Yaris 2006 - On
Scion iM & xD 2016 - 2008

UNIT PACKAGE: 25



22398
(Toyota: 81496-60010)
White Nylon

**Rear Combination Lamp Guide
Moulding Clip with Sealer**
Top Head Diameter: 13mm
Bottom Head Diameter: 20mm
Stem Length: 10.5mm
Lexus CT 200h, ES 300h, ES 350,
GX 470, IS F, IS 250, NX 200t, NX 300h,
RC F, RC 350, RX 330, RX 350, RX 400h
& RX 450h and Toyota 4Runner, Avalon, Camry,
Camry Hybrid, Corolla, Matrix, Prius, Prius C, RAV4,
Sienna, Venza & Yaris 2006 - On
Scion iQ & iQ EV 2014 - 2011

UNIT PACKAGE: 25



21748
(75819-33010)
White Nylon

Moulding Clip with Sealer
Top Head Size: 8mm x 8mm
Bottom Head Diameter: 15mm
Stem Diameter: 10mm
Stem Length: 14mm
Lexus ES300 & ES330 & Scion and Toyota Camry,
Corolla, Prius, Sequoia, Sienna & Tundra 2002 - On

UNIT PACKAGE: 25



21453
(75395-0T010)
White Nylon

Moulding Clip with Sealer
Top Head Size: 5mm x 10mm
Bottom Head Diameter: 18mm
Stem Diameter: 10mm
Stem Length: 13mm
Corolla & Venza 2008 - On

UNIT PACKAGE: 25



21653
(75867-AC020)
White Nylon

Moulding Clip with Sealer
Head Diameter: 18mm
Stem Length: 13mm
Fits into 8mm Hole
Avalon 2005 - On

UNIT PACKAGE: 15



19797
(90467-10077)
Butterscotch Nylon

Door Moulding Clip with Sealer
Head Diameter: 15mm
Stem Length: 9mm
Fits into 8mm Hole
Avalon & Corolla 1998 - On

UNIT PACKAGE: 15



22456
(Toyota: 62955-50010)
Yellow Nylon

Rocker & Quarter Vent Moulding Clip with Sealer
Top Head Size: 8mm x 8mm
Bottom Head Diameter: 15mm
Stem Diameter: 8mm x 8mm
Stem Length: 11mm
Lexus ES 250, HS 250h, LS 460, LS 600h L, RX 350 & RX 450h and Toyota Highlander, RAV4 & Yaris 2013 - On

UNIT PACKAGE: 25



22217
(90467-08225)
White Nylon

Moulding Clip with Sealer
Top Head Size: 10mm x 10mm
Bottom Head Diameter: 15mm
Stem Diameter: 8mm x 8mm
Stem Length: 8mm
Toyota Corolla, Highlander & RAV4 2014 - On

UNIT PACKAGE: 25



22454
(Toyota: 76817-68010)
Yellow Nylon

Door Garnish Clip with Sealer
Top Head Size: 10mm x 10mm
Bottom Head Diameter: 16mm
Stem Diameter: 9.5mm x 9.5mm
Stem Length: 15mm
Lexus LX 570 and Toyota Land Cruiser & RAV4 2013 - On

UNIT PACKAGE: 25



22396
(Lexus: 90467-08224)
White Nylon

Body Side & Wheel Opening Moulding Clip
Top Head Size: 10mm x 10.5mm
Bottom Head Diameter: 15mm
Stem Diameter: 8mm x 8mm
Stem Length: 8mm
Lexus NX 200t, NX 300h, RX 350 & RX 450h 2015 - On

UNIT PACKAGE: 25



21550
(90467-11099)
White Nylon

Hood and Front & Rear Side Moulding Clip
Head Diameter: 17mm
Stem Length: 8.5mm
Fits into 9mm Square Hole
Tundra & 4-Runner 2006 - 1996

UNIT PACKAGE: 25



20687
(75396-35020, 75495-35010)
Blue Nylon

Rocker Moulding Clip with Sealer
Head Diameter: 17mm
Stem Length: 10mm
4-Runner 2003 - On

UNIT PACKAGE: 10



17481
(90467-11063)
White Nylon

Rocker Panel Moulding Clip with Sealer

Head Diameter: 18mm
Stem Length: 9mm
Previa 1990-On

UNIT PACKAGE: 15



20390
(90904-67036)
Blue Nylon

Fender Moulding Clip
Head Diameter: 17mm
Stem Length: 17mm
Highlander, Land Cruiser, Tacoma & Tundra 2001 - On

UNIT PACKAGE: 10



20391
(90904-67037)
Red Nylon

Fender Moulding Clip
Head Diameter: 17mm
Stem Length: 13mm
Highlander, Land Cruiser, Tacoma & Tundra 2001 - On

UNIT PACKAGE: 10



20688
(75397-35010)
Orange Nylon

Wheel Flare Moulding Clip with Sealer
Head Diameter: 17mm
Stem Length: 17mm
4-Runner 2003 - On

UNIT PACKAGE: 10



20429
(90467-11100)
Yellow Nylon

Fender & Wheel Flare Moulding Clip
Head Diameter: 17mm
Stem Length: 17mm
Highlander, Land Cruiser, Tacoma & Tundra 2000 - On

UNIT PACKAGE: 10



21847
(90467-08195)
White Nylon

Front & Rear Fender Flare Moulding Clip with Sealer
Head Size: 15mm x 22mm
Stem Length: 13mm
Overall Length: 21mm
Lexus GX470 2009 - 03
Toyota Land Cruiser 2007 - 1998

UNIT PACKAGE: 25



21846
(90467-08196)
Yellow Nylon

Front & Rear Fender Flare and Mudguard Moulding Clip with Sealer
Head Size: 16mm x 22mm
Stem Length: 19mm
Overall Length: 27mm
Lexus GX470 2009 - 03
Toyota Land Cruiser 2007 - 1998

UNIT PACKAGE: 25



19843
(75498-42010)
White Nylon

Garnish Clip
Head Diameter: 20mm
Stem Length: 20mm
RAV4 1996 - On

UNIT PACKAGE: 10



22490
(Toyota: 90541-09124)
Rubber & Nylon

Rear Door Rubber Bumper
Rubber Diameter Top: 14mm
Rubber Diameter Bottom: 17mm
Overall Height: 16.5mm
Lexus CT 200h, HS 250h, IS 250 & IS 350
and Toyota Avalon, Camry, C-HR,
Corolla, Highlander Matrix, Prius,
Prius Prime & Yaris 2009 - On
Scion iQ & tC 2016 - 2009

UNIT PACKAGE: 25



22413
(Toyota: 90541-09069)
Rubber & Nylon

Front Door Rubber Bumper
Rubber Diameter Top: 15mm
Rubber Diameter Bottom: 17mm
Overall Height: 19.5mm
Toyota 4Runner, Corolla, Highlander,
Land Cruiser, Matrix, RAV4 &
Terrel 1999 - On

UNIT PACKAGE: 25



22350
(90467-A0004)
White Nylon

Headliner & Interior Trim Moulding Clip
Top Head Size: 14mm x 20mm
Bottom Head Size: 18mm x 24mm
Stem Diameter: 10mm
Stem Length: 14mm
Lexus RX 350 and Toyota
Avalon & Camry 2005 - On

UNIT PACKAGE: 25



22215
(75397-42010)
White Nylon

Moulding Clip with Sealer
Top Head Size: 14.5mm x 17mm
Bottom Head Size: 12mm x 18mm
Stem Length: 9mm
Toyota RAV4 2005 - 2001

UNIT PACKAGE: 25



22525

(Toyota: 75494-42010,
75395-42020)
Yellow Nylon

**Rocker Moulding Clip
with Sealer**

Top Head Size: 10.3mm x 16.5mm
Bottom Head Size: 13.5mm x 17.5mm
Stem Length: 19mm
Toyota FJ Cruiser & RAV4 2014 - 2001

UNIT PACKAGE: 25



21642

(90467-12075)
Yellow Nylon

Rocker Moulding Clip

Top Head Size: 11mm x 13mm
Bottom Head Size: 15mm x 25mm
Stem Length: 14mm
Fits into 10mm x 10mm Hole
Land Cruiser 2007 - 1998

UNIT PACKAGE: 15



20578

(GM: 88970495, 88973654;
Toyota: 76924-52021)
Black Nylon

Rocker Moulding Retainer

Head Diameter: 32mm
Stem Length: 10mm
Fits into 22mm Hole

Pontiac Vibe & Toyota Corolla 2003 - On

UNIT PACKAGE: 25



22569

(Toyota: 90467-22014)
Black Nylon

**Rocker Moulding
Retainer with Sealer**

Head Diameter: 38mm
Stem Length: 11mm
Fits into 22mm Hole
Toyota Camry 2018 - On
Prius & Prius Prime
2016 - On

UNIT PACKAGE: 10



22570

(Toyota: 90467-22015)
Black Nylon

**Rocker Moulding
Retainer with Sealer**

Head Diameter: 47mm
Stem Length: 35mm
Fits into 22mm Hole
Toyota Camry 2018 - On
Prius & Prius Prime
2016 - On

UNIT PACKAGE: 10



22457

(Toyota: 76924-13020)
Black Nylon

Rocker Moulding Retainer

Head Diameter: 25mm
Stem Length: 11mm
Fits into 14mm Hole
Toyota 4Runner &
Land Cruiser 2008 - On

UNIT PACKAGE: 25



21071

(90084-46020)
White Nylon

Bumper Cover Clip

Head Size: 21mm x 30mm
Stem Length: 12mm
Camry 2005 - On

UNIT PACKAGE: 10



21712

(52535-0E030)
White Nylon

Moulding Clip

Top Head Size: 13mm x 13mm
Stem Length: 22mm
Overall Length: 25mm
Lexus LS 600h & RX 450h
and Toyota RAV4 & 4Runner 2006 - On

UNIT PACKAGE: 15



21857
(75392-35220)
White Nylon

Front & Rear Spoiler Moulding Clip
Head Size: 10mm x 20mm
Stem Length: 24mm
Overall Length: 27mm
Lexus HS250 & RX350 and Toyota
Camry, Corolla, FJ Cruiser &
Highlander 2010 - On

UNIT PACKAGE: 25



21016
(75392-35200, 75392-04010)
Blue Nylon

Fender Flare & Bumper Clip
Head Size: 13mm x 26mm
Stem Length: 24mm
Toyota Camry, FJ,
RAV4 & Tacoma 2005 - On

UNIT PACKAGE: 15



21586
(76853-10010)
White Nylon

Front & Rear Bumper Clip
Head Size: 13mm x 26mm
Stem Length: 25mm
Matrix 2008 - 03

UNIT PACKAGE: 25



22158
(62217-33031)
Black Nylon

Windshield Pillar Trim Clip
Overall Length: 43mm
Stem Size: 7mm x 12mm
Stem Length: 12mm
Toyota Camry 2011 - 2007

UNIT PACKAGE: 15



22159
(90950-08004)
Black Nylon

**Roof Garnish &
Front Pillar Post Trim Clip**
Overall Length: 51mm
Stem Size: 7mm x 12mm
Stem Length: 12mm
Toyota Camry, Corolla, Highlander,
Land Cruiser, Matrix &
RAV4 2013 - 2004

UNIT PACKAGE: 15



21234
(61991-35010)
Black Nylon

**Front Fender/Sheet Metal
Upper Seal Moulding Clip**
Top Head Size: 9mm x 31mm
Overall Height: 30mm
FJ Cruiser 2007 - On

UNIT PACKAGE: 10



21235
(61992-35010)
Black Nylon

**Front Fender/Sheet Metal
Upper Seal Moulding Clip**
Top Head Size: 13mm x 31mm
Overall Height: 34mm
FJ Cruiser 2007 - On

UNIT PACKAGE: 10



21132
(52115-48040)
Gray Nylon

**Front Bumper
Moulding Clip**
Overall Length: 47mm
Stem Length: 8mm
Highlander 2001 - On

UNIT PACKAGE: 10



21217
(76924-47010)
Black Nylon

**Rocker Panel
Moulding Clip**
Head Size: 43mm x 54mm
Overall Height: 26mm
Prius 2009 - On

UNIT PACKAGE: 5



21221
(52115-0C090)
Black Nylon

Front Bumper Moulding Clip
Head Size: 25mm x 74mm
Overall Height: 17mm
Stem Length: 15mm
Tundra 2009 - On

UNIT PACKAGE: 10



21162
(53935-35020)
Black Nylon

Bumper Filler Clip
Overall Length: 30mm
Overall Height: 17mm
4 Runner 2003 - On

UNIT PACKAGE: 10



16800

Photo not actual size

M6-1.0 x 20mm
License Plate Hardware
Includes Nylon Screw,
Washer & Spacer and Brass Nut

UNIT PACKAGE: 25 Sets



17636
Nylon

**License Plate
Bracket Spacer**
Inner Diameter: 1/4" (6mm)
Outer Diameter: 3/4" (19mm)
Thickness: 1/4" (6mm)

UNIT PACKAGE: 50

19204
(75546-12060)
Natural Nylon



Windshield Moulding Clip
Corolla Sedan Wagon 1992-88

UNIT PACKAGE: 25



14746
(75546-12050)
Nylon

Windshield Moulding Clip
Width: 20mm
Length: 41mm
Fits into 8mm Hole

UNIT PACKAGE: 15

22427
(Toyota: 75548-60021)
White Nylon



**Rocker, Pillar, Exterior Trim &
Windshield Moulding Clip**
Width: 15.5mm
Length: 52mm
Lexus LX 570 & Toyota Land Cruiser 2008 - On

UNIT PACKAGE: 10



14751
(75545-16020)
Nylon

**Windshield
Moulding Clip**
Width: 18mm
Length: 49mm
Height: 13mm

UNIT PACKAGE: 25



16821
(75546-12030)
Nylon

**Windshield
Moulding Clip**
Width: 21mm
Length: 54mm
Height: 15mm
Corolla 1984-On

UNIT PACKAGE: 25



16942
(75545-89101)
Nylon

Windshield Moulding Clip
Width: 15mm
Length: 47mm
Height: 13mm
Pick-Up Truck 1984-On

UNIT PACKAGE: 15

25345

(Lexus, Scion & Toyota: 56115-30100)
Black Nylon



Windshield Moulding Clip

Width: 15mm
Length: 39mm

Overall Height: 10mm

Lexus CT200h 2017 - 2011, ES300, ES350 2018 - 2013,
GS300 2006 - 1998, GS400 2000 - 1998,
GS430, LS430 2006 - 2001, GX460 2021 - 2010,
GX470 2009 - 2003, HS250h 2012 - 2010,
LS460 2017 - 2007, LS600h 2016 - 2008,
LX570 2021 - 2008, NX200t 2017 - 2015,
NX300 2021 - 2015, UX200, UX250 2021 - 2019;
Toyota 4Runner 1999 - On, Camry 2006 - 1999,
Celica, Echo 2005 - 2000, C-HR 2017 - On,
Corolla 2003 - On, FJ Cruiser 2014 - 2007,
Highlander, Land Crusier 2020 - 2008,
Matrix 2013 - 2003, Prius 2010 - On,
RAV4 2021 - 2001, Sequoia 2010 - 2001,
Solara 2008 - 2006, Tacoma 2020 - 2005,
Tundra 2006 - 2000, Yaris 2018 - 2007;
Scion iQ 2015 - 2012, tC 2016 - 2005,
xA 2006 - 2004, xB 2015 - 2004, xD 2014-2008

UNIT PACKAGE: 25

25429

(Lexus & Toyota: 75545-30170, 75545-0E020)
White Nylon



Windshield Moulding Clip

Width: 15mm
Length: 58mm

Overall Thickness: 5mm

Lexus ES250 2021, ES300h 2013-2021, ES350 2013-On,
GS 2016-2020, GS200t, IS200t 2016, GS300 2018-2019,
GS350 2013-2020, GS450h 2013-2018, IS 2017,
RX350, RX450h 2021 - 2016; Toyota Avalon 2021 - 2019,
Camry 2021 - 2018, Highlander 2021 - 2014,
Mirai, Venza 2021, Prius 2021 - 2016, Sienna 2021

UNIT PACKAGE: 25



25413

(Toyota: 62217-42030)
Black Nylon

Windshield Pillar Trim Clip

Flange Width: 24mm
Overall Length: 48.5mm
Stem Diameter: 8mm
Stem Length: 12.5mm
Fits into 8.5mm Hole
Toyota RAV4 2014 - 2008

UNIT PACKAGE: 25



14271

(90189-04011)
Natural Nylon

Screw Size: #6
Width: 12mm
Length: 12mm

Snaps into 7mm x 7.5mm Hole

UNIT PACKAGE: 25



21628

(81137-22530, 90075-10004)
White Nylon

Screw Size: M3.5 (#6)
Head Size: 10mm x 10mm
Stem Length: 7mm

Fits into 7mm x 7mm Hole
Avalon, Camry, Land Cruiser,
Tacoma & Tundra 2007 - 1992

UNIT PACKAGE: 25



22051

(90467-11117)
White Nylon

Rear Trunk License Plate Trim Retaining Nut

Screw Size: M3.5 (#6)
Overall Height: 11.5mm
Width at Bottom: 11mm

Lexus & Toyota 2009 - 1998

UNIT PACKAGE: 15



14256

(90189-04014)
Natural Nylon

Screw Size: #8
Width: 10mm
Length: 10mm

Snaps into 7mm x 7mm Hole

UNIT PACKAGE: 50



13932

(Toyota: 90189-05013;
Mitsubishi: MS-480002)
Natural Nylon

Screw Size: #10
Width: 12mm
Length: 12mm

Fits into 8mm x 9mm Hole

UNIT PACKAGE: 50



14274

(Toyota: 90189-06010;
Honda: 75521-611-000;
Mazda: 9991-00-601;
Nissan: 96706-P0105)
Natural Nylon

Screw Size: #10
Width: 13mm
Length: 13mm

Snaps into 8.5mm x 8.5mm Hole

UNIT PACKAGE: 25



14258

(90189-06018)
Black Nylon

Screw Size: #10
Width: 14mm
Length: 14mm
Snaps into 9mm x 9mm Hole

UNIT PACKAGE: 25



20895

(90189-06193)
Natural Nylon

Front Bumper Nylon Nut
Screw Size: M5.5 (#12)
Head Size: 14mm x 16mm
Stem Length: 10mm
Avalon & Camry 2002 - On

UNIT PACKAGE: 25



14739

(Toyota: 90189-05012;
Isuzu: 8941340270)
Natural Nylon

Screw Size: #6
Width: 16mm
Length: 12mm
Snaps into 6mm x 10mm Hole

UNIT PACKAGE: 50



23729

(90189-04007)
White Nylon

Screw Grommet
High Mount Lamp
Screw Size: M4.2 (#8)
Head Size: 7.2mm Sq.
Fits into 7.2mm Hole
Toyota

UNIT PACKAGE: 25



20431

(90189-05105)
Natural Nylon

Front Fender Flare Screw Grommet
Screw Size: M4.2 (#8)
Head Size: 10mm x 15mm
Stem Length: 12mm
RAV4 1996 - On

UNIT PACKAGE: 15



23560

(90189-05105)
Natural Nylon

Front Fender Flare Screw Grommet
Screw: M4.2 (#8)
Head Size: 10mm x 15mm
Fits into 7mm x 13mm Hole
Toyota RAV4 1996 - On

UNIT PACKAGE: 15



19840

(90189-04176)
Natural Nylon

Mudguard Screw Grommet
Screw Size: #8 (M4.2 - 1.41)
Head Size: 10mm x 10mm
Stem Length: 15mm
Corolla 1997 - On
UNIT PACKAGE: 15



21544

(90189-04102)
White Nylon

Screw Grommet with Sealer
Screw Size: M3.2 (#6)
Head Size: 10mm x 10mm
Stem Length: 15mm
Fits into 7mm Square Hole
Toyota Highlander and Lexus IS 250,
IS 350, & IS F 2006 - On

UNIT PACKAGE: 25



25431

(Lexus & Toyota: 90189-04231)
Black Nylon

Wheel Opening Screw Grommet
Screw Size: M4.2 (#8)
Head Size: 8mm x 8mm
Stem Length: 16mm
Overall Height: 17mm
Fits into 6mm Hole
Lexus GS300 2006, GS350, GS450h 2011 - 2007,
GS430 2007 - 2006, GS460 2011 - 2008,
LS460 2017 - 2007, LS600hL 2016 - 2008,
NX200t 2017 - 2015, NX300, RX350L, RX450hL 2021 - 2018,
NX300h 2021 - 2015, RX350, RX450h 2021 - 2010;
Toyota Highlander 2021 - 2014

UNIT PACKAGE: 50



19783

(Ford: N811169-S, W705550-S300;
Toyota: 90075-10801, 90189-06111)
White Nylon

Head Diameter: 13mm
Stem Length: 9mm
Fits into 11mm Hole
Ford, Lexus & Toyota

UNIT PACKAGE: 50



14277

(90189-04008, 90467-12096)
Black Nylon

Screw Grommet
Screw Size: #8
Width: 12mm
Length: 16mm
Height: 15mm
Fits into 10mm x 10mm Hole

UNIT PACKAGE: 15



14263

(90189-04019)
Natural Nylon

Screw Size: #8
Width: 12mm
Length: 14mm

Fits into 6.5mm x 8.5mm Hole

UNIT PACKAGE: 25



21015

(52535-50060, 52535-0E010)
Black Nylon

Front Bumper Screw Grommet

Screw Size: M5.5 - M6 (#12)
Head Size: 17mm x 30mm
Stem Length: 9mm

Lexus IS250, IS350, RX330 & RX350 and
Toyota Camry, Highlander & Tacoma 2001 - On

UNIT PACKAGE: 5



25430

(Lexus & Toyota: 76519-60010)
Pink Nylon

Front Bumper Stay & Filler Panel Grommet

Head Size: 16mm x 16mm
Stem Length: 13.5mm
Overall Height: 15mm
Fits into 8mm Slot

Lexus LX470 2007 - 2002
Toyota Land Cruiser 2007 - 1998

UNIT PACKAGE: 25



14265

(90189-06006)
Natural Nylon

Screw Size: M4.8 (#10)
Head Diameter: 17mm
Fits into 9mm x 9mm Hole

UNIT PACKAGE: 25



21331

(90189-06211)
Black Nylon

Pillar, Rocker and Floor Screw Grommet

Screw Size: M5.5 (#12)
Head Diameter: 17mm
Stem Length: 10mm
Fits into 9mm Square Hole
Camry 2010 - On

UNIT PACKAGE: 25



22939

(Toyota: 90189-09002)
Natural Nylon

Screw Grommet

Screw Size: M4.2 (#8)
Head Diameter: 18mm
Stem Length: 8mm
Fits into 9mm Square Hole
Toyota Corolla 2008 - 2003

UNIT PACKAGE: 25



25433

(Lexus & Toyota: 90189-06066)
Yellow Nylon

Fender & Side Shield Cover Screw Grommet

Screw Size: M4.8 (#10)
Head Diameter: 17mm
Stem Length: 10mm
Overall Height: 11mm

Fits into 9mm x 9mm Hole

Lexus GS Turbo 2017, RX300 2003 - 1999, IS F
2014 - 2008, IS250 2015 - 2007, LS600h 2016 - 2008,
RX350, RX450h 2016 - On, GS200t, IS200t,
RC200t 2017 - 2016, LS460 2017 - 2007,
ES300h ES350, GS450h 2018 - 2013,
GS300 2019 - 2018, GS350 2020 - 2013,
RC300 2020 - 2016, IS300 2021 - 2001, IS350 2021 - 2006,
RC F, RC350 2021 - 2015, LC500 2021 - 2018;
Scion xA 2006 - 2004; Toyota Celica 2005 - 2000,
Corolla 1988 - 1984, Mirai 2021 - On, RAV4 2014 - 2012,
Tercel 1990 - 1987

UNIT PACKAGE: 25



21191

(90189-05142)
Natural Nylon

Headlight Mounting Nylon Nut

Screw Size: M4.2 (#8)
Head Diameter: 17mm
Stem Length: 8mm

Fits into 9mm Square Hole
Toyota & Scion 2001 - On

UNIT PACKAGE: 25



22566

(Toyota: 90189-06238)
Neon Yellow Nylon

Headlamp Assembly Grommet

Screw Size: M4.8 (#8)
Head Diameter: 17mm
Stem Length: 8mm

Fits into 9mm x 9mm Hole

Toyota C-HR, Camry,
Prius C & Prius Prime 2017 - On

UNIT PACKAGE: 25



14268

(Toyota: 90189-04013;
Honda: 90672-671-8110M1)
Natural Nylon

Screw Size: #6

Head Diameter: 14mm

Stem Length: 15mm

Fits into 7mm x 7mm Hole

UNIT PACKAGE: 25



14695

(Toyota: 90189-06042;
Honda: 90661-SC7-003;
Mazda: H001-50-841;
Mitsubishi: MS-480012;
Nissan: 01651-00481, 74798-S9000)
White Nylon

Screw Grommet

Screw Size: #8

Head Diameter: 16mm

Stem Length: 17mm

Fits into 8mm x 8mm Hole

UNIT PACKAGE: 25



14275

(Toyota: 90189-06001;
Mitsubishi: MB-098145;
Nissan: 01281-00023, 01281-00231)
White Nylon

Screw Grommet

Screw Size: M4.8 (#10)
Head Diameter: 18mm
Stem Length: 17mm
Fits into 8.5mm x 8.5mm Hole

UNIT PACKAGE: 25



22213

(90189-06076)
Natural Nylon

Screw Grommet

Screw Size: M5.5 (#12)
Head Diameter: 16mm
Stem Length: 16mm
Fits into 9mm x 9mm Square Hole
Toyota Yaris and Scion xA & xD 2007 - On

UNIT PACKAGE: 25



14281

(Honda: 90662-693-003;
Toyota: 90189-04066)
White Nylon

Screw Grommet

Screw Size: #6
Head Diameter: 14mm
Stem Length: 10mm
Fits into 7mm x 7mm Hole

UNIT PACKAGE: 25



19194

(Toyota: 90189-06028; GM: 94854203)
Black Nylon

**Front & Rear Wheel
Fender Liner Screw Grommet**

Screw Size: #12
Head Diameter: 16mm
Stem Length: 19mm
Fits into 9mm x 9mm Hole
Tacoma, T100 & 4 Runner 1992-On
Chevrolet Nova & Prizm and Pontiac Vibe 1985-On

UNIT PACKAGE: 15



19505

(Toyota: 90189-06029,
90189-06084, 90189-06116;
Hyundai: 86910-22000)
Natural Nylon

Rear Door Panel Screw Grommet

Screw Size: #12
Head Diameter: 18mm
Stem Length: 17mm
Fits into 9mm x 9mm Hole
Camry & Previa 1988 - On; Hyundai 1997 - On

UNIT PACKAGE: 10



19756

(90189-06214)
Black Nylon

**Fender Liner
Screw Grommet**

Screw Size: #12 (M5.5)
Head Diameter: 16mm
Stem Length: 18mm
Sienna, Tacoma & Tundra Pick-Up 1999 - On

UNIT PACKAGE: 15



19742

(90189-06104)
Natural Nylon

Fender Lining Screw Grommet

Screw Size: #12 (M5.5)
Head Diameter: 18mm
Stem Length: 15mm
Fits into a 9mm Square Hole
Lexus IS300 & Toyota Avalon,
Camry & Sienna 1997-On

UNIT PACKAGE: 15



21605

(90189-A0002)
Black Nylon

Screw Grommet

Screw Size: M5.5 (#12)
Head Diameter: 20mm
Stem Length: 17mm
Fits into 9mm x 9mm Hole
Toyota Avalon, Corolla, FJ Cruiser, RAV4,
Sienna, Tacoma & 4Runner and Lexus
GX460, GX470 & LX570 1995 - On

UNIT PACKAGE: 25



21625

(90189-06145)
Black Nylon

Fender Lining Screw Grommet

Screw Size: M5.5 (#12)
Head Diameter: 16mm
Stem Length: 16mm
Fits into 9mm x 9mm Hole
Toyota Prius, Sequoia & T-100
and Lexus CT 200h 1993 - On

UNIT PACKAGE: 15



21792

(90189-06236)
Black Nylon

Fender Liner Screw Grommet

Screw Size: M5.5 (#12)
Head Diameter: 20mm
Stem Length: 17mm
Fits into 9mm x 9mm Hole
Toyota Echo, RAV4
Tacoma & Scion 2005 - On

UNIT PACKAGE: 25



20440

(90189-06065)
Black Nylon

Hood & Fender Screw Grommet

Screw Size: M5.5 (#12)
Head Diameter: 20mm
Stem Length: 18mm
Fits into 9mm x 9mm Hole
Camry & RAV4 1999 - 95

UNIT PACKAGE: 15



19721

(90189-06157)
Black Nylon

Fender Lining Screw Grommet

Screw Size: M5.5 (#12)
Head Diameter: 20mm
Stem Length: 22mm
Fits into 8mm x 8mm Hole
Avalon, Camry, RAV4, Solara
& Tacoma 1995-On

UNIT PACKAGE: 15



21411

(90189-06177)
Black Nylon

Rocker Moulding Screw Grommet

Screw Size: M5.5 (#12)
Head Diameter: 20mm
Stem Length: 22mm
Fits into 9mm x 9mm Hole
Camry 2010 - On

UNIT PACKAGE: 15



20412

(90189-06114)
White Nylon

Front Fender Liner Screw Grommet

Screw Size: M5.5 (#12)
Head Diameter: 18mm
Stem Length: 15mm
Fits into 9mm Square Hole
RAV4 1996 - On

UNIT PACKAGE: 15



14273

(90189-06005)
White Nylon

Screw Grommet

Screw Size: #14 (1/4") or M6.3-1.81
Head Diameter: 18mm
Stem Length: 16mm
Fits into 8mm x 8mm Hole
Lexus & Toyota

UNIT PACKAGE: 50



14267

(90189-06013)
Black Nylon

Screw Grommet

Screw Size: #14 (1/4") or M6.3-1.81
Head Diameter: 20mm
Stem Length: 17mm
Fits into 8mm x 8mm Hole
Lexus & Toyota

UNIT PACKAGE: 25



25432

(Lexus & Toyota: 90189-06027)
Yellow Nylon

Under Cover Screw Grommet

Screw Size: #14 (1/4") or M6.3-1.81
Head Diameter: 20mm
Stem Length: 17mm
Fits into 8mm x 8mm Hole
Lexus GS300 2005 - 1993, GS400 2000 - 1998,
GS430, IS300 2005 - 2001, SC430 2010 - 2002
Toyota 4Runner 1995 - 1984, Corolla 2013 - 2003,
Cressida 1992 - 1989, Matrix 2008 - 2003,
Pick-Up 1995 - 1984, Previa 1997 - 1991, Prius 2009 - 2004

UNIT PACKAGE: 25



22197

(52188-06030)
Yellow Nylon

Rear Bumper Screw Grommet with Sealer

Screw Size: M6 (#14)
Head Diameter: 20mm
Stem Length: 22mm
Fits into 9mm x 9mm Square Hole
Toyota Camry 2011 - 07

UNIT PACKAGE: 15



22096

(52197-22020)
Black Nylon

Rear Bumper Side Bracket Screw Grommet with Sealer

Screw Size: M6.3 (#14)
Head Size: 16mm x 18mm
Stem Length: 19mm
Lexus ES 350 & HS 250h 2012 - 07
Toyota Avalon & Camry 2012 - On

UNIT PACKAGE: 15



21237

(53867-47020)
Dark & Light Gray Nylon

Front Fender Retainer with Sealer

Overall Height: 18mm
Fits into 10mm x 16mm Hole
Prius 2004 - On

UNIT PACKAGE: 10



19535

(90467-07126)
Black Nylon

Cowl Vent Pin Retainer

Head Diameter: 16mm
Stem Length: 17mm
Lexus ES300, Toyota Camry & Tercel 1995 - On

UNIT PACKAGE: 10



23948

(90467-07045-22)
Black Nylon

Cowl Vent Retainer

Head Diameter: 13mm
Stem Length: 15mm
Use with 23947 (99-8148)
Toyota 4 Runner, Tacoma,
Pre-Runner, Tundra 1995 - On

UNIT PACKAGE: 15



21797
(53879-30040)
Black Nylon
Front Bumper Cover Clip
Width: 32mm
Length: 39mm
Use with Auveco 21357
Lexus CT200h & HS250h 2010 - On
Toyota Camry 2012 - On

UNIT PACKAGE: 5



20758
(53879-58010)
Black Nylon
Front Fender & Bumper Cover Clip
Width: 25mm
Length: 34mm
Use with Auveco 20757
Lexus and Toyota 4 Runner, Highlander, Sienna & Solara 2000 - On

UNIT PACKAGE: 5



22412
(Toyota: 53879-0R010; 53879-28010)
Black Nylon
Front Fender Liner Clip
Slotted Head Dia.: 15.3mm
Body Width: 35mm
Toyota Highlander, RAV4 & Tacoma and Scion iQ & xD 2008 - On

UNIT PACKAGE: 25



22489
(Toyota: 53879-30050)
Black Nylon
Fender Liner Retaining Clip
Width: 42mm
Length: 29.5mm
Lexus GS F, GS 200t, GS 350, GS 450h, IS 200t, IS 250, IS 300, IS 350, RC F, RC 200t, RC 300 & RC 350 2013 - On
Toyota C-HR, Prius, Prius Prime & Prius V 2016 - On

UNIT PACKAGE: 15



20757
(47749-58010)
Black Nylon
Front Fender & Bumper Cover Pin Retainer
Head Diameter: 15mm
Stem Length: 25mm
Use with Auveco 20758
Lexus and Toyota 4 Runner Highlander, Sienna & Solara 2000 - On

UNIT PACKAGE: 10



22944
(Lexus & Toyota: 53879-02150; 53879-02150)
Black Nylon
Bumper to Fender Liner Clip
Overall Length: 43mm
Overall Width: 39mm
Lexus ES300 & ES350 2019 - On
Toyota Camry & Corolla 2018 - On

UNIT PACKAGE: 5



22073
(76924-47020)
Black Nylon
Moulding Retainer
Head Diameter: 32mm
Stem Length: 12mm
Fits into 22mm Hole
Lexus CT 200h & Toyota Prius 2011 - On

UNIT PACKAGE: 15



25346
(Lexus & Toyota: 90467-22017)
Black Nylon
Rocker Moulding Retainer
Head Diameter: 32mm
Stem Size: 14mm x 21.5mm
Stem Length: 13.5mm
Fits into 22mm Hole
Lexus NX350h 2022 - On;
Toyota RAV4 2019 - On, Venza 2021-On

UNIT PACKAGE: 25



22166
(76924-12030)
Black Nylon
Rocker & Quarter Moulding Retainer
Head Size: 28mm x 37mm
Stem Length: 10mm
Fits into 17mm x 22mm Hole
Toyota Corolla 2014 - On
Scion iQ 2014 - 2012

UNIT PACKAGE: 25



22353
(90467-09237)
Red Nylon
Body Side Retainer
Head Diameter: 20mm (with Phillips Drive)
Stem Length: 24mm
Overall Length: 26mm
Lexus GS 200h, GS 350, GS 450h, IS 250, IS 350, RC 350, RX 350, RX 450h,
Toyota Camry & Scion iM 2012 - On

UNIT PACKAGE: 25



19686

(90467-05045-22)
Black Nylon

Weatherstrip Retainer
Head Diameter: 12mm
Stem Diameter: 5mm Sq.
Stem Length: 6mm
Solara 1998-On

UNIT PACKAGE: 25



25075

(Lexus & Toyota: 90467-05162-C0)
Black Nylon

Belt Molding Retainer
Head Diameter: 12mm
Stem Size: 5mm x 5.8mm
Stem Length: 10mm
Overall Height: 12mm
Fits into 5mm Hole

Lexus ES 350 2012 - 2007; GS 200t 2019 - 2016;
GS 350 2013 - On; GX 460 2010 - On; IS 200t 2016 - On;
IS 250 2015 - 2012; IS 350 2012 - On; LC 500 2018 - On;
LS 460 2017 - 2007; LS 600 2013 - 2008;
RC 200t 2015 - On; RC 300, RC 350 2015 - On;
RX 330 2006 - 2004; RX 350 2009 - 2007;
RX 400h 2008 - 2006; Toyota 4Runner 2010 - On;
Landcruiser 2008 - On; Matrix 2014 - 2010;
Sienna 2011 - On; Venza 2017 - 2009

UNIT PACKAGE: 25



19312

(90467-05096-22)
Black Nylon

Trim Retainer
Head Diameter: 16mm
Stem Diameter: 5mm
Stem Length: 13mm
Tercel & Paseo 1994-On

UNIT PACKAGE: 25



19643

(90467-06175)
Black Nylon

Luggage Compartment Retainer
Head Diameter: 16mm
Stem Diameter: 6mm
Stem Length: 16mm
Solara 1998-On

UNIT PACKAGE: 15



22369

(Toyota: 90467-08188)
Black Nylon

Luggage Compartment Trim Retainer
Head Diameter: 16mm
Stem Diameter: 8mm
Stem Length: 12mm
Lexus ES 300, LS 430 &
SC 430 2010 - 1996
Toyota Prius & Sienna 2003 - 1998
Scion iQ 2015 - 2012

UNIT PACKAGE: 25



22473

(Toyota: 90467-A0002-C0, 90467-A0002-C4)
Black Nylon

Trunk Side Trim Retainer

Head Diameter: 16mm
Stem Diameter: 8mm
Stem Length: 16mm

Lexus ES300h, IS300, IS350, RC F, RC350 2021 - 2017,
ES350 2021 - 2016, GS F, GS350, RC300 2020 - 2017, GS
Turbo, GS200t, IS200t, LS460, RC200t 2017,
GS300 2019 - 2018, GS450h 2018 - 2017, LC500, LC500h,
LS500 2021 - 2018, LS500h 2020 - 2018, RX330 2011 - 2004,
RX350 2015 - 2010; Toyota Avalon 2022 - 2013,
Camry 2022 - 2012, Corolla 2022 - 2014,
Highlander 2019 - 2015, Prius 2022 - 2017,
Sequoia 2019 - 2017, Sienna 2011 - On,
Tacoma 2022 - 2015, Tundra 2018 - On,
Matrix 2014 - 2009, Venza 2016 - 2009

UNIT PACKAGE: 25



20184

(90467-08186)
Black Nylon

Luggage Compartment Trim Retainer

Head Diameter: 16mm
Stem Diameter: 8mm
Stem Length: 16mm
Camry 1999 - On

UNIT PACKAGE: 25



20878

(90467-A0008)
Black Nylon

Bumper Cover Retainer

Head Diameter: 19mm
Stem Diameter: 7.5mm
Stem Length: 16mm

Toyota, Lexus & Scion 1995 - On

UNIT PACKAGE: 50



21253

(90467-05164-B6)
Gray Nylon

Headliner Retainer

Head Diameter: 20mm
Stem Diameter: 6mm
Stem Length: 15mm
Yaris 2009 - On

UNIT PACKAGE: 25



21332

(90467-05164-E2)
Tan Nylon

Headliner Retainer

Head Diameter: 20mm
Stem Diameter: 6mm
Stem Length: 15mm
Corolla & Yaris 2009 - On

UNIT PACKAGE: 25



19121
(90467-08104)
Gray Nylon

Roof Headliner Retainer
Head Diameter: 20mm
Stem Diameter: 8mm
Stem Length: 20mm
MR2 1990 - On

UNIT PACKAGE: 15



22214
(Lexus: 90467-06015-C0)
Black Nylon

Front & Rear Bumper Retaining Clip
Head Diameter: 7.5mm
Stem Diameter: 5.5mm
Stem Length: 10mm
Lexus GS 300, GS 400 &
GS 430 2005 - 1998

UNIT PACKAGE: 25



21626
(90467-06128)
Black Nylon

Weatherstrip Retaining Clip
Head Diameter: 12mm
Stem Diameter: 6.5mm
Stem Length: 11mm
Camry & RAV4 1992 - On

UNIT PACKAGE: 25



21296
(90080-46010)
Black Nylon

Hood Seal Retaining Clip
Head Diameter: 13mm
Stem Diameter: 7mm
Stem Length: 10mm
Camry 2010 - On

UNIT PACKAGE: 50



18297
(Toyota: 90467-08004, 90467-08011;
GM: 94842841, 94849113)
Black Nylon

Hood Seal Retaining Clip
Head Diameter: 13mm
Stem Length: 11mm
Fits into 6mm Hole
Lexus, Toyota, Geo Prizm & Nova 1985 - On

UNIT PACKAGE: 50



14737
(Toyota: 90467-07050, 90467-08008;
Nissan: 01553-00172)
Black Nylon

Retaining Clip
Head Diameter: 13mm
Stem Length: 15mm
Panel Thickness: 3mm
Fits into 5mm Hole

UNIT PACKAGE: 25



21695
(90467-08045, 90467-08063)
Black Nylon

Hood & Weatherstrip Retaining Clip
Head Diameter: 14mm
Stem Diameter: 9mm
Stem Length: 11mm
Toyota Yaris 2007 - On

UNIT PACKAGE: 25



22212
(53145-60030)
Black Nylon

Front Bumper, Grille & Hood Seal Retaining Clip
Head Size: 4.3mm x 11mm
Stem Diameter: 6.2mm
Stem Length: 10mm
Toyota Avalon, Camry, Highlander, Land Cruiser, Prius &
Venza and Lexus GS 350, GS 450h, IS 250,
IS 350, LX 570, NX 200t, NX 300h, RX 350 & RX 450h
and Scion iQ & tC 2008 - On

UNIT PACKAGE: 100



21643
(Toyota: 90467-08101, 90467-08108)
Black Nylon

Hood to Cowl Top Seal Retaining Clip
Head Size: 7mm x 13mm
Stem Diameter: 7.5mm
Stem Length: 13mm
Lexus ES 300, Toyota Camry 2001 - 1997,
Cressida 1992 - 1989, Sequoia 2007 - 2001,
Solara 2009 - 1999, Tundra 2006 - 1997,
4Runner 2010 - On, Corolla 2008 - 1998,
FJ Cruiser 2014 - 2007, Highlander 2013 - 2008,
Land Cruiser 2020 - 1998, Matrix 2008 - 2003,
Prius 2009 - 2004, Sienna 2020 - 2011

UNIT PACKAGE: 25



22001
(90467-08030)
Black Nylon

Trim Retaining Clip
Head Size: 9mm x 13mm
Stem Diameter: 7.5mm
Stem Length: 10mm
Toyota

UNIT PACKAGE: 25



14736
(90467-06161-01)
Black Nylon

Retaining Clip
Head Diameter: 14mm
Stem Length: 10mm
Panel Thickness: 3mm
Fits into 5mm Hole

UNIT PACKAGE: 25



21634

(90467-10186)
Black Nylon

Dash & Fender Apron Seal Retainer

Head Diameter: 16.5mm
Stem Diameter: 9mm
Stem Length: 13mm

Toyota 4 Runner, FJ Cruiser, Land Cruiser, RAV4, Sequoia, Tundra and Lexus GX 460, GX 470 & LX 470 1996 - On

UNIT PACKAGE: 25



22221

(90080-46327)
Black Nylon

Fender Apron Seal Retainer

Head Diameter: 17mm
Stem Length: 15mm
Fits into 7mm Hole

Toyota Sequoia, Tacoma & Tundra 2000 - On

UNIT PACKAGE: 50



22487

(Toyota: 90467-06192)
Black Nylon

Fender Liner Retaining Clip

Head Size: 14.5mm x 16mm
Stem Diameter: 10.5mm
Stem Length: 10mm
Fits into 8mm Hole

Lexus ES 300h; ES 350; GS 200h; GS 350; GS F, GS 450h; IS 200t; IS 300, IS 350, LS 460, LS 600h L & RC F and Toyota Camry & RAV4 2006 - On

UNIT PACKAGE: 25



19124

(90467-07096)
Black Nylon

Side Trim Panel Retaining Clip

Head Diameter: 16mm
Stem Length: 10mm
Fits into 6mm Hole
4WD Truck 1989-On

UNIT PACKAGE: 10



22395

(Toyota: 90467-09169-C0)
Black Nylon

Lower Fender Shield & Front Floor Carpet Shield Retaining Clip

Head Diameter: 18mm
Stem Length: 12mm
Fits into 7mm Hole

Lexus GX 470, RX 330 & RX 400h 2009 - 2003
Toyota 4Runner, MR2 Spyder Paseo & Tercel 2009 - 1995

UNIT PACKAGE: 15



14347

(Toyota: 90467-10018;
Nissan: 01553-00202)
Black Nylon

Retaining Clip

Head Diameter: 18mm
Stem Length: 12mm
Panel Thickness: 4mm
Toyota and Nissan
Snaps into 7mm Hole

UNIT PACKAGE: 50



16779

(Honda: 74842-659-0030;
Toyota: 90467-12078)
Black Nylon

Retaining Clip

Head Diameter: 18mm
Stem Length: 15mm
Panel Thickness: 6mm
Fits into 8mm Hole

UNIT PACKAGE: 25



19842

(75867-30110)
Black Nylon

Rocker Panel Clip

Head Diameter: 18mm
Stem Length: 22mm
Fits into 9mm Hole
Corolla 1997 - On

UNIT PACKAGE: 15



22103

(53857-47011)
Black Nylon

Front Fender Retainer with Sealer

Head Diameter: 20mm
Stem Diameter: 9mm
Stem Length: 9mm

Lexus CT 200h and Toyota Camry, Prius, RAV4, Yaris & 4-Runner 2010 - On

UNIT PACKAGE: 15



21254

(90467-08136)
Black Nylon

Fender Seal Retaining Clip

Head Diameter: 20mm
Stem Diameter: 8mm
Stem Length: 8mm
Snaps into 7mm Hole
Yaris 2009 - On

UNIT PACKAGE: 25



25076

(Lexus & Toyota: 90467-09051)
Black Nylon

Undercover Retainer

Head Diameter: 20mm
Stem Size: 5mm x 8mm
Stem Length: 10mm
Overall Height: 12mm
Fits into 6mm Hole

Lexus GS 200t 2016; GS 300 2019 - 2018;
GS 350 2013 - On; GS 430 20007 - 2006;
GS 450h 2018 - 2013; GS 460 2011 - 2008;
IS 200t 2017 - 2016; IS 250 2015 - 2006; IS
300 2016 - On; IS 350 2006 - On; LS 460 2017 - 2007; LS
600h 2016 - 2008; RC 200t 2016;
RC 300 2016 - On; RC 350 2015 - On;
Toyota Corolla 1987 - 1984

UNIT PACKAGE: 25



22487

(Toyota: 90467-06192)
Black Nylon

Fender Liner Retaining Clip

Head Size: 14.5mm x 16mm
Stem Diameter: 10.5mm
Stem Length: 10mm
Fits into 8mm Hole

Lexus ES 300h; ES 350; GS 200h;
GS 350; GS F; GS 450h; IS 200t; IS 300,
IS 350, LS 460, LS 600h L & RC F and Toyota
Camry & RAV4 2006 - On

UNIT PACKAGE: 25



21211

(53326-08010)
Black Nylon

Hood Insulation Retaining Clip

Head Diameter: 24mm
Head Length: 24mm
Stem Length: 12mm
Fits into 7mm Hole

Sienna 2009 - On

UNIT PACKAGE: 25



19113

(90467-08124)
Black Nylon

Hood Insulation Retainer

Head Diameter: 25mm
Stem Diameter: 8mm
Stem Length: 12mm
Supra 1993-On
Lexus 1994-89

UNIT PACKAGE: 15



19729

(90467-09050)
Black Nylon

Hood Insulation Retainer

Head Diameter: 25mm
Stem Length: 10mm
Fits into 7mm Hole
Lexus, Camry & Solara 1998-On

UNIT PACKAGE: 15



18878

(90467-08081)
Black Nylon

Hood Insulation Retainer

Head Diameter: 30mm
Stem Length: 16mm
Fits into 6mm Hole
Celica 1993-89

UNIT PACKAGE: 15



19112

(90467-09004)
Black Nylon

Hood Insulation Retainer

Head Diameter: 30mm
Stem Diameter: 8mm
Stem Length: 16mm
Tacoma 1995-On

UNIT PACKAGE: 15



18842

(90467-09006)
Black Nylon

Hood Insulation Retainer

Head Diameter: 30mm
Stem Length: 17mm
Fits into 7mm Hole
Avalon, Camry, Lexus 1988-On

UNIT PACKAGE: 15



14738

(90467-09008)
Black Nylon

Retaining Clip

Head Diameter: 30mm
Stem Length: 17mm
Panel Thickness: 6mm
Fits into 7mm Hole

UNIT PACKAGE: 25



19123

(90467-10107)
Black Nylon

Fender Apron Seal Clip

Head Diameter: 17mm
2WD & 4WD Truck 1988-On

UNIT PACKAGE: 10



21627

(67868-30030)
Black Nylon

Door & Roof Rail Retainer

Head Diameter: 9mm
Stem Diameter: 5.3mm
Stem Length: 8mm
Toyota Camry, Corolla, Corona
& Land Cruiser 1999 - 74
Lexus HS 250h, IS 250, IS 350,
RX 350 & 450h 2006 - On

UNIT PACKAGE: 25



21548

(67869-20030)
Black Nylon

Weatherstrip Retainer

Head Diameter: 10mm
Stem Diameter: 6mm
Stem Length: 10mm

Toyota Camry, Celica, Corolla, Highlander, Matrix,
MR-2, Prius, RAV4, Scion, Solara & Supra and
Lexus IS 300 & SC 430 1990 - On

UNIT PACKAGE: 25



22357

(67869-22010)
Black Nylon

Front Door Weatherstrip Retainer

Head Diameter: 10mm
Stem Diameter: 5.3mm
Stem Length: 12.5mm

Toyota Avalon & Camry 2013 - On

UNIT PACKAGE: 25



22497

(Toyota: 65487-60010)
Black Nylon

Hood Seal Retaining Clip

Head Size: 5mm x 13mm
Stem Diameter: 7mm
Stem Length: 8mm

Lexus CT 200h, ES 300h, ES 350, GS F, GS 200t,
GS 350, GS 450h, LC 500h & LX 570 and
Toyota Land Cruiser & Mirai 2008 - On

UNIT PACKAGE: 25



21552

(90467-04034)
White Nylon

Weatherstrip Retainer

Top Head Size: 5mm x 15mm
Bottom Head Diameter: 9mm
Stem Diameter: 6.5mm
Stem Length: 4mm

Toyota Avalon, Corolla, Highlander, Matrix, Prius, RAV4,
Scion & Venza and Lexus CT 200h, HS 250h,
IS F, IS 250, IS 350, LS 460, LS 600h, RX 350,
RX 400h & RX 450h 2003 - On

UNIT PACKAGE: 25



21707

(Honda: 91563-SCV-003)
(Toyota: 67867-52010, 67867-0D060)
White Nylon

Weatherstrip Retainer

Head Size: 5mm x 15mm
Bottom Head Diameter: 6.5mm
Stem Diameter: 7mm
Stem Length: 8.5mm

Acura TL and Honda Element
Odyssey & Pilot 2003 - On
Toyota Echo, Land Cruiser, Prius, Tacoma &
Yaris and Lexus GS 450, GX 460
& LX 430 and Scion xA & xD 2000 - On

UNIT PACKAGE: 25



19749

(67867-12150)
White Nylon

Weatherstrip Retainer

Head Size: 5mm x 15mm
Stem Length: 10mm
Fits into 6mm Hole
Avalon 1995 - On

UNIT PACKAGE: 15



18692

(Mazda: G031-58-762;
Toyota: 67868-89101, 67867-28030,
67867-89103; Ford: E7GZ-6120586-B)
Natural Nylon

Weatherstrip Retainer

Head Size: 5mm x 15mm
Stem Length: 10mm
Fits into 5mm Hole
4-Runner 1989-83

Mazda 1996-On, Ford

UNIT PACKAGE: 50



20443

(67867-0C010)
Black Nylon

Weatherstrip Retainer

Head Size: 5mm x 15mm
Stem Length: 10mm
Fits into 6mm Hole
Tundra 1999 - On

UNIT PACKAGE: 25



19728

(90467-10146)
Black Nylon

Cowl Panel Retainer

Head Size: 8mm x 17mm
Stem Length: 14mm
Fits into 7mm Hole
Sienna Van 1997 - On

UNIT PACKAGE: 25



21551

(67869-12050)
Black Nylon

Weatherstrip Retainer

Top Head Diameter: 9mm
Bottom Head Diameter: 12mm
Stem Diameter: 7mm
Stem Length: 13mm
Corolla & Prius 2007 - 01

UNIT PACKAGE: 25



25337

(Lexus & Toyota: 76829-60020)
Green Nylon

Interior Trim Panel Retainer

Top Head Diameter: 13mm
Bottom Head Diameter: 16mm
Stem Diameter: 3.7mm
Stem Length: 11.5mm
Overall Length: 16mm

Lexus NX300 2015 - On; Toyota
RAV4 2019 - On, Highlander 2020, Venza 2021 - On

UNIT PACKAGE: 50



16778

(Mazda: 9927-40-822;
Toyota: 62581-14020)
Natural Nylon

Trim Panel Retainer

Top Head Diameter: 14mm
Bottom Head Diameter: 18.5mm
Stem Diameter: 11.5mm
Stem Length: 14mm
Overall Length: 20mm

UNIT PACKAGE: 25



20576

(GM: 88969790;
Toyota: 75867-21010)
Yellow Nylon

Fender Flare Retainer

Top Head Size: 10mm x 13mm
Bottom Head Size: 14mm x 18mm
Stem Diameter: 8.5mm x 8.5mm
Stem Length: 9mm
Overall Length: 13.5mm
Pontiac Vibe & Toyota Echo 2002 - On

UNIT PACKAGE: 25



21226

(75867-02010)
Black Nylon

Rocker Moulding Retainer

Top Head Diameter: 13mm
Bottom Head Diameter: 18mm
Stem Diameter: 9mm
Stem Length: 10mm
Overall Length: 15.5mm
Corolla 2009 - On

UNIT PACKAGE: 25



18861

(90467-10162)
White Nylon

Scuff Plate Retainer

Top Head Diameter: 13mm
Bottom Head Diameter: 18mm
Stem Diameter: 8.5mm x 8.5mm
Stem Length: 12mm
Overall Length: 17mm
Celica 1993-On

UNIT PACKAGE: 15



22056

(75867-30130)
White Nylon

Rocker Moulding Retainer with Sealer

Top Head Diameter: 13mm
Bottom Head Diameter: 18mm
Stem Diameter: 8.5mm x 8.5mm
Stem Length: 13mm

Lexus CT 200h, ES 300h, ES 350,
GS 300, GS 350, GS 430, GS 460,
GS 450h, HS 250h, IS 250, IS 350,
IS F, LS 460, LS 600h & LX 570 and
Toyota Land Cruiser 2006 - On

UNIT PACKAGE: 25



22478

(Toyota: 75867-52020)
Blue Nylon

Rocker Panel Retainer

Top Head Diameter: 13mm
Bottom Head Diameter: 18mm
Stem Diameter: 9.5mm
Stem Length: 13mm

Overall Length: 19mm
Toyota Prius, Prius C, Prius Prime
& Yaris 2012 - On

UNIT PACKAGE: 25



22571

(Toyota: 75867-68010)
White Nylon

Rocker Panel & Wheel Opening Moulding Retainer

Top Head Diameter: 13mm
Bottom Head Diameter: 18mm
Stem Length: 14.5mm
Stem Diameter: 9.5mm

Toyota C-HR, Camry, Prius, Prius C,
Prius Prime, Prius V & RAV4 2012 - On

UNIT PACKAGE: 50



19719

(67921-32010)
White Nylon

Scuff Plate Retainer

Top Head Diameter: 13mm
Bottom Head Diameter: 18mm
Stem Diameter: 10mm
Stem Length: 11mm

Overall Length: 17.5mm
Avalon, Camry & Corolla 1997 - On

UNIT PACKAGE: 15



21538

(75867-33030)
Charcoal Nylon

Rocker Moulding Retainer

Top Head Diameter: 13mm
Bottom Head Diameter: 18mm
Stem Diameter: 9.5mm
Stem Length: 13mm

Overall Length: 18.5mm
Avalon, Camry, Prius, Scion,
Sienna, Solara & Venza 2000 - On

UNIT PACKAGE: 25



21012
(75867-AA010)
Black Nylon

Rocker Panel & Scuff Plate Retainer

Top Head Diameter: 13mm
Bottom Head Diameter: 18mm
Stem Diameter: 9.5mm
Stem Length: 14mm
Overall Length: 18.5mm

Lexus ES300 & ES330 2002 - On
Toyota Avalon, Camry, Scion & Solara 2004 - On

UNIT PACKAGE: 15



18875
(67771-16170)
White Nylon

Door Trim Panel Retainer

Top Head Diameter: 13mm
Bottom Head Diameter: 18mm
Stem Diameter: 11mm
Stem Length: 15mm
Overall Length: 19.5mm

Tercel 1991 - On

UNIT PACKAGE: 25



20473
(67771-12070)
White Nylon

Door Panel & Rocker Moulding Retainer with Sealer

Top Head Diameter: 13mm
Bottom Head Diameter: 18mm
Stem Diameter: 11mm
Stem Length: 14mm
Overall Length: 20mm

Lexus SC300/400 Toyota Avalon & Corolla 1992 - On

UNIT PACKAGE: 15



21795
(67773-0E020)
White Nylon

Door Panel Retainer with Sealer

Top Head Diameter: 13mm
Bottom Head (Including Sealer) Diameter: 18mm
Overall Length: 20mm
Fits into 8.5mm Hole
Lexus RX350 2009 and
Toyota Camry 2012 - On

UNIT PACKAGE: 25



21410
(90467-09212)
White Nylon

Cowl Trim Retainer

Top Head Size: 13mm x 18mm
Middle Head Diameter: 16mm
Bottom Head Diameter: 18mm
Stem Diameter: 10.7mm
Stem Length: 12mm
Overall Length: 16mm

Camry 2010 - On

UNIT PACKAGE: 25



20558
(62217-13010)
White Nylon

Garnish Moulding Retainer

Top Head Diameter: 13mm
Middle Head Diameter: 16mm
Bottom Head Diameter: 15mm
Stem Diameter: 9mm x 9mm
Stem Length: 11mm
Overall Length: 17mm

Lexus and Toyota Corolla,
Matrix & 4 Runner 2003 - On

UNIT PACKAGE: 25



19109
(67771-30070)
Natural Nylon

Door Trim Panel & Garnish Retainer

Top Head Diameter: 13mm
Middle Head Diameter: 16mm
Bottom Head Diameter: 15mm
Stem Diameter: 9.5mm
Stem Length: 11mm
Overall Length: 18mm

Corolla Wagon, Tercel,
T-100 & Tacoma 2WD 1992-On

UNIT PACKAGE: 25



20559
(GM: 88970345;
Toyota: 90467-10167)
Blue Nylon

Garnish Moulding Retainer

Top Head Diameter: 13mm
Middle Head Diameter: 16mm
Bottom Head Diameter: 18mm
Stem Diameter: 9mm x 9mm
Stem Length: 11mm
Overall Length: 18mm

Pontiac Vibe, Lexus and Toyota 2000 - On

UNIT PACKAGE: 25



19203
(67771-89104)
Natural Nylon

**Quarter Board
Inside Trim Panel Retainer**
Top Head Diameter: 13mm
Middle Head Diameter: 16mm
Bottom Head Diameter: 18mm
Stem Diameter: 11mm
Stem Length: 11mm
Overall Length: 18.5mm
Truck 2WD 1997 - 1991

UNIT PACKAGE: 15



20575
(Toyota: 67771-12080;
GM: 88970656)
Yellow & White Nylon

Door Panel & Rocker Moulding Retainer
Top Head Diameter: 13mm
Middle Head Diameter: 16mm
Bottom Head Diameter: 18mm
Stem Diameter: 10mm
Stem Length: 13mm
Overall Length: 20mm
Toyota & Lexus 1998 - On
Pontiac Vibe 2003 - On

UNIT PACKAGE: 15



14728
(67771-22020)
Natural & Yellow Nylon

Door Panel Retainer
Top Head Diameter: 12.5mm
Middle Head Diameter: 16mm
Bottom Head Diameter: 13mm
Stem Diameter: 8.5mm
Stem Length: 11mm
Overall Length: 20mm

UNIT PACKAGE: 25



18876
(Toyota: 90467-10161;
GM: 94858299)
White Nylon

Trim Board Retainer
Top Head Diameter: 13mm
Middle Head Diameter: 16mm
Bottom Head Diameter: 18mm
Stem Diameter: 9mm x 9mm
Stem Length: 14mm
Overall Length: 20mm
Toyota Sienna, Solara & Tercel 1990 - On
Geo Prizm & Pontiac Vibe 1998 - On

UNIT PACKAGE: 25



18844
(67771-06010, 67771-32090)
White Nylon

Trim Panel Retainer
Top Head Diameter: 13mm
Middle Head Diameter: 16mm
Bottom Head Diameter: 18mm
Stem Diameter: 10mm
Stem Length: 13mm
Overall Length: 20mm
Camry 1991-On

UNIT PACKAGE: 10



19910
(90467-08179)
Yellow Nylon

Garnish Retainer
Top Head Diameter: 13mm
Middle Head Diameter: 16mm
Bottom Head Diameter: 18mm
Stem Diameter: 9mm x 9mm
Stem Length: 14mm
Overall Length: 20mm
Tundra 1999 - On

UNIT PACKAGE: 25



18950
(90467-10168)
Black & White Nylon

Garnish Retainer
Top Head Diameter: 13mm
Middle Head Diameter: 16mm
Bottom Head Diameter: 18mm
Stem Diameter: 10mm
Stem Length: 13mm
Overall Length: 20mm
Avalon & Camry 1991 - On

UNIT PACKAGE: 5



20437
(90467-09206)
White Nylon

Trim Panel Retainer
Top Head Diameter: 13mm
Middle Head Diameter: 16mm
Bottom Head Diameter: 18mm
Stem Diameter: 8.5mm x 8.5mm
Stem Length: 15mm
Overall Length: 20mm
RAV4 & Tundra 2000 - On

UNIT PACKAGE: 15



20633
(90467-10188)
Turquoise Nylon

Trim Panel Retainer
Top Head Diameter: 13mm
Middle Head Diameter: 16mm
Bottom Head Diameter: 18mm
Stem Diameter: 8.5mm x 9mm
Stem Length: 14mm
Overall Length: 20mm
Sienna 2004 - On

UNIT PACKAGE: 25



21822
(Peugeot & Citroen: 6822.LL;
Tesla: 1047307-00-A)
White Nylon

**Door Panel, Cowl, Interior Trim,
Headliner, Fender, Liftgate Retainer**
Top Head Diameter: 13mm
Middle Head Diameter: 16mm
Bottom Head Diameter: 18mm
Stem Diameter: 8.5mm x 9mm
Stem Length: 14mm
Overall Length: 20mm

Peugeot, Citroen & Toyota; Tesla 3 2017 - On;
S 2012 - On; X 2015 - On; Y 2020 - On;

UNIT PACKAGE: 25



21102
(90467-A0005)
White Nylon

Door Trim Panel Retainer with Sealer
Top Head Diameter: 13mm
Middle Head Diameter: 16mm
Bottom Head Diameter: 18mm
Stem Diameter: 8.5mm
Stem Length: 14mm
Overall Length: 20mm

Lexus ES 350, GX470, IS250, IS 350, IS F, LS 460 &
LS 600HL and Toyota Camry, FJ Cruiser, Highlander,
RAV4 & 4-Runner 2001 - On

UNIT PACKAGE: 15



19257
(67771-12050)
Red Nylon

**Front & Rear Door
Trim Board Retainer**
Top Head Diameter: 13mm
Bottom Head Diameter: 18mm
Stem Diameter: 9mm
Stem Length: 14mm
Lexus and Toyota Celica, Corolla &
Previa 1990-On

UNIT PACKAGE: 15



14144
(67771-01010)
Black Nylon

Trim Panel Retainer
Top Head Diameter: 13mm
Middle Head Diameter: 15.5mm
Bottom Head Diameter: 18mm
Stem Diameter: 9.5mm
Stem Length: 14mm
Overall Length: 20.5mm

UNIT PACKAGE: 25



14269
(Toyota: 67771-01010, 67771-12010;
Isuzu: 8942264920;
Mazda: 9927-40-825)
White Nylon

Door Panel Retainer
Top Head Diameter: 13mm
Middle Head Diameter: 15.5mm
Bottom Head Diameter: 18mm
Stem Diameter: 9.5mm
Stem Length: 14mm
Overall Length: 20.5mm

UNIT PACKAGE: 25



14270
(67771-22010)
Blue & Natural Nylon

Door Panel Retainer
Top Head Diameter: 13mm
Middle Head Diameter: 15.5mm
Bottom Head Diameter: 18mm
Stem Diameter: 9.5mm
Stem Length: 14mm
Overall Length: 20.5mm

UNIT PACKAGE: 25



15709
(67771-02030)
Natural Nylon

Door Trim Retainer
Top Head Diameter: 13mm
Middle Head Diameter: 16mm
Bottom Head Diameter: 17.5mm
Stem Diameter: 9.5mm
Stem Length: 13mm
Overall Length: 21mm
Corolla 1990 - On

UNIT PACKAGE: 50



19898
(67771-02030)
Yellow Nylon

Trim Panel Retainer
Top Head Diameter: 13mm
Middle Head Diameter: 16mm
Bottom Head Diameter: 18mm
Stem Diameter: 9.5mm
Stem Length: 13mm
Overall Length: 21mm
Corolla 1990 - On

UNIT PACKAGE: 50



15707
(67771-03030)
Gray Nylon

Door Trim Retainer
Top Head Diameter: 13mm
Middle Head Diameter: 16mm
Bottom Head Diameter: 17.5mm
Stem Length: 14mm
Stem Diameter: 10mm
Overall Length: 21mm
Camry 1988 - On

UNIT PACKAGE: 50



19108
(67771-16080)
Natural Nylon

**Door Trim Panel & Back Panel
Upper Garnish Retainer**
Top Head Diameter: 13mm
Middle Head Diameter: 16mm
Bottom Head Diameter: 18mm
Stem Diameter: 9.5mm
Stem Length: 14mm
Overall Length: 21mm
Truck 1988-On

UNIT PACKAGE: 10



18874
(67771-16120)
Gray Nylon

**Front & Rear Door
Trim Panel Retainer**
Top Head Diameter: 13mm
Middle Head Diameter: 16mm
Bottom Head Diameter: 18mm
Stem Diameter: 9.5mm
Stem Length: 15mm
Overall Length: 21mm
Tercel 1994 - On

UNIT PACKAGE: 15



19016
(67771-12040)
Dark Gray Nylon

Door Trim Panel Retainer
Top Head Diameter: 13mm
Middle Head Diameter: 16mm
Bottom Head Diameter: 18mm
Stem Diameter: 9.5mm
Stem Length: 15mm
Overall Length: 21mm
Cressida 1992 - 88

UNIT PACKAGE: 15

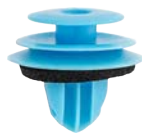

22486
(Toyota: 67771-26240)
Blue Nylon

Door Trim Retainer with Sealer
Top Head Diameter: 13mm
Middle Head Diameter: 16mm
Bottom Head Diameter: 18mm
Stem Diameter: 9.6mm
Stem Length: 10mm
Overall Length: 16.5mm
Lexus CT 200h, ES 300h, ES 350, GS 200t, GS 350, IS 200t, IS 250, IS 300, LC 500h, LS 460, NX 200t, NX 300h, RC 200t, RC 300, RC 350, RX 350 & RX 450h
and Toyota FJ Cruiser, Prius C & Prius V 2006 - On

UNIT PACKAGE: 25



19210
(67771-04040)
Natural Nylon

Front Door Trim Panel Retainer
Top Head Diameter: 13mm
Middle Head Diameter: 16mm
Bottom Head Diameter: 18mm
Stem Diameter: 10mm
Stem Length: 14mm
Overall Length: 22mm
Tacoma 1995 -On

UNIT PACKAGE: 50



19129
(Toyota: 67771-30090;
GM: 95008221)
Yellow Nylon

**Door Trim Panel & Back Panel
Lower Garnish Retainer**
Top Head Diameter: 13mm
Middle Head Diameter: 16mm
Bottom Head Diameter: 18mm
Stem Diameter: 9.5mm
Stem Length: 14mm
Overall Length: 23mm
Land Cruiser & 2WD Truck 1991 - On

UNIT PACKAGE: 15



23559
(67771-30090, 67771-28030)
Yellow Nylon

**Door Trim & Back Panel
Lower Garnish Retainer**
Top Head Diameter: 13mm
Middle Head Diameter: 16mm
Bottom Head Diameter: 18mm
Stem Diameter: 10mm
Stem Length: 17mm
Lexus LX 450 1996 - 1997
Toyota Land Cruiser 1991 - 1997

UNIT PACKAGE: 15



22460

(Toyota: 62489-0E010)
White Nylon

Door Sill, Headliner, Liftgate Trim Cover, Pillars, Scuff Plate & Window Trim Retainer

Top Head Diameter: 13mm
Middle Head Diameter: 16mm
Bottom Head Diameter: 18mm
Stem Diameter: 11mm
Stem Length: 14mm
Overall Length: 20mm

Lexus RX 350 & RX 450h 2015 - 2010
Toyota Avalon, Corolla, Highlander, RAV4, Sienna & Venza 2013 - On

UNIT PACKAGE: 25



22845

(Toyota: 90467-09232)
Red Nylon

Trim Panel Retainer

Top Head Diameter: 13mm
Middle Head Diameter: 16mm
Bottom Head Diameter: 18mm
Stem Diameter: 9mm
Stem Length: 15mm

Lexus IS 250 & IS 350 2015 - 2010
LC 500, LC 500h, LS 500, LS 500h, NX 200t, NX 300 & NX 300h and Toyota Highlander & Tacoma 2014 - On

UNIT PACKAGE: 25



22125

(90467-05170)
Black Nylon

Front Bumper Push-Type Retainer

Head Diameter: 10mm
Stem Length: 10mm
Fits into 5mm Hole

Lexus IS 250, IS 350 & NX 300h and Toyota Corolla, Highlander, Matrix & RAV4 2012 - On

UNIT PACKAGE: 25



21103

(90467-05090-B1)
Gray Nylon

Front Bumper Fascia Push-Type Retainer

Head Diameter: 10mm
Stem Length: 12mm
Fits into 5mm Hole

Corolla, Matrix & Scion 2008 - On

UNIT PACKAGE: 10



17383

(GM: 94847334, 96057847;
Toyota: 90467-07066;
Suzuki: 09409-07313)
Black Nylon

Radiator Grille & Trim Panel Push-Type Retainer

Head Diameter: 11mm
Stem Length: 14mm (Excluding the Pin)
Fits into 7mm Hole

Toyota, Suzuki and Geo Tracker & Prizm 1992 - 89

UNIT PACKAGE: 10



21218

(90467-05063-C0)
Black Nylon

Front Bumper Push-Type Retainer

Head Diameter: 11mm
Stem Length: 8mm
Fits into 5mm Hole
Corolla 2009 - On

UNIT PACKAGE: 15



21249

(90467-07071-22)
Black Nylon

Bumper Cover Push-Type Retainer

Head Diameter: 11mm
Stem Length: 9mm (Excluding the Pin)
Fits into 7mm Hole
Yaris 2009 - On

UNIT PACKAGE: 25



20196

(90467-06133-C0)
Black Nylon

Rocker Panel Push-Type Retainer

Head Diameter: 14mm
Stem Length: 8mm
Fits into 6mm Hole
4-Runner 1998 - On

UNIT PACKAGE: 15



21849

(90467-05136)
Black Nylon

Inner Door Lock Plate, Engine Cover & Outside Air Duct Push-Type Retainer

Head Diameter: 13mm
Stem Length: 15mm
Fits into 5.5mm Hole
Lexus & Toyota 2012 - On

UNIT PACKAGE: 25



21104

(90467-07190-B2)
Black Nylon

Interior Trim Push-Type Retainer

Head Diameter: 14mm
Stem Length: 14mm
Fits into 7mm Hole
Echo & Scion 2004 - On

UNIT PACKAGE: 10



23935

(90467-06133, 94858343)
Nylon

Rocker Panel Push-Type Retainer

Head Diameter: 14mm
Stem Length: 9mm (Excluding Pin)
Fits in 6mm Hole
Toyota 1998 - On

Pontiac Vibe 2003 - On

UNIT PACKAGE: 15



23738
(10116-41810)

Trim Push-Type Retainer
Head Diameter: 15mm
Stem Diameter: 7mm
Stem Length: 14mm
Toyota

UNIT PACKAGE: 25



17162
(GM: 96057846;
Toyota: 90467-07041)
Black Nylon

Push-Type Retainer
Head Diameter: 15mm
Stem Length: 8mm (Excluding the Pin)
Fits into 6.3mm Hole
Geo Metro & Tracker and
Toyota 1989 - On

UNIT PACKAGE: 10



21120
(90467-07192)
Black Nylon

Cowl Vent Push-Type Retainer
Head Diameter: 15mm
Stem Length: 9mm (Excluding the Pin)
Fits into 7mm Hole
RAV4 2002 - On

UNIT PACKAGE: 15



14260
(Toyota: 90467-06017;
Mazda: 9926-50-625;
GM: 20426301)
Black Nylon

Push-Type Retainer
Head Diameter: 15mm
Stem Length: 12mm
Fits into 7mm Hole

UNIT PACKAGE: 15



19013
(90467-07059-22)
Black Nylon

**Rear Door Trim &
Luggage Compartment Door
Push-Type Retainer**
Head Diameter: 15mm
Stem Length: 10mm
Fits into 7mm Hole
Camry & Celica 1990-On

UNIT PACKAGE: 15



17206
(90467-09145)
Black Nylon

Bumper Cover Push-Type Retainer
Head Diameter: 15mm
Stem Length: 12mm (Excluding Pin)
Fits into 9mm Hole
Camry 1992-On

UNIT PACKAGE: 15



21011
(90467-07188)
Black Nylon

Push-Type Retainer
Head Diameter: 15mm
Stem Length: 17mm
Fits into 7mm Hole
Camry, Tundra & 4-Runner 2002 - On

UNIT PACKAGE: 15



23958
(90467-07193)
Black Nylon

Cowl Vent Push-Type Retainer
Head Diameter: 15mm
Stem Length: 20mm
Fits into 7mm Hole
Toyota RAV4 2002

UNIT PACKAGE: 15



19552
(90467-07146)
Black Nylon

**Cowl Panel & Luggage
Compartment Retainer**
Head Diameter: 16mm
Stem Length: 9mm
Fits into 7mm Hole
Avalon, Camry, Celica & Solara 1993 - On

UNIT PACKAGE: 15



21624
(90467-10206)
Black Nylon

Cowl Push-Type Retainer
Head Diameter: 16mm
Stem Length: 10mm
Fits into 8mm Hole
Toyota Camry, Sequoia, Tundra & Yaris and
Lexus ES 350, RX350 & RX 450h 2006 - On

UNIT PACKAGE: 15



21325
(90080-46294)
Black Nylon

Turn Signal Light & General Purpose Push-Type Retainer
Head Diameter: 16mm
Stem Length: 14mm
Fits into 7mm Hole
Tundra 2003 - On

UNIT PACKAGE: 10



20335
(53879-60010)
Black Nylon

Fender Liner Push-Type Retainer
Head Diameter: 18mm
Stem Length: 7mm
Fits into 7mm Hole
Land Cruiser & RAV4 1998 - On

UNIT PACKAGE: 15



20869
(GM: 88970767;
Toyota: 90467-10183)
Black Nylon

Front Fender Liner Push-Type Retainer
Head Diameter: 18mm
Stem Length: 7.5mm
Fits into 7mm Hole
Celica, Corolla, Matrix & Solara, Lexus and Pontiac Vibe 1999 - On

UNIT PACKAGE: 10



19490
(90467-06150)
Black Nylon

Back Garnish Trim Panel Push-Type Retainer
Head Diameter: 18mm
Stem Length: 8mm
Fits into 6mm Hole
Tacoma 1995 - On

UNIT PACKAGE: 10



23943
(90467-07085)
Gray Nylon

Door Panel Push-Type Retainer
Head Diameter: 18mm
Stem Length: 9mm
Fits into 6.3mm Hole

Toyota Camry, RAV4, 4 Runner & Tacoma 1995 - On

UNIT PACKAGE: 25



20349
(Toyota: 90467-08185;
Nissan: 01553-09611)
Black Nylon

Bumper Clip Push-Type Retainer
Head Diameter: 18mm
Stem Length: 10mm (Excluding the Pin)
Fits into 8mm Hole
Lexus & Toyota 2002 - On
Nissan 1994 - On

UNIT PACKAGE: 15



21547
(90467-09185)
Black Nylon

Front Spoiler & Grille Push-Type Retainer
Head Diameter: 18mm
Stem Length: 10mm
Fits into 9mm Hole
Toyota Celica, Sequoia, Sienna & 4 Runner and Lexus HS 250h 1994 - On

UNIT PACKAGE: 25



21123
(75867-30120)
Black Nylon

Rocker Moulding Push-Type Retainer
Head Diameter: 18mm
Stem Length: 12mm (Excluding the Pin)
Fits into 8mm Hole
Toyota Camry and Lexus GS350, GS430, GS460 & LS460 2007 - On

UNIT PACKAGE: 15



16784
(Nissan: 80999-05N07;
Toyota: 90467-07043)
Black Nylon

Push-Type Retainer
Head Diameter: 18mm
Stem Length: 11mm (Excluding the Pin)
Fits into 7mm Hole

UNIT PACKAGE: 25



19416
(90467-09139)
Black Nylon

Bumper Cover & Wheel Housing Push-Type Retainer
Head Diameter: 18mm
Stem Length: 12mm (Excluding the Pin)
Fits into 9mm Hole
Honda, Mazda 626 & Toyota Corolla 1992 - On

UNIT PACKAGE: 15



21702
(90467-10170-C0)
Black Nylon

Cowl Vent, Upper Radiator Cover & Wheel Apron Push-Type Retainer
Head Diameter: 18mm
Stem Length: 12mm
Fits into 10mm Hole
Lexus LS 460, LS 600, RX 350
& RX 450 and Toyota RAV4 2006 - On

UNIT PACKAGE: 10



21225
(53888-48010)
Black Nylon

Wheel Opening Push-Type Retainer
Head Diameter: 18mm
Stem Length: 14mm
Fits into 7mm Hole
Highlander 2001 - On

UNIT PACKAGE: 5



18873
(52161-16010, 52161-02020)
Black Nylon

Rear Bumper Cover Push-Type Retainer
Head Diameter: 18mm
Stem Length: 28mm
Fits into 9mm Hole
Tercel 1988 - On

UNIT PACKAGE: 6



20931
(52161-20010)
Black Nylon

Bumper Cover & Grille Push-Type Retainer
Head Diameter: 18mm
Stem Length: 31mm
Fits into 9mm Hole
Toyota 2000 - On

UNIT PACKAGE: 15



25338
(Lexus & Toyota: 90467-07222)
Black Nylon

Mud Guard & Rocker Panel Moulding Extension Push-Type Retainer
Head Diameter: 19mm
Stem Length: 17mm
Stem Diameter: 7mm
Fits into 7mm Hole
Panel Range: 5.5mm
Lexus ES300, 350 2020-2019,
Toyota Avalon 2019-On, Camry 2018-On,
Prius 2016-On

UNIT PACKAGE: 25



22400
(Toyota: 90467-07217)
Black Nylon

Radiator Support Access Cover, Air Deflector & Side Shield Push-Type Retainer
Head Diameter: 19mm
Stem Length: 9mm
Fits into 7mm Hole
Lexus LX, IS, GS, RX 350 & RX 450h and Toyota Camry, Corolla, Land Cruiser Prius, RAV4 & Yaris 2010 - On

UNIT PACKAGE: 25



22126
(53384-68010)
Black Nylon

Front Grille Push-Type Retainer
Rubber Head Diameter: 19mm
Bottom Head Diameter: 18mm
Stem Length: 28mm
Fits into 9mm Hole
Scion tC & Toyota RAV4 2005 - On

UNIT PACKAGE: 15



19908
(90467-07121)
Black Nylon

Door Trim Panel Push-Type Retainer
Head Diameter: 20mm
Stem Length: 8mm (Excluding the Pin)
Fits into 7mm Hole
RAV4 1997 - On

UNIT PACKAGE: 10



19907
(90467-07121-B2)
Nylon

Door Trim Panel Push-Type Retainer
Head Diameter: 20mm
Stem Length: 8mm Excluding Pin
Fits into 7mm Hole
RAV4 1997 - On

UNIT PACKAGE: 10



20577
(GM: 88970494, 88973676
Toyota: 90467-07168)
Black Nylon

Rocker Panel & Garnish Moulding Push-Type Retainer
Head Diameter: 20mm
Stem Length: 8mm Excluding Pin
Fits into 7mm Hole
Pontiac Vibe 2003 - On
Lexus & Toyota 2000 - On

UNIT PACKAGE: 15



18888

(90467-07166)
Black Nylon

**Front Fender Liner
Push-Type Retainer**

Head Diameter: 20mm
Stem Length: 8mm (Excluding the Pin)
Fits into 7mm Hole
Tercel 1994 - On

UNIT PACKAGE: 15



20908

(Toyota: 90467-07164;
Suzuki: 09409-07332)
Black Nylon

**Fender Splash Shield
Push-Type Retainer**

Head Diameter: 20mm
Stem Length: 10mm
Fits into 7mm Hole
Camry, Echo, MR2 & Sienna 1997 - On
Suzuki 1999 - On

UNIT PACKAGE: 10



23959

(90467-07195)
Black Nylon

Cowl Vent Push-Type Retainer

Head Diameter: 20mm
Stem Length: 8.5mm
Fits into 7mm Hole
Toyota RAV4 2002

UNIT PACKAGE: 15



20955

(90467-07201)
Black Nylon

**Engine Under Cover
Push-Type Retainer**

Head Diameter: 20mm
Stem Length: 10mm
Fits into 7mm Hole
Lexus ES300/330 and Toyota Avalon,
Camry & Solara 2002 - On

UNIT PACKAGE: 10



19128

(90467-07044)
Black Nylon

**Quarter Panel Wheel Opening
Moulding Push-Type Retainer**

Head Diameter: 20mm
Stem Length: 9mm
Fits into 7mm Hole
T-100 1992 - On

UNIT PACKAGE: 10



22439

(Toyota: 90467-07215)
Black Nylon

Fender Liner Push-Type Retainer

Head Diameter: 20mm
Stem Length: 10mm
Fits into 7mm Hole
Scion tC and Toyota 4Runner,
Avalon, Camry, Corolla,
Highlander, Land Cruiser, Prius,
RAV4, Tacoma & Tundra 2010 - On

UNIT PACKAGE: 25



21294

(90467-07214)
Black Nylon

**Radiator Splash Shield
Push-Type Retainer**

Head Diameter: 20mm
Stem Length: 9mm
Fits into 7mm Hole
Camry 2007 - On

UNIT PACKAGE: 25



19239

(GM: 11519949;
Honda: 91512-SX0-003;
Mitsubishi: MU000319;
Lexus & Toyota: 90467-08217)
Black Nylon

**Front Fender, Bumper Support, Interior
Trim & Washer Tank Push-Type Retainer**

Head Diameter: 20mm
Stem Length: 11mm
Fits into 8mm Hole
Acura 3.5RL, Honda Accord, Prelude &
Odyssey 1994 - On; Mitsubishi Lancer 2002 - On;
GM 1997 - On; Lexus GX470 2009 - 2003; Toyota
4Runner 2009 - 2003, FJ Cruiser 2014 - 2007,
Tacoma 2016 - 2005

UNIT PACKAGE: 25



21010

(90467-09166)
Black Nylon

Push-Type Retainer

Head Diameter: 20mm
Stem Length: 9mm
Fits into 9mm Square Hole
Camry 2006 - On

UNIT PACKAGE: 15



21856

(51454-48010, 51454-0E010)
Black Nylon

**Front Bumper Extension
Mounting Bracket Push-Type Retainer**

Head Diameter: 20mm
Stem Length: 12mm
Fits into 10mm Hole
Lexus IS CV, F, RX330 & RX400 Hybrid 2006 - On
Toyota Highlander, Sienna & Venza 2009 - On

UNIT PACKAGE: 15



22424
(Mazda: B45A-56-146A;
Toyota: 90118-WB048)
Black Nylon

Bumper, Engine Cover, Fender & Quarter Panel Push-Type Retainer

Head Diameter: 20mm
Stem Length: 13mm
Fits into 8mm Hole

Mazda 3, 5, 6, CX-3, CX-5, CX-9 & MX-5 Miata 2012 - On
Scion iA 2016 - On

UNIT PACKAGE: 25



21596
(75867-06030)
Black Nylon

Rocker Panel Push-Type Retainer

Head Diameter: 20mm
Stem Length: 16mm
Fits into 8mm Hole

Toyota & Lexus 2007 - On

UNIT PACKAGE: 25



19140
(Acura: 90505-SL0-003;
GM: 94852368;
Mitsubishi: MB888869;
Toyota: 90467-08155)
Black Nylon

Push-Type Retainer

Head Diameter: 20mm
Stem Length: 21mm
Fits into 8mm Hole

Acura, Dodge Avenger, Eagle Talon,
Geo Prizm, Mitsubishi Eclipse & Galant
and Toyota 1993-On

UNIT PACKAGE: 5



19739
(90467-09127)
Black Nylon

Bumper Cover Push-Type Retainer

Head Diameter: 20mm
Stem Length: 26mm
Fits into 9mm Hole

Avalon, Camry,
Corolla & Solara 1998 - On

UNIT PACKAGE: 10



21860
(51453-48010, 51453-0E010)
Black Nylon

Front Side Lower Fender Panel Bracket Push-Type Retainer

Head Diameter: 22mm
Stem Length: 14mm
Fits into 13mm Hole

Lexus RX330 2009-2004
Toyota Highlander 2010 - On

UNIT PACKAGE: 15



21366
(90467-09227)
Black Nylon

Bumper & Engine Under Cover Push-Type Retainer

Head Diameter: 22mm
Stem Length: 15mm
Fits into 9mm Hole

4 Runner, RAV4 & Scion XB 2006 - On

UNIT PACKAGE: 10



19219
(90467-09096)
Black Nylon

Front Bumper Push-Type Retainer

Head Diameter: 15mm
Stem Length: 27mm
Fits into 9mm Hole

Lexus LS400 1993-On
Celica & Supra 1989-On

UNIT PACKAGE: 10



22502
(Toyota: 76923-52021)
Black Nylon

Side Mud Guard Push-Type Retainer

Head Diameter: 29mm
Stem Length: 10mm
Fits into 22mm Hole

Lexus GS F, GS 200t, GS 350,
GS 450h, IS 200t, IS 250, IS 300,
IS 350, RC F, RC 200t, RC 300
& RC 350 2013 - On

Toyota Yaris 2011 - 2007
Scion xD 2014 - 2008

UNIT PACKAGE: 15



22072
(76923-47010)
Black Nylon

Rocker Moulding Push-Type Retainer

Head Diameter: 38mm
Stem Length: 32mm
Fits into 22mm Hole

Lexus HS 250h & CT 200h
and Toyota Prius 2010 - On

UNIT PACKAGE: 5



22400
(Toyota: 90467-07217)
Black Nylon

Radiator Support Access Cover, Air Deflector & Side Shield Push-Type Retainer

Head Diameter: 19mm
Stem Length: 9mm
Fits into 7mm Hole

Lexus LX, IS, GS, RX 350 &
RX 450h and Toyota Camry, Corolla,
Land Cruiser Prius, RAV4
& Yaris 2010 - On

UNIT PACKAGE: 25



22472

(Toyota: 90467-06005)
Black Nylon

Hood Release Cable Clamp Clip

Head Size: 16mm x 21mm
Holds 5mm Diameter Rod
Stem Diameter: 12mm
Stem Length: 9mm
Lexus CT 200h, GX 470, HS 250h,
LX 570, NX 200t, NX 300h, RX 350
& RX 450h 2003 - On

Toyota 4Runner, Avalon, Camry, Celica,
C-HR, Corolla, Land Cruiser, Matrix, Mirai,
Prius, RAV4, Tacoma & Yaris 1994 - On

UNIT PACKAGE: 25



14732

(53455-14020)
Nylon

Hood Prop Rod Clip

Holds 8mm Diameter Rod
Snaps into 14mm Hole

UNIT PACKAGE: 15



16780

(Nissan: 99604-H1400;
Toyota: 58788-13010)

Hood Prop Rod Clip

Holds 11mm Diameter Rod
Fits into 10mm x 12mm Hole

UNIT PACKAGE: 10



17631

(90959-01136)
Nylon

Hood Prop Rod Clip

Holds 6mm & 7mm Rods
Toyota

UNIT PACKAGE: 25



19529

(53455-33010, 53455-33011)
Natural Nylon

Hood Prop Rod Clip

Holds 9mm Rod
Fits into 10mm Square Hole
Camry 1996 - On

UNIT PACKAGE: 15



21336

(69293-30030)
Natural Nylon

Door Lock Rod Clip

Rod Size: 5mm
Overall Height: 20mm
Fits into 8mm Hole
Toyota & Lexus 1993 - On

UNIT PACKAGE: 10



20469

(69293-12030)
Natural Nylon

Door Lock Rod Clip

Rod Size: 5mm
Right (Passenger) Side
Lexus ES 300 2001 - 97
Toyota Camry, Celica, Corolla, Echo,
Highlander, MR2, RAV4, Tundra and
4-Runner 1994 - On

UNIT PACKAGE: 10



20470

(69293-12040)
Yellow Nylon

Door Lock Rod Clip

Rod Size: 5mm
Left (Driver) Side
Lexus ES 300 2001 - 97
Toyota Camry, Celica, Corolla, Echo,
Highlander, MR2, RAV4, Tundra and
4-Runner 1994 - On

UNIT PACKAGE: 10



20534

(69293-12050)
Natural Nylon

Door Lock Rod Clip

Rod Size: 5mm
Fits into 8.5mm Hole
Right (Passenger) Side
Lexus ES250, 300 & RX300
and Toyota Tacoma 1990 - On

UNIT PACKAGE: 10



20535

(69293-12060)
Yellow Nylon

Door Lock Rod Clip

Rod Size: 5mm
Fits into 8.5mm Hole
Left (Driver) Side
Lexus ES250, 300 & RX300
and Toyota Tacoma 1990 - On

UNIT PACKAGE: 10



25331

(Honda: 95551-11000)
Black Nylon

Body Hole Plug

Head Diameter: 19mm
Fits into 11mm Hole
Overall Height: 8mm
Honda Accord 2017-2003, Civic 2020-2006,
Clarity 2021-2017, CR-V 2019-2002,
CR-Z 2016-2011, Element 2006-2003, Fit 2020-2007,
HR-V 2020-2016, Insight 2014-2000, Odyssey 2008-2005,
Pilot 2008-2003, Ridgeline 2008-2006,
S2000 2009-2000

UNIT PACKAGE: 50



25332

(Honda: 95551-15000)
Black Nylon

Body Hole Plug

Head Diameter: 23mm
Fits into 15mm Hole
Overall Height: 7.5mm

Acura MDX 2010-2007, RL 2012-1999, RLX 2020-2014, RSX 2006-2002, TL 2007-2004, TSX 2011-2004;
Honda Accord 2017-2000, Civic 2020-2001,
Clarity 2021-2017, CR-V 2019-2002, CR-Z 2016-2011,
Element 2006-2003, Fit 2020-2007, HR-V 2020-2016,
Insight 2014-2004, Odyssey 2008-2005, Pilot 2008-2006,
Ridgeline 2009-2006, S2000 2009-2000

UNIT PACKAGE: 50

21553

(82711-12200)
Black Nylon



Photo not actual size
Length: 170mm (6-3/4")

Cable Strap

Width: 7mm (7/32")

Max. Bundle Diameter: 40mm (1-9/16")

Camry, Celica, Corolla, Cressida,
Land Cruiser, MR-2, Paseo, Previa, RAV4, Supra, T-100,
Tercel & 4-Runner 1998 - On

UNIT PACKAGE: 25

20380

(Not Supplied by O.E.M.)
Black Nylon



Photo not actual size

Cable Strap

Width: 5mm (3/16")

Length: 200mm (8")

Max. Bundle Diameter: 44mm (1-3/4")

Fits into 6.3mm (1/4") Hole
Import Cars

UNIT PACKAGE: 25

23785

(90520-01274)

**Window Crank Handle
Retaining Clip**

Toyota

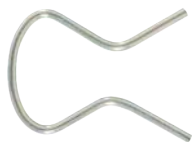

UNIT PACKAGE: 50

16306

(90183-03001)

Front Bumper Cushion Clip

Toyota 1982 - On



UNIT PACKAGE: 25

16671

(90468-04030)

Bumper Strip Retainer

Toyota 1984 - On



UNIT PACKAGE: 25



21611

(76879-44010)
Dacromet

**Front and Rear Spoiler
Locking Fastener**

Width: 16mm

Corolla, Matrix, Prius & Solara 2003 - On

UNIT PACKAGE: 15



22097

(90950-01620)
Black Nylon

Hole Plug

Head Diameter: 30mm
Height: 5.6mm

Fits into 22mm Hole

Lexus ES, RX & SC; Scion iQ,
tC, xA, xB & xD and Toyota Avalon,
Camry, Celica, Corolla,
FJ Cruiser, Highlander, Matrix, Prius,
RAV4, Sequoia, Sienna,
Tacoma, Tundra & Yaris 1984 - On

UNIT PACKAGE: 15



22708

(Toyota: 90467-14053)
Black Nylon

Floor Under Cover Nut

Hex: 12mm

Flange O.D.: 23.8mm

Overall Height: 11mm

Fits onto 6mm Stud

Use with Auveco Nos. 22709 & 22843

Lexus ES 300h, ES 350, GS F, GS 200t, GS 300, GS 350,
GS 430, GS 450h, GS 460, HS 250h, IS F, IS 200t, IS 250, IS
300, IS 350, LC 500, LC 500h, LS 430, LS 460, LS 500h, LS
600h L, RC F, RC 200t, RC 300, RC 350, RX 350, RX 350L,
RX 450h, RX 450h L & SC 430 and
Toyota Avalon, Camry, Corolla, Corolla iM, Highlander,
Prius, Prius C, Prius V, RAV4 & Venza and
Scion iM & xB 2006 - On

UNIT PACKAGE: 15



22709

(Toyota: 90561-13003)
Black Nylon

Floor Under Cover Nut Spacer

Outside Diameter: 16mm

Inside Diameter: 12.5mm

Flange Diameter: 23.5mm

Height: 5.5mm

Use with Auveco No. 22708

Lexus ES 300h, ES 350, GS F, GS 200t, GS 300, GS 350,
GS 430, GS 450h, GS 460, HS 250h, IS F, IS 200t, IS 250, IS
300, IS 350, LC 500, LC 500h, LS 430, LS 460, LS 500h, LS
600h L, RC F, RC 200t, RC 300, RC 350, RX 350, RX 350L,
RX 450h, RX 450h L & SC 430 and Toyota Avalon,
Camry, Corolla, Corolla iM, Highlander, Prius, Prius C,
Prius V, RAV4 & Venza and Scion iM & xB 2006 - On

UNIT PACKAGE: 15



22843

(Toyota: 90561-A0001)
White Nylon

Under Cover Nut Spacer
Outside Diameter: 16mm
Inside Diameter: 12.5mm
Flange Diameter: 23.5mm
Height: 5.5mm

Use with Auveco No. 22708

Lexus ES 300h, ES 350, LS 500, RX 350L & RX 450hL and
Toyota Avalon, Camry & Highlander 2012 - On

UNIT PACKAGE: 15



25259

(Toyota: 90467-10216)
Black Nylon

Fender Apron & Interior Trim Push-Type Retainer

Head Diameter: 20mm
Stem Length: 13mm
Fits into 10mm Hole

Toyota Avalon, RAV4 2013 - On, Camry 2018 - On, CH-R 2017 - On, Corolla 2019 - On, Highlander 2014 - On: Land Cruiser 2016 - On, Mirai, Sienna, Venza 2021 - On, Prius 2012 - On, Yaris 2018 - 2015, Scion iQ 2013

UNIT PACKAGE: 25



14750

(Toyota: 53879-14010-A, 53879-14020, 53879-22030;
GM: 94841226;
Mazda: LA01-56-135)
Black Nylon

Fender/Wheel Housing

Screw Size: #10
Width: 20mm
Length: 31mm
Panel Range: Up to 1mm
Center of Hole to Edge: 11mm
Toyota, Geo and Mazda

UNIT PACKAGE: 15

19669

Same as 14750 except for unit packing quantity

UNIT PACKAGE: 25



21359

(53879-17020)
Black Nylon

Bumper & Fender Apron U-Nut

Screw Size: M4.8 (#10)
Panel Range: Up to 2mm
Center of Hole to Edge: 10mm
Toyota Celica and Lexus 2000 - On

UNIT PACKAGE: 10



23945

(90467-04023)
Black Nylon

Nylon U-Nut Fender Apron

Screw Size: M4.8 (#10)
Width: 20mm
Length: 28mm
Toyota Camry 2000

UNIT PACKAGE: 25



20956

(90467-05114)
Black Nylon

Bumper & Fender Apron Nylon U-Nut

Screw Size: M5.5 (#12)
Width: 20mm
Length: 36mm
Panel Range: Up to 1mm
Center of Hole to Edge: 14mm
Lexus & Toyota 2000 - On

UNIT PACKAGE: 10



21687

(90467-05138)
Black Nylon

Front Bumper & Fender Liner Nylon U-Nut

Screw Size: M6.3 (#14)
Panel Range: Up to 3mm
Center of Hole to Edge: 14mm
Lexus GX 460, GX 470 & LX 570, Scion tC and Toyota Corolla, FJ Cruiser, Land Cruiser, Matrix, Sequoia, Tacoma, Tundra & 4 Runner 2003 - On

UNIT PACKAGE: 15



21614

(90467-05128)
White Nylon

Rear Bumper & Bumper Stay Nylon U-Nut

Screw Size: M6 (#14)
Panel Range: Up to 2mm
Center of Hole to Edge: 12mm
RAV4 & Yaris 1996 - On

UNIT PACKAGE: 15



25435

(Lexus & Toyota: 90467-06183)
Black Nylon

Interior Cowl Trim Nut

Thread Size: M6-1.0
Head O.D.: 19mm
Head Height: 13mm
Overall Height: 24.5mm
Lexus GX460 2021 - 2010, GX470 2009 - 2003, LX470 2007 - 1998; Toyota 4Runner 2003 - On, FJ Cruiser 2014 - 2007, Land Cruiser 2007 1998, Tacoma 2016 - 2005

UNIT PACKAGE: 15

**TOYOTA AND VOLKSWAGEN & AUDI
CLIPS AND FASTENERS**



25434

(Lexus & Toyota: 90467-06158-C0)
Black Nylon

Interior Cowl Trim Nut

Thread Size: M5-0.8
Flange O.D.: 20mm
Hex Size: 12mm
Height: 21mm

Lexus ES300 2001 – 1993, ES350 2015 – 2013, GS200t 2016, GS300 2019 – 2018, GS350, GS450h 2019 – 2013 & 2011 – 2007, GS430 2007 – 2006, GS460 2011 – 2008, IS300 2005 – 2002, LS500 2018 – On; Scion tC 2010 – 2005; Toyota Avalon 2004 – 1995, Camry 2004 – 2001, Celica 1997 – 1994, Corolla 2019 – 2014, Land Cruiser 2021 – 2008, Prius 2015 – 2010, RAV4 2021 – 2019, Sienna 2003 – 1998, Solara 2003 – 1999

UNIT PACKAGE: 25



14276

(53879-22010)
Black Nylon

**Nylon U-Nut Fender/Wheel
Housing Applications**

Screw Size: #14(1/4")
Width: 20mm
Length: 29mm

Panel Range: Up to 1mm
Center of Hole to Edge: 15mm

UNIT PACKAGE: 15



21615

(90467-A0018, 90467-05081)
Maroon Nylon

**Left & Right Front Bumper
& Bumper Stay Nylon U-Nut**

Screw Size: M6 (#14)

Panel Range: Up to 2mm
Center of Hole to Edge: 12mm
Toyota Avalon, Camry & Solara
and Lexus 2000 – On

UNIT PACKAGE: 15



13225

Plated

U-Type Nut

Screw Size: 4.2mm (#8)

Width: 11mm

Length: 16.5mm

Panel Range: .5mm – 2.5mm
Center of Hole to Edge: 8mm

UNIT PACKAGE: 50

VOLKSWAGEN & AUDI CLIPS AND FASTENERS



22714

(VW: 3C0-837-975)
Black Nylon

Belt Moulding Retainer

Head Size: 8mm x 10mm
Stem Size: 6mm x 8mm
Stem Length: 8mm
Fits into 4mm Secondary Slot
Volkswagen Passat 2006 – On
Tiguan 2017 – 2009

UNIT PACKAGE: 25



25036

(Audi 4H0-825-429-A)
Black Nylon

Fender Apron Clip

Width: 27mm
Overall Height: 11.5mm
Audi A8 Quattro 2018 – 2011;
S8 2018 – 2013

UNIT PACKAGE: 25



22823

(Audi: 8V0-853-585)
Gray Nylon

**Pillar, Rocker, Floor & Exterior Trim
Push-Type Retainer**

Head Size: 9mm x 22mm
Stem Length: 6mm
Fits into 5mm Square Hole
Audi A3 2016 – On

UNIT PACKAGE: 25



22426

(Audi: 8T0-853-909-A)
Black Nylon

Rocker Moulding Clip

Width: 16mm
Length: 40mm
Audi A4, A4 allroad,
A5, S4 & S5 2008 – On

UNIT PACKAGE: 15



21493

(4A0-853-825-A)
White Nylon

Front & Rear Door Moulding Clip

Width: 22mm
Length: 35mm
Audi 1998 – 92

UNIT PACKAGE: 25

VOLKSWAGEN & AUDI CLIPS AND FASTENERS

(Includes SEAT & Skoda)

Sec. 21



22824

(Audi: 8E0-821-989-A)
Black Nylon

Fender Apron Retainer

Overall Width: 14mm
Audi A6, A7, Q3, Q5, Q7, RS5,
RS7, S6, S7, SQ5 & TT
2017 - 2009

UNIT PACKAGE: 15



22825

(VW: 1K0-839-723)
White Nylon

Glass Channel Guide Clip

Head Size: 11.6 x 26.5mm
Stem Length: 20mm
Shoulder Size: 8mm x 20mm
Fits into 10mm Hole
Overall Height: 28mm
Volkswagen Passat 2011 - 2006

UNIT PACKAGE: 50



21508

(191-853-577)
White Nylon

**Door Trim & Scuff Plate
Moulding Clip**

Head Size: 12mm x 15mm
Stem Diameter: 10mm
Stem Length: 19mm
Audi A1 & A2 and VW Golf & Jetta

UNIT PACKAGE: 25



21512

(7L0-839-069)
White Nylon

Rocker Panel Moulding Clip

Width: 10mm
Length: 28.5mm
Stem Length: 11mm
Fits into 10mm Hole
Touareg 2010 - 05

UNIT PACKAGE: 25



21761

(VW: 3C0-853-585,
3C9-827-407, 3C9-827-408)
White Nylon

**Upper Door Cover Strip Scuff
Protection Moulding Clip**

Top Head Size: 13mm x 16mm
Bottom Head Diameter: 14mm
Stem Length: 13mm
Fits into 9mm Hole
Passat, Tiguan & Touareg 2006 - On

UNIT PACKAGE: 25



22414

(VW: 8R0-853-909)
White Nylon

**Door Moulding Clip with
Blue Rubber Grommet**

Top Head Size: 12mm x 12mm
Stem Length: 13mm
Overall Length: 18.5mm
Audi Q3, Q3 Quattro & Q5 and
Volkswagen 2009 - On

UNIT PACKAGE: 25



21395

(1H0-853-585-B)
White Nylon
Blue Rubber Grommet

Door Moulding Clip

Width: 34mm
Length: 38.5mm
Stem Length: 18mm
Audi & VW Cabrio 2002 - 1999

UNIT PACKAGE: 15

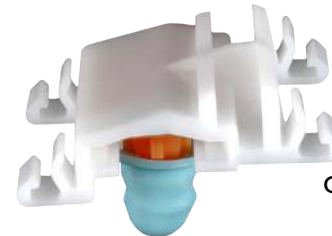

21478

(3A0-853-575)
White & Orange Nylon
Blue Rubber Boot

**Door, Fender &
Quarter Panel Moulding Clip**

Width: 35mm
Length: 38mm
Stem Length: 14mm
Volkswagen 1997 - 90

UNIT PACKAGE: 15



22108

(VW: 4A0-867-276A)
Zinc

Trim Moulding Clip

Overall Height: 16mm
Audi & Volkswagen 2012 - 1998

UNIT PACKAGE: 25



13173

(VW: N14389.3; Volvo: 3104-426)
Metal

Door Panel Clip
Use with Auveco 13206

UNIT PACKAGE: 50



21994

(VW: 3A0-867-301-01C)
Black Nylon

Door Panel Clip

Width: 20mm
Length: 28mm
Stem Diameter: 7.5mm
Stem Length: 6mm
VW, Audi, SEAT & Skoda

UNIT PACKAGE: 15

VOLKSWAGEN & AUDI CLIPS AND FASTENERS (Includes SEAT & Skoda)



22713

(VW: 1K8-837-529)
Black Rubber

Door Bumper

Head Height: 11mm
Stem Length: 6mm
Fits into 6mm Hole

Volkswagen GTI & Golf 2014 - 2010

UNIT PACKAGE: 25



8843

Nylon

Moulding Fastener

Fits 1/2" - 5/8" Mouldings

UNIT PACKAGE: 50



21498

(191-941-142)
White Nylon

Headlight Adjusting Nut

Head Size: 14mm x 18.5mm
Overall Length: 15mm
Fits into 10mm Hole

Audi 100 and VW Golf 1994 - 86

UNIT PACKAGE: 25



22719

(Audi: 8K0-837-199)
Black Nylon

Exterior Door Trim Screw Grommet

Screw Size: M3.5 (#6)
Head Size: 12.6mm x 17.5mm
Stem Length: 12mm
Fits into 9mm x 11mm Hole

Audi A3, A4, Q3, Q5, S3, S4
& SQ5 2017 - On

UNIT PACKAGE: 25



22721

(VW & Porsche: N905-410-01)
Natural Nylon

**Deck Lid & Hood Release
Handle Screw Grommet**

Screw Size: M4.2 (#8)
Head Size: 9.5mm x 9.5mm
Stem Size: 8mm x 9mm
Stem Length: 7.5mm
Fits into 7.5mm Slot

Porsche Cayenne & Macan 2017 - 2003
Volkswagen Beetle, Golf, Golf R,
Jetta, Tiguan 2016 - 2010

UNIT PACKAGE: 50



12735

(GM: 1370853; Chry: 6029501;
VW: 179-813-883)
Nylon

Headlight Bezel Nut

Screw Size: #6
GM & VW 1982 - On
UNIT PACKAGE: 50



14030

(GM: 3997391; VW: 179-813-881)
Black Nylon

Tail Light Nut

Screw Size: #8
GM Astro & Safari 1985-On
Volkswagen

UNIT PACKAGE: 25



21510

(867-809-966, 811-807-557-C)
Black Nylon

Screw Grommet

Screw Size: M4.8 (#10)
Head Diameter: 12mm
Stem Length: 12.5mm
VW & Audi

UNIT PACKAGE: 25



21480

(VW: 165-827-592)
Natural Nylon

Screw Grommet

Screw Size: M4.2 (#8)
Head Diameter: 11mm
Stem Length: 13mm
VW Cabrio, EuroVan, Golf &
Jetta 2003 - 1992

UNIT PACKAGE: 25



20924

(N908-338-01)
Black Nylon

Fender Apron Screw Grommet

Screw Size: M4.2 (#8)
Head Diameter: 15mm
Stem Length: 12mm
Cabrio, Golf, Jetta &
Phaeton 1999 - On

UNIT PACKAGE: 15



20925

(N908-214-01)
Black Nylon

**Bumper & Fender Apron
Screw Grommet**

Screw Size: M4.2 (#8)
Head Diameter: 15mm
Stem Length: 20mm
Audi A4/S4 and A6/S6 1996 - On
VW Cabrio, Golf, Jetta & Phaeton 1999 - On

UNIT PACKAGE: 15

VOLKSWAGEN & AUDI CLIPS AND FASTENERS

(Includes SEAT & Skoda)

Sec. 21



22826
(VW: N-103-180-01)
Natural Nylon

Fender Liner, Grille, Engine Under Cover & Rocker Moulding Screw Grommet

Screw Size: M4.2 (#8)
Head Diameter: 14.5mm
Stem Length: 16mm
Fits into 7.5mm Hole
Overall Height: 18mm
Audi TT 2015 - 2012
Porsche Cayenne 2010 - 2006
Volkswagen Phaeton 2006 - 2004

UNIT PACKAGE: 50



21399
(811-807-577-C)
Black Nylon

Screw Grommet

Screw Size: M4.8 (#10)
Head Diameter: 7mm x 12.5mm
Stem Length: 11mm
Audi Quattro, A4, A6, A8, RS6, S4, S6, TT & 90 and
Volkswagen Golf, Jetta & Passat 2010 - 1990

UNIT PACKAGE: 25



21816
(VW: 6N0-809-966A)
Black Nylon

Screw Grommet

Screw Size: M4.8 (#10)
Head Diameter: 12mm
Stem Length: 15mm
Fits into 6.5mm x 8mm Hole
VW, Audi, SEAT & Skoda

UNIT PACKAGE: 25



22720
(VW: N105-073-01)
Brown Nylon

Bumper & Fender Apron Screw Grommet with Sealer

Screw Size: M4.8 (#8)
Head Diameter: 13mm
Stem Length: 17mm
Fits into 7.5mm x 7.5mm Hole
Audi A3, A4, A5, RS 5, S4
& S5 2015 - 2009
Volkswagen Phaeton 2006 - 2004

UNIT PACKAGE: 25



20933
(357-827-998)
Black Nylon

Front & Rear Door Panel Screw Grommet

Screw Size: M4.8 (#10)
Head Diameter: 16mm
Stem Length: 20mm
Cabrio, Golf, Jetta & Passat 1993 - On

UNIT PACKAGE: 15



21890
(VW: 357-868-143)
Gray Nylon

Screw Grommet

Screw Size: M5.5 (#12)
Head Diameter: 16mm
Stem Length: 23mm
VW, Audi, SEAT & Skoda

UNIT PACKAGE: 25



21987
(VW: N105-168-01; BMW: 51127020321)
White Nylon

Screw Grommet with Black Rubber Sealer

Screw Size: M5.5 (#12)
Head Diameter: 13mm
Stem Length: 16mm
VW, Audi, SEAT, Skoda & BMW

UNIT PACKAGE: 15



21988
(VW: N-106-213-01; Ford: 1725489)
White Nylon

Screw Grommet with Black Rubber Sealer

Screw Size: M4.8 (#10)
Head Diameter: 16mm
Stem Length: 16mm
VW, Audi, SEAT, Skoda & Ford

UNIT PACKAGE: 10



21815
(VW: 4A0-805-163, 8A0-863-821Q)
Black Nylon

Upper & Lower Engine Cover Locking Pin Grommet

Overall Width: 20mm
Overall Height: 16mm
VW, Audi, SEAT & Skoda 1998 - On

UNIT PACKAGE: 25



22094
(VW: 4L0-886-373)
White & Black Nylon

Front & Rear Seat Bottom and Bench Grommet

Top Head Size:
27.6mm x 40mm
Bottom Head Size:
25mm x 37mm
Stem Length: 30mm
Overall Length: 40mm
Audi & Volkswagen Beetle 2013 - 2007

UNIT PACKAGE: 10



22849
(VW: 5Z0-853-695)
Clear Nylon

Corner Cover Grommet With Steel Reinforcement

Head Diameter: 14mm
Stem Length: 5.5mm
Overall Height: 7mm
Fits into 7mm Hole
Volkswagen Beetle 2012 - On

UNIT PACKAGE: 25

VOLKSWAGEN & AUDI CLIPS AND FASTENERS
(Includes SEAT & Skoda)



13206
(113-857-219A)
Black Vinyl

Door Panel & Trunk Liner Plug
Use with Auveco 13173
VW Beetle & Audi

UNIT PACKAGE: 50



22445
(VW: 3C0-853-586)
Black Nylon

Wheel Well Opening Grommet
Head Diameter: 16mm
Stem Length: 15mm
Overall Length: 16.5mm
Audi Q5 & RS5 2015 - 2009
Volkswagen Beetle, Passat,
Tiguan & Touareg 2006 - On

UNIT PACKAGE: 25



25414
(VW: 3B0-867-334)
Cream Nylon

A Pillar Trim Panel Grommet

Head Size: 14mm
Stem Length: 11mm
Overall Height: 12mm
Fits into 8.5mm Hole
Use with Auveco No. 22718
Volkswagen Golf 2020 - 2015,
GTI 2020 - 2006, Jetta 2014 - 2001,
Passat 2010 - 1998, Phaeton 2006 - 2004,
Rabbit 2009 - 2006, Tiguan 2018 - 2009,
Touareg 2010 - 2004

UNIT PACKAGE: 50



21843
(Mercedes-Benz: A901-988-00-25;
VW: 2D1867741)
Black Nylon

Rear Entry Scuff Plate Retaining Pin
Head Size: 15mm x 15mm
Overall Length: 31mm
VW LT Van 2007 - 1987
Mercedes-Benz Sprinter 1995 - On

UNIT PACKAGE: 25



22216
(VW: 6N0-867-276)
White Nylon

Windshield Pillar Trim Clip
Top Head Size: 10mm x 15mm
Bottom Head Size: 17mm x 25mm
Overall Height: 20mm
Volkswagen Beetle, Golf, GTI &
Jetta 2010 - 2003

UNIT PACKAGE: 15



25314
(Audi: 5J0-853-573)
Black Nylon

Wheel Moulding Clip with Sealer
Top Head Diameter: 10mm
Bottom Head Diameter: 18mm
Stem Diameter: 9mm
Stem Length: 17mm
Overall Height: 22mm
Fits into 9mm Hole
Audi e-tron Quattro 2021 - 2019,
Q3 2019 - On, Q5, SQ5 2021 - 2018,
Q8 2020 - 2019, SQ8 2020

UNIT PACKAGE: 25



22235

(Audi: 4F0-825-429A)
Black Nylon

Splash Shield Retaining Clip
Size: 22mm x 23mm
Audi A4, A6, A7, S4, S5, S6,
S7, Q5 & RS5 2008 - On

UNIT PACKAGE: 25



22308

(Audi: 8K0-821-213A)
Natural Nylon

Bumper & Side Air Baffle Retaining Clip
Head Size: 15.3mm x 18.3mm
Overall Height: 20mm
Audi A4, A5, A6, Q3, Q5, RS7,
S4, S5, S6, S7 & SQ5 2015 - On

UNIT PACKAGE: 15



21981

(VW: 1H0-823-717)
Black Nylon

Weatherstrip Retainer
Head Size: 5.5mm x 17mm
Stem Diameter: 5mm
Stem Length: 7mm
VW, Audi, SEAT & Skoda

UNIT PACKAGE: 25



25339

(VW: 3B0-839-723)
Gray Nylon

Door Weatherstrip Clip
Head Size: 5mm x 11mm
Stem Diameter: 6.3mm
Stem Length: 9.5mm
Overall Height: 10.5mm
Fits into 6mm Hole
Volkswagen Golf, Jetta 2011-1999,
Passat 2005-1998, Rabbit 2004

UNIT PACKAGE: 50

VOLKSWAGEN & AUDI CLIPS AND FASTENERS

(Includes SEAT & Skoda)



21980

(VW: 1Z0-837-732A)
Yellow Nylon

Weatherstrip Retainer
Head Size: 5mm x 13mm
Stem Diameter: 5.7mm
Stem Length: 5mm
VW, Audi, SEAT & Skoda

UNIT PACKAGE: 25



21497

(1H0-837-719)
Black Nylon

Weatherstrip Retainer with Clear Grommet
Head Size: 6mm x 15mm
Stem Diameter: 7.5mm
Stem Length: 17mm
Audi A3 and VW Golf, Sharan, Transporter & Corsa

UNIT PACKAGE: 25



25415

(Audi: 8E0-837-485-D)
White Nylon

Door Weatherstrip Retainer with Sealer
Top Head Size: 6.5mm x 16mm
Bottom Head Diameter: 10mm
Stem Diameter: 5mm x 7.5mm
Stem Length: 10mm
Overall Height: 14.5mm
Fits into 6mm Hole

Audi A4 2009 - 2002, RS4 2008 - 2007, S4 2009 - 2004

UNIT PACKAGE: 50



22717

(VW: 6E0-837-732)
Natural Nylon

Interior Door Trim Clip
Top Head Diameter: 6.5mm x 11mm
Bottom Head Diameter: 13.5mm
Stem Diameter: 5.8mm
Stem Length: 8mm
Volkswagen Beetle, CC, Eos, GTI, Passat & Tiguan 2006 - On

UNIT PACKAGE: 25



22711

(VW: 1J0-827-713)
Natural Nylon

Deck Lid Retainer
Head Diameter: 9mm
Stem Size: 4mm x 10mm
Stem Length: 9mm
Fits into 7mm Hole
Volkswagen Beetle, Golf, Golf Alltrack, Golf GTI, Golf SportWagen, Jetta, Passat & Rabbit 2004 - On

UNIT PACKAGE: 50



22718

(VW: 6Q0-867-333)
Black Nylon

Inner Door & Quarter Trim Retainer
Head Diameter: 15mm
Stem Diameter: 5.7mm
Stem Length: 19mm

Audi A3, A7, RS 7, S3, S7 & TT 2012 - On Volkswagen GTI, Golf, Golf Alltrack, Golf R, Golf SportWagen & e-Golf 2015 - On

UNIT PACKAGE: 25



23782

(N90282401, 3096724)

Fender Door Trim Panel Clip
Head Diameter: 19mm
Stem Diameter: 7.3 x 8.3mm
Stem Length: 18mm

Volkswagen Rabbit, GM S10 2004 - On

UNIT PACKAGE: 50



22449

(VW: N90-911-301)
Black Nylon

Interior Trim Panel & Cowl Cover Retainer
Head Diameter: 20mm
Stem Diameter: 8mm
Stem Length: 16mm

Audi A3 & S3 2015 - On
Volkswagen Golf, Jetta & Passat 2012 - On

UNIT PACKAGE: 25



21392

(1H0-819-055-B01C)
Black Nylon

Instrument Panel, Cowl Vent, Defroster Grille & Ducts Retainer

Head Diameter: 23mm
Stem Diameter: 6.5mm
Stem Length: 16mm
Phillips Drive

Audi and Volkswagen Cabrio, Golf & Jetta 2002 - 1993

UNIT PACKAGE: 25



22338

(VW: 3C0-863-559)
Black Nylon

Wheel House Cover Mount & Interior Trim Retainer

Head Diameter: 26mm
Stem Diameter: 7.6mm
Stem Length: 28mm

Volkswagen Passat & CC 2012 - 2006

UNIT PACKAGE: 25



22399

(VW: 6Q0-807-643)
Black Nylon

Rear Bumper Trim Pin Retainer

Head Diameter: 17.5mm
Stem Length: 25mm
Overall Length: 34.3mm

Audi A1, A3, Q5, Q7 & TT and Volkswagen CC, Eos, Golf, Jetta, Passat, Polo, Tiguan, Touran & Transporter 2004 - On

UNIT PACKAGE: 25

VOLKSWAGEN & AUDI CLIPS AND FASTENERS
(Includes SEAT & Skoda)



21885
(VW: 4A0-805-121C)
Black Nylon

Cowl Retaining Pin with Slotted Head
Head Diameter: 25mm
Stem Length: 23mm
VW, Audi, SEAT & Skoda

UNIT PACKAGE: 25



22208
(VW: 4A0-805-121C)
Black Nylon

Splash Shield Slotted Retainer
Head Diameter: 25mm
Stem Length: 24mm
Use with Auveco 21815
Audi A4, A6, A8, RS 4, S4, S6 & S8
and Volkswagen 2011 - 02

UNIT PACKAGE: 15



25260
(VW: 3B0-867-333)
White Nylon

Trim Panel Retainer
Top Head Diameter: 12.5mm
Bottom Head Diameter: 15mm
Stem Diameter: 5.8mm
Stem Length: 15mm
Volkswagen GTI, Rabbit 2009 - 2006, Jetta 2014 - 2001,
Passat 1998 - On, Touareg 2010 - 2004

UNIT PACKAGE: 25



21509
(357-853-575)
White Nylon

Retainer with Gray Grommet
Top Head Diameter: 12mm
Bottom Head Diameter: 18mm
Stem Diameter: 10mm
Stem Length: 16mm
Golf, Jetta, Passat & Scirocco

UNIT PACKAGE: 25



21496
(357-853-585-A)
White Nylon

Trim Panel Retainer with Black Nylon Grommet
Top Head Diameter: 12mm
Bottom Head Diameter: 18mm
Stem Diameter: 10mm
Stem Length: 12mm
Golf & Passat and Audi B3

UNIT PACKAGE: 15



22716
(VW: 4F0-831-719)
Light Gray Nylon

Door Weatherstrip Retainer with Sealer
Top Head Diameter: 13mm
Middle Head Diameter: 13mm
Bottom Head Diameter: 10mm
Stem Diameter: 8mm
Stem Length: 9mm
Fits into 6mm Hole
Audi A6 & S6 2011 - 2005

UNIT PACKAGE: 25



21853
(VW: 7M0-867-299-K, 7M3-867-299;
Land Rover: DYC500020;
Ford: 1008068)
Yellow Nylon

Door Trim Panel Retainer with Sealer
Top Head Diameter: 13mm
Bottom Head Diameter: 17.5mm
Stem Diameter: 10.5mm
Stem Length: 15mm
Land Rover 1997 - On
VW & Audi 1999 - On

UNIT PACKAGE: 25



21819
Yellow Nylon

Retainer
Top Head Diameter: 13mm
Bottom Head Diameter: 17.5mm
Stem Diameter: 10mm
Stem Length: 16mm
VW, Audi, SEAT, Skoda & Ford

UNIT PACKAGE: 25



22417
(Audi: 8U0-853-909)
Blue Nylon

Wheel Arch Opening Moulding Retainer with Sealer
Top Head Diameter: 13.3mm
Bottom Head Diameter: 17mm
Stem Diameter: 9.3mm
Stem Length: 10mm
Audi RS & Q3 and Volkswagen Golf, R32, GTI & Rabbit, 2015 - On

UNIT PACKAGE: 25



21450
(703-867-299)
Black Nylon

Side Panel & Interior Trim Retainer
Top Head Diameter: 13.5mm
Bottom Head Diameter: 18mm
Stem Diameter: 9mm
Stem Length: 14mm
VW 2003 - 1993

UNIT PACKAGE: 25

VOLKSWAGEN & AUDI CLIPS AND FASTENERS (Includes SEAT & Skoda)



21495
(7L5-853-994)
Blue Nylon

Trim Panel Retainer
Top Head Diameter: 13mm
Bottom Head Diameter: 18mm
Stem Diameter: 9mm
Stem Length: 14mm
VW, Audi & Renault

UNIT PACKAGE: 25



13475
(Renault: 8934-201-681;
VW: 175-867-299)
White Nylon

Trim Panel Retainer
Head Diameter: 19mm
Stem Length: 18mm
Stem Diameter: 9mm
AMC-Renault 1984-On
VW 1982-On

UNIT PACKAGE: 50



13179
(481-867-197)
Black Nylon

Trim Panel Retainer
Top Diameter: 14mm
Bottom Diameter: 14mm
Stem Length: 14mm
Stem Diameter: 11mm
VW

UNIT PACKAGE: 50



21494
(171-807-249-A)
Natural Nylon

Trim Panel Retainer
Top Head Diameter: 12mm
Bottom Head Diameter: 18mm
Stem Diameter: 9.5mm
Stem Length: 12mm
VW Golf & Audi 1978 - On

UNIT PACKAGE: 25



20252
(823-867-299)
Black Nylon

Trim Panel Retainer
Top Head Diameter: 14mm
Bottom Head Diameter: 18mm
Stem Diameter: 9mm
Stem Length: 14mm
Corrado, EuroVan, Jetta,
Rabbit & Vanagon 1979 - On

UNIT PACKAGE: 25



25263
(4M0-805-163)
White & Green Nylon

Bumper Cover Retainer
Top Head Diameter: 13mm
Middle Head Diameter: 18mm
Bottom Head Diameter: 14mm
Stem Diameter: 8mm
Stem Length: 19mm
Overall Height: 25mm
Audi Q7 2020 - 2017, Q8 2020 - 2018,
SQ7, SQ8 2020

UNIT PACKAGE: 25



22231
(VW: 1K6-837-200B)
Black Nylon

Door Panel Retainer
Top Head Diameter: 10mm
Middle Head Diameter: 12mm
Bottom Head Diameter: 12mm
Stem Diameter: 8mm
Stem Length: 9mm
VW Golf V, GTI, Jetta & R32 2010 - 1999

UNIT PACKAGE: 25



20341
(3B0-868-243)
Black Nylon

Door Trim Panel Retainer
Head Diameter: 22mm
Stem Length: 10mm
Fits into 10mm Hole
Beetle, Golf, Jetta & Passat 1998 - On

UNIT PACKAGE: 25



21398
(6K0-868-243-C)
Black Nylon

Trim Panel Retainer
Top Head Diameter: 22mm
Bottom Head Diameter: 18mm
Stem Length: 12mm
Fits into 8mm Hole
Audi and Volkswagen Touareg 2010 - 2004

UNIT PACKAGE: 25



21144
(8E0-868-243)
Black Nylon

Interior Trim Panel Retainer with Sealer
Top Head Diameter: 21.5mm
Bottom Head Diameter: 27mm
Stem Diameter: 11mm
Stem Length: 19mm
Audi A4 & S4, Avant, Cabriolet,
Quattro & Sedan Wagon, 2005 - On

UNIT PACKAGE: 25

VOLKSWAGEN & AUDI CLIPS AND FASTENERS

(Includes SEAT & Skoda)



21894

(VW: 5X0-867-299)
Black Nylon

Trim Panel Retainer

Top Head Diameter: 22mm
Bottom Head Diameter: 22mm
Stem Diameter: 9.3mm
Stem Length: 14mm
VW, Audi, SEAT & Skoda

UNIT PACKAGE: 15



21708

(VW: 7L6-868-243)
Black Nylon

Door Trim Panel Retainer with Sealer

Head Diameter: 22.5mm
Stem Diameter: 9mm
Stem Length: 12mm
Audi A5, A6, A7, S5, S6 & S7 and
VW Beetle, Cabrio, Golf,
Gti, Jetta, Passat & Touareg 2004 - On

UNIT PACKAGE: 15



25340

(VW: 3CN-868-243)
White & Black Nylon

Door Trim Panel Retainer with Sealer

Top Head Diameter: 21.5mm
Middle Head Diameter: 16mm
Bottom Head Diameter: 19.5mm
Stem Diameter: 7.5mm
Stem Length: 11mm
Overall Height: 23mm
Volkswagen GTI, Taos 2022; ID.4 2021-On

UNIT PACKAGE: 15



22442

(Audi: 8V0-868-243)
Black Nylon

Door Trim Panel Retaining Clip

Size: 25mm x 26mm
Overall Height: 12.5mm
Audi A3, S3, Q7 & TT 2015 - On

UNIT PACKAGE: 25



22827

(VW: 3AA-868-243-A)
Black Nylon

Door Trim Panel Retainer with Rubber Seal

Top Head Size: 10mm x 18.5mm
Bottom Head Diameter: 21mm
Stem Length: 12mm
Fits into 12mm Hole
Volkswagen Atlas, Beetle, e-Golf,
GTI, Golf, Golf Alltrack, Golf R,
Golf Sportwagen, Passat
& Tiguan 2016 - On

UNIT PACKAGE: 15



21415

(1H0-868-243-B)
Tan and White Nylon

Adjustable Door Trim Panel Retainer

Head Diameter: 28.5mm
Stem Diameter: 9.5mm
Stem Length: 11mm
Overall Length: 31mm
Golf 2002 - 1993

UNIT PACKAGE: 25



21997

(VW: 6N0-868-243A)
Black & White Nylon

Trim Panel Retainer

Top Head Diameter: 28mm
Bottom Head Diameter: 19mm
Stem Diameter: 10mm
Stem Length: 12mm
VW, Audi, SEAT & Skoda

UNIT PACKAGE: 10



22204

(Audi: 4D0-867-299D)
Black Nylon

Door Trim Panel Retainer

Top Head Size: 14mm x 14mm
Bottom Head Diameter: 12mm
Stem Length: 9mm
Fits into 9mm Hole
Audi A8, A8 Quattro & S8 2003 - 1997

UNIT PACKAGE: 15



21145

(1H5-863-849-A-01C)
Black Nylon

Hood Insulation Retainer

Head Size: 20mm x 25mm
Stem Length: 13mm
Fits into 12mm Hole
Audi A4, A6, Cabriolet, Quattro, S4 & S6
and Volkswagen Beetle, Golf, Jetta, Passat,
Rabbit & Touareg 1998 - On

UNIT PACKAGE: 15



20187

(Mercedes: 000-990-34-92;
BMW: 51-16-1-881-149;
VW: N-102-593-01)
Black Nylon

Radiator Housing Push-Type Retainer

Head Diameter: 10mm
Stem Length: 10mm
Fits into 6mm Hole
Body Styles 116, 123, 124, 126, 129, 140, 170, 201,
208 & 210 1974 - On
BMW & VW
UNIT PACKAGE: 15

VOLKSWAGEN & AUDI CLIPS AND FASTENERS

(Includes SEAT & Skoda)



22238

(VW: N-905-369-01)
Black Nylon

Bumper, Hood, Interior Trim & Quarter Panel Push-Type Retainer

Head Diameter: 10mm
Stem Length: 11mm
Fits into 5mm Hole
Audi 90, A4 & S4 and VW Beetle,
Golf & Jetta 1993 - On
UNIT PACKAGE: 25



21391

(N038-550-1)
Dark Gray Nylon

Bumper, Exterior Trim, Fender, Quarter Panel & Wheel Opening Push-Type Retainer

Head Diameter: 12mm
Stem Length: 11mm
Fits into 8mm Hole
Audi and Volkswagen EuroVan, Golf,
Jetta & Passat 2003 - 1985

UNIT PACKAGE: 25



22830

(VW: N-105-835-01-9B9)
Black Nylon

Bumper, Fender, Interior Trim & Seat Release Handle Push-Type Retainer

Top Head Diameter: 17mm
Bottom Head Diameter: 13mm
Stem Length: 12mm
Fits into 8mm Hole
Audi A3, A4, A5, A8, Allroad, Q3, RS5,
S3, S4, S5 & S8 2009 - On
Volkswagen Beetle 2013 - On

UNIT PACKAGE: 25



21990

(VW: 6L0-121-136A)
Black Nylon

Push-Type Retainer

Head Diameter: 15mm
Stem Length: 8mm
Fits into 7mm Hole
VW, Audi, SEAT & Skoda

UNIT PACKAGE: 15



22421

(VW: N10-700-901)
Black Nylon

Front Suspension Shield Push-Type Retainer

Head Diameter: 15mm
Stem Length: 11mm
Fits into 5mm Hole
Audi A3 & Q7 and Porsche 911 &
Cayenne and Volkswagen Golf, Jetta,
Passat, Eos & Phaeton 2009 - On

UNIT PACKAGE: 25



22397

(VW: 1K0-837-199B; 8L3837199B;
811807447; 8L4833052;
8L4833051 8L837199)
Black Nylon

Front Door Push-Type Retainer

Top Head Diameter: 10mm
Bottom Head Size: 10mm x 22mm
Stem Length: 12mm
Fits into 7mm Hole
Audi A3, A4, A6, A7, A8, RS 4,
RS 6 & TT and Volkswagen Golf &
Jetta 2011 - 1996

UNIT PACKAGE: 15



19195

(161-867-299-01C)
Black Nylon

Push-Type Retainer

Head Diameter: 16mm
Stem Length: 12mm
Fits into 8mm Hole
VW Golf & Jetta 1997 - 93

UNIT PACKAGE: 25



22759

(VW: 5K0-837-975A)
Natural Nylon

Window Regulator Push-Type Retainer

Head Diameter: 16mm
Stem Length: 14mm
Fits into 7mm Hole
Volkswagen GTI, Golf
& Golf R 2014 - 2010

UNIT PACKAGE: 15



22280

(VW: 3C0-853-934)
Black Nylon

Splash Shield & Rocker Moulding Push-Type Retainer

Head Diameter: 15mm
Hex: 8mm (with 4mm Allen Drive)
Stem Length: 10mm
Fits into 8mm Hole
Volkswagen CC 2009 - On
Passat 2010 - 2006

UNIT PACKAGE: 25



22420

(Audi: 8K0-868-307)
Black Nylon

Fender End Plate Push-Type Retainer

Head Diameter: 16mm
Stem Length: 12mm
Fits into 10.5mm Hole
Audi A4 allroad, A5, A7, Q7, RS5,
RS7, S5 & S7 2009 - On

UNIT PACKAGE: 25

VOLKSWAGEN & AUDI CLIPS AND FASTENERS

(Includes SEAT & Skoda)



22829
(VW: N-911-829-01)
Black Nylon

Rocker Moulding Push-Type Retainer
Head Diameter: 18mm
Stem Length: 13mm
Fits into 10mm Hole
Volkswagen 2000 - On

UNIT PACKAGE: 15



21479
(701-867-299)
Gray Nylon

Front Bumper & Interior Trim Push-Type Retainer
Allen Head Drive: 3mm
Head Diameter: 18.5mm
Stem Length: 11mm
Fits into 9mm Hole
VW Jetta & Passat 1999 - On

UNIT PACKAGE: 25



22828
(VW: WHT-005-263)
Black Nylon

Bumper Diffuser Push-Type Retainer
Head Size: 18mm x 25mm
Stem Length: 9mm
T15 Torx® Drive
Fits into 8mm Slot
Volkswagen e-Golf, GTI, Golf, Golf Alltrack & Passat 2017 - 2012

UNIT PACKAGE: 15



22722
(VW: WHT-004-994)
Black Nylon

Interior Pillar Push-Type Retainer
Head Diameter: 22mm
Stem Length: 11mm (Including Pin)
Fits into 7.5mm Hole
Volkswagen Jetta 2011 - On

UNIT PACKAGE: 25



22101
(Audi: 4D0-807-300)
Black Nylon

Bumper, Fender & Hood Insulation Push-Type Retainer
Head Diameter: 22mm
Stem Length: 12mm
Fits into 7.5mm Hole
Audi A4, A5, A8, Q3, Q5 & S8 1997 - On

UNIT PACKAGE: 15



22095
(Audi: N90-229-301)
Black Nylon

Hood Insulation Push-Type Retainer
Head Diameter: 22mm
Stem Length: 13mm
Fits into 8mm Hole
Audi & Volkswagen 1986 - On

UNIT PACKAGE: 25



21251
(6Q0-868-243)
Black & White Nylon

Trim Panel Push-Type Retainer with Sealer
Head Diameter: 22.5mm
Stem Length: 7mm (Excluding the Pin)
Fits into 8mm Hole
Golf, Jetta, Passat, Phaeton, Rabbit & Tiguan 2004 - On

UNIT PACKAGE: 15



21482
(1H0-867-199-A)
Black Nylon

Push-Type Retainer
Head Diameter: 24mm
Stem Length: 13mm
Fits into 9mm Square Hole
Passat 1999 - 90

UNIT PACKAGE: 25



21887
(VW: 8K0-805-121)
Black Steel

Phillips Drive Cowl & Radiator Support Splash Shield Guide Fastener

Head Diameter: 16mm
Stem Diameter: 5mm
Stem Length: 19mm
VW, Audi A4 2020 - 2017, A5 2017 - 2008, A6, A7 Quattro 2018 - 2012, A8 Quattro 2018 - 2011, allroad 2016 - 2013, Q3 2018 - 2015, Q5 2019 - 2009, Q7 2019 - 2017, RS5 2015 - 2013, RS7 2018 - 2014, S4 2020 - 2010, S5 2017 - 2008, S6, S7, S8 2018 - 2013, SQ5 2019 - 2014, SEAT & Skoda

UNIT PACKAGE: 10



21889
(VW: 8D0-805-121)
Zinc

Slotted Drive Cowl Fastener
Head Diameter: 18mm
Stem Diameter: 7mm
Stem Length: 18mm
VW, Audi, SEAT & Skoda

UNIT PACKAGE: 10

VOLKSWAGEN & AUDI CLIPS AND FASTENERS

(Includes SEAT & Skoda)



21886

(VW: 8E0-805-121A)
Black Steel

Slotted Drive Cowl Fastener with Gasket

Head Diameter: 18.5mm
Stem Diameter: 7mm
Stem Length: 12mm
VW, Audi, SEAT & Skoda

UNIT PACKAGE: 15

22715

(VW: 3D0-898-501-B-B41)
Black Nylon



Assembled

Floor Mat Retainer Set (2 Pieces)

Head Diameter: 40mm
Assembled Hole: 12mm x 21mm
Fits 27mm Mat Hole
Volkswagen Beetle, CC, EOS, Golf, Jetta, Passat, R32, Tiguan & Touareg 2012 - 1998

UNIT PACKAGE: 25



22918

(VW: 443-857-857-B-4PK)
Black Nylon

Seat Belt Stop Button

Diameter: 16mm
2 Piece Set

Audi A3, A4, A4 allroad, A5 Sportback, A6, A7, A8, Q3, Q5, Q7, Q8, RS5 Sportback, S3, S4, S5 Sportback, SQ5 & e-tron Quattro 2019 - On
Volkswagen Arteon, Atlas, CC, Cabrio, Eos, GTI, Golf, Golf Alltrack, Golf R, Golf Sportwagen, Jetta, Passat, Phaeton, Rabbit, Tiguan & Touareg 1993 - On

UNIT PACKAGE: 25



22411

(VW: 3D0-864-851-B41)
Black Nylon

Floor Mat Retaining Clip

Top Head Size: 12mm x 20mm
Bottom Head Diameter: 35mm
Stem Length: 14mm
Volkswagen Golf, R32, GTI, Rabbit, Jetta & Passat 2016 - 2005

UNIT PACKAGE: 25



22441

(VW: 3D0-864-812-A-B41)
Black Nylon

Floor Mat Stay Retainer

Head Diameter: 30mm
Stem Diameter: 9mm
Stem Length: 14mm
Overall Length: 24.5mm
Audi & Volkswagen Beetle, Golf & Passat 2007 - 1999

UNIT PACKAGE: 25



22447

(VW: 6Q0-853-147)
Black Nylon

Carpet, Door Sill Plate, Floor Mat, Quarter Panel Trim, Scuff Plate & Wheel House Retainer

Top Head Size: 12mm x 14mm
Overall Length: 21mm
Audi A3 & A4 2013 - 2005
Volkswagen Golf Alltrack, Golf, Jetta, Passat & Rabbit 2005 - On

UNIT PACKAGE: 25



22444

(VW: 8E0-864-229-9B9)
Black Nylon

Carpet Retaining Cap

Diameter: 30mm
Height: 15mm
Audi & Volkswagen Tiguan 2012 - On

UNIT PACKAGE: 25

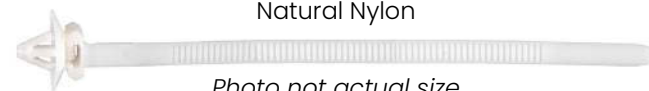

21305

(Not Available from O.E.M.)
Natural Nylon

Photo not actual size

Push-Mount Cable Strap

Overall Length: 156mm (6-1/8")
Strap Width: 5mm (3/16")
Snaps into 6.3mm (1/4") Hole
Maximum Bundle Diameter: 40mm (1-9/16")
European Makes & Universal

UNIT PACKAGE: 25



22594

(VW: 6N0-129-355)
Black Nylon

Bumper Clamping Washer

Outside Diameter: 18mm
Thickness: 1mm
Hole Diameter: 5.5mm
Audi Q3, Q5, SQ5 & T 2017 - 2000
Volkswagen CC, Passat & Touareg 2010 - 2004

UNIT PACKAGE: 25



22954

(Audi: 3W0-971-838)
Gray Nylon

Photo not actual size

Cable Tie

Length: 200mm (8")
Max. Bundle Diameter: 55mm (2-3/16")
Fits into 7mm (9/32") Hole
Audi Q5 2016 - 2013; R8 2012 - 2011; S5 2012 - 2008

UNIT PACKAGE: 25

VOLKSWAGEN & AUDI CLIPS AND FASTENERS
(Includes SEAT & Skoda)



21513
(N90-335-006)
Dacromet
Splash Shield & Wheel Well Push-On Retainer
Stud Size: 5mm
Outer Diameter: 30mm
VW & Audi
UNIT PACKAGE: 25

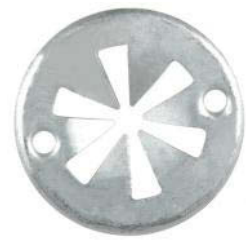

21485
(N90-796-501, N90-796-502)
Dacromet
Radiator Support & Splash Shield Push-On Retainer
Stud Size: 5mm
Outer Diameter: 30mm
VW 2006 - 1999
UNIT PACKAGE: 25



22098
(VW: 4F0-805-163)
Zinc
Sub Frame Clip
Width: 13mm
Length: 27mm
Audi A6 & S6 and
Volkswagen 2005 - On
UNIT PACKAGE: 10



22116
(VW: 1J6-867-276)
Zinc Finish
Door Trim Clip
Overall Height: 22.5mm
Width at Bottom Base: 13.5mm
Audi & VW 2004 - On
UNIT PACKAGE: 25



21818
(VW: 4A0-867-276;
Mercedes: 001-991-76-70)
Black Spring Steel
Pillar Trim Clip
Overall Height: 22mm
VW, Audi, SEAT & Skoda;
Mercedes Sprinter 2010 - On
UNIT PACKAGE: 25



13216
Zinc
U-Nut
Screw Size: 4.8mm
Panel Range: .9mm - 2mm
Center of Hole to Edge: 8mm
UNIT PACKAGE: 25



25261
(Audi: WHT-005-296)
Zinc
Fender Apron & Under Cover U-Nut
Screw Size: M4.8-1.61 (#10)
Panel Range: 1.5mm-2.5mm
Center of Hole To Edge: 11mm
Width: 16mm
Length: 19mm
Audi A3, S3 2015 - On, A4 2017 - On, A5, S4, S5 2018 - On,
A6, A7, A8, e-tron, RS5 2019 - On, Q3 2018 - 2015,
S6, S7, S8 2020 - On, TT, TTS 2016 - On
UNIT PACKAGE: 25



22260
(Audi: 8K0-805-922A)
Zinc
Lower Skid Plate Cover & Radiator Support U-Type Nut
Panel Range: 2.2mm - 5.5mm
Center of Hole to Edge: 13mm
Width: 19.3mm
Length: 23.5mm
Audi A4, A5, A6, A7, A8, Q5, S4,
S5, S6 & S8 2012 - 2008
UNIT PACKAGE: 15



25227
(Audi & Volkswagen: 8D0-805-960)
Zinc
Engine Under Cover Retainer U-Nut
Width: 25mm
Length: 24.5mm
Overall Height: 9mm
Use with Auveco 21888 or 21889
Audi A4, A4 Quattro 2009 - 1996, A6,
A6 Quattro 2011 - 1998, Allroad Quattro 2005 - 2001,
R8 2015 - 2008, RS4 2008 - 2007, S4 2009 - 2000,
S6 2011 - 2002; Volkswagen Passat 2005 - 1998
UNIT PACKAGE: 25

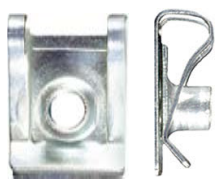

22113
(BMW: 51127070202;
VW: N90168602)
Zinc Finish
Metric Extruded U-Nut
Screw Size: M5-.8
Panel Range: .45mm - 1.5mm
Center of Hole to Edge: 11.5mm
BMW 1999 - 1992
VW 1993 - On
UNIT PACKAGE: 25



22850
(VW: WHT-000-713)
Black Nylon
Under Cover & Fender Liner Nut
Thread Size: M4.2 (#8)
Flange O.D.: 30mm
Hex Size: 10mm
Height: 16mm
Volkswagen Eos 2016 - 2007
Golf 2015 - 2010
Golf Sportwagen 2015
UNIT PACKAGE: 25

VOLKSWAGEN, AUDI, & VOLVO CLIPS AND FASTENERS

Sec. 21



22418

(VW: N90-757-901, N903-521-01)
Black Nylon

Fender Liner Nylon Nut

Screw Size: M4.8 (#10)
Hex Size: 10mm
Flange Diameter: 22mm
Overall Height: 11mm

Audi A7, A8, Q3, RS7, S7 & S8 and
Volkswagen Beetle, Golf, GTI, Passat,
Tiguan & Touareg 2010 - On

UNIT PACKAGE: 25



22291

(VW: N-910-189-01)
Black Nylon

Front Bumper Support Retainer Nut

Thread Size: M6.3-1.81
Hex Size: 10mm

Flange Diameter: 16.3mm
Overall Height: 11.3mm
Beetle, CC, Eos, GTI, Golf,
Jetta & Rabbit 2003 - On

UNIT PACKAGE: 25



21456

(171-201-969)
Black Nylon

Moulding Nylon Flange Nut

Stud Size: 5mm
Hex: 10mm

Flange Diameter: 18.5mm
Overall Height: 10.5mm
Audi A8, S8 & 90 2003 - 1993

UNIT PACKAGE: 25



12595

(GM: 11503752, 11505329;
VW: N90100001)
Phosphate

Free Spinning Washer Nut

Screw Size: M6-1.0
Washer Outer Diameter: 16mm
Hex: 10mm

UNIT PACKAGE: 25



11404

(N14-4003)
Plain Steel

Manifold Stud
M8-1.25 x 35mm

UNIT PACKAGE: 25

VOLVO CLIPS AND FASTENERS



12637

(591-740)
Nylon

**Body Side
Moulding Clip**

UNIT PACKAGE: 50



22138

(30753487)
Metal &
White Nylon

Pillar & Exterior Trim Glass Weatherstrip Clip

Overall Length: 49mm
Volvo XC60 2008 - On

UNIT PACKAGE: 10

22137

(30753556)
Metal & White Nylon



Pillar & Exterior Trim Glass Weatherstrip Clip

Overall Length: 60mm
Volvo V70 & XC70 2008 - On

UNIT PACKAGE: 10

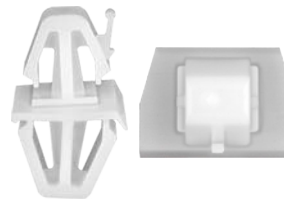

22340

(30808521)
White Nylon

Rocker Panel Moulding Clip

Overall Height: 24mm
Volvo S40 2004 - 2000

UNIT PACKAGE: 15



22556

(Volvo: 31214496)
White Nylon

Rocker Panel Moulding Clip

Top Head Size: 13mm x 22mm
Bottom Head Size: 14mm x 22mm

Stem Length: 18mm

Fits into 8mm Hole
Volvo S40, S80, V70, XC60
& XC70 2008 - On

UNIT PACKAGE: 15



13173

(VW: N14389.3;
Volvo: 3104-426)

**Metal
Panel Clip**

UNIT PACKAGE: 50

VOLVO AND UNIVERSAL EUROPEAN CLIPS & FASTENERS



22554
(Volvo: 9182822)
Black Nylon

Hood Insulation Retainer
Head Size: 25mm x 30mm
Stem Length: 15mm
Volvo C30, C70, S40, S60, S70,
S80, S90, V50, V60, V70,
V90, XC60, XC70
& XC90 1998 - On

UNIT PACKAGE: 15



19904
(9133417-7)
Black Nylon

**Rocker Panel
Push-Type Retainer**
Head Diameter: 16mm
Stem Length: 14mm
Fits into 9mm Hole
850 Series 1994 - On

UNIT PACKAGE: 15



25117
(Volvo: 8659732)
Orange Nylon

Fender Flare Retainer
Top Head Diameter: 15mm
Bottom Head Diameter: 16mm
Stem Diameter: 8mm
Stem Length: 11mm
Overall Height: 15.5mm
Volvo S60, V60 2018 - 2016, V70 2010 - 2001,
XC60 2013 - 2009, XC70 2016 - 2003,
XC90 2014 - 2003

UNIT PACKAGE: 25



22765
(Volvo: 3541113)
Black Nylon

**Bumper, Windshield Trim,
Trunk Trim & Mud Flap
Push-Type Retainer**
Head Diameter: 20mm
Stem Length: 8.3mm (Excluding Pin)
Fits into 8mm Hole
Volvo 940 & 960 1993 - 1991
C30, C70, S40, S60, S80, S90, V50, V60,
V70, V90, XC60, XC70 & XC90 2000 - On

UNIT PACKAGE: 25



13230
(Mercedes 000-990-03-92;
Volvo 947-098)
Black Nylon

Push-Type Retainer
Head Diameter: 10mm
Stem Length: 7mm
Fits into 5mm Hole

UNIT PACKAGE: 50



20407
(9133073-8)
Black Nylon

**Hood Insulation &
Radiator Seal Push-Type Retainer**
Head Size: 8mm x 25mm
Stem Length: 10mm
Fits into 5mm Hole
850, 940, 960, S80, S90 & V90 1991 - On

UNIT PACKAGE: 25



21859
(Mercedes-Benz: 000-990-29-92,
000-990-60-92, 001-990-16-92,
114-990-01-92; Opel: 1104882, 1719245;
Volvo: 9133417, 1268642)
Black Nylon

Push-Type Retainer
Head Diameter: 16mm
Stem Length: 11mm
Fits into 8mm Hole
Mercedes-Benz, Opel & Volvo 1985 - On

UNIT PACKAGE: 15



13220
(Mercedes 000-994-09-45;
Volvo 946-418;
Opel 20-72-175)
Plated

U-Type Nut
Screw Size: 6.3mm
Panel Range: .7mm-1.5mm
Center of Hole to Edge: 13mm

UNIT PACKAGE: 50

UNIVERSAL EUROPEAN FASTENERS



19248
(1268176-3)
Black Nylon

**Bumper Cover
Push-Type Retainer**
Head Diameter: 16mm
Stem Length: 14mm
Fits into 6mm Hole
740 & 760 1993 - On

UNIT PACKAGE: 15



16132
Black Nylon

Trim Panel Retainer
Head Diameter: 19mm
Stem Length: 20mm
Fits into 8mm Hole

UNIT PACKAGE: 25



9965
(3944866, 1244839)

Universal Moulding Fastener
Across Flats: 1-1/4"
Hole Size: 5/16"
GM

UNIT PACKAGE: 25

12971

Same as 9965 except for unit package quantity

UNIT PACKAGE: 10



2943
(4759145, 4761842, 4779348)

**Front and Rear Fender and
Door Peak Moulding Fastener**
Across Flats: 1-1/4"
Hole Size: 3/8"
Left Arm: 9/16"
GM

UNIT PACKAGE: 50

12966

Same as 2943 except for unit package quantity

UNIT PACKAGE: 15



23702

Moulding Clip with Sealer
General Purpose
GM & Other Makes

UNIT PACKAGE: 25



23964

Moulding Fastener with Barrel Nut
GM
Stud Size: 1/8"

UNIT PACKAGE: 15



2744
(Chry: 1624705, 6010093)

Moulding Fastener
Bolt: #10-24 x 3/4"
Plate Length: 3/4"
Plate Width: 5/16"

UNIT PACKAGE: 50

12959

Same as 2744 except for unit package quantity

UNIT PACKAGE: 15



12962
(GM: 4689929, 4778814)

Moulding Fastener
Bolt: #10-24 x 3/4"
Plate Length: 3/4"
Plate Width: 5/16"

UNIT PACKAGE: 15

WARNING: Reproductive Harm & Cancer
www.P65Warnings.ca.gov



19626
(Ford: 358560;
Chry: 1560058, 6010029;
GM: 568792, 574355, 1165051)

Moulding Fastener
Bolt: #10-24 x 3/4"
Plate Length: 1"
Plate Width: 1/2"
Replaces Auveco 2514

UNIT PACKAGE: 25

19627

Same as 19626 except for unit package quantity

UNIT PACKAGE: 15

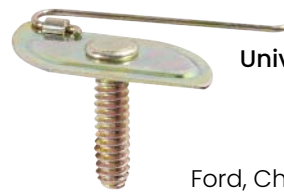

23589

Universal Moulding Retainer
Bolt: #10-24
Length: 5/8"
Plate Width: 19/32
Plate Length: 1-1/4"
Ford, Chrysler, GM & General Purpose

UNIT PACKAGE: 50



20175
(4637277, 4730773)

Moulding Fastener
#10-24 x 3/4"
Plate Length: 1-5/8"
Plate Width: 11/16"
Replaces Auveco 2821

UNIT PACKAGE: 25



2789
(GM: 575411, 4723818)

Moulding Fastener
Bolt: #10-24 x 5/8"
Plate Length: 1-5/8"
Plate Width: 9/16"

UNIT PACKAGE: 50

12961

Same as 2789 except for unit package quantity

UNIT PACKAGE: 15

WARNING: Reproductive Harm & Cancer
www.P65Warnings.ca.gov



2619
(Chry: 6000705, 6013029;
GM: 3722635)

Moulding Fastener
Bolt: #10-24 x 3/4"
Plate Length: 1-11/32"
Plate Width: 1/2"

UNIT PACKAGE: 50

12958

Same as 2619 except for unit package quantity

UNIT PACKAGE: 15



2752
(GM: 3744999;
Chry: 1758099,
6000720, 6010046)

Moulding Fastener
Bolt: #10-24 x 3/4"
Plate Length: 1-25/32"
Plate Width: 9/16"

UNIT PACKAGE: 50

12960

Same as 2752 except for unit package quantity

UNIT PACKAGE: 15



19807
(GM: 4676189)

Moulding Fastener
Bolt: #10-24 x 3/4"
Plate Length: 2-17/32"
Plate Width: 11/16"
Replaces Auveco 2820

UNIT PACKAGE: 15



19378
Zinc

Universal Moulding Fastener
Bolt: #10-24 x 3/4"
Plate: 2-1/2" x 3/4"

Break off plate at 1/16" perforations to fit moulding
Replaces Auveco 2356
Use with Auveco Hex Nut 730

UNIT PACKAGE: 25



8843
Nylon

Moulding Fastener
For 1/2"-5/8" Mouldings

UNIT PACKAGE: 50



8447
(GM: 4886720, 4417599)
Nylon

Front & Rear Door Moulding Fastener
For 1/2" to 5/8" Moulding

UNIT PACKAGE: 50



8398
(GM: 4853108)
Nylon

Front & Rear Door and Quarter Panel Moulding Fastener
For 3/4" to 1" Moulding

UNIT PACKAGE: 25



8386
(GM: 4877001)
Nylon

Rear Fender Lower Moulding Fastener
For 1" to 1-1/4" Moulding

UNIT PACKAGE: 25



8400
Nylon
Moulding Fastener
For 1-1/4" to 1-3/4" Moulding

UNIT PACKAGE: 25

Photos not actual size

Rod End Ball Joints • Male

• **Bearing Raceway:**
Locked in by annular groove-trunnion design. Made of fiber reinforced nylon.

• **Spherical Ball:**
Precision made from selected low carbon steel-case hardened - file hard. Plated plus dichromate treated for corrosion resistance.

• **Outer Member (Housing):**
Low carbon steel, plated plus dichromate treated for corrosion resistance.

• **Left Hand Thread:**
Available with left hand thread in most sizes. Marked for easy user identification.

Only available fully assembled.

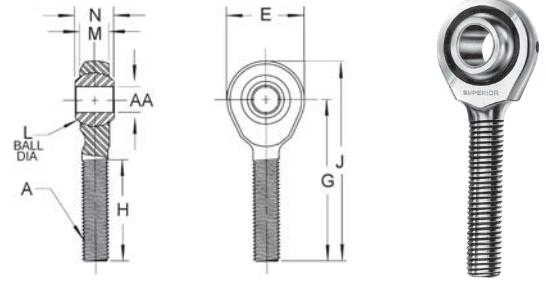

Auveco Part No.	Thread Size (A)	AA	E	G	H	J	L	M	N	Unit Pkg.	
12268	10-32	.189	.625	1.250	.750	1.562	.438	.250	.312	1	R
12269		.191								1	L
12270	1/4-28	.250	.750	1.562	1.000	1.937	.516	.281	.375	1	R
12271		.252								1	L
12021	5/16-24	.3125	.875	1.875	1.250	2.312	.625	.344	.437	1	R
12272		.3145								1	L
12022	3/8-24	.375	1.000	1.937	1.250	2.437	.719	.406	.500	1	R
12273		.377								1	L
12485	7/16-20	.4395	1.125	2.125	1.312	2.687	.812	.437	.562	1	R
		.4375									
12023	1/2-20	.500	1.312	2.437	1.500	3.094	.938	.500	.625	1	R
12274		.502								1	L
12024	5/8-18	.625	1.500	2.625	1.625	3.375	1.125	.562	.750	1	R
12486	3/4-16	.752	1.750	2.875	1.750	3.750	1.312	.687	.875	1	R
		.750									

Rod End Ball Joints • Female

• **Bearing Raceway:**
Locked in by annular groove-trunnion design. Made of fiber reinforced nylon.

• **Spherical Ball:**
Precision made from selected low carbon steel-case hardened - file hard. Plated plus dichromate treated for corrosion resistance.

• **Outer Member (Housing):**
Low carbon steel, plated plus dichromate treated for corrosion resistance.

• **Left Hand Thread:**
Available with left hand thread in most sizes. Marked for easy user identification.

Only available fully assembled.

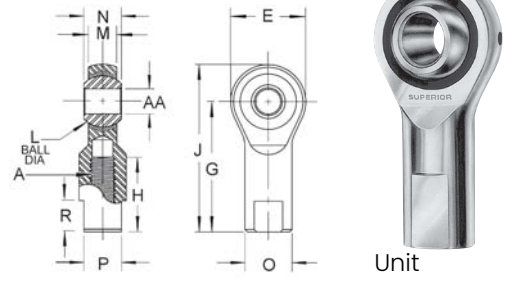

Auveco Part No.	Thread Size (A)	AA	E	G	H	J	L	M	N	O	P	R	Unit Pkg.	
12025	10-32	.189	.625	1.062	.562	1.375	.438	.250	.312	.406	.312	.406	1	R
12276		.191											1	L
12026	1/4-28	.250	.750	1.312	.750	1.687	.516	.281	.375	.469	.375	.406	1	R
12277		.252											1	L
12027	5/16-24	.3125	.875	1.375	.750	1.812	.625	.344	.437	.500	.437	.500	1	R
12278		.3145											1	L
12028	3/8-24	.375	1.000	1.625	.937	2.125	.719	.406	.500	.687	.562	.562	1	R
12279		.377											1	L
12487	7/16-20	.4395	1.125	1.812	1.032	2.375	.812	.437	.562	.750	.625	.625	1	R
		.4375												
12029	1/2-20	.500	1.312	2.125	1.187	2.781	.938	.500	.625	.875	.750	.687	1	R
12280		.502											1	L
12281	5/8-18	.625	1.500	2.500	1.500	3.250	1.125	.562	.750	1.000	.875	.875	1	R
12488	3/4-16	.752	1.750	2.875	1.562	3.750	1.312	.687	.875	1.125	1.000	1.000	1	R
		.750												

WARNING: ALL ITEMS ON PAGE Reproductive Harm & Cancer www.P65Warnings.ca.gov

Photos not actual size

Rod End Ball Joints • Male with Stud

• Bearing Raceway:
Locked in by annular groove-trunnion design. Made of fiber reinforced nylon.

• Spherical Ball:
Precision made from selected low carbon steel-case hardened - file hard. Plated plus dichromate treated for corrosion resistance.

• Outer Member (Housing):
Low carbon steel, plated plus dichromate treated for corrosion resistance.

• Left Hand Thread:
Available with left hand thread in most sizes. Marked for easy user identification.

Only available fully assembled.

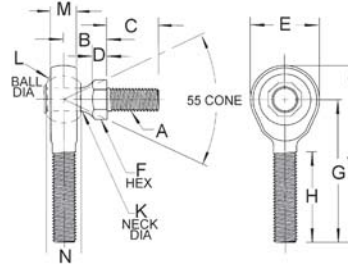

Auveco Part No.	Thread Size (A)	B	C	D	E	F	G	H	J	K	L	M	N	Unit Pkg.	
12290	10-32	.437	.437	.156	.625	.312	1.250	.750	1.562	.189	.438	.250	.312	1	R
12292	1/4-28	.469	.562	.156	.750	.375	1.562	1.000	1.937	.250	.516	.281	.375	1	R
12293														1	L
12030	5/16-24	.531	.687	.187	.875	.437	1.875	1.250	2.312	.312	.625	.344	.437	1	R
12031	3/8-24	.625	.875	.218	1.000	.500	1.937	1.250	2.437	.375	.719	.406	.500	1	R
12295														1	L
12032	1/2-20	.875	1.125	.312	1.312	.625	2.437	1.500	3.094	.500	.938	.500	.625	1	R

Rod End Ball Joints • Female with Stud

• Bearing Raceway:
Locked in by annular groove-trunnion design. Made of fiber reinforced nylon.

• Spherical Ball:
Precision made from selected low carbon steel-case hardened - file hard. Plated plus dichromate treated for corrosion resistance.

• Outer Member (Housing):
Low carbon steel, plated plus dichromate treated for corrosion resistance.

• Left Hand Thread:
Available with left hand thread in most sizes. Marked for easy user identification.

Only available fully assembled.

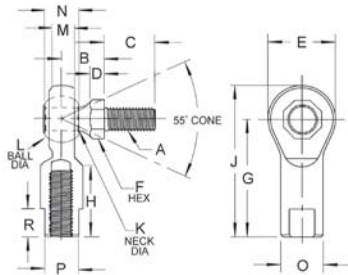

Auveco Part No.	Thread Size (A)	B	C	D	E	F	G	H	J	K	L	M	N	O	P	R	Unit Pkg.	
12034	10-32	.437	.437	.156	.625	.312	1.062	.562	1.375	.189	.438	.250	.312	.406	.312	.406	1	R
12283																	1	L
12035	1/4-28	.469	.562	.156	.750	.375	1.312	.750	1.687	.250	.516	.281	.375	.469	.375	.406	1	R
12284																	1	L
12036	5/16-24	.531	.687	.187	.875	.437	1.375	.750	1.812	.312	.625	.344	.437	.500	.437	.500	1	R
12285																	1	L
12037	3/8-24	.625	.875	.218	1.000	.500	1.625	.937	2.125	.375	.719	.406	.500	.687	.562	.562	1	R
12286																	1	L
12491	7/16-20	.844	1.062	.312	1.125	.625	1.812	1.032	2.375	.437	.812	.437	.562	.750	.625	.625	1	R
12038	1/2-20	.875	1.125	.312	1.312	.625	2.125	1.187	2.781	.500	.938	.500	.625	.875	.750	.687	1	R
12288	5/8-18	1.00	1.125	.375	1.500	.750	2.500	1.500	3.250	.625	1.125	.562	.750	1.00	.875	.875	1	R

⚠ WARNING: ALL ITEMS ON PAGE Reproductive Harm & Cancer www.P65Warnings.ca.gov

Photos not actual size

Damper Control Swivels

The units are made from low carbon steel and are plated and dichromate treated for corrosion resistance. The set screws are made of low carbon steel, plated and dichromate treated for corrosion resistance.

Set screws are case hardened.
A rubber disc is used in the assembly.

Only available fully assembled

Thread Size	Damper Control Swivels			
	Auveco Part No. w/o Nut & Washer	Unit Pkg.	Auveco Part No. with Nut & Washer	Unit Pkg.
1/4-28 x 9/16"	12303	2	12047	3
1/4-20 x 9/16"	12305	2	12049	3

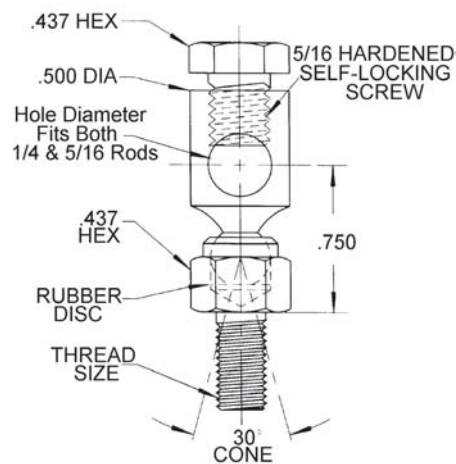

Lightweight Ball Joint Assemblies

Materials of construction: Made of low carbon steel.
Units are plated and dichromate treated for corrosion resistance. A rubber disc is used.

Only available fully assembled.

Auveco Part No.	Unit Pkg.	G.M.C. Part No.	A	B	C	D	E	F
21533	2	443773	1/4-28	2-3/32	9/16	7/16	5/16	9/16

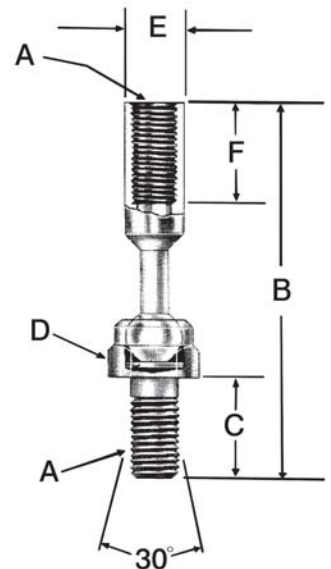

"Flat Top" with Rubber Grommet



Low Carbon steel, case hardened
 Zinc plated with clear dichromate treated
 Rubber grommet seal to protect against contaminants
 Temperature Range: -30°F - 250°F (-34°C - 121°C)

Only available fully assembled.

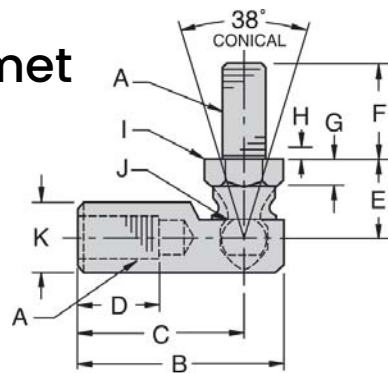

Auveco Part No.	A (in)	B (in)	C (in)	D (in)	E (in)	F (in)	G (in)	H (in)	I (in)	J (in)	K (in)	Wrench Size	Unit Pkg.
13580	10-32	1.156	.875	.469	.359	.438	.094	.062	.312	.177	.375	.312	2 R
12039	1/4-28	1.219	.969	.500	.469	.562	.125	.094	.375	.193	.437	.375	3 R
12040	5/16-24	1.406	1.125	.562	.531	.687	.156	.094	.437	.232	.500	.437	3 R
13590													2 L
12041	3/8-24	1.687	1.375	.750	.687	.875	.187	.094	.500	.287	.625	.500	1 R
12042	7/16-20	2.375	1.937	1.125	.875	1.125	.250	.125	.625	.412	.750	.625	1 R

Quick Disconnect

"Key Hole" design on retaining sleeve insures positive alignment of sleeve with ball cavity.



Materials of construction:
 Body and ball are of low carbon steel, with ball studs case hardened.
 All components except stainless steel spring are plated and yellow dichromate treated for greater corrosion resistance.

Only available fully assembled.

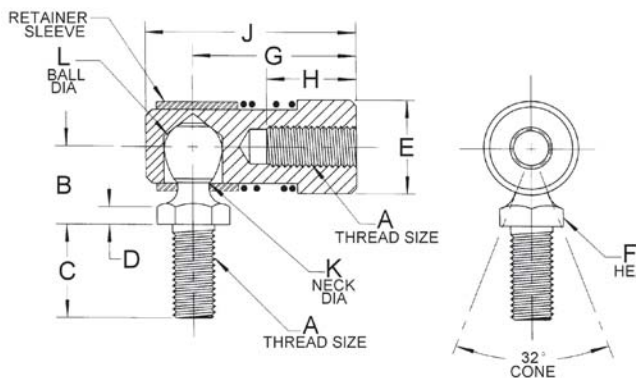

Auveco Part No.	A	B	C	D	E	F	G	H	J	K	L	Unit Pkg.
12044	1/4-28	15/32	9/16	1/8	9/16	3/8	31/32	17/32	1-1/4	.192	.347	2
12045	5/16-24	17/32	11/16	5/32	5/8	7/16	1-1/8	19/32	1-29/64	.224	.405	2
13610	3/8-24	11/16	7/8	3/16	3/4	1/2	1-3/8	13/16	1-3/4	.273	.493	1

Disconnecting

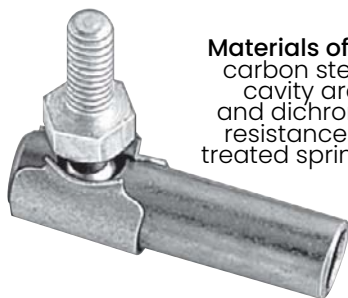

Materials of construction: Made of low carbon steel. Both ball stud and ball cavity are case hardened. Plated and dichromate treated for corrosion resistance. The retaining clip is heat treated spring steel, plated for corrosion resistance

Only available fully assembled.

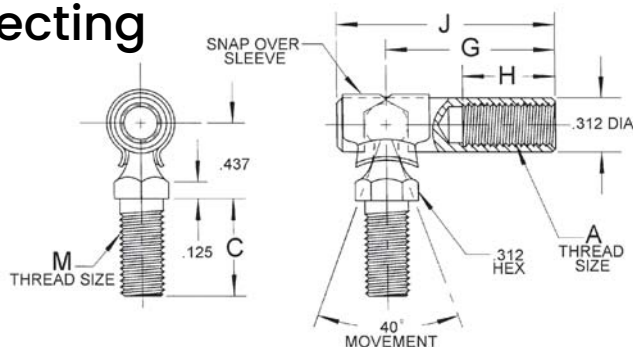

Auveco Part No.	A	C	G	H	J	M	Unit Pkg.
13599	10-32NF	7/16	7/8	31/64	1-5/32	10-32NF	2
13601	10-32NF	9/16	7/8	31/64	1-5/32	1/4-28UNF	2
13600	1/4-28UNF	9/16	31/32	17/32	1-1/4	1/4-28UNF	2

WARNING: ALL ITEMS ON PAGE Reproductive Harm & Cancer www.P65Warnings.ca.gov

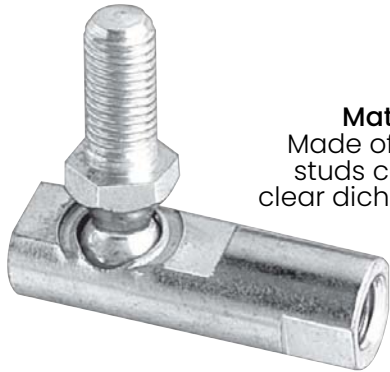

"Flat Top"

Materials of construction:
Made of low carbon steel with ball studs case hardened. Plated and clear dichromate treated for corrosion resistance.

Only available fully assembled.

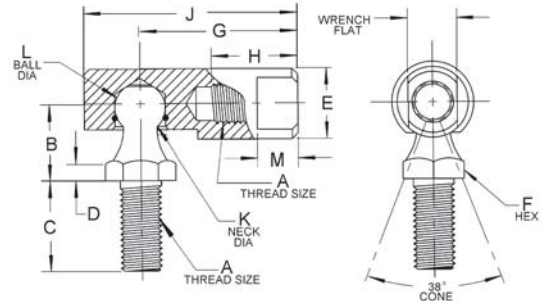

Auveco Part No.	A	B	C	D	E	Wrench Size	F	G	H	J	K	L	Unit Pkg.
13581	10-32	7/16	7/16	1/8	3/8	5/16	5/16	7/8	15/32	1-5/32	.177	.301	2 R
13582	1/4-28	15/32	9/16	1/8	7/16	3/8	3/8	31/32	17/32	1-5/16	.208	.347	2 R
13584	5/16-24	17/32	11/16	5/32	1/2	7/16	7/16	1-1/8	19/32	1-9/16	.250	.405	2 R
9869	3/8-24	11/16	7/8	3/16	5/8	1/2	1/2	1-3/8	13/16	1-13/16	.289	.493	5 R
13587	1/2-20	7/8	1-1/8	1/4	3/4	5/8	5/8	1-15/16	1-1/8	2-1/2	.375	.618	1 R

WARNING: ALL ITEMS IN CHART Reproductive Harm & Cancer www.P65Warnings.ca.gov

YOKE ENDS

Zinc finished Drop Forged Yoke Ends • Adjustable

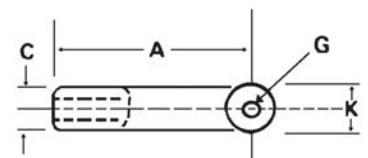
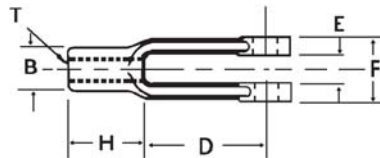

Auveco Part No.	"T" Tap Size	Dimensions in Inches									
Part No.	Size	A	B	C	D	E	F	G	H	K	Pkg.
10737	1/4-28	2	7/16	7/16	1-1/4	9/32	5/8	1/4	3/4	1/2	10
10788	1/4-28	2	7/16	7/16	1-1/4	9/32	5/8	1/4	3/4	1/2	2
10738	5/16-24	2-1/4	1/2	1/2	1-7/16	11/32	3/4	5/16	13/16	19/32	10
10789	5/16-24	2-1/4	1/2	1/2	1-7/16	11/32	3/4	5/16	13/16	19/32	2
10739	3/8-24	2-1/2	5/8	5/8	1-5/8	7/16	7/8	3/8	7/8	11/16	10
10790	3/8-24	2-1/2	5/8	5/8	1-5/8	7/16	7/8	3/8	7/8	11/16	2
10740	7/16-20	2-7/8	23/32	23/32	1-7/8	1/2	1	7/16	1	13/16	10
10791	7/16-20	2-7/8	23/32	23/32	1-7/8	1/2	1	7/16	1	13/16	2
10741	1/2-20	3	13/16	13/16	1-7/8	9/16	1-1/8	1/2	1-1/8	15/16	10
10792	1/2-20	3	13/16	13/16	1-7/8	9/16	1-1/8	1/2	1-1/8	15/16	2
10742	5/8-18	4-15/16	1-1/16	1-1/16	3-11/16	11/16	1-3/8	5/8	1-1/4	1-3/16	10
10793	5/8-18	4-15/16	1-1/16	1-1/16	3-11/16	11/16	1-3/8	5/8	1-1/4	1-3/16	2



Spring Action Hose Clamps

Spring Steel • Heat Treated Phosphate and Paint

Auveco Part No.	Hose O.D.	Color	Max. Dia. Clamp in Free Position	Width	Unit Pkg.
12682	3/8"	Black	.321	5/16"	100
12683	7/16"	Green	.405	5/16"	100
12684	1/2"	Red	.460	5/16"	100
12685	9/16"	Black	.520	5/16"	100
12686	5/8"	Olive	.583	5/16"	100
12689	3/4"	Black	.645	3/8"	100

Crimp Type Hose Clamp Tool

18448

Photo not actual size

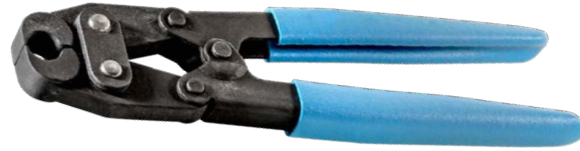

For installing and removing Auveco Crimp Type Hose Clamps 18436-18447

UNIT PACKAGE: 1

WARNING: ALL ITEMS IN CHART Reproductive Harm & Cancer www.P65Warnings.ca.gov

Crimp Type Hose Clamps

Zinc Plated

Photos not actual size

- For low pressure applications such as automotive, appliance, industrial machinery, etc.
- Easy to apply
- Simply slide on and clamp
- Sizes for all Hoses
- Ideal for Mass Production
- Clamps Tight
- Clamps Quickly
- Only one simple motion needed
- "Full Round" Clamping Pressure
- No gap areas to leak
- Low profile-out of the way
- Avoids Hose cutting and abrasion



Position clamp on hose

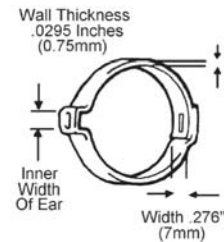

Auveco Part No.	Nominal Size	Inches		MM		Inner Width of Ear		Unit Pkg.
		Closed	Open	Closed	Open	Inches	MM	
18436	3/8"	.350	.414	8.9	10.5	.197	5	25
18437	7/16"	.381	.444	9.7	11.3	.197	5	25
18438	15/32"	.394	.486	10.4	12.3	.197	6	25
18439	1/2"	.453	.524	11.4	13.3	.236	6	25
18440	35/64"	.472	.551	11.9	14.0	.256	6.5	25
18441	9/16"	.496	.571	12.6	14.5	.236	6	25
18442	5/8"	.543	.618	13.8	15.7	.236	6	25
18443	11/16"	.594	.669	15.1	17.0	.236	6	25
18444	23/32"	.618	.728	15.7	18.5	.354	9	25
18445	3/4"	.669	.779	17.0	19.8	.354	9	25
18446	7/8"	.779	.890	19.8	22.6	.354	9	25
18447	1"	.898	1.008	22.8	25.6	.354	9	25



Constant Tension Band Hose Clamps

For Heater & Radiator Hoses
 1074 Spring Steel • Black OEM Finish
 Conforms to SAE J1508 & GM 6298M
 Rated at 30 P.S.I.

Auveco Part No.	Clamping Range	Band Width	Unit Pkg.
18127	15.2mm - 18.5mm (5/8" - 23/32")	15mm (19/32")	10
18128	17.8mm - 20.0mm (23/32" - 25/32")	15mm (19/32")	10
18129	22.0mm - 26.0mm (7/8" - 1")	15mm (19/32")	10
22997	27.0mm - 31.5mm (1-1/16" - 1-1/4")	15mm (19/32")	5
18132	37.2mm - 44.5mm (1-15/32" - 1-3/4")	15mm (19/32")	5



Wire Type Hose Clamps

To install and remove wire type hose clamps use Auveco Tool 20902 (See page 849)

Auveco Part No.	Hose Size O.D.	Unit Pkg.
5354	9/16"	50
5357	3/4"	50
17086	13/16"	50
5358	15/16"	50
16604	2"	10



9324

Mini Clamp
 Stainless Steel Band with
 Double Plated Hex Head Steel Screw
 Band Width: 5/16"
 Minimum Range 1/4" - Maximum Range 5/8"

UNIT PACKAGE: 10

WARNING: Reproductive Harm & Cancer
www.P65Warnings.ca.gov



10221

Mini Clamp
 Stainless Steel Band with Double
 Plated Slotted Head Steel Screw
 Band Width: 5/16"
 Minimum Range 1/2" - Maximum Range 7/8"

UNIT PACKAGE: 10

WARNING: Reproductive Harm & Cancer
www.P65Warnings.ca.gov



Hex Slotted Screw-Worm Gear Type-Hose Clamps

Stainless Steel
 Band Saddle Screw Housing
 300 Series Stainless (Non-Corrosive)
 Screw is 400 Series (Magnetic) Stainless

Auveco. Part No.	Inside Std. Size	Clamp Range Min.-Max	Hose I.D. 3/16" Wall	Fits Plastic Pipe Size	Band Width	Unit Pkg.
9584	8	7/16" - 1"	5/16" to 1/2"	1/2" to 9/16"	9/16"	10
9585	10	1/2" - 1-1/8"	3/8" to 5/8"	1/2" to 3/4"	9/16"	10
9586	12	1/2" - 1-1/4"	5/8" to 3/4"	1/2" to 3/4"	9/16"	10
18483	16	3/4" - 1-1/2"	3/4" to 7/8"	1" to 1-1/4"	9/16"	10
9587	20	3/4" - 1-3/4"	1" to 1-1/4"	1" to 1-1/4"	9/16"	10
9588	24	1" - 2"	1-1/4" to 1-1/2"	1" to 1-1/2"	9/16"	10
9589	28	1-5/16" - 2-1/4"	1-1/4" to 1-3/4"	1-1/4" to 1-1/2"	9/16"	10
9590	32	1-9/16" - 2-1/2"	1-1/2" to 2"	1-1/2" to 2"	9/16"	10
9591	36	7/8" - 2-3/4"	1-3/4" to 2-1/4"	1-1/2" to 2"	9/16"	10
9592	40	1-1/8" - 3"	2" to 2-1/2"	2" to 2-1/2"	9/16"	10
9593	48	1-5/8" - 3-1/2"	2-1/4" to 3"	2-5/8" to 3"	9/16"	10
9594	52	1-7/8" - 3-3/4"	2-13/16" to 3-3/4"	3"	9/16"	10
9595	72	3-1/8" - 5"	3-3/4" to 4-1/2"		9/16"	10
9596	88	4-1/4" - 6"	4" to 5-1/2"	4"	9/16"	10
9597	96	4-3/4" - 6-1/2"	4-1/2" to 6"		9/16"	10
9598	104	5" - 7"	5-7/8" to 6-1/2"	6"	9/16"	10



Hex Slotted Screw-Worm Gear Type-Hose Clamps

Partial Stainless Steel
300 Series Stainless Steel Band and Saddle
Plated Screw and Housing

Auveco Part No.	Inside Std. Size	Clamp Range Min.-Max	Hose I.D. 3/16" Wall	Fits Plastic Pipe Size	Band Width	Unit Pkg.
5347	10	1/2" - 1-1/8"	3/8" to 5/8"	1/2" to 3/4"	9/16"	10
5348	12	1/2" - 1-1/4"	5/8" to 3/4"	1/2" to 3/4"	9/16"	10
18482	16	3/4"-1-1/2"	3/4" to 7/8"	1" to 1-1/4"	9/16"	10
5349	20	3/4" - 1-3/4"	1" to 1-1/4"	1" to 1-1/4"	9/16"	10
5350	28	1-5/16" - 2-1/4"	1-1/4" to 1-3/4"	1-1/4" to 1-1/2"	9/16"	10
5351	32	1-9/16" - 2-1/2"	1-1/2" to 2"	1-1/2" to 2"	9/16"	10
5352	36	7/8" - 2-3/4"	1-3/4" to 2-1/4"	1-1/2" to 2"	9/16"	10
9357	48	1-5/8" - 3-1/2"	2-1/4" to 3"	2-1/4" to 2-3/4"	9/16"	10
9599	52	1-7/8" - 3-3/4"	2-13/16" to 3-3/4"	3"	9/16"	10
9358	72	3-1/8" - 5"	3-3/4" to 4-1/2"		9/16"	10
9600	88	4-1/4" - 6"	4" to 5-1/2"	4"	9/16"	10
9601	96	4-3/4" - 6-1/2"	4-1/2" to 6"		9/16"	10

WARNING: ALL ITEMS IN CHART Reproductive Harm & Cancer www.P65Warnings.ca.gov

European Style Hose Clamps

DIN 3017 • Stainless Steel Band & Housing • Zinc Plated Steel Screw



Unique off-set non-welded design of the housing provides resistance to over-tightening damage to the hose. The short housing saddle gives a smooth underside ensuring high sealing efficiency. These clamps are original equipment on both domestic and import vehicles. They are particularly suited for fuel, vacuum, water, emission and heater hoses and can be used with silicone hoses.

Auveco Part No.	Clamping Range	Hex Size	Band Width	Unit Pkg.
16868	8mm-12mm (5/16"-1/2")	6mm*	8mm (5/16")	10
16869	10mm-16mm (3/8"-5/8")	6mm*	8mm (5/16")	10
16870	12mm-18mm (1/2"-3/4")	6mm*	8mm (5/16")	10
16871	8mm-16mm (5/16"-5/8")	6mm	9mm (11/32")	10
16872	12mm-20mm (1/2"-3/4")	6mm	9mm (11/32")	10
16873	16mm-25mm (5/8"-1")	6mm	9mm (11/32")	10
16874	20mm-32mm (3/4"-1-1/4")	6mm	9mm (11/32")	10
16875	25mm-40mm (1"-1-5/8")	6mm	9mm (11/32")	10
16876	30mm-45mm (1-3/16"-1-3/4")	6mm	9mm (11/32")	10
16877	32mm-50mm (1-1/4"-2")	6mm	9mm (11/32")	10
16878	40mm-60mm (1-5/8"-2-3/8")	6mm	9mm (11/32")	10
19252	50mm-70mm (1-31/32"-2-3/4")	6mm	9mm (11/32")	10
19253	60mm-80mm (2-3/8"-3-1/8")	6mm	9mm (11/32")	10
19254	70mm-90mm (2-3/4"-3-9/16")	6mm	9mm (11/32")	10

*Phillips Hex Drive

German Style Hose Clamps

Stainless Steel Band & Housing • Zinc Plated Stainless Steel Screw



- Deliver high clamping force
- Rolled edges minimize hose abrasion
- Non-slotted band eliminates hose extrusion
- Suited for fuel, vacuum, water, emission and heater hoses

Used in applications for automotive, recreational vehicles, heavy equipment and marine

Auveco Part No.	Clamping Range	Hex Size	Band Width	Unit Pkg.
25302	8mm - 16mm (5/16" - 5/8")	7mm	9mm (11/32")	10
25303	12mm - 20 mm (1/2" - 3/4")	7mm	9mm (11/32")	10
25305	16mm - 25mm (5/8" - 1")	7mm	9mm (11/32")	10
25304	20mm - 32mm (3/4" - 1-1/4")	7mm	9mm (11/32")	10
25298	25mm - 40mm (1" - 1-5/8")	7mm	9mm (11/32")	10
25299	30mm - 45mm (1-3/16" - 1-3/4")	7mm	9mm (11/32")	10
25301	35mm - 50mm (1-3/8" - 2")	7mm	9mm (11/32")	10
25300	40mm - 60mm (1-5/8" - 2-3/8")	7mm	9mm (11/32")	10
25306	50mm - 70mm (2" - 2-3/4")	7mm	9mm (11/32")	10
25307	60mm - 80mm (2-3/8" - 3-1/8")	7mm	9mm (11/32")	10
25308	70mm - 90mm (2-3/4" - 3-1/2")	7mm	9mm (11/32")	10



Photo not actual size

16879

Flexible Nut Driver
For 6mm Hex
Fits Auveco Hose Clamps
16868 - 16878 and 19252 - 19254

UNIT PACKAGE: 1



Type "G" Miniature Hose Clamp

These clamps fit all standard automotive fuel injection hoses.
Approved for all O.E.M. applications
Zinc Plated

Auveco Part No.	Clamp Range Min.-Max	Hose I.D.	Band Width	Unit Pkg.
16766	8mm-9.5mm 5/16"-13/32"	5/32"	9mm (11/32")	10
16767	9.5mm-11.5mm	7/32" 3/8"-15/32"	9mm (11/32")	10
15860	10.5mm-12.5mm 7/16"-1/2"	1/4"	9mm (11/32")	10
15861	12.5mm-14.5mm	5/16" 1/2" - 19/32"	9mm (11/32")	10
15862	13.5mm-15.5mm 17/32"-5/8"	3/8"	9mm (11/32")	10
23984	15.5mm-16.5mm		9mm (11/32")	15
21256	15mm-17.5mm	3/8" 19/32"-11/16"	9mm (11/32")	10



Natural Nylon Tubing Clamps

Auveco Part No.	Hole Dia.	Width	Tube Dia.	Unit Pkg.
15525	3/16"	3/8"	1/8"	50
15526	3/16"	3/8"	3/16"	50
9246	3/16"	3/8"	1/4"	25
9247	3/16"	3/8"	5/16"	25
9248	3/16"	3/8"	3/8"	25
9249	3/16"	3/8"	1/2"	25
9251	3/16"	1/2"	3/4"	25



**Steel Clamps
with Neoprene
Jacket**

Zinc Plated

UNIT PACKAGE: 10

Auveco Part No.	Tube Size	Band Width	Mounting Hole Diameter
20502	1/4"	1/2"	17/64"
20503	3/8"	1/2"	17/64"
20504	1/2"	1/2"	17/64"
20505	5/8"	1/2"	17/64"
20506	3/4"	1/2"	17/64"
20507	7/8"	1/2"	17/64"
20508	1"	1/2"	17/64"
20509	1-1/4"	1/2"	17/64"
20510	1-1/2"	1/2"	17/64"
20511	1-3/4"	1/2"	17/64"
20512	2"	1/2"	17/64"



**Aluminum
Tubing Clamps
With Neoprene Jacket**

Auveco Part No.	Hole Dia.	Width	Tube Dia.	Unit Pkg.
17361	1/4"	1/2"	1/4"	15
17362	1/4"	1/2"	5/16"	15
17363	1/4"	1/2"	3/8"	15
17364	1/4"	1/2"	1/2"	15
17365	1/4"	1/2"	5/8"	15
17366	1/4"	1/2"	3/4"	15
17367	1/4"	1/2"	7/8"	15
17368	1/4"	1/2"	1"	15
22170	1/4"	1/2"	1-1/4"	10
22171	1/4"	1/2"	1-1/2"	10
22172	1/4"	1/2"	2"	10

WARNING: ALL ITEMS IN CHART Cancer www.P65Warnings.ca.gov



Insulated "Half" Clamps

Galvanized

Coated with Black Vinyl (1/32" Thick)

Auveco Part No.	Inside Diameter	Hole Diameter	Center to Center	Hole Center to End	Top of Radius to Base	Gauge	Width	Unit Pkg.
10608	3/16"	7/32"	7/16"	1/4"	5/32"	.032	1/2"	25
10609	1/4"	7/32"	1/2"	1/4"	7/32"	.048	1/2"	25
10610	5/16"	9/32"	17/32"	5/16"	9/32"	.048	5/8"	25
10611	3/8"	9/32"	9/16"	5/16"	11/32"	.048	5/8"	25
10613	1/2"	9/32"	11/16"	5/16"	15/32"	.060	5/8"	25
10614	5/8"	9/32"	13/16"	5/16"	9/16"	.060	5/8"	25
10615	3/4"	9/32"	7/8"	5/16"	11/16"	.060	5/8"	25

WARNING: ALL ITEMS IN CHART Cancer www.P65Warnings.ca.gov



**Steel Uninsulated
Closed Clamps Furnished Open**

Galvanized

UNIT PACKAGE: 25

Auveco Part No.	D Inside Diameter	H Hole Diameter	L Center to Center	W Width	E Hole Center to End	F Gap	G Gauge	S Slot
9389	1/4"	9/32"	1/2"	1/2"	5/16"	1/32"	.032"	3/8"
9391	3/8"	9/32"	9/16"	1/2"	5/16"	1/32"	.032"	3/8"

Steel Insulated Closed Clamps

Furnished Open • Galvanized • Coated with Black Vinyl (1/32" Thick)

UNIT PACKAGE: 25

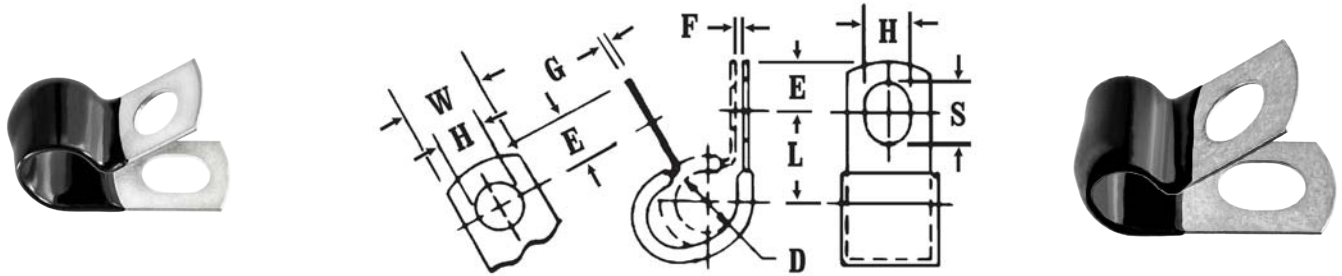

	D	H	L	W	E	F	G	S
Auveco Part No.	Inside Diameter	Hole Diameter	Center to Center	Width	Hole Center to End	Gap	Gauge	Slot Length

Small Hole Clamps

17087	3/16"	9/32"	1/2"	1/2"	5/16"	1/32"	.032"	3/8"
9381	1/4"	9/32"	17/32"	1/2"	5/16"	1/32"	.032"	3/8"
9382	5/16"	9/32"	9/16"	1/2"	5/16"	1/32"	.032"	3/8"
9383	3/8"	9/32"	19/32"	1/2"	5/16"	1/16"	.032"	3/8"
9384	1/2"	9/32"	21/32"	1/2"	5/16"	1/16"	.048"	3/8"
9385	5/8"	9/32"	23/32"	1/2"	5/16"	1/16"	.048"	3/8"
9386	3/4"	9/32"	25/32"	1/2"	5/16"	1/16"	.048"	3/8"
9387	7/8"	9/32"	27/32"	1/2"	5/16"	1/16"	.048"	3/8"
9388	1"	9/32"	29/32"	1/2"	5/16"	1/16"	.048"	3/8"

Large Hole Clamps

10598	1/4"	13/32"	21/32"	3/4"	7/16"	1/32"	.032"	1/2"
10599	5/16"	13/32"	11/16"	3/4"	7/16"	1/32"	.032"	1/2"
10600	3/8"	13/32"	23/32"	3/4"	7/16"	1/16"	.032"	1/2"
10601	1/2"	13/32"	25/32"	3/4"	7/16"	1/16"	.048"	1/2"
10602	5/8"	13/32"	27/32"	3/4"	7/16"	1/16"	.048"	1/2"
10603	3/4"	13/32"	29/32"	3/4"	7/16"	1/16"	.048"	1/2"
10604	7/8"	13/32"	31/32"	3/4"	7/16"	1/16"	.048"	1/2"
10605	1"	13/32"	1-1/32"	3/4"	7/16"	1/16"	.048"	1/2"
10606	1-1/4"	13/32"	1-5/32"	3/4"	7/16"	1/16"	.048"	1/2"
10607	1-1/2"	13/32"	1-9/32"	3/4"	7/16"	1/16"	.048"	1/2"
17588*	1-3/4"	13/32"	1-13/32"	3/4"	7/16"	1/16"	.048"	1/2"
17589*	2"	13/32"	1-9/16"	3/4"	7/16"	1/16"	.048"	1/2"

*Unit Package: 10

 **WARNING:** ALL ITEMS ION PAGE Cancer www.P65Warnings.ca.gov

SEALER

Photos not actual size



Automotive Body Sealer Natural Color

1001

11 fluid ounces per Cartridge
(White Colored Cartridge)

UNIT PACKAGE: 12 Cartridges

For use as a water and dust seal on exterior and interior body surfaces. New improved formula allows for a longer open time so it can be tooled for several minutes after being applied. Cures to a firm abrasion resistant seal with no cracks or peeling. Can be air dried or force dried and then painted within 30 minutes

Stands up on vertical surfaces and won't crack even in large seams. Ideal for drip molds, interior trunk welds, exterior body seam welds and many other body seam areas. Possesses excellent flexibility properties so it will not harden or become brittle.

Excess sealer and smears can be cleaned up with a suitable solvent before sealer dries. Sealer surface accepts all paints and must be painted. Shelf life is 6 months.

⚠️ WARNING: Cancer - www.P65Warnings.ca.gov



Seam-n-Joint Sealer Natural Color

1002

11 fluid ounces per Cartridge
(Green Colored Cartridge)

UNIT PACKAGE: 12 Cartridges

Premium quality, fast setting seam-n-joint sealer with superior adhesion for interior and exterior automotive applications (except windshields) Its self-leveling qualities make it an excellent sealer on quarter panel seams, trunk seams, wheel house seams, floor seams, cowl seams and door skins.

1002 smooths easily so rough edges and fingerprints disappear. Possesses superior flexibility properties, eliminating any cracking or peeling. Skin time is 1-2 minutes. Can be painted with any type of paint in 30-60 minutes. Shelf life is 6 months.

Distributors: Auveco 1001 and 1002 can be combined for price breaks and prepaid freight.

⚠️ WARNING: Cancer - www.P65Warnings.ca.gov

Rubber Squeegee



24514

SQ-2000,
SQ-2000-100

Rubber Squeegee

Size: 2" x 3"
Thickness: 3/16"

Photo not actual size

An economical extruded squeegee suitable for applying putty, cold solder and sanding operations

UNIT PACKAGE: 100

FIXITQUIK EPOXY PUTTY

Photos not actual size

Hardens like Steel in 20 Minutes

FixitQuik will plug or seal practically anything that leaks, it will patch holes and cracks. Excellent for rebuilding or fabricating parts and an all purpose adhesive for metals, wood, glass, masonry, ceramics and many plastics. It can also be drilled, tapped, filed, sanded and painted like metal. Sets steel hard in 20 minutes.



1007
1 Tube (4 oz.)

⚠ WARNING: Reproductive Harm - www.P65Warnings.ca.gov

Hints for Use

- FixitQuik adheres to most surfaces. Best results will be achieved if area is first roughened by sanding or filing to clean and prepare surface.
 - Starts to harden 2 minutes after mixing. Repair should be in place before hardening starts.
- A smooth finish can be obtained by rubbing with wet finger or damp cloth before hardening begins.
- Can be drilled, filed, tapped sanded and machined after one hour of curing (hardening).
 - Can be painted immediately, even before full hardening.
 - Usable under water. Mix as usual and use the polyethylene wrapper, so material will not stick to hands as the FixitQuik is being forced onto the wet surface.
 - Not recommended for use on polyethylene and polypropylene.
- Wash hands thoroughly with soap and water after using.

Mixing Directions

1. Break off required portion of material.
2. Twist and knead until uniform color is achieved leaving no streaks.
3. Apply at once to surface. (2 minute work life).
4. Remove excess before it hardens.

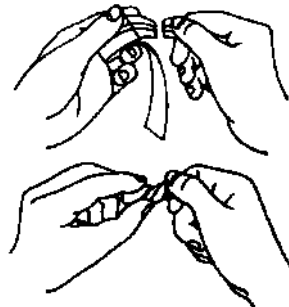

Infinite Uses

U.S.D.A. Authorized



Plumbing Repairs: Sink traps, oil and water tanks, pipe joints, drain leaks, etc.



Electrical: Use in place of tape, ceramic connectors, knobs, etc.



Ceramic Repair: Cracked porcelain wall tile, floor tile, etc.



Auto Repair: Metal Strips, small dent repairing, fuel tank, radiators, etc.



Underwater Repair: Concrete swimming pools, fish tanks, etc.



Custom Formed Gaskets: For permanent sealing and bonding.



Home Repairs: Dethreaded screws in wood or metal, picture hanging, light fixture installation, fixing loose rungs and legs on furniture, air duct leaks, etc.

Safe for lines carrying potable water.

Physical Properties

Density.....	15.8 lb./gal. (1.9gm/cm ³)
Compression Strength	18,000 psi
Tensile Strength	6,000 psi
Modulus of Elasticity	600,000 psi
Shear Strength	700 psi
Izod Impact.....	0.3 ft.-lb/in. of notch
Hardness (Shore D).....	85
Maximum Use Temperature	300°F (149°C)

Electrical Properties

Volume Resistivity	5 x 10 ¹⁵ ohm-cm
Dielectric Strength	400 volts/mil @ 0.125 in.

WARNING: Harmful if swallowed, Eye irritant. Contains epoxy and amine resins. Keep away from children. If swallowed, call physician. For eyes, flush with water and call physician.

Photos not actual size

Weld Pins

Round Head • Copper Plated Steel

By welding these pins to a damaged body panel, a body shop technician can use a gripping tool to pull the dent out of the panel.



Pin Diameter: 2mm (.080")
Length: 2"
Head Diameter: .145"

19095: UNIT PACKAGE: 100
19096: UNIT PACKAGE: 250
19097: UNIT PACKAGE: 500

Pin Diameter: 2.5mm (.098")
Length: 2"
Head Diameter: .175"

19098: UNIT PACKAGE: 100
19099: UNIT PACKAGE: 250
19100: UNIT PACKAGE: 500

Weather-Seal Wrap



Clear, plastic film that has an adhesive on one side that is strong enough to hold the wrap in place on almost any surface and seal out contaminants. Can be easily removed without pulling off paint, leaving adhesive residue or damaging the surface.

It can seal out rain, snow, wind and dirt when windshields or door glass has been broken.

Weather-Seal Wrap can be used to protect vehicle carpet and upholstery from soiling and spills. Apply it to paint booth walls and prevent over spray from discoloring white walls. Wrap has 3 mils of plastic protection to preserve finishes, it can also be used as a temporary, protective coating against light abrasions.

21077

24" wide x 200 ft. long

UNIT PACKAGE: 1 Roll

21078

36" wide x 200 ft. long

UNIT PACKAGE: 1 Roll

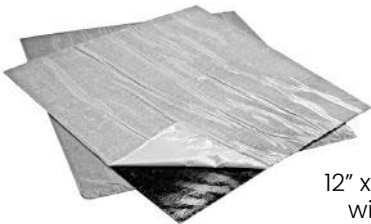

16506
Trunk Vibration/
Sound
Dampening Pads

12" x 12" x .060" thick pads with adhesive backs.

Can be cut to shape and painted for easy installation. The clear vinyl sheet on the black side must be removed before painting.

Meets GM specification #2747M.

UNIT PACKAGE: 6

Moulding Tape

For mounting exterior trim, side mouldings, emblems & nameplates



- Acrylic foam tape with an aggressive, high performance adhesive on both sides.
- Works on all types of plastic mouldings & emblems
- Will not crack or dry out
- Will not absorb water
- Will not migrate in hot weather

21074

.045" thick x 3/16" wide x 54 ft.

UNIT PACKAGE: 1 Roll

21075

.045" thick x 1/2" wide x 54 ft.

UNIT PACKAGE: 1 Roll

21076

.045" thick x 7/8" wide x 54 ft.

UNIT PACKAGE: 1 Roll

21077

24" wide x 200 ft. long

UNIT PACKAGE: 1 Roll

MISCELLANEOUS ITEMS

Photos not actual size

Acid Brushes

Tin Handle Horse Hair Bristles



Auveco Part No.	Width	Trim	Length	Unit Pkg.
15793	1/4"	3/4"	6"	1 Gross
15794	3/8"	3/4"	6"	1 Gross
15795	1/2"	13/16"	6"	1 Gross
15796	9/16"	7/8"	6"	1 Gross
15798	3/4"	1"	6-3/8"	1 Gross

Chip Brushes



Auveco Part No.	Width	Trim	Unit Pkg.
15800	1-1/2"	1-5/8" x 5/16"	5
15801	2"	1-1/2" x 5/16"	4

Chip & Dope Brush

Wood Handle Horse Hair Bristles



Auveco Part No.	Width	Trim	Length	Unit Pkg.
15799	11/16"	1-1/8"	7"	25

Steel Wire Scratch Brushes

Wood Handle



15803
 Size of Block: 14" x 1"
 Rows: 3 x 19
 Trim: 1-3/16"
 Wire Gauge: 33 Gauge Steel

UNIT PACKAGE: 1



15805
 Size of Block: 10" x 1-1/8"
 Rows: 4 x 16
 Trim: 1-3/16"
 Wire Gauge: 33 Gauge Steel

UNIT PACKAGE: 1



Toggle Bolts Spring Wing Type

Auveco Part No.	Head Style	Screw Dia.	Thread Size	Use Drill	Unit Pkg.
10011	Mushroom	1/8"	6-32 x 3"	3/8"	10
10012	Mushroom	1/8"	6-32 x 4"	3/8"	10
10013	Round Slotted	3/16"	10-24 x 3"	9/16"	10
10014	Round Slotted	3/16"	10-24 x 4"	9/16"	10



Plastic Anchors

Auveco Part No.	Screw Size	Drill Size	Unit Pkg.
10005	#4 - #6	3/16"	50
10006	#10 - #12	1/4"	50



Nylon Spacer Bushings Stand-Offs

Tough and resilient white nylon spacer bushings are ideal for use in electrical and electronic applications or anywhere a slip surface is needed. They can be used as bushings, bearings, rollers, glides or separators.

Auveco Part No.	I.D.	O.D.	Length	Unit Pkg.
16198	.257"	1/2"	1/4"	100
16200	.257"	1/2"	3/8"	100
16202	.257"	1/2"	1/2"	100
16204	.257"	1/2"	5/8"	100
16205	.257"	1/2"	3/4"	100
16207	.257"	1/2"	1"	100

Photos not actual size

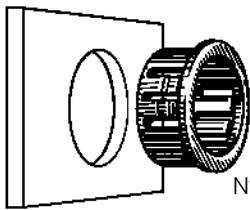

Standard Insulating Bushings

Nylon bushings designed to protect wires, cables, tubing, etc. from sharp, unfinished panel edges. Each size bushing employs multiple lock features to positively snap into panels ranging from 1/32" to 1/8" thickness. Available in both black and white nylon.



Auveco Part No.		Dimensions			Panel Hole Dia.
Black Nylon	White Nylon	Inside Dia.	Head Dia.	Thick-ness	
Unit Package: 50					
16087		1/4"	15/32"	13/32"	3/8"
16088		3/8"	37/64"	13/32"	1/2"
16089		7/16"	21/32"	13/32"	9/16"
16090		1/2"	23/32"	13/32"	5/8"
16092		11/16"	61/64"	29/64"	7/8"
16093		3/4"	1-1/8"	29/64"	1"
16095		15/16"	1-23/64"	29/64"	1-1/4"
Unit Package: 25					
16096		1-5/16"	1-39/64"	29/64"	1-1/2"



ALL-FIT Adjustable Bushings

Black nylon ALL-FIT Adjustable Bushings are designed to protect wire, cable, tubing or irregular shaped items from sharp, unfinished edges.

The specially designed resilient multiple supports absorb shock and vibration, and adjust to accept various diameters and shapes.

The Bushing is equipped with multiple locks to snap in panel thicknesses ranging from 1/32" to 1/8"

Auveco Part No.	Panel Hole Dia.	Bushing Dimensions			Unit Pkg.
		Head Dia.	Thick-ness	Max. I.D.	
16568	1"	1-1/16"	29/64"	3/4"	50



Clear Flexible Vinyl (PVC) Tubing

Our tubing has a broad range of chemical resistance to acids, alkalis and solvents. It's ideal for use in industrial air pressure line applications, in the food industry (FDA approved), for potable water, and for various gases and chemicals.

Auveco Part No.	I.D.	O.D.	Wall Thick-ness	*Max. Suggested Pressure PSI @ 70° F
14801	1/8"	1/4"	1/16"	59
14802	3/16"	5/16"	1/16"	51
14803	1/4"	3/8"	1/16"	51
14804	5/16"	7/16"	1/16"	48
14805	3/8"	1/2"	1/16"	41
14807	1/2"	5/8"	1/16"	28
14808	1/2"	3/4"	1/8"	41

Each 100ft UNIT PACKAGE

**We recommend verification by testing of the size and material to be used.*

Pushnut Fasteners

Axle Caps

- Cover Color - Black
- Cover Material - Plastic
- Caps self-align on shafts
- Low push-on force, high retention
- Fast installation

14178

Shaft Diameter: 3/16"
 Cap O.D., W: .656
 Overall Height, H: .344
 Min. Shaft Extension, A: .150
 Steel Thickness: .012
 Min. Push-on Force: 35
 Min. Holding Strength: 220

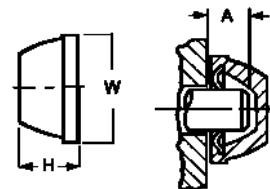

UNIT PACKAGE: 50



Tooth Design

MISCELLANEOUS ITEMS

Photos not actual size



"Nipper" Wire Rope Clip

Galvanized Malleable Iron Base
Zinc Plated Stud U-bolt

Auveco Part No.	Use with Rope Diameter	Diameter	U-Bolt Dimensions Length Overall	Center to Center	Unit Pkg.
12171	1/8"	3/16"	1"	1/2"	6
12172	3/16"	1/4"	1-1/16"	9/16"	6
12173	1/4"	5/16"	1-1/2"	11/16"	6
12177	1/2"	7/16"	2-3/8"	1"	4



Washer Cap Type Pushnut Fasteners

Zinc Finish



Auveco Part No.	Steel Thickness	Height H	Cap Diameter	Washer Diameter D	Stud Diameter	Performance Pounds		Unit Pkg.
						Push-On Force	Min. Holding Strength	
14170	.018	.205	.289	1/2	1/4(.250)	65	280	100
14171	.020	.236	.358	5/8	5/16(.312)	90	460	100
*8719	.020	.234	.419	11/16	3/8(.375)	70	380	100
14172	.025	.270	.431	3/4	3/8(.375)	90	700	100
14173	.030	.328	.504	7/8	7/16(.438)	150	960	100
8665	.030	.328	.567	15/16	1/2(.500)	150	800	100
14174	.031	.413	.693	1-3/16	5/8(.625)	230	1500	50

*Nickel Plated

Push-Pull Controls



14541

5' Long Choke Control
Black Knob
Body Thread: 3/8"-24
Wire Diameter: .047"

UNIT PACKAGE: 1

20243

8' Long Choke Control
Black Knob
Body Thread: 3/8"-24
Wire Diameter: .054"

UNIT PACKAGE: 1



Mechanics Wire

Soft Annealed
Black Steel Wire

Auveco Part No.	Wire Gauge	Wire Length	Unit Pkg.
14205	18	2 LB. (332')	1 Spool
14206	16	2 LB. (192')	1 Spool
14207	18	5 LB. (831')	1 Spool
14208	16	5 LB. (480')	1 Spool



Expansion Plugs

Zinc Plated



Auveco Part No.	Size	Type	Unit Pkg.
3938	5/8"	Concave	100
3939	3/4"	Concave	100
3941	15/16"	Concave	100
3942	1"	Concave	100
3944	1-1/8"	Concave	100
3946	1-1/4"	Concave	100
3949	1-5/8"	Concave	50
3952	7/16" O.S.	Cup	25
3953	1/2"	Cup	25
3956	5/8"	Cup	25
3957	3/4"	Cup	25
3958	7/8"	Cup	25
15212	15/16"	Cup	50
3960	1"	Cup	25
3961	1-1/8"	Cup	25
3963	1-1/4"	Cup	25
3964	1-3/8"	Cup	25
3965	1-1/2"	Cup	25
3966	1-5/8"	Cup	25
3967	1-3/4"	Cup	25
3968	1-7/8"	Cup	25
3969	1-15/16"	Cup	25
3971	2"	Cup	25

See page 149 for Metric Expansion Plugs. For an Assortment of Expansion Plugs see Kit No. 6067

Photos not actual size

Battery Hold Down Bolt with Nut

14461

(Chry: 2534814)
Plain



Battery Hold Down Bolt with Nut
Size: 1/4"-20 x 7"
Thread Length: 2"

UNIT PACKAGE: 10

23298

Chrysler: 2074089



Photo not actual size

Inside Battery Hold Down Bolt with Nut
Size: 1/4"-20 x 9"
Thread Length: 2-1/4"
Chrysler 1962 - On

UNIT PACKAGE 10

8971

(Chry: 2074089)
Plain



Inside Battery Hold Down Bolt with Nut
Size: 1/4"-20 x 9"
Thread Length: 2-1/4"

UNIT PACKAGE: 10

8963

(GM: 3688699)
Plain



Battery Hold Bolt with Nut
Size: 5/16"-18 x 8"
Thread Length: 1"

UNIT PACKAGE: 10

23615

(D0AZ-10756-A)



Photo not actual size

Battery Hold Down Bolt
Size: 5/16"-18 x 8-5/8"
Thread Length: 2-3/8"
Ford 1965 - On

UNIT PACKAGE 10

10643

Zinc



Battery Hold down Bolt with Nut
Size: 5/16"-18 x 12"
Thread Length: 6"

UNIT PACKAGE: 10

10644

Plain



Battery Hold Down Bolt with Nut
Size: 3/8"-16 x 10"
Thread Length: 3"

UNIT PACKAGE: 10



23887

(476737)

Brake Hose Retainer Clip
For mounting front & rear brake hoses
GM Cars & Trucks

UNIT PACKAGE 25

ORDER ONLINE

Auveco's website has been completely renovated. Our new design is user friendly and allows quick and easy ordering.

Product is searchable by car make, OEM number and category, as well as, several attribute drop downs within individual categories. All product also has available inventory listed.

Make sure to head over to

auveco.com

to receive up to date information on all our products.

TOOLS

Photos not actual size

7914

Windshield Reveal Moulding Tool



Used to remove windshield reveal moulding from retaining clips on GM vehicles with rubberless installations

UNIT PACKAGE: 1

13574

Glass Retainer Clip Installer



This tool reduces the risk of chips and scratches to glass windows put in by make shift tools. This tool is specifically designed to fit trim clips over the studs and virtually eliminates glass breakage. It also dispenses with the need to remove rubber-like sealant surrounding the studs.

A practical tool for placing trim retainer clips over headed studs welded around the body window shields and rear window openings.

UNIT PACKAGE: 1

23591

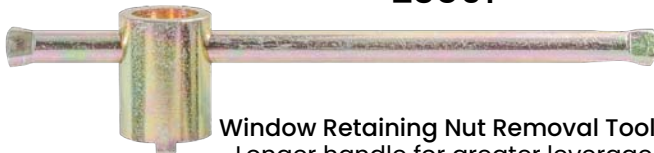

Window Retaining Nut Removal Tool

Longer handle for greater leverage
For cars with bolt-on sash method
Ford, GM & Chrysler Cars

UNIT PACKAGE 6

23810

Plastic



Windshield Setting Tool

Will not scratch or chip glass

UNIT PACKAGE 6

23577



Windshield & Back Glass Tool

Designed to speed closing of self sealing windshield and back glass rubber

UNIT PACKAGE 1

20906

Windshield Locking Strip Tool

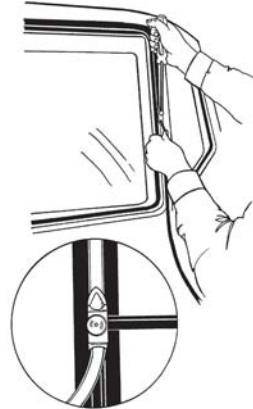

This tool is used when replacing the windshield, rear glass or sliding rear glass on vehicles with locking strips. The unique design allows the tip to swivel 90 degrees in either direction to work where other tools can't. Just select the tip with the opening that most closely fits the locking strip and then feed the locking strip into the eyelet. Overall length: 8-1/4"

UNIT PACKAGE: 1

23567



Windshield Rubber Locking Strip Insertion Tool

Designed for use on larger type locking strip:
Trucks, Buses, off the road equipment, etc.

UNIT PACKAGE 1

23576



Straight Lacing Tool

Locking Strip Insert
For Windshield & Stationary Windows
Dodge Vans 1983 - On

UNIT PACKAGE 1

23578



Windshield and Back Glass Rubber Installation Tool

Right Hand

UNIT PACKAGE 6

TOOLS

Photos not actual size

20907
Windshield Wiper Arm Remover



Makes wiper arm removal and replacement an easy job without damaging the vehicle finish. Simply place the "hook" under the arm base, lift and squeeze the wiper arm and tool handle together.

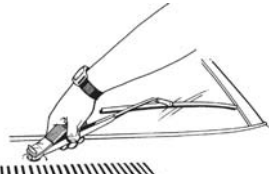

The wiper arm lifts right off.
Reverse the procedure to install a wiper arm.
Overall length: 6-7/8"

UNIT PACKAGE: 1



7778

For removing window crank handle retaining clips. The clip remains in the handle after being "popped off".
Overall Size: 6-1/4"

UNIT PACKAGE: 1



7999

The **Trim Pad Removing Tool** is the first tool designed specifically to pull out the plastic trim pad fasteners used on GM cars. It reaches under the trim panel, supports and grips the plastic fastener, and lifts it without damage to the fastener or to the trim pad backboard. The Trim Pad Removing Tool is made of heat treated, high carbon steel and will work equally well on metal fasteners.

UNIT PACKAGE: 1

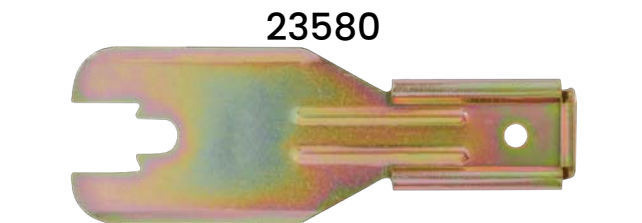

23580

Lock Clip Tool

For blind removal of inside handles. Simple alignment with shaft of handle will locate clip for instant removal:

All GM Cars, Ford 1961 - 1967,
Some Models Rambler 1962 - 1967

UNIT PACKAGE 6

7672

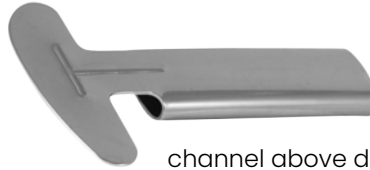

Headliner Tool

stuffs headlining in channel above doors. Stuffs upholstery, trim edges into tedious places.

Blunt edge of blade cannot damage material. Easy to use around curves and near corners.

UNIT PACKAGE: 1

13575



For tucking headlining and upholstery around windows and above doors and other hard to reach places. A sturdy tool with a slightly curved blade that has finished edges and rounded corners. Comfortable wood handle with eyelet hole through one end.

UNIT PACKAGE: 1



17978

Mini Plastic Scraper With Razor Blade

Scraper with razor sharp edge cuts or scrapes paint, stickers, cardboard, string, etc.

Flip a latch and turn the razor blade over to safely store the scraper.

UNIT PACKAGE: 5



13626

A unique retractable scraper that takes

the aggravation out of getting old stickers off car windshields and paint blotches off windows. The scraper is 7-7/8" when fully open and locked in position. The razor blade holder tilts the blade to give a better angle of attack in tight corners. The blade can be folded 180 degrees into the handle and locked when not in use, permitting it to be kept in a tool box safely. The blade can be replaced when worn out and the entire tool is compact and durable as well as economical.

UNIT PACKAGE: 1

TOOLS

Photos not actual size

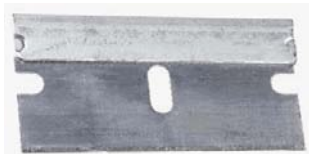

13625

Single Edge Razor Blades
For use with 13626 and
General Purpose

UNIT PACKAGE: 100

Polypropylene Blades

Remove stickers from plastic-coated windshields without risk of scratching or cutting the windshield.

Made of polypropylene, these blades are also ideal for scraping many other surfaces in automotive, industrial and home applications. Use with tool 13626



14543: UNIT PACKAGE: 25

14575: UNIT PACKAGE: 100



20823

Extra Long Sticker Scraper



Specially designed to access steep, sloping windshields and other hard-to-reach places. Excellent for corners and on curved surfaces. Supplied with 5 standard steel razor blades and 1 plastic blade.

Use the plastic blade on laminated windows and plastic bumpers. Extra blades are stored in the handle. Heavy duty construction.
Overall Length: 16"

UNIT PACKAGE: 1

20903

O-Ring and Seal Pick



Quickly removes and installs O-Rings and seals.

Tips are angled for hard-to-reach areas typically found around brakes, air conditioning and transmissions.

The tips are hardened to stay sharp. The handle is knurled for a sure grip.
Overall Length: 8-3/4"



UNIT PACKAGE: 1

17088



All purpose awl with an extra long hook. Use to remove mouldings, body clips, windshield seals, cotter pins and radiator hoses. Made of tough spring steel, heat treated, tempered and plated.
4-7/8" long blade with 2" long hook.
Overall length: 8"

UNIT PACKAGE: 1

18335

Prep Pen (Spot Sanding Pen)
with Glass Fibers

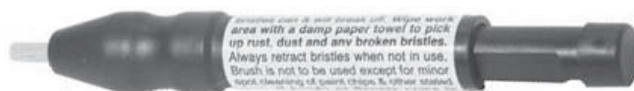

Thoroughly clean rust, dirt or wax from any tight corner, crevice or hard to reach spot with 20,000 glass fibers in a pen point. Fibers finer than human hair and stronger than steel when it comes to cleaning power.

Sand paper can be too rigid to directly contact and clean the contours of inside edges. Thus conventional sanding only cleans the high spots. The Prep Pen's glass fibers can be extended out (by turning) to ensure even the smallest recesses get cleaned.

UNIT PACKAGE: 1

20902

Constant Tension Band
(Flat Band)
Hose Clamp Pliers



Removes and installs hose clamps (Auveco part numbers 18127 - 18132) on heater and radiator hoses. Tips screw in and out to fit all sizes of clamps. Ratcheting lock mechanism holds the clamp in an open position for easy removal and installation. Tips can be switched to accommodate different applications. Offset jaws allow access to hard-to-reach areas.

UNIT PACKAGE: 1

TOOLS

Photos not actual size

7657
Hog Ring Plier



Straight Nose Spring Grip, holds rings in place for fast work.

UNIT PACKAGE: 1

7658
Hog Ring Plier



Offset Angle Nose for close to floor non-removable cushions.

UNIT PACKAGE: 1

Convertible Retaining Ring Pliers

For Internal and External Retaining Rings



7910



Use with
Auveco Retaining Rings:
8679 - 8683 External
8698 - 8699 Internal
8710 - 8712 External
10122 - 10129 External
16743 - 16748 External

UNIT PACKAGE: 1

20905
Hood Prop



Unique 3-Piece telescoping design allows a mechanic to hold open the hood in any desired position from 18-1/2" to 46-3/4". It can be used either in the front of the vehicle or on the side for better access to the engine compartment. Also great for body or repair work on doors, trunk lids and hatchbacks.

Overall length: 18-1/2"

UNIT PACKAGE: 1



Torx® Power Drive Bits
1" Shank

Auveco Part No.	Bit Size	Hex Size	For Screw Size	Unit Pkg.
12472	T-10	1/4"	No. 4	1
11949	T-15	1/4"	No. 6	1
11950	T-20	1/4"	No. 8	1
12103	T-25	1/4"	No. 10	1
14913	T-27	1/4"	No. 12, 1/4"	1
12104	T-30	1/4"	1/4"	1
12105	T-40	1/4"	5/16"	1



Torx® Power Drive Bits
2" Shank

Auveco Part No.	Size	For Screw Diameter	Unit Pkg.
12474	T-15	6	1
12475	T-20	8	1
12477	T-30	1/4"	1

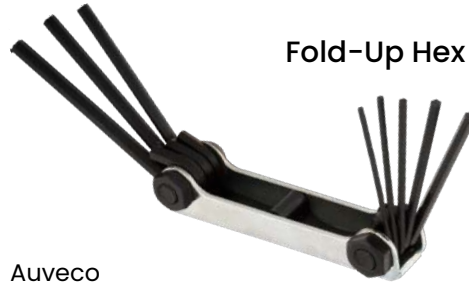

Fold-Up Hex Key Set

Auveco Part No.	Size	Keys	System	Unit Pkg.
7978	Large Extra Long 3/16" thru 3/8"	5	U.S.	1



Hexagon Shank Magnetic Chuck

for Driving Screws into Metal with an Electric Drill.

Auveco Part No.	Hex Head Shank	Screw Size	Unit Pkg.
11761	1/4"	5/16"	1
11762	1/4"	3/8"	1

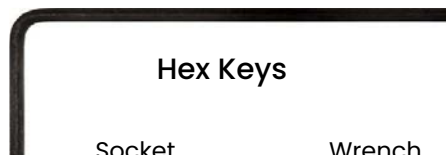

Hex Keys

Auveco Part No.	Socket Screw Size	Wrench Size	Unit Pkg.
5414	No. 6	1/16"	10
5415	No. 8	5/64"	10



Metric Hex Key

Plain Finish
Use with DIN 912 & DIN 7991

Auveco Part No.	Hex Size	For Screw Size	Unit Pkg.
7965	3mm	4mm	10

TOOLS

Photos not actual size



15748
Moulding Cutting Tool

A professional quality tool that cuts with absolute accuracy every time to give a clean, accurate and precise edge. This tool features a replaceable razor-sharp blade, which cuts against a plastic anvil, also replaceable. Excellent for cutting rubber/plastic moulding (up to 3-1/2"), weatherstrip, carpeting and most flexible materials. The tool measures 10" overall and the handles are vinyl coated.

UNIT PACKAGE: 1



20900
Hose Cutter

Razor sharp blade cleanly cuts heater hoses, fuel line hoses and any other type of flexible hose up to 1-1/4" diameter. The stainless steel blade is reversible for double the life. The pliers are made of glass-filled gray nylon for strength. Includes a locking hoop for safe storage.

Overall length: 9-1/2"
UNIT PACKAGE: 1

21511

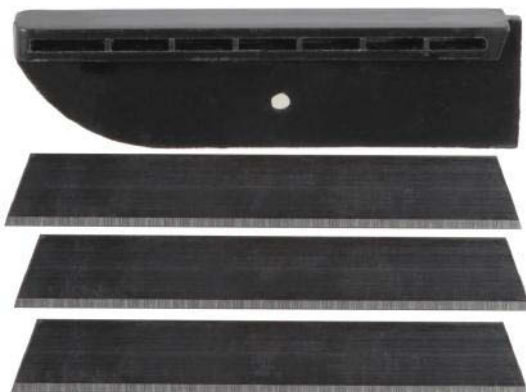

Three replacement cutting blades and one anvil for Moulding Cutting Tool 15748

UNIT PACKAGE: 1 KIT



16894
Wire Bending Tool
For Truck Seat Springs

A tough tool that makes difficult wire repairs easy. You can bend the ends of no sags, edgewise and foam springs right on the spot, making offsets where you need them. Can be readily mounted in a vise for duplicating complex repetitive wire bends. Constructed of heat-hardened steel for long life.

UNIT PACKAGE: 1



16276

Heavy Duty Grease Gun

3-Way Loading
Uses 14.5 oz. Cartridge, 16 oz. Bulk Capacity
10,000 PSI Working Pressure
3 Claw Coupler

UNIT PACKAGE: 1

Grease Gun Hoses

1/8" NPT Male Fittings



Auveco Part No.	Length	PSI	Unit Pkg.
15691	12"	3000 PSI	1
15692	18"	3000 PSI	1

16667



Die Cast Alloy & Steel
Caulking Gun

This professional gun is fabricated from die cast alloy and steel, both riveted and welded for maximum strength. It features a smooth hexagonal drive rod and precision catch plate for effortless action. The handle and trigger are designed for comfortable operation over a long period of use. Corrosion resistant orange epoxy powder coated.

UNIT PACKAGE: 1

13577
Revolving Punch



A fine quality pressed frame revolving punch with drive tubes. All tubes are heat treated to give long wear. Fully nickel plated.

Furnished with tube sizes 0, 1, 2, 3, 5, and 7
(Hole sizes 5/64", 3/32", 7/64", 1/8", 5/32", and 3/16")
Length: 8"

UNIT PACKAGE: 1

Torx® Tool Selection Chart

Auveco Part No.	Size	Pan Head Struck Slot		Head Screw Size							
		Screw Size	Round Washer	Pan	Flat	100 Flat	Hex	Hex Washer	Truss	Fillister	Oval
12472	T-10	4 & 5	4 & 5	4 & 5	5 & 6	6	4 & 5	5	6	4 & 5	5
11949	T-15	6	6	6	8	8	6	6	8	6	6
11950	T-20	8	8	8	10	10	8	8	10	8	8
12103	T-25	10	10	10	12		10	10	12	10	10
14913	T-27	12	12	12	1/4		12	12	1/4	12	12
12104	T-30	1/4	1/4	1/4		1/4	1/4	1/4		1/4	1/4
12105	T-40	5/16		5/16	5/16 & 3/8	5/16	5/16	5/16	5/16	5/16	5/16
	T-45	3/8		3/8		3/8	3/8	3/8	3/8 & 7/16	3/8	3/8
	T-50	7/16		7/16	7/16 & 1/2	7/16			1/2	7/16	7/16 & 1/2
14916	T-55	1/2		1/2	9/16 & 5/8	1/2			9/16 & 5/8	1/2 & 9/16	9/16 & 5/8
	T-60				3/4				3/4	5/8	3/4

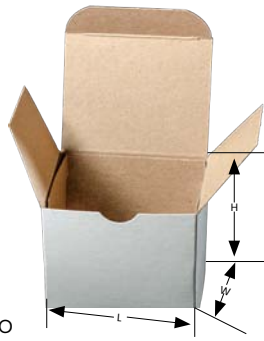

Plain White Boxes

No Imprinting

White-recycled chipboard versions of six popular sizes of Auveco boxes for packaging small parts. Each box is made of .028" thick chipboard. The full-flap, hardware bottom with locking side tabs provides for a full-strength, spill-proof box. Refer to the chart below for the quantity of boxes per unit package carton.

Auveco Part No. (lbs.)	Length (L)	Width (W)	Height	Boxes Per Carton	Weight Per Carton
0-Boxes	2-3/4"	1-1/2"	1-3/4"	1050	30
1-Boxes	2-3/4"	2-1/4"	1-7/8"	800	33
2-Boxes	3-3/8"	2-7/8"	2"	375	23
3-Boxes	3-1/2"	2-7/8"	2-7/8"	250	19
4-Boxes	4-3/4"	2-3/4"	3"	250	21
7-SBoxes	4-1/4"	3"	6-1/2"	425	55

25133

Tire Valve Installation Tool

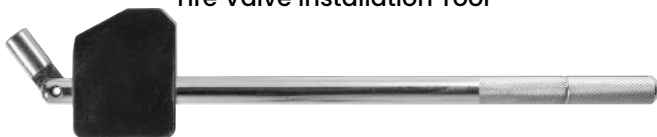

Photo Not Actual Size

- Rubber block protects rims and provides leverage to install/remove snap-in valve stems with ease
- Knurled handle provides a non-slip grip
- Threaded head locks onto the valve for secure installation & removal of the valve – ensures the valve stays securely attached to the tool

UNIT PACKAGE: 1

25134

Valve Core Installation & Removal Tool



Photo Not Actual Size

Screw-driver type plastic handle for superior grip & leverage

UNIT PACKAGE: 1

TOOLS

Photos not actual size

21152
U.S.S., S.A.E. & Metric Bolt and Nut Gauge

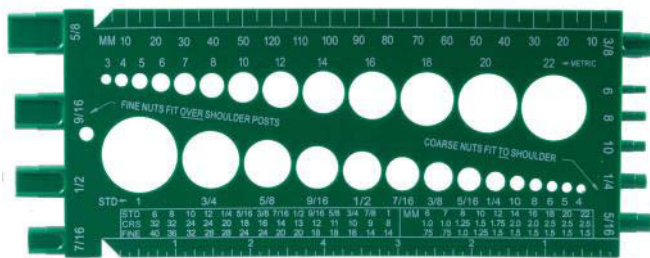

Excellent for sizing bolts, screws, nuts (USS, SAE, and Metric) and twist drills. Determine the bolt diameter by pushing the bolt through the sizing holes, as well as, gauges hex nuts and washers (USS & SAE) size. Metric hex nuts and washers can be measured by holding them under the metric holes.

The back includes a feature for measuring U.S. and Metric thread pitch. Notches on the front allow you to measure flat head metal and wood screws.

Made of sturdy, light weight green plastic that resists water, alcohol, oil and grease.

UNIT PACKAGE: 1

14769
U.S.S. & S.A.E. Plastic Gauge

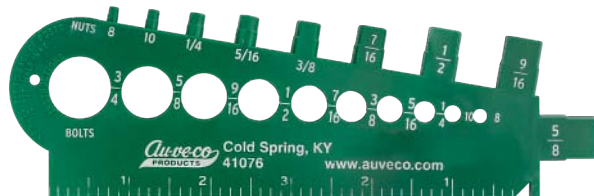

Push bolts through the holes to find the bolt diameter. The length gauge measures "regular" heads from the left end and countersunk heads from the right end notched. Nuts drop on the plugs along the top of the gauge. S.A.E. fine thread nuts fit to the base of the plugs, U.S.S. coarse thread nuts fit half-way.

UNIT PACKAGE: 1

14770
Metric Bolt & Nut Gauge

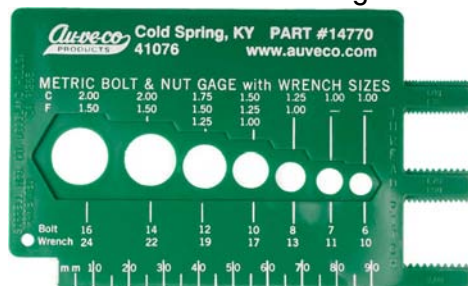

Determine the diameter of the bolts by pushing them through the holes. Measure the hex head of bolts and screws or the "across the flat" dimension of hex nuts in the recesses around the holes (listed as wrench size).

Right-hand side of tool measures thread pitch (1.00, 1.50, 1.75 & 2.00)

UNIT PACKAGE: 1

24097

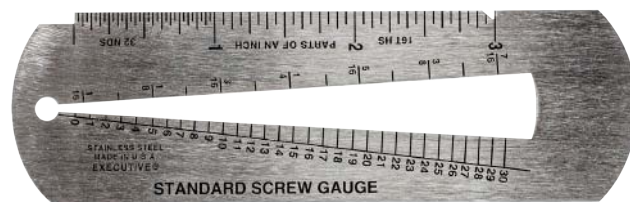

Stainless Steel Gauge

One side for metric and the other side measures fractional inch screw sizes

UNIT PACKAGE: 1



19715
Zinc

Mandrel with 3/8" Shoulder Screw

UNIT PACKAGE: 1



19716
Zinc

Mandrel with 1/4" & 3/8" Shoulder Screws

UNIT PACKAGE: 1

NUMERICAL INDEX

Auveco No.	Page No.	Auveco No.	Page No.	Auveco No.	Page No.	Auveco No.	Page No.	Auveco No.	Page No.	Auveco No.	Page No.	Auveco No.	Page No.
11	435	266	333	418	336	1455	20	2293	146	2633	19	3068	19
30	328	268	333	419	337	1456	20	2303	144	2657	19	3071	21
31	328	287	334	420	337	1457	20	2309	443	2661	19	3072	21
32	328	288	334	421	337	1458	20	2310	443	2666	19	3073	21
33	328	289	334	422	337	1459	20	2330	25	2672	445, 163	3074	21
35	328	291	334	423	337	1479	20	2333	156	2688	27, 38	3076	21
36	328	292	334	424	337	1483	19, 417	2346	143	2698	19, 417	3077	21
37	328	293	334	425	337	1700	156	2354	27	2699	19	3078	21
38	328	294	334	426	337	1712	20	2358	19	2700	19	3079	21
39	328	295	334	427	337	1717	19, 417	2359	19	2702	19	3080	21
45	328	296	334	428	337	1780	24	2360	19	2706	19	3081	21
46	328	297	334	429	337	1781	24	2361	19	2707	19, 417	3082	21
47	328	298	334	430	337	1787	20	2362	19	2709	19	3083	21
49	328	299	334	431	337	1793	19	2364	21	2710	19, 417	3084	21
50	328	300	334	432	337	1794	19, 417	2365	21	2711	19	3085	21
51	328	301	334	433	337	1796	19, 417	2366	21	2712	19	3086	21
52	328	302	334	434	337	1797	19, 417	2367	21	2713	19, 417	3087	21
53	328	303	334	435	337	1798	19	2369	25	2716	19, 417	3088	21
69	328	304	334	437	337	1799	417	2370	25	2717	25	3089	21
70	328	305	334	438	337	1800	19	2385	443	2718	19	3090	21
75	328	306	334	440	337	1801	19	2420	145	2720	19	3091	21
76	328	307	334	455	337	1802	19	2422	145	2722	19	3092	21
77	328	308	334	456	337	1803	19	2426	143	2724	19, 417	3093	21
78	328	309	334	457	337	1804	19	2452	158	2727	19	3099	36
91	328	310	334	464	336	1826	42, 47	2453	158	2728	19	3100	36
101	332	311	334	465	336	1863	27	2472	64, 69	2729	19	3102	36
102	332	313	334	604	154	1877	27	2485	24	2730	19, 417	3135	434
103	332	314	334	612	154	1896	142	2487	24	2731	19	3137	141
105	332	316	334	614	154	1898	142	2515	154, 445	2734	19, 417	3138	143
107	332	317	334	616	154	1899	142	2530	28	2744	864	3144	125
111	332	318	334	618	154, 445	1900	142	2531	28	2751	21, 418	3155	158
112	332	319	334	619	154, 445	1903	142	2532	28	2752	865	3156	158
114	332	320	334	727	124	1905	143	2533	28	2753	27	3165	163
119	333	321	334	728	124	1906	142	2534	28	2769	126	3166	163
120	333	322	334	729	124	1907	146	2535	28	2771	21, 418	3167	163
121	333	325	334	730	124	1912	142	2536	28	2772	21, 418	3168	167
122	333	326	334	731	124	1913	144	2538	28	2773	21	3178	582
123	333	327	334	733	124	1932	19	2539	28	2774	22	3182	63, 68
124	333	328	334	768	156	1933	19	2540	28	2775	22	3183	63, 68
125	333	330	334	807	443	1934	27	2541	28	2789	864	3184	63, 68
126	333	331	334	808	443	1935	21	2542	28	2802	19	3186	205
127	333	332	334	1001	877	1936	21	2543	28	2804	20	3205	19
150	332	333	334	1002	877	1937	21	2544	28	2805	42, 47	3209	582
151	332	334	334	1007	878	1939	21	2545	28	2806	42, 49	3211	21
152	332	335	335	1020	390	1940	21	2546	28	2807	28	3214	24
153	332	336	335	1021	390	1942	21	2548	28	2808	21	3215	24
154	332	337	335	1030	390	1943	21	2550	28	2809	25	3219	24
155	332	339	335	1031	390	1946	20	2554	126	2810	20	3220	24
158	332	341	335	1040	390	2007	156	2555	126	2818	864	3250	125
159	332	342	335	1041	390	2008	156	2556	126	2850	445	3367	25
161	332	343	335	1042	390	2024	19	2557	126	2895	420, 128	3368	25
163	332	344	335	1043	390	2027	19, 417	2558	126	2896	420, 128	3369	25
164	332	347	335	1052	389	2028	43, 54	2560	126	2897	420, 128	3373	25
168	332	348	335	1053	389	2057	145	2561	126	2943	864, 598	3374	23, 25
186	333	349	335	1054	389	2089	142	2562	126	2967	25	3375	25
187	333	350	335	1055	389	2091	142	2571	19	2968	25	3376	23, 25
189	333	351	335	1092	20	2092	142	2572	19	2969	25	3378	25
192	333	352	335	1146	20	2098	142	2575	19	2973	25	3379	25
193	333	353	335	1149	19	2099	143	2578	19	2974	25	3381	25
194	333	355	335	1183	156	2100	142	2579	19	2976	25	3382	25
198	333	356	335	1202	444	2102	143	2580	19	2978	25	3383	25
200	333	359	335	1256	443	2103	143	2581	19	2979	25	3385	25
201	333	360	335	1263	20	2105	143	2582	19	2980	25	3387	25
221	333	370	336	1267	435	2109	24	2583	19	2981	25	3390	25
223	333	371	336	1294	156	2110	24	2585	19	2988	25	3392	25
230	333	372	336	1313	63, 68	2178	43, 54	2595	141	2989	25	3393	25
231	333	374	336	1340	296	2209	38	2597	154, 445	2991	25	3394	25
232	333	385	336	1341	296	2227	156	2598	167, 435	2994	25	3400	128
233	333	401	336	1344	20	2262	132	2604	25	2996	25	3401	128
245	333	405	336	1376	156	2266	24	2605	25	2999	158	3403	128
246	333	406	336	1382	20	2267	24	2611	141	3000	158	3404	128
247	333	413	336	1413	27	2268	24	2619	865	3022	20	3405	128
263	333	415	336	1421	19	2269	24	2625	71	3028	20	3414	36
264	333	416	336	1423	19, 417	2272	443, 665	2628	437	3062	19	3415	36
265	333	417	336	1424	19	2288	435	2632	19	3063	19	3432	36

NUMERICAL INDEX

Auveco No.	Page No.	Auveco No.	Page No.	Auveco No.	Page No.	Auveco No.	Page No.	Auveco No.	Page No.	Auveco No.	Page No.	Auveco No.	Page No.
3433	36	3755	169	4236	430	4447	429	5028	178	5331	24	5453	31
3434	36	3756	169	4237	429	4448	433	5029	178	5332	24	5454	31
3435	36	3758	296	4240	430	4449	433	5030	178	5347	873	5455	31
3438	36	3770	145	4242	429	4450	433	5031	178	5348	873	5456	31
3465	21	3776	141	4243	429	4451	433	5032	178	5349	873	5457	31
3466	21, 418	3777	141	4244	430	4454	176	5034	178	5350	873	5459	31
3467	21	3793	142	4246	429	4456	176	5035	178	5351	873	5462	31
3468	21	3796	143	4248	429	4457	176	5036	178	5352	873	5463	31
3469	154, 445	3797	144	4249	430	4460	176	5037	179	5354	872	5464	31
3470	154, 445	3798	125	4250	430	4462	176	5038	178	5357	872	5465	31
3471	154, 445	3824	163	4258	429	4463	176	5040	178	5358	872	5466	31
3472	154, 445	3868	124	4264	429	4464	176	5041	179	5365	29	5467	31
3484	19	3877	170	4265	429	4466	176	5044	185	5366	29	5468	31
3492	125	3878	170	4273	430	4468	176	5045	185	5367	29	5469	31
3493	125	3879	170	4280	429	4474	431	5046	185	5368	29	5470	31
3494	125	3880	170	4281	430	4511	432	5047	178	5369	29	5471	31
3495	125	3881	170	4305	421	4512	432	5048	178	5370	29	5472	31
3496	125	3882	170	4306	421	4531	432	5049	179	5371	29	5473	31
3497	125	3883	170	4307	421	4588	432	5056	179	5372	29	5474	31
3498	125	3884	170	4308	421	4654	428	5062	181	5373	29	5475	31
3499	125	3885	170	4309	421	4655	428	5063	181	5375	29	5476	31
3500	125	3886	170	4310	421	4656	428	5066	185	5376	29	5477	31
3511	167	3887	170	4311	421	4675	427	5067	180	5377	29	5478	31
3512	167	3888	170	4312	421	4703	427	5068	180	5378	29	5479	31
3513	167	3889	170	4313	421	4707	427	5072	178	5379	29	5480	31
3515	167	3890	170	4314	421	4731	427	5075	158	5380	29	5481	31
3520	167	3891	170	4315	421	4736	428	5076	158	5381	29	5482	31
3521	167	3892	170	4316	421	4737	428	5077	158	5382	29	5483	31
3522	167	3894	170	4317	421	4738	428	5096	158	5383	29	5484	31
3524	167	3895	170	4318	421	4740	428	5097	158	5385	29	5485	31
3538	21	3896	170	4319	421	4742	427	5167	126	5386	29	5486	31
3539	21	3929	154	4320	421	4743	427	5170	146	5387	29	5487	31
3541	125	3930	154	4321	421	4744	427	5195	141	5388	29	5488	31
3542	125	3931	154	4322	421	4745	427	5196	141	5389	29	5489	31
3543	125	3932	154	4323	421	4747	427	5197	145	5390	29	5490	31
3544	125	3933	154	4324	421	4800	426	5219	280	5391	29	5491	31
3545	125	3935	154	4347	421	4801	426	5220	214	5392	29	5492	31
3546	125	3938	882	4348	421	4802	426	5221	280	5393	29	5493	31
3547	125	3939	882	4349	421	4803	426	5225	214	5394	29	5494	31
3548	125	3941	882	4350	421	4804	426	5226	214	5395	29	5495	31
3549	125	3942	882	4351	421	4805	426	5228	71	5396	29	5497	31
3550	125	3944	882	4352	421	4806	426	5238	36	5398	29	5499	31
3553	156	3946	882	4353	421	4807	426	5243	36	5399	29	5500	31
3554	156	3949	882	4354	421	4808	426	5249	156	5400	29	5501	31
3556	156	3952	882	4355	421	4809	426	5250	156	5401	29	5505	31
3609	165	3953	882	4356	421	4811	426	5251	156	5402	29	5510	31
3610	165	3956	882	4369	430	4812	426	5252	156	5403	29	5512	31
3611	165	3957	882	4408	424	4813	426	5253	156	5404	29	5514	31
3612	165	3958	882	4410	424	4850	426	5254	156	5406	29	5516	31
3613	165	3960	882	4411	424	4851	426	5255	156	5408	29	5524	31
3614	165	3961	882	4413	424	4852	426	5256	156	5409	29	5526	31
3615	27, 38	3963	882	4414	424	4853	426	5257	156	5410	29	5527	31
3616	146	3964	882	4415	424	4854	426	5258	156	5411	29	5528	31
3617	447	3965	882	4417	424	4855	426	5259	156	5412	29	5530	31
3620	473, 509	3966	882	4418	424	4856	426	5260	156	5413	29	5537	31
3628	163	3967	882	4419	424	4857	426	5261	156	5414	29, 887	5538	31
3639	473, 509	3968	882	4420	424	4859	426	5262	156	5415	29, 887	5539	31
3682	71	3969	882	4421	424	4860	426	5263	156	5434	31	5542	31
3690	298	3971	882	4422	424	4861	426	5264	156	5435	31	5547	31
3711	27	3975	127	4423	424	5000	185	5265	156	5436	31	5550	31
3712	27	3984	154	4425	424	5002	185	5266	156	5438	31	5551	31
3713	27	3985	154	4426	424	5003	185	5267	156	5439	31	5553	31
3715	27	3986	154	4428	424	5005	185	5268	156	5440	31	5563	142
3717	27	3987	154	4429	424	5006	185	5270	156	5441	31	5571	143
3718	27	3988	154	4430	424	5007	185	5271	156	5442	31	5576	145
3720	27	3989	154	4431	424	5008	185	5272	156	5443	31	5586	146
3722	27	3990	154	4432	424	5009	185	5274	156	5444	31	5589	146
3724	27	3991	154	4433	424	5010	185	5278	64, 65	5445	31	5592	474, 509
3741	126	3992	154	4434	424	5014	185	5290	22	5446	31	5596	126
3743	126	3993	154	4435	424	5015	185	5291	22	5447	31	5600	163
3750	169	4155	430	4436	424	5021	178	5292	22	5448	31	5601	163
3751	169	4188	429	4439	171, 433	5023	178	5301	22	5449	31	5602	163
3752	169	4204	430	4440	171, 433	5024	178	5307	22	5450	31	5603	163
3753	169	4233	429	4441	429	5026	178	5329	24	5451	31	5621	21
3754	169	4235	429	4446	429	5027	178	5330	24	5452	31	5625	21

NUMERICAL INDEX

Auveco No.	Page No.	Auveco No.	Page No.	Auveco No.	Page No.	Auveco No.	Page No.	Auveco No.	Page No.	Auveco No.	Page No.	Auveco No.	Page No.
5626	21	6502	396	6870	407, 415	7978	29, 887	8450	31	8695	161	8881	338
5629	21	6505	396, 399	6871	407, 415	7981	340, 348	8453	31	8696	161	8882	338
5630	21	6506	396, 397	6882	407	7983	340	8454	31	8697	161	8883	338
5632	21	6507	396	6883	407	7984	340	8455	31	8698	161	8884	338
5633	21	6508	396, 397	6901	401, 403	7985	340	8456	31	8699	161	8886	338
5634	21	6511	396, 399	6902	401, 404	7999	885	8477	167	8701	161	8887	338
5646	20	6519	396, 400	6903	401, 404	8003	205	8478	167	8702	161	8888	338
5647	20	6520	396, 400	6904	401, 403	8009	181	8479	167	8703	161	8889	338
5648	20	6522	396, 400	6905	401, 404	8029	28	8480	167	8704	161	8892	338
5649	20	6523	396, 398	6906	401, 404	8033	28	8481	167	8705	161	8893	338
5651	20	6536	396	6907	401, 404	8035	28	8482	167	8706	161	8894	338
5653	20	6539	396	6908	401, 404	8050	19	8483	167	8707	161	8895	338
5654	20	6540	396, 397	6910	401, 405	8056	19	8484	167	8708	161	8896	338
5655	20	6542	396, 400	6912	401, 405	8068	19	8485	167	8709	161	8897	338
5660	20	6543	396, 398	6913	401, 405	8083	19	8486	167	8710	161	8898	338
5661	20	6544	396, 398	6914	401, 404	8096	31	8487	167	8711	161	8899	338
5672	20	6548	396, 400	6915	401, 405	8097	31	8488	167	8712	161	8900	338
5700	28	6549	396, 400	6916	401, 405	8104	31	8489	167	8715	161	8901	338
5702	28	6551	396, 400	6917	401, 404,	8105	31	8490	167	8719	445, 882	8902	338
5704	28	6552	396, 400		405, 406	8107	31	8491	167	8742	129	8903	338
5711	27, 38	6553	396, 399	6919	401, 404	8206	443	8492	167	8744	129	8905	339
5713	27, 38	6554	396, 397	6920	401, 402	8249	64, 65	8493	167	8746	129	8906	339
5714	36	6557	396, 399	6921	401, 402	8250	64, 68	8494	167	8750	214	8911	339
5717	155	6559	396, 398	6923	401, 402	8272	298	8495	167	8754	214	8912	339
5718	155	6560	396, 398	6924	401, 402	8273	298	8496	167	8755	214, 280	8913	339
5719	155	6801	407, 414	6930	401, 403	8277	308	8497	167	8756	214, 280	8914	339
5721	155	6802	407, 414	6931	401, 403	8278	308	8499	167	8759	214	8915	339
5722	155	6803	407, 414	6933	401, 403	8279	308	8500	167	8761	214, 241	8917	339
5723	155	6804	407, 415	6934	401, 404	8281	308	8501	167	8763	241	8918	339
5724	155	6805	407, 415	6938	401, 405	8285	323	8502	167	8764	214	8919	339
5748	338	6806	407, 413	6940	405	8286	323	8506	167	8768	283	8920	339
5749	338	6807	407, 415	6942	401, 404	8288	323	8507	167	8769	283	8922	339
5750	338	6808	407, 409	6946	401	8289	323	8545	141	8772	203	8923	339
5751	338	6810	407, 409	6947	401	8290	338	8546	141	8773	203	8924	339
5752	338	6812	407, 408	6948	401	8291	338	8550	298	8774	192	8925	339
5753	338	6813	407, 409	6949	401	8292	338	8552	36	8775	190	8926	339
5754	339	6814	407, 409	6955	401	8293	338	8557	36	8776	192	8927	339
5755	339	6815	407, 411	7137	154, 445	8294	339	8562	36	8777	190	8928	339
5764	23	6816	407, 410	7138	154, 445	8295	339	8578	141	8781	180	8929	339
5766	23	6817	407, 410	7143	154, 445	8296	339	8583	436	8788	181	8930	339
5767	23	6818	407, 412	7145	154, 445	8297	339	8588	28	8814	148	8931	339
5768	23	6825	407, 413	7147	154, 445	8298	339	8590	28	8824	163	8932	339
5769	23	6826	407, 412	7148	154, 445	8299	339	8594	28	8825	163	8933	339
5773	23	6827	407, 414	7348	445	8300	339	8605	154	8826	163	8934	339
5774	23	6830	407, 411	7349	445	8302	338	8606	154	8827	163	8935	339
5775	23	6831	407, 412	7409	448	8303	338	8607	154	8828	163	8936	339
5776	23	6834	407, 415	7419	448	8304	338	8608	154	8829	163	8937	339
5778	23	6835	407,	7578	444	8305	338	8609	154	8830	163	8938	339
5781	23		414, 420	7595	444	8306	339	8610	154	8831	163	8939	339
5782	23	6836	407, 412	7613	154, 445	8307	339	8611	154	8832	163	8940	339
5783	23	6838	407, 415	7615	154, 445	8308	339	8612	154	8833	163	8941	438
5784	23	6839	407, 415	7616	154, 445	8309	339	8613	154	8834	163	8944	42, 47
5786	23	6840	407, 413	7618	154, 445	8310	339	8623	37	8835	163	8954	72
5787	23	6841	407, 413	7624	154, 445	8311	339	8624	37	8836	163	8963	883
5788	582	6845	407, 414	7625	445	8312	339	8625	37	8837	163	8971	883
5789	582	6846	407, 414	7644	444	8337	144	8626	36	8843	851	8981	168
5791	177	6847	407, 414	7657	887	8341	145	8627	36	8847	38, 41	8983	168
5792	177	6848	407, 408	7658	887	8359	148	8649	155	8853	469, 509	8985	168
5793	177	6850	407, 408	7672	885	8372	148	8650	155	8855	128, 420	8987	168
5794	204	6851	407, 408	7677	448	8375	148	8659	125	8858	127	8988	168
5796	204	6852	407, 409	7678	448	8386	865	8660	125	8861	127	8989	168
5836	143	6853	410	7679	448	8398	865	8661	125	8862	127	8991	168
5854	141	6854	407, 409	7680	448	8400	865	8663	125	8863	127	8992	168
5885	63, 68	6856	407, 411	7682	448	8418	72	8665	445, 882	8864	127	8993	168
5910	64, 66	6857	407, 411	7688	448	8427	63, 69	8677	161	8865	127	8994	168
6004	393	6858	407, 410	7707	445	8435	71	8678	161	8867	127	8995	168
6043	393	6859	407, 413	7711	198	8437	23	8680	161	8868	127	8996	168
6062	393, 394	6861	407, 412	7717	444	8438	23	8683	161	8869	127	8997	168
6116	393, 394	6862	407, 412	7722	444	8439	23	8688	161	8872	338	8998	168
6123	393	6863	407, 412	7723	444	8441	23	8689	161	8873	338	9000	168
6128	393, 394	6864	407, 415	7778	885	8442	23	8690	161	8874	338	9001	168
6166	393, 394	6865	407, 415	7910	164, 887	8443	23	8691	161	8875	338	9002	168
6173	394	6866	407, 414	7914	884	8444	23	8692	161	8877	338	9004	168
6178	393, 394	6867	407, 413	7915	340	8445	158	8693	161	8879	338	9005	168
6187	393, 394	6868	407, 411	7916	78, 887	8449	31	8694	161	8880	338	9006	168
		6869	407, 411										

NUMERICAL INDEX

Auveco No.	Page No.	Auveco No.	Page No.	Auveco No.	Page No.	Auveco No.	Page No.	Auveco No.	Page No.	Auveco No.	Page No.	Auveco No.	Page No.
9007	168	9140	32	9308	125	9525	31	9668	73	10012	880	10220	587
9008	168	9141	32	9309	125	9526	31	9669	73	10013	880	10221	872
9009	168	9142	32	9310	125	9528	31	9670	73	10014	880	10222	283
9010	168	9143	32	9311	125	9535	124	9673	73	10036	126	10223	283
9011	168	9144	32	9312	125	9536	124	9674	73	10048	148	10231	169
9012	168	9145	32	9324	872	9537	124	9675	73	10050	148	10232	169
9013	168	9146	32	9342	447	9538	124	9676	73	10051	148	10242	436
9015	168	9147	32	9353	438	9539	124	9677	73	10052	148	10243	436
9016	168	9148	32	9354	37	9540	124	9679	73	10053	148	10262	619, 647, 662, 665
9017	168	9149	32	9355	37	9541	124	9680	73	10054	149	10264	135
9018	168	9150	32	9356	37	9542	124	9681	73	10055	149	10265	135
9019	168	9151	32	9357	873	9543	124	9683	73	10057	297	10266	135
9021	168	9152	32	9358	873	9544	124	9684	73	10058	297	10267	135
9022	168	9153	32	9361	443	9545	124	9686	73	10064	146	10268	135
9023	168	9154	32	9367	618	9546	124	9687	73	10065	146	10269	135
9024	168	9155	32	9377	649, 807	9547	124	9688	73	10066	146	10270	135
9025	168	9156	32	9381	876	9548	124	9690	73	10067	147	10271	135
9026	168	9157	32	9382	876	9555	26	9692	73	10073	141	10272	135
9027	168	9158	32	9383	876	9556	26	9695	73	10084	38, 40	10273	135
9028	168	9159	32	9384	876	9564	26	9699	73	10085	126	10274	135
9029	168	9160	32	9385	876	9565	26	9701	73	10086	126	10275	135
9030	168	9161	32	9386	876	9566	26	9702	73	10087	126	10276	135
9031	168	9162	32	9387	876	9568	26	9705	73	10090	583	10277	135
9033	168	9163	32	9388	876	9569	26	9711	73	10101	174	10278	135
9034	168	9164	32	9389	875	9570	26	9712	73	10102	174	10282	135
9035	168	9165	32	9391	875	9571	26	9715	73	10103	174	10283	135
9036	168	9167	32	9399	33	9572	26	9727	73	10104	174	10284	135
9037	168	9169	32	9400	33	9575	26	9728	73	10105	174	10288	135
9038	168	9170	32	9401	33	9576	26	9729	73	10106	174	10289	135
9039	168	9171	32	9402	33	9577	26	9731	73	10108	174	10290	135
9040	168	9177	32	9403	33	9582	26	9739	73	10109	174	10305	584, 627, 649
9042	168	9184	32	9404	33	9584	872	9744	73	10110	174	10318	588
9043	168	9186	32	9405	33	9585	872	9745	73	10117	161	10319	181, 187
9044	168	9188	32	9406	33	9586	872	9749	436	10118	161	10330	583
9045	168	9191	32	9407	33	9587	872	9756	38, 40	10120	161	10332	460, 509
9046	168	9192	32	9408	33	9588	872	9757	38, 39	10121	161	10336	343
9048	168	9193	32	9409	33	9589	872	9794	170	10122	161	10337	343
9049	168	9194	32	9410	33	9590	872	9795	170	10123	161	10345	343
9050	168	9199	32	9411	33	9591	872	9796	170	10124	161	10346	343
9051	168	9201	32	9412	33	9592	872	9800	170	10125	161	10357	343
9052	177	9203	32	9416	444	9593	872	9801	170	10126	161	10358	343
9055	177	9208	32	9417	444	9594	872	9802	170	10127	161	10362	38, 40
9056	177	9210	32	9433	167	9595	872	9814	448	10128	161	10364	45, 62
9057	177	9212	32	9435	167	9596	872	9825	25	10129	161	10365	585
9058	177	9219	32	9438	167	9597	872	9829	583	10130	163	10368	173
9059	177	9224	32	9441	167	9598	872	9846	126	10131	163	10374	127
9060	177	9229	47	9443	167	9599	873	9850	446, 587	10132	163	10375	127
9064	177	9246	874	9444	167	9600	873	9851	582	10133	163	10378	199
9065	178	9247	874	9446	167	9601	873	9853	36	10134	163	10379	199
9069	584	9248	874	9447	167	9603	64, 66	9854	36	10135	163	10380	199
9110	165	9249	874	9480	38, 39	9604	24	9855	36	10162	19	10381	199
9112	165	9251	874	9481	187	9605	24	9862	627	10163	19, 418	10382	199
9114	165	9275	436	9482	29	9606	24	9863	42, 47	10164	19	10384	199
9115	298	9278	328	9483	29	9607	24	9864	296	10165	19, 418	10385	187
9118	32	9279	328	9484	29	9608	24	9869	870	10166	19	10386	187
9119	32	9282	328	9485	29	9609	24	9877	42, 46,	10167	19, 418	10390	165
9120	32	9283	328	9486	29	9610	24	9610	446	10168	19	10392	166
9121	32	9285	328	9487	29	9611	24	9879	146	10169	19, 418	10393	166
9122	32	9288	169	9489	29	9612	24	9880	146	10170	19	10394	166
9124	32	9289	169	9490	29	9613	24	9881	147	10171	19	10395	166
9125	32	9290	169	9491	29	9614	24	9882	438	10172	20	10396	166
9126	32	9291	169	9492	29	9615	24	9883	215,	10173	20	10427	75
9127	32	9292	169	9493	29	9616	24		241, 280	10174	20	10431	75
9128	32	9293	169	9494	29	9617	24	9886	435	10175	20	10437	75
9129	32	9297	126	9498	29	9620	24	9890	167	10176	20	10438	75
9130	32	9298	126	9499	29	9625	143	9900	283	10177	20	10440	75
9131	32	9299	126	9500	29	9630	155	9901	283	10179	20	10441	75
9132	32	9300	125	9501	29	9633	436	9905	214, 215,	10180	21	10459	75
9133	32	9301	125	9502	29	9637	301		267, 280	10181	21	10460	75
9134	32	9302	125	9507	29	9639	436	9916	215	10182	21	10478	75
9135	32	9303	125	9509	29	9643	338	9948	203	10183	21		
9136	32	9304	125	9510	29	9644	338	9965	598, 864	10191	425		
9137	32	9305	125	9520	31	9647	338	10005	880	10192	425		
9138	32	9306	125	9522	31	9648	338	10006	880	10217	301		
9139	32	9307	125	9524	31	9667	73	10011	880	10218	301		

NUMERICAL INDEX

Auveco No.	Page No.	Auveco No.	Page No.	Auveco No.	Page No.	Auveco No.	Page No.	Auveco No.	Page No.	Auveco No.	Page No.	Auveco No.	Page No.
10501	76	10587	118	10831	457, 509	11267	78	11442	223	11699	539, 570,	11872	166
10502	76	10588	118	10832	457, 509	11268	78	11443	223		602, 656	11873	166
10504	76	10589	118	10845	78	11269	78	11444	223, 270	11704	539, 570	11874	166
10505	76	10590	118	10846	78	11270	78	11445	250	11705	533,	11876	121
10506	76	10591	118	10848	78	11271	78	11446	215		570, 639	11877	121
10507	76	10592	118	10851	78	11273	78	11448	22	11706	548, 570	11878	121
10508	76	10593	118	10854	78	11274	78	11449	22	11708	108	11879	121
10509	76	10595	118	10855	78	11275	78	11450	22	11709	108	11881	121
10510	76	10596	118	10858	78	11276	78	11451	22	11717	587	11884	121
10511	76	10598	876	10861	78	11277	108	11453	22	11718	582	11886	121
10512	76	10599	876	10864	78	11278	108	11455	22	11719	71	11888	121
10513	76	10600	876	10865	78	11279	108	11456	22	11721	451, 509	11896	121
10514	76	10601	876	10866	78	11280	108	11457	22	11729	204	11904	24
10515	76	10602	876	10868	78	11288	587	11467	204	11733	167	11905	24
10516	76	10603	876	10870	78	11292	144	11470	581, 665	11736	167	11906	24
10517	76	10604	876	10872	78	11294	23	11475	215	11738	172	11908	24
10519	76	10605	876	10875	78	11295	23	11476	215	11740	124	11909	24
10520	76	10606	876	10960	78	11296	23	11488	119, 159	11741	124	11910	24
10521	76	10607	876	10961	78	11297	23	11491	119, 159	11742	124	11911	24
10522	76	10608	875	10972	78	11298	433	11494	119, 159	11746	169	11912	24
10523	76	10609	875	11024	79	11299	433	11495	119, 159	11747	169	11913	24
10524	76	10610	875	11032	79	11311	133	11500	119, 160	11748	169	11914	24
10525	76	10611	875	11049	108	11312	133	11503	119, 160	11749	169	11915	24
10526	76	10613	875	11051	108	11313	133	11505	119, 160	11761	887	11916	24
10527	76	10614	875	11053	108	11314	133	11506	119, 160	11762	887	11917	21
10528	76	10615	875	11055	108	11315	133	11507	119, 160	11768	144	11918	21
10529	76	10617	587	11057	108	11316	133	11514	119, 160	11770	37	11919	21
10530	76	10621	506, 509	11059	108	11317	133	11515	119, 160	11771	37	11920	21
10532	76	10622	437	11061	38, 41	11318	133	11516	119, 160	11774	506, 509	11921	21
10534	76	10630	436	11067	431	11319	133	11517	119, 160	11775	120, 326	11922	21
10535	76	10631	436	11083	205	11320	38, 40	11518	119, 160	11776	120, 326	11923	21
10536	76	10632	446	11084	19	11321	174	11519	119, 160	11777	120, 326	11924	21
10537	76	10642	42, 46	11086	19	11324	132	11520	119, 160	11778	120, 326	11925	155
10538	76	10643	883	11087	19	11325	132	11521	119, 160	11779	120, 326	11926	155
10539	76	10644	883	11088	19	11326	132	11523	119, 160	11780	120, 326	11927	155
10540	76	10652	22	11089	19	11327	132	11527	119, 160	11782	322	11928	155
10541	77	10653	22	11090	19	11328	132	11602	181	11783	322	11929	155
10542	77	10654	22	11092	19	11331	132	11604	181	11784	21	11931	155
10543	77	10655	37	11097	120	11332	132	11605	180	11785	21	11933	155
10544	77	10656	37	11098	120, 326	11345	437	11606	180	11786	21	11935	81, 87
10545	77	10657	37	11099	120, 326	11347	453, 509	11612	451, 509	11787	21	11948	191
10546	77	10658	348	11100	120, 326	11349	505, 509	11614	36	11788	21	11949	26, 94,
10547	77	10666	143	11101	120, 326	11350	464, 509	11615	36	11789	21		887, 889
10548	77	10697	172	11104	339, 348	11351	461, 509	11618	209	11790	21	11950	26, 94,
10549	77	10701	436	11105	339, 348	11352	613	11620	346	11791	21		887, 889
10550	77	10714	45, 62	11106	339, 348	11354	652	11621	347	11792	21	11953	301
10551	77	10719	181	11109	38, 41	11360	203	11625	116, 149	11796	506, 509	11954	301
10553	121	10720	181	11110	38, 41	11361	203	11626	116, 150	11797	490, 509	11955	301
10556	121	10724	185	11118	448, 597	11362	203	11628	117, 152	11805	136	11956	301
10557	121	10729	132	11120	450, 509	11363	203	11629	117, 152	11806	136	11957	301
10558	121	10730	132	11129	449, 509	11364	203	11630	117, 152	11807	136	11958	301
10559	121	10733	128	11130	465, 509	11365	203	11631	117, 153	11808	136	11961	301
10560	121	10737	168, 870	11136	473, 509	11366	203	11633	81, 87	11809	136	11973	74, 107
10564	121	10738	168, 870	11146	457, 509	11367	203	11638	81, 87	11810	136	11974	74, 107
10566	121	10739	168, 870	11152	436, 437	11368	72	11639	81, 88	11811	136	11980	74, 107
10567	121	10740	168, 870	11154	215	11369	64, 67	11640	81, 88	11812	136	11981	74, 107
10568	121	10741	168, 870	11156	215	11370	64, 69	11641	81, 89	11813	136	11982	74, 107
10569	108	10742	168, 870	11157	215, 267	11404	74, 106	11653	649	11814	136	11983	74, 107
10570	108	10744	468, 509	11166	241, 280	11405	181	11654	649	11815	136	11984	74, 107
10571	108	10759	581	11179	127	11406	443	11655	582	11826	581	11987	74, 107
10572	108	10760	649	11181	127	11419	173	11656	582	11827	180	11989	74, 107
10573	108	10764	126	11182	127	11424	583	11657	581	11828	180	11990	74, 107
10574	108	10773	125	11183	127	11425	587	11660	626	11829	180	11991	74, 107
10575	108	10780	443	11184	127	11429	144	11661	626	11830	180	11995	74, 107
10576	108	10782	283	11228	174	11434	283	11671	488, 509	11831	613	11998	74, 107
10577	117	10783	283	11243	581	11435	284	11672	506, 509	11838	583	12009	38, 41
10578	117	10788	168, 870	11244	581	11436	236	11673	461, 509	11841	629	12021	866
10579	117	10789	168, 870	11245	581	11437	261, 274	11675	453, 509	11842	464, 509	12022	866
10580	117	10790	168, 870	11246	581	11438	237,	11677	506, 509	11852	346	12023	866
10581	117	10791	168, 870	11255	78		270, 274	11678	506, 509	11853	340	12024	866
10582	117	10792	168, 870	11259	78	11439	215,	11679	453, 509	11855	583, 807	12025	866
10583	117	10793	168, 870	11262	78		241, 281	11680	451, 509	11863	443	12026	866
10584	118	10808	203	11263	78	11440	231, 272	11691	583	11864	116, 151	12027	866
10585	118	10823	38, 39	11265	78	11441	215,	11697	665	11865	627	12028	866
10586	118	10830	148	11266	78		241, 281			11871	582	12029	866

NUMERICAL INDEX

Auveco No.	Page No.	Auveco No.	Page No.	Auveco No.	Page No.	Auveco No.	Page No.	Auveco No.	Page No.	Auveco No.	Page No.	Auveco No.	Page No.
12030	867	12150	177	12348	81, 88	12491	867	12693	80, 84	12893	19	13002	140
12031	867	12151	177	12350	45, 62	12517	30	12695	129	12894	19	13003	140
12032	867	12152	177		93, 105	12518	30	12697	124	12896	19	13004	140
12034	867	12153	177	12351	45, 60	12519	30	12698	124	12897	19	13005	140
12035	867	12154	180		93, 104	12520	129, 130	12699	124	12899	20	13006	140
12036	867	12155	180	12354	45, 61	12521	129, 130	12700	124	12900	20	13007	140
12037	867	12156	180		93, 104	12522	129, 130	12701	124	12902	21	13008	140
12038	867	12157	180	12359	209	12523	129, 130	12703	124	12903	21	13009	140
12039	869	12158	181	12361	301	12525	129, 130	12704	124	12904	21	13010	140
12040	869	12159	180	12363	209	12528	338	12707	124	12905	21	13011	140
12041	869	12160	80, 85	12367	23	12529	338	12708	124	12907	171, 433	13012	139
12042	869	12161	180, 187	12368	23	12534	213	12710	124	12908	171, 433	13014	139
12044	869	12162	177	12369	23	12535	213	12711	124	12909	463, 509	13016	139
12045	869	12163	177	12370	23	12536	213	12713	585	12916	172	13017	139
12047	868	12164	177	12374	137	12537	213		650, 807	12917	172	13019	45, 59
12049	868	12165	180	12375	137	12538	213	12715	129	12918	172		92, 103
12057	44, 59, 92, 103	12171	882	12376	137	12539	213	12723	124	12919	172	13021	45, 59
		12172	882	12377	137	12540	213	12729	613	12920	172	13025	42, 48
12059	42, 46, 48, 90, 94	12173	882	12378	137	12541	213	12731	461, 509	12921	172	13026	42
		12177	882	12379	137	12542	213	12735	583	12922	172		43, 50
12060	43, 51, 90, 96	12209	171, 433	12380	137	12543	213		649, 851	12923	171	13027	43, 54
		12210	171, 433	12382	137	12544	213	12737	506, 509	12924	172	13030	648
12061	42, 46, 49, 90, 94, 95	12213	22	12383	137	12545	213	12738	43, 51	12925	172	13039	362
			42, 48	12384	137	12546	213		90, 96	12926	172	13040	362
12062	42, 47, 90, 94	12214	22	12385	137	12547	213	12739	42, 47	12927	172	13041	362
		12215	22	12386	138	12548	213		90, 95	12929	171	13042	362
12064	80, 84	12216	22	12387	138	12549	213	12740	42, 49	12930	171	13043	362
12065	80, 86	12217	22	12389	138	12550	213		90, 95	12931	171	13044	362
12066	80, 86	12218	22	12390	138	12551	213	12741	42, 50	12932	173	13045	362
12067	80, 84	12232	80, 83	12391	138	12552	213		90, 95	12933	173	13046	362
12068	45, 61, 93, 104	12233	296	12392	138	12553	213	12742	43, 51	12934	171	13047	362
		12234	296	12394	136	12554	213		90, 96	12935	171	13048	362
		12235	296	12395	136	12555	213	12756	565	12936	171	13049	362
12069	444	12236	295	12396	136	12556	213		570, 603	12937	171	13050	362
12076	295	12237	215, 241	12397	136	12563	587	12757	565	12938	171	13051	362
12077	294	12253	107	12399	136	12565	487, 509		570, 602	12939	173	13052	362
12078	294	12255	107	12400	136	12566	585, 650	12759	462, 509	12940	173	13053	362
12079	209	12259	110	12404	136	12567	539, 570	12766	461, 509	12943	173	13054	362
12080	345	12260	110	12419	202		602, 657	12771	155	12944	173	13055	362
12081	345	12265	148	12420	202	12569	627, 649	12772	155	12946	171	13056	362
12084	345	12268	866	12421	202	12571	461, 509	12773	155	12947	173	13057	362
12085	345	12269	866	12422	202	12575	117, 152	12774	155	12948	173	13058	362
12086	345	12270	866	12423	202	12592	209	12775	155	12949	173	13059	362
12088	345	12271	866	12424	202	12594	587	12776	155	12950	22	13060	362
12089	345	12272	866	12425	202	12595	109, 862	12777	155	12951	22	13061	362
12092	345	12273	866	12426	202	12596	109	12778	155	12952	22	13062	362
12093	345	12274	866	12427	202	12598	267	12779	155	12953	22	13063	362
12094	345	12276	866	12428	202	12599	267	12781	155	12954	22	13064	362
12095	42, 48	12277	866	12429	202	12600	216, 267	12782	155	12955	22	13065	362
12097	43, 51, 90, 96	12278	866	12430	202	12602	588	12783	155	12956	22	13120	363
		12279	866	12431	202	12605	582	12784	155	12957	22	13121	363
12103	26, 94, 887, 889	12280	866	12432	202	12617	129	12785	155	12958	865	13124	363
		12281	866	12433	202	12627	202	12786	155	12959	864	13128	363
12104	94, 887, 889	12283	867	12434	202	12628	202	12787	155	12960	865	13132	363
		12284	867	12435	202	12630	185	12788	155	12961	864	13133	363
12105	26, 94, 887, 889	12285	867	12436	202	12631	185	12789	155	12966	598, 864	13134	363
		12286	867	12437	202	12637	862	12790	155	12971	598, 864	13136	362
12115	107	12288	867	12439	202	12652	359	12791	180, 187	12977	210	13141	772
12117	107	12290	867	12440	202	12653	347	12792	180, 187	12978	133	13158	678
12118	110	12292	867	12441	202	12654	358	12795	19	12979	133	13162	114, 690
12119	110, 667	12293	867	12442	202	12655	347	12796	19	12980	133	13173	850, 862
12122	110	12295	867	12443	202	12656	349	12797	19	12982	133	13179	505, 509
12123	110	12303	868	12444	202	12657	356	12798	19	12983	133		683, 856
12124	110	12305	868	12445	202	12666	116, 151	12799	21	12984	133	13206	853
12125	110	12314	625	12447	202	12667	117, 152	12800	21	12986	133	13215	112
12126	110	12315	625	12470	648	12669	116, 151	12801	20	12987	133		690, 779
12127	110	12322	80, 84	12472	26, 94	12671	444	12802	20	12988	136	13216	112, 690
12129	73	12323	80, 86		887, 889	12675	129	12803	20	12989	136		779, 805
12134	444	12324	80, 84	12474	887	12676	363	12806	20	12990	136		809, 861
12137	462, 509	12327	81, 89	12475	887	12682	871	12807	20	12991	136	13218	112
12144	178	12335	80, 86	12477	887	12683	871	12809	20	12992	507, 509		690, 779
12146	181	12336	81, 88	12485	866	12684	871	12811	20	12995	139	13220	115, 779
12147	177	12339	45, 60	12486	866	12685	871	12818	22	12996	139		805, 863
12148	177		93, 104	12487	866	12686	871	12820	22	12997	139	13223	111
12149	177	12343	81, 89	12488	866	12689	871	12824	588	12999	139		690, 779

NUMERICAL INDEX

Auveco No.	Page No.	Auveco No.	Page No.	Auveco No.	Page No.	Auveco No.	Page No.	Auveco No.	Page No.	Auveco No.	Page No.	Auveco No.	Page No.
13224	111, 779,	13333	33	13530	296	13685	184	13899	157	14055	209	14273	748, 828
13225	111, 717,	13334	33	13537	241	13686	211	13900	157	14060	164	14274	700, 761,
	804, 849	13335	33	13540	216	13691	157	13902	157	14063	164		789, 824
13230	524, 570,	13336	33	13541	216, 267	13692	157	13903	157	14065	164	14275	783,
	775, 863	13337	33	13542	267	13693	157	13904	157	14068	164		790, 827
13231	38,	13339	33	13543	216	13694	157	13905	157	14070	164	14276	115, 849
	39, 139	13340	33	13544	216	13696	157	13906	157	14072	164	14277	825
13232	38,	13341	33	13545	216	13697	157	13907	157	14089	165	14281	700, 827
	39, 139	13342	33	13546	216	13698	157	13908	157	14094	165	14282	475,
13233	267	13343	33	13547	223	13705	81, 89	13909	157	14095	165		510, 703
13234	35	13344	33	13548	223	13707	42, 47	13910	157	14097	165	14287	700
13235	35	13345	33	13549	216	13708	48	13911	157	14098	165	14288	699
13236	35	13346	34	13552	294	13709	44, 55	13912	157	14100	165	14289	451,
13237	35	13347	34	13554	281	13711	42, 49	13913	157	14101	165		510, 704
13239	35	13348	34	13555	294	13712	42, 49	13914	157	14102	165	14291	474,
13240	35	13349	34	13558	216		90, 95	13916	157	14103	165		510, 703
13241	35	13350	34	13559	216,	13717	154, 446	13918	157	14104	165	14298	299,
13242	35	13352	34		241, 267	13718	154, 446	13919	157	14127	355		716, 769
13243	35	13353	34	13564	438	13719	154, 446	13920	157	14130	241	14299	467,
13244	35	13354	34	13574	884	13720	154, 446	13921	157	14133	241		510, 709
13245	35	13355	34	13575	885	13721	154, 446	13922	63, 69	14135	242	14313	700,
13246	35	13356	34	13577	888	13723	154, 446	13927	652	14144	499,		761, 789
13248	35	13357	34	13580	869	13724	154, 446	13930	761, 789		510, 838	14317	699
13252	35	13361	34	13581	870	13725	154, 446	13932	782, 824	14147	565,	14319	479,
13256	34	13362	34	13582	870	13746	341	13933	583		570, 608		510, 705
13258	34	13364	34	13584	870	13747	341	13934	63, 70	14150	189	14323	478,
13260	35	13365	34	13587	870	13748	341	13939	297	14151	189		510, 705
13261	35	13366	34	13590	869	13749	341	13945	506,	14152	190	14328	510, 709
13262	35	13367	34	13599	869	13750	342		509, 798	14153	190	14334	789
13263	35	13368	34	13600	869	13751	342	13946	507, 509	14154	190	14335	782, 790
13264	35	13370	34	13601	869	13752	342	13960	583	14163	465, 510	14337	802
13265	33	13374	34	13610	869	13753	342	13965	141	14170	882	14345	802
13266	33	13377	34	13613	81, 88	13755	341	13966	141, 807	14171	882	14347	478, 510,
13267	33	13391	34	13614	81, 88	13756	340	13967	429	14172	882		795, 832
13268	33	13392	35	13617	80, 85	13757	467, 509	13993	540, 570,	14173	882	14349	474, 510,
13269	33	13393	35	13618	81, 87	13766	344		604, 640	14174	882		763, 794
13270	33	13394	35	13619	81, 89	13767	344	13994	565, 570,	14178	881	14352	475,
13271	33	13395	35	13620	89	13768	344		608, 642	14196	311		510, 794
13272	33	13396	35	13625	886	13770	344	13996	540,	14200	201	14353	478,
13273	33	13397	35	13626	885	13773	345		570, 604	14201	201		510, 795
13274	33	13398	35	13629	295	13774	345	13999	524,	14202	201	14355	474,
13275	33	13401	35	13630	295	13796	344		570, 603	14204	201		510, 794
13276	33	13402	35	13631	295	13810	205	14001	537,	14205	882	14356	479,
13277	33	13403	35	13632	294	13811	205		570, 598	14206	882		510, 795
13278	33	13404	35	13634	284	13814	205	14002	583	14207	882	14359	768
13279	33	13405	35	13636	284	13816	205	14004	341	14208	882	14363	505,
13280	33	13406	35	13639	284	13831	20, 446	14005	341	14217	612,		510, 765
13281	33	13409	34	13644	237, 261	13833	20, 446	14006	450, 510		643, 665	14365	768
13282	33	13411	34	13656	182	13835	20, 446	14007	539, 570,	14225	129	14366	761, 790
13284	33	13413	34	13657	182	13836	20, 446		602, 657	14227	129	14367	449,
13286	33	13414	34	13658	182	13837	20, 446	14008	569,	14228	129		510, 762
13288	33	13420	34	13659	182	13838	20, 446		570	14231	129	14369	550,
13289	33	13421	34	13660	182	13840	20, 446	14009	585	14235	129		570, 767
13290	33	13422	34	13661	182	13841	20, 446	14010	564, 570,	14237	129	14376	298, 768
13291	33	13445	212	13662	182	13842	20, 446		602, 657	14241	129	14388	296
13293	33	13446	212	13663	182	13851	203	14011	537,	14243	129	14392	75
13294	33	13447	212	13664	182	13860	610		570, 602	14244	129	14393	75
13298	33	13450	583	13665	182	13865	169	14012	341	14253	129	14395	75
13299	33	13453	506, 509	13666	182	13869	169	14016	524, 570,	14255	699,	14396	75
13300	33	13454	453, 509	13669	182	13873	169		603, 657		761, 782	14400	76
13304	33	13457	539,	13670	182	13875	169	14017	452, 510	14256	824	14401	76
13306	33		570, 599	13671	182	13877	169	14018	546,	14258	825	14402	76
13311	33	13461	506, 509	13672	182	13879	169		570, 641	14260	532,	14403	76
13312	33	13466	71, 649	13673	182	13881	169	14019	565, 570,		570, 599,	14404	76
13322	33	13467	466, 509	13674	182	13885	169		642, 660		766, 841	14405	76
13323	33	13470	487, 509	13675	182	13887	169	14020	565,	14263	826	14406	76
13324	33	13475	505, 509,	13676	182	13888	157		570, 608	14265	826	14407	76
13325	33		808, 856	13677	182	13891	157	14021	450, 510	14267	748, 828	14408	76
13326	33	13476	133	13678	182	13892	157	14023	341	14268	700, 826	14409	76
13327	33	13477	133	13679	182	13893	157	14030	584, 851	14269	498,	14410	76
13328	33	13514	295	13680	182	13894	157	14031	583		510, 733,	14411	76
13329	33	13523	295	13681	182	13895	157	14032	456, 510		764, 838	14412	76
13330	33	13524	295	13682	182	13896	157	14035	456, 510	14270	499,	14413	76
13331	33	13528	296	13683	184	13897	157	14036	456, 510		510, 838	14414	76
13332	33	13529	296	13684	184	13898	157	14037	585, 650	14271	824	14415	76

NUMERICAL INDEX

Auveco No.	Page No.	Auveco No.	Page No.	Auveco No.	Page No.	Auveco No.	Page No.	Auveco No.	Page No.	Auveco No.	Page No.	Auveco No.	Page No.
14417	76	14551	648	14750	113,	14877	126	15044	566,	15151	301	15388	28
14418	76	14552	664		114, 147,	14878	126		571, 608	15158	186	15389	28
14419	76	14553	624		769, 848	14880	192	15045	566,	15159	186	15390	28
14420	76	14559	623	14751	823	14881	192		571, 608	15160	186	15391	28
14421	76	14561	664	14753	540,	14883	190	15046	206	15161	186	15392	28
14422	76	14575	886		571, 601,	14884	197	15048	206	15162	186	15393	28
14423	76	14580	232		638, 656	14885	197	15050	453, 510	15163	186	15394	28
14424	76	14581	76	14754	627	14887	195	15056	324	15164	186	15395	28
14425	76	14582	76	14756	627, 649	14888	195	15058	325	15165	186	15396	28
14426	76	14583	76	14757	454, 510	14889	195	15061	325	15166	186	15397	28
14427	76	14584	76	14769	890	14892	196	15062	325	15167	186	15398	28
14428	76	14585	76	14770	121, 890	14897	187	15065	324	15168	186	15399	28
14429	76	14587	76	14774	388	14898	180, 187	15067	120, 326	15170	64, 68	15400	28
14430	76	14588	76	14775	388	14903	167	15068	324	15171	42, 48	15401	28
14431	76	14589	76	14777	77	14905	167	15069	324	15172	42, 48	15402	28
14432	76	14590	77	14778	77	14907	167	15072	324	15180	30	15404	28
14433	76	14591	77	14779	77	14908	167	15074	324	15187	341, 353	15413	63, 70
14434	76	14592	77	14780	77	14911	167	15076	324	15188	301	15414	457, 510
14435	76	14595	77	14781	77	14912	167	15077	324	15189	301	15415	324
14436	76	14604	78	14782	77	14913	26, 94,	15082	325	15192	301	15416	324
14437	77	14605	78	14784	77		887, 889	15085	325	15194	301	15417	324
14438	77	14606	78	14787	77	14916	889	15086	325	15196	301	15418	324
14439	77	14607	78	14788	77	14918	217,	15087	325	15197	301	15420	324
14440	77	14608	78	14789	77		242, 276	15088	325	15198	301	15422	325
14441	77	14610	78	14790	77	14920	187	15089	325	15199	301	15424	325
14442	77	14611	78	14791	77	14921	449, 510	15094	324	15200	301	15426	120, 326
14443	77	14612	78	14792	77	14923	169	15096	325	15202	301	15434	120, 326
14444	77	14613	78	14793	77	14947	80,	15097	325	15203	301	15439	324
14445	77	14617	78	14794	77		86, 139	15098	120, 326	15204	199	15440	324
14446	77	14625	108	14796	108	14953	568, 571,	15100	324	15205	199	15444	325
14447	77	14626	108	14797	108		598, 636	15101	324	15206	199	15446	325
14448	108	14632	117	14799	340	14967	619, 647,	15102	324	15208	199	15450	324
14449	108	14633	117	14801	176, 881		662, 665	15103	324	15209	199	15453	431
14450	108	14634	117	14802	176, 881	14970	21	15104	324	15212	882	15456	465, 510
14451	108	14636	118	14803	176, 881	14972	21	15106	324	15239	202	15457	465, 510
14452	108	14642	588	14804	176, 881	14973	21	15107	324	15240	202	15459	619
14453	108	14677	315	14805	176, 881	14974	205	15108	324	15256	202	15461	506, 510
14454	108	14687	715	14807	176, 881	14975	205	15109	324	15257	202	15463	438
14455	108	14688	715	14808	176, 881	14976	38,	15110	324	15258	202	15466	439
14456	108	14690	700, 792	14813	174		39, 139	15111	324	15259	202	15467	439
14457	108	14695	700,	14814	144	14977	38,	15114	325	15260	202	15468	788
14458	108		761, 782,	14820	617, 644		40, 139	15115	325	15325	109	15478	462, 510
14459	108		790, 826	14822	144	14980	110	15116	325	15326	109	15479	463, 510
14461	883	14696	531,	14824	73	14985	467,	15117	325	15327	109	15480	460, 510
14462	189		570, 713,	14827	73		510, 661	15119	325	15328	109	15481	460, 510
14473	63, 66		733, 798	14830	448	14987	526, 571,	15120	325	15329	109	15490	342
14474	181, 212	14697	529,	14833	448		599, 655	15121	325	15330	109	15491	342
14486	347		570, 599,	14834	448	14988	526,	15122	120, 326	15331	109	15497	191
14487	30		713, 765	14836	301		571, 637	15123	120, 326	15332	109	15498	191
14489	30	14698	542,	14837	301	14990	526,	15124	120, 326	15333	109	15499	191
14490	30		570, 714	14838	301		571, 599	15125	120, 326	15334	109	15504	196
14491	30	14703	698	14839	301	14991	539, 571,	15126	120, 326	15335	109	15505	213
14494	30	14705	698	14840	301		600, 638	15127	120, 326	15337	109	15506	213
14495	30	14709	453,	14847	155	14992	534, 571,	15128	120, 326	15345	127	15507	213
14497	30		510, 763	14848	155		637, 655	15129	120, 326	15347	127	15508	213
14499	30	14720	479,	14850	155	14993	540, 571,	15130	120, 326	15350	127	15509	213
14500	30		510, 783	14851	155		601, 776	15131	120, 326	15351	127	15512	76
14501	30	14723	478,	14855	110	14994	565,	15132	120, 326	15355	23	15514	76
14521	108		510, 795	14856	110		571, 601	15133	120, 326	15358	23	15516	77
14526	147	14724	790	14857	452, 510	14995	528,	15134	120, 326	15367	453, 510	15517	77
14527	147	14726	538,	14858	661		571, 600,	15135	120, 326	15373	43, 51,	15518	620
14529	297		571, 799	14859	22		637, 655	15136	120, 326		91, 97	15522	536,
14530	297	14727	569, 571,	14860	22	14997	534,	15137	120, 326	15374	28		571, 639
14531	297		733, 801	14861	22		571, 600	15138	120, 326	15375	28	15523	460, 510
14532	297	14728	497,	14862	22	14998	560,	15139	120, 326	15376	28	15525	874
14533	297		510, 837	14866	118		571, 601	15140	120, 326	15377	28	15526	874
14541	882	14732	846	14867	118	15010	130	15141	120, 326	15378	28	15527	313
14543	886	14736	475,	14868	118	15011	130	15142	120, 326	15379	28	15528	318
14544	298, 611		510, 831	14869	118	15015	130	15143	120, 326	15380	28	15529	319
14545	298	14737	475, 510,	14870	118	15018	131	15144	301	15381	28	15530	319
14546	298, 611		795, 831	14871	118	15035	197	15145	301	15382	28	15531	388
14547	298, 612	14738	477,	14873	126	15037	42, 47	15146	301	15383	28	15532	388
14548	624		510, 833	14874	126	15040	455, 510	15147	301	15385	28	15533	388
14549	624	14739	733, 825	14875	126	15042	571	15148	301	15386	28	15539	175
14550	624, 647	14746	823	14876	126	15043	571, 607	15150	301	15387	28	15540	176

NUMERICAL INDEX

Auveco No.	Page No.	Auveco No.	Page No.	Auveco No.	Page No.	Auveco No.	Page No.	Auveco No.	Page No.	Auveco No.	Page No.	Auveco No.	Page No.
15541	176	15766	422	15922	190	16071	175	16341	136	16609	77	16744	161
15542	176	15767	422	15924	190	16072	175	16342	195	16610	77	16745	161
15543	458, 510	15768	422	15926	211	16087	881	16344	195	16611	77	16746	161
15544	136	15769	422	15927	211	16088	881	16348	195	16612	77	16748	161
15545	36	15770	422	15928	211	16089	881	16349	195	16613	77	16764	117
15586	125	15771	422	15929	211	16090	881	16351	213	16614	77	16766	874
15587	125	15772	422	15930	211	16092	881	16352	213	16617	108	16767	874
15588	125	15773	422	15931	211	16093	881	16353	213	16622	546,	16769	110
15589	125	15774	42, 48	15932	211	16095	881	16354	213		571, 605	16770	127
15590	125	15775	43, 52	15933	211	16096	881	16355	213	16624	538,	16774	109
15591	125		91, 97	15935	191	16132	458,	16356	213		571, 604	16775	458, 511,
15592	125	15776	44, 59,	15937	189		511, 863	16357	213	16625	557,		704, 796
15603	204		92, 103	15938	194	16142	111	16358	213		571, 606	16776	454, 511,
15605	204	15778	80, 85	15939	194	16149	25	16359	213	16629	422		704, 796
15606	204	15779	80, 86	15940	627	16152	25	16360	213	16631	422	16778	505, 511,
15607	204	15780	81, 88	15941	42, 46,	16159	138	16362	27	16632	422		765, 835
15608	204	15783	38, 40		90, 94	16161	138	16363	27	16636	422	16779	479, 511,
15609	204	15788	80, 86	15944	194	16163	136	16365	27	16638	422		705, 832
15618	204	15790	81, 88	15945	194	16164	136	16368	27	16639	422	16780	802, 846
15619	204	15791	80, 84	15946	192	16174	217, 242,	16369	27	16642	422	16782	555, 572,
15620	204	15792	38, 40	15947	193		267, 276	16370	27	16643	422		713, 799
15621	204	15793	880	15948	189	16175	217, 242,	16371	27	16644	422	16783	527,
15622	204	15794	880	15949	188		268, 276	16372	27	16645	422		572, 798
15628	204	15795	880	15950	188	16177	134	16375	27	16646	422	16784	542, 572,
15640	125	15796	880	15952	188	16179	134	16376	27	16648	422		799, 842
15641	125	15798	880	15953	188	16180	134	16380	27	16649	422	16785	133
15642	125	15799	880	15954	188	16182	134	16381	27	16650	422	16788	134
15643	125	15800	880	15955	190	16183	134	16382	27	16665	207, 211	16789	134
15644	125	15801	880	15957	192	16184	134	16383	27	16666	207, 211	16791	340
15645	125	15803	880	15960	191	16187	134	16384	27	16667	888	16792	340
15646	125	15805	880	15966	626	16188	134	16385	27	16671	847	16800	71, 823
15649	125	15807	79, 80	15970	507, 511	16189	134	16386	27	16673	156	16801	195
15650	125	15813	436	15973	340	16190	134	16387	27	16676	156	16804	195
15651	125	15818	81, 87	15997	692	16192	134	16389	27	16680	308	16806	191
15652	125	15827	43, 54	15998	464,	16193	134	16390	427	16681	308	16816	529, 572,
15653	125	15851	297		511, 704	16194	134	16391	427	16682	304		603, 656
15654	125	15858	203	16000	550,	16195	134	16392	427	16683	308	16818	455, 511
15664	457, 510	15860	874		571, 714,	16198	880	16395	427	16684	308	16821	823
15668	465, 511	15861	874		767, 800	16200	880	16399	626	16685	308	16826	63, 67,
15669	506, 511	15862	874	16001	301	16202	880	16407	28	16686	350		80, 84
15670	507, 511	15863	124	16004	198	16204	880	16411	28	16687	351	16828	45, 60,
15672	538,	15864	124	16009	154, 445	16205	880	16412	28	16693	232, 256		93, 104
	571, 656	15865	124	16011	154, 445	16207	880	16416	28	16694	217,	16829	107
15673	620, 662	15867	75	16012	154, 445	16213	447	16418	448		242, 276	16830	110
15674	620, 662	15868	75	16013	154, 445	16236	140	16419	448	16695	491, 511	16832	431
15675	647	15869	75	16015	154, 445	16237	140	16420	200	16697	76	16834	350
15676	583	15870	75	16016	154, 445	16240	140	16421	64, 65	16698	76	16835	560, 572,
15677	148	15871	75	16018	156	16242	140	16422	64, 66	16699	76		601, 656
15684	347	15872	75	16019	156	16244	140	16454	424	16700	76	16842	116, 151,
15687	448	15873	75	16020	156	16248	140	16455	424	16701	76	16843	569, 572,
15688	327	15874	75	16021	156	16251	140	16456	424	16702	76		768, 801
15689	327	15875	75	16022	156	16252	140	16457	424	16703	76	16846	116, 150,
15691	327, 888	15876	75	16023	156	16253	140	16458	424	16705	76	16849	431
15692	327, 888	15877	75	16026	302	16255	140	16470	110, 716	16706	76	16850	431
15694	327	15878	75	16031	339	16259	457, 511	16478	42, 48	16707	76	16851	126
15695	818	15879	75	16032	339	16260	506, 511	16484	178	16708	76	16852	126
15701	564,	15880	75	16033	24	16261	506, 511	16485	178	16709	76	16858	557, 572,
	571, 642	15881	75	16034	24	16262	461, 511	16486	179	16710	76		639, 739,
15702	565,	15888	75	16035	24	16263	462, 511	16487	177	16711	76		767, 800
	571, 608	15890	75	16036	24	16265	565,	16488	177	16712	76	16859	530, 572,
15705	199	15893	75	16037	24		571, 602	16489	177	16713	76		600, 798
15706	199	15895	75	16038	24	16267	146	16506	879	16714	77	16860	786
15707	499,	15896	75	16039	24	16276	327, 888	16514	224	16715	77	16863	465, 511
	511, 839	15903	29	16040	24	16306	847	16525	428	16716	77	16864	353
15709	498,	15910	29	16041	24	16308	316	16527	206	16717	77	16865	448, 597
	511, 838	15911	155	16042	24	16322	117, 152	16534	43	16718	77	16868	873, 874
15711	107	15912	155	16043	24	16323	64, 66	16568	881	16720	42, 50,	16869	873, 874
15748	888	15913	155	16044	24	16325	423	16578	206		90, 95	16870	873, 874
15752	147	15914	155	16045	175	16326	423	16585	217	16721	154	16871	873, 874
15753	301	15915	155	16046	175	16327	423	16586	217	16725	568,	16872	873, 874
15754	301	15916	155	16049	175	16330	423	16589	44, 56,		572, 801	16873	873, 874
15758	64, 65	15917	155	16051	175	16332	423		92, 100	16726	544,	16874	873, 874
15759	620	15918	155, 307	16066	175	16334	423	16593	445		572, 641	16875	873, 874
15764	422	15919	155, 307	16067	175	16335	423	16596	46, 94	16727	166	16876	873, 874
15765	422	15921	190	16070	175	16340	436, 803	16604	872	16736	19	16877	873, 874

NUMERICAL INDEX

Auveco No.	Page No.	Auveco No.	Page No.	Auveco No.	Page No.	Auveco No.	Page No.	Auveco No.	Page No.	Auveco No.	Page No.	Auveco No.	Page No.
16878	873, 874	17003	645, 769	17152	63, 66	17349	788	17468	342, 352	17621	254	18032	526,
16879	874	17004	466, 511	17162	532, 572,	17350	556, 572,	17469	348	17622	255		572, 655
16883	109	17006	352		601, 841		714, 801	17470	349	17623	253	18033	472, 511
16889	21	17010	110	17164	643	17351	538,	17472	557, 572,	17624	261	18102	644
16893	80, 86	17018	157	17167	664		572, 785		785, 801	17625	213	18103	209
16894	447, 888	17019	157	17169	70	17353	129	17478	530, 572,	17626	213	18108	341
16896	288	17020	157	17171	69	17355	437, 733		640, 765	17627	213	18109	327
16897	288	17021	157	17172	217	17360	187	17481	819	17629	172	18110	327
16898	288	17022	157	17173	217	17361	875	17490	185	17631	846	18111	327
16899	286	17023	157	17174	217	17362	875	17491	185	17632	542,	18113	439
16901	286	17028	32	17175	217	17363	875	17492	185		572, 638,	18114	477, 511,
16902	286	17034	38, 39	17176	439	17364	875	17493	181		726, 766		672, 705
16904	286	17035	38, 41	17188	79	17365	875	17494	181	17634	450,	18115	702
16905	286	17036	187	17189	79	17366	875	17496	341		511, 794	18119	559,
16906	286	17037	179	17190	79	17367	875	17499	32	17636	71		573, 715
16907	286	17038	179	17191	79	17368	875	17509	428	17639	359	18121	323
16908	286	17039	179	17192	543,	17378	561,	17510	428	17641	355	18122	323
16909	286	17040	178		572, 711		572, 801	17513	428	17642	644	18127	872
16910	286	17041	177	17193	114, 804	17379	551,	17515	137	17643	643	18128	872
16911	286	17042	179	17194	817		572, 714	17516	137	17649	507, 511	18129	872
16912	286	17043	179	17195	630,	17381	464, 511	17517	137	17650	43, 51	18132	872
16913	286	17044	179		651, 692,	17383	526,	17518	137	17654	343	18134	423
16914	286	17045	179		733, 782		572, 601,	17519	137	17655	343	18135	423
16915	286	17046	179	17196	792		816, 840	17522	137	17659	250	18136	423
16916	286	17047	179	17199	228	17385	114, 804	17523	137	17661	253	18137	423
16917	286	17048	179	17205	478,	17387	79	17524	137	17664	457, 511	18138	423
16918	286	17049	179		511, 705	17388	79	17525	137	17669	501, 511	18139	423
16919	286	17052	179	17206	532,	17389	79	17526	137	17683	256	18140	423
16920	286	17057	546,		572, 841	17390	79	17528	137	17684	261	18141	423
16921	286		572, 714	17207	169	17392	108	17529	137	17685	504, 511	18142	423
16922	286	17058	699	17208	169	17393	117	17530	137	17686	181, 212	18143	423
16923	286	17060	637, 768	17214	526,	17395	117	17531	137	17690	237	18144	423
16924	286	17073	440		572, 599	17396	118	17532	137	17975	466, 511	18145	188
16926	286	17075	490, 511	17215	465, 511	17397	118	17533	138	17977	356	18146	188
16927	286	17076	459,	17216	557,	17398	118	17537	138	17978	885	18147	188
16930	21		511, 733		572, 606,	17399	76	17538	138	17980	64, 66	18148	188
16931	81, 89	17080	657		641, 659	17400	76	17540	138	17988	548, 572	18149	188
16934	166	17081	542,	17218	488, 511	17401	76	17542	138	17992	552, 572	18150	188
16936	624		572, 714	17219	588	17403	77	17554	631	17993	113	18151	188
16937	625	17084	126	17220	341	17404	77	17555	120, 326	17994	286	18152	189
16938	490, 511	17085	176	17222	534, 572,	17408	346, 348	17559	74, 106	17995	286	18153	616
16940	356	17086	872		603, 640	17410	346, 354	17560	74, 106	17996	286	18156	64, 65
16942	823	17087	876	17226	535,	17411	346	17561	30	17997	286	18157	475,
16949	715	17088	886		572, 604	17415	346	17562	30	17998	286		511, 703
16951	817	17091	70	17227	524,	17416	346	17563	30	17999	286	18165	538,
16954	644	17092	507, 511		572, 601	17419	346	17564	30	18000	286		573, 711
16955	306	17094	156	17228	69	17420	346	17565	30	18001	286	18166	473,
16956	306	17095	156	17230	584	17421	346,	17566	30	18003	286		511, 798
16959	440	17096	697	17237	466,		359, 667	17569	30	18004	286	18167	347
16960	64, 67	17098	64, 65		511, 796	17422	346	17570	30	18005	286	18168	356
16962	221	17101	342	17238	138	17423	346	17573	30	18006	286	18169	353
16964	232	17102	488, 511	17239	138	17425	346	17574	30	18007	286	18170	359
16966	281	17103	534,	17241	138	17427	346	17575	30	18008	286	18174	455, 511
16967	220,		572,	17242	138	17433	343	17577	30	18010	286	18175	488, 511
	227, 284		603, 640	17243	138	17437	624	17578	30	18011	286	18177	79
16968	221, 248,	17107	232	17244	138	17438	817	17579	30	18012	286	18180	81
	269, 277	17109	223	17248	138	17439	535,	17580	30	18013	286	18194	201
16969	202	17110	232,	17249	138		572, 754	17582	30	18014	286	18202	171, 433
16970	202		254, 256	17261	309	17442	696	17584	30	18015	286	18203	171, 433
16971	202	17111	227	17262	309	17443	693	17586	140	18016	286	18204	171, 433
16972	202	17112	226, 253	17263	309	17452	475,	17588	876	18017	286	18205	171, 433
16973	202	17113	224	17264	309		511, 795	17589	876	18019	304	18206	542, 573,
16974	202	17114	221	17265	309	17453	452,	17596	74, 106	18020	304		641, 766
16975	202	17121	354	17267	556,		511, 763	17597	286	18021	307	18208	144
16976	202	17122	647		572, 676	17459	43, 55,	17598	251	18022	312	18215	256
16977	202	17124	487, 511	17287	528,		91, 99	17599	508, 511	18023	314	18216	256
16978	134	17143	560,		572, 713	17460	43, 50	17604	423	18024	315	18217	253, 261
16980	110		572, 715	17315	63,	17461	44, 58,	17605	423	18025	316	18218	250
16981	125	17144	559,		65, 79		92, 102	17606	423	18026	318	18238	70
16983	125		572, 714	17316	63, 66, 79	17462	180	17607	423	18027	320	18239	63, 70
16986	37, 106	17145	321	17339	472, 511	17463	221	17612	458, 511	18028	341	18240	70
16989	343	17146	321	17341	439	17464	202	17615	349	18030	539,	18241	63, 70
16996	308	17147	321	17342	789	17465	202	17616	567,		572, 658	18242	341
16997	42, 46	17148	321	17347	552,	17466	356		572, 609	18031	341	18244	354
17002	192	17151	437, 652		572, 801	17467	349	17620	251			18248	473, 511

NUMERICAL INDEX

Auveco No.	Page No.	Auveco No.	Page No.	Auveco No.	Page No.	Auveco No.	Page No.	Auveco No.	Page No.	Auveco No.	Page No.	Auveco No.	Page No.
18249	661	18438	871	18673	261	18842	477,	18935	356	19107	207	19219	535, 573,
18261	42,	18439	871	18674	232		512, 833	18936	507, 512	19108	499,		755, 845
	50, 90,	18440	871	18679	462, 512	18844	497,	18938	357		512, 839	19220	618
	95, 96	18441	871	18680	462, 512		512, 837	18939	546,	19109	494,	19228	760
18262	616	18442	871	18682	452, 512	18848	488, 512		573, 754		512, 836	19231	544,
18265	537,	18443	871	18683	449, 512	18849	310	18948	451,	19111	356		573, 675
	573, 799	18444	871	18684	449, 512	18855	196		512, 795	19112	477,	19232	538,
18268	566,	18445	871	18688	462, 512	18856	196	18950	497,		512, 833		573, 674
	573, 609	18446	871	18690	192	18857	196		512, 837	19113	476, 512,	19233	554, 573,
18269	562,	18447	871	18692	471, 512,	18858	196	18951	559,		751, 833		675, 711
	573, 660	18448	871		763, 834	18861	481,		573, 786	19114	477, 512,	19235	423
18270	538,	18449	116, 151	18693	207		512, 835	18952	186		672, 705	19237	44,
	573, 755	18457	692	18694	207	18862	502, 512	18979	434	19115	699		56, 631
18271	475,	18458	478,	18695	207	18866	697	18980	79	19116	472,	19238	630
	512, 763		512, 763	18696	207	18867	226, 253	18981	213		513, 710	19239	552, 580,
18277	463, 512	18460	43,	18697	207, 208	18868	233	18982	213	19117	700		606, 675, 711,
18294	502,		54, 22	18698	207, 208	18870	233,	18983	213	19118	551,		756, 785, 844
	512, 708	18461	351	18699	207, 208		253, 256	18986	213		573, 711	19240	44, 56
18296	43,	18463	261	18700	207, 208	18871	231	18987	213	19121	458,	19244	564,
	52, 53	18465	286	18701	207, 208	18873	547,	18988	213		513, 831		573, 642
18297	474, 512,	18466	286	18702	207, 208		573, 843	18989	213	19123	476,	19245	549,
	750, 831	18468	286	18703	207	18874	500,	18990	213		513, 833		573, 659
18298	450, 512	18469	286	18705	207		512, 839	19000	171, 433	19124	478,	19246	544,
18299	302	18470	286	18706	207	18875	484,	19001	171, 433		513, 832		573, 799
18301	455, 512	18473	287	18707	207		512, 836	19002	171, 433	19125	242	19248	536,
18302	450, 512,	18474	287	18708	207	18876	498,	19003	171, 433	19126	242		573, 863
	672, 703	18475	287	18726	304		512, 837	19004	256	19127	459, 513	19250	457, 513
18303	348	18477	287	18727	339	18877	472, 512,	19006	43, 53,	19128	550,	19251	92, 100
18304	350	18478	287	18728	339		672, 710		91, 97		573, 844	19252	873
18308	549,	18479	287	18729	339	18878	477,	19007	309	19129	502,	19253	873
	573, 606	18482	873	18730	339		512, 833	19013	531,		513, 839	19254	873
18310	565, 573	18483	872	18731	339	18882	636, 760		573, 841	19130	311	19257	499, 513,
18320	221	18484	64, 69	18732	339	18885	420	19016	500,	19132	340		754, 838
18324	189	18485	69	18733	207, 211	18887	208		512, 839	19133	340	19258	182
18325	189	18486	69	18734	207, 211	18888	550,	19017	441	19134	340	19260	182
18326	190	18487	69	18735	207, 211		573, 844	19018	441	19139	309	19261	182
18327	539, 573	18488	69	18736	207	18889	357	19021	441	19140	558, 573,	19262	182
18329	354	18489	339	18737	207	18890	647	19022	441		599, 656,	19263	359
18334	566, 573	18499	348	18738	207	18891	647	19023	441		676, 786, 845	19270	490, 513
18335	886	18500	348	18743	342	18892	647	19025	342	19141	317	19271	176
18336	43, 53,	18501	341	18744	342	18893	539,	19027	342	19142	533,	19272	176
	91, 98	18502	341	18746	466, 512,		573, 637	19028	342		573, 713	19273	176
18337	116, 149	18503	566,		672, 704	18894	539,	19031	342	19145	495, 513,	19274	551,
18338	116, 150		573, 642	18749	355		573, 638	19033	342		673, 706		573, 800
18339	117, 153	18508	473, 512	18750	169	18895	540,	19034	342	19147	804	19275	490, 513
18340	43, 54,	18509	468, 512	18769	63, 67		573, 638	19036	342	19149	451, 513	19277	628
	91, 99	18510	467, 512	18770	512	18896	560,	19037	342	19155	466, 513	19278	43, 52,
18342	69	18515	80, 84	18771	462, 512		573, 607	19045	338	19156	250, 251		91, 97
18343	70	18518	206	18779	63, 65	18897	451, 512	19046	338	19157	256	19279	317, 536,
18346	69	18519	206	18781	42, 95	18900	170	19047	338	19162	147		574, 601
18347	70	18520	206	18798	169	18901	170	19048	338	19170	44, 59,	19282	156
18348	69, 70	18521	206	18799	169	18902	170	19049	339		92, 103	19283	156
18353	530,	18522	206	18800	169	18903	170	19050	339	19171	471,	19284	156
	573, 609	18524	232	18801	169	18904	170	19051	339		513, 710	19285	156
18354	64, 67	18525	218	18802	169	18905	170	19053	339	19176	324	19286	156
18371	456, 512	18527	232, 256	18803	169	18906	170	19055	339	19177	324	19287	156
18373	311	18530	237	18804	169	18907	170	19056	339	19178	324	19288	156
18374	314	18533	424	18806	169	18908	170	19057	339	19186	525, 573,	19289	156
18375	317	18534	424	18807	79	18910	170	19058	339		674, 710	19290	156
18377	632	18537	424	18808	79	18911	587	19060	339	19191	662	19291	156
18379	455, 512	18540	424	18809	79	18913	341	19061	339	19194	584, 827	19293	791
18383	627	18543	424	18810	357	18914	647	19062	344	19195	536,	19294	211
18389	450, 512	18646	423	18815	452, 512	18915	501, 512	19066	340		573, 858	19296	211
18391	489, 512	18647	423	18816	631	18917	233	19076	254, 261	19197	461, 513	19298	180
18392	619	18650	191	18817	42, 49,	18918	221	19095	879	19199	205	19299	180
18393	619	18651	192		90, 95	18921	268	19096	879	19202	349	19306	536,
18394	566,	18653	191	18818	473,	18923	218	19097	879	19203	495,		573, 766
	573, 660	18654	191		512, 709	18924	218	19098	879		513, 837	19310	663
18398	447, 597	18658	192	18819	261	18925	221	19099	879	19204	823	19311	533,
18401	117, 153	18659	192	18824	491,	18926	620	19100	879	19206	287		573, 713
18402	443, 444	18661	288		512, 764	18927	354	19102	207, 211	19207	287	19312	452,
18415	701	18662	288	18827	465, 512	18930	504, 512	19103	207, 211	19210	501,		513, 830
18416	81, 87	18665	303	18829	304	18931	302	19104	207		513, 839	19314	782
18436	871	18668	248	18830	304	18932	302	19105	207	19213	487, 513	19315	551,
18437	871	18671	251	18836	173	18934	45, 60	19106	207	19216	109		573, 767

NUMERICAL INDEX

Auveco No.	Page No.	Auveco No.	Page No.	Auveco No.	Page No.	Auveco No.	Page No.	Auveco No.	Page No.	Auveco No.	Page No.	Auveco No.	Page No.
19317	72, 617	19467	474,	19628	502, 513	19744	454, 514	19889	257	20243	882	20346	648
19318	313		513, 672	19630	303	19746	449	19892	567,	20244	549,	20347	314
19320	481,	19468	464,	19638	568, 573,	19747	541,		573, 602		575, 610	20348	559,
	513, 784		513, 730		640, 661		573, 766	19893	454, 514	20245	627		575, 800
19322	782	19470	454,	19639	538,	19749	471,	19894	653	20246	262	20349	542, 575,
19323	477,		513, 704		573, 604,		514, 834	19898	499,	20247	542, 575,		666, 755,
	513, 783	19472	610, 643		640, 658	19752	631		514, 838		711, 785		799, 842
19325	469,	19480	117, 152	19643	453,	19756	827	19900	744	20248	557,	20350	699
	513, 784	19481	470,		513, 830	19757	591	19904	537,		575, 687	20351	699
19330	782		513, 765	19644	153	19760	460, 514		573, 863	20252	505,	20352	537,
19331	475,	19483	473, 513,	19645	529,	19764	170	19905	550,		514, 856		575, 713
	513, 783		672, 710		573, 599	19765	170		573, 800	20253	506, 514,	20353	594
19334	485,	19485	72,	19646	700	19766	170	19907	549,		684, 775	20355	636
	513, 784		649, 782	19650	701	19767	170		573, 843	20256	452,	20358	635
19337	530,	19486	582	19653	43,	19769	170	19908	549,		514, 796	20359	547,
	573, 642	19490	540,		91, 98	19770	170		573, 843	20259	44, 55,		575, 605
19338	464, 513		573, 842	19655	465, 513	19771	170	19910	499,		92, 99	20360	459, 515
19339	664	19499	204	19657	349	19772	170		514, 837	20261	81, 87	20362	461, 515
19355	529,	19505	827	19658	620	19773	317	19927	416	20262	461, 514	20363	532,
	573, 603	19506	452, 513,	19661	251	19774	455, 514	20164	466, 514	20263	437, 588		575, 643
19356	490, 513		672, 704	19666	424	19775	504, 514	20165	449, 514	20264	630	20364	43, 55
19359	697	19511	534,	19667	454, 513	19777	64, 66	20169	533,	20265	565,	20365	543,
19361	587		573, 643	19669	113,	19778	43, 54		573, 642		575, 601		575, 605
19365	321	19514	353		114, 147	19779	664	20171	630	20266	789	20366	456, 515
19368	470, 513	19515	354	19673	451,	19781	623	20172	255	20270	550,	20367	545,
19373	458, 513	19516	359		513, 709,	19782	623	20173	664		575, 687		575, 638
19376	352	19519	614,		769, 848	19783	631,	20175	864	20271	43, 52,	20373	19
19378	865		663, 666	19678	468, 513		747, 825	20176	84		91, 97	20374	19
19379	594	19522	528,	19682	477,	19786	440	20177	455, 514	20273	575,	20375	42, 48
19386	500, 513		573, 603		513, 705	19787	527,	20179	650		639, 656	20376	43, 53
19393	440	19524	508, 513	19683	472,		573, 600	20180	468, 514	20274	488, 514	20377	592
19394	440	19526	631		514, 710	19788	526,	20181	470, 514	20275	650	20380	300, 678,
19397	438	19527	490, 513	19684	472,		573, 600	20182	467	20276	437		716, 758,
19406	349	19529	846		514, 798	19790	457, 514	20184	453,	20277	262		769, 786,
19407	560,	19533	701	19686	449,	19793	650		514, 830	20279	507, 514		803, 847
	573, 715	19535	748, 828		514, 830	19795	298, 611	20187	525, 573,	20280	588	20381	476,
19408	559,	19538	304	19687	364	19797	819		775, 857	20281	461, 514		515, 703,
	573, 714	19539	304	19688	364	19798	22	20188	505,	20282	287		783, 795
19411	588	19541	513	19689	364	19800	591		514, 773	20283	287	20382	43, 53,
19413	446, 636	19545	309	19690	364	19801	534,	20189	459, 514	20284	287		91, 97
19414	346	19546	538,	19691	364		573, 640	20190	503, 514	20285	287	20383	351
19415	697		573, 713	19692	364	19802	488, 514	20191	637	20286	287	20386	698
19416	544,	19547	538,	19693	364	19804	505, 514	20192	456, 514	20291	287	20387	698
	573, 713,		573, 710	19694	364	19807	865	20196	529,	20292	287	20388	556,
	766, 842	19548	107	19697	364	19810	487, 514		575, 840	20294	287		575, 687
19417	62,	19552	535,	19698	364	19813	262	20203	568,	20295	287	20389	268
	93, 105,		573, 841	19701	364	19816	434		575, 777	20296	287	20390	819
	610, 661	19555	237	19702	364	19817	434	20205	772	20299	287	20391	819
19418	469, 513	19582	251	19705	364	19820	592	20206	210	20301	64, 67	20392	636
19419	350	19587	323	19706	364	19821	596	20207	210	20303	701	20395	618
19421	646	19588	313	19711	364	19822	592	20209	194	20310	535,	20396	618, 646
19422	547,	19589	313	19712	364	19826	144	20210	194		575, 639	20397	298, 611
	573, 658	19590	306	19713	364	19834	459, 514	20212	191	20311	451, 514	20399	453, 515
19424	623	19591	307	19714	364	19836	451, 514	20213	191	20314	528,	20400	631
19425	468, 513	19592	307	19715	364, 890	19837	459, 514	20214	191		575, 775	20401	646
19428	505, 513	19593	307	19716	364, 890	19840	825	20215	191	20316	461, 514	20402	347
19429	585	19597	73	19719	482,	19842	455,	20216	193	20318	589	20407	568,
19436	646	19601	306		514, 835		514, 832	20217	193	20319	459, 514		575, 863
19440	298, 611	19602	598	19721	828	19843	820	20218	193	20320	210	20408	589
19441	635	19603	304	19724	473,	19845	463, 514	20219	194	20322	158	20411	495, 515,
19443	416	19604	307		514, 798	19846	463, 514	20220	193	20326	590		673, 706
19444	416	19605	307	19726	529,	19847	562,	20221	193	20327	546,	20412	828
19445	416	19607	536,		573, 599		573, 602	20222	193		575, 799	20415	618, 646
19449	469, 513		573, 639	19728	472,	19849	545,	20223	193	20328	592	20416	116, 152
19453	574, 666	19613	586		514, 834		573, 639	20224	193	20331	692	20417	592
19455	86	19614	586	19729	476, 514,	19850	469, 514	20225	194	20334	454,	20421	646
19456	347	19615	558,		751, 833	19851	298, 612	20226	193		515, 703	20422	618
19458	347		573, 607	19731	495,	19853	612	20227	193	20335	540,	20423	618
19459	353	19618	323		514, 797	19855	457, 514	20230	194		575, 842	20424	438
19460	356	19619	323	19734	669	19880	257	20231	194	20338	491, 515	20426	316
19461	346	19620	323	19735	113, 804	19881	262	20232	437, 588	20339	116, 149	20427	503, 515
19464	483	19621	306	19739	559, 573,	19882	237,	20233	563,	20341	507,	20428	503, 515
19466	494,	19623	253		704, 845		257, 262		575, 639		515, 856	20429	820
	513, 673	19626	864	19741	700	19885	254	20234	533, 575,	20344	450, 515	20431	825
		19627	864	19742	747, 827	19887	262		685, 775	20345	462, 515	20434	79, 80

NUMERICAL INDEX

Auveco No.	Page No.	Auveco No.	Page No.	Auveco No.	Page No.	Auveco No.	Page No.	Auveco No.	Page No.	Auveco No.	Page No.	Auveco No.	Page No.
20437	496, 515, 837	20527	586	20609	466, 515, 673, 704	20735	505, 515, 773	20838	250	20931	547, 576, 843	21004	183
20440	828	20528	449, 515	20610	499	20736	729, 792	20839	253	21005	184	21006	218
20443	471, 515, 834	20529	586	20611	515, 708	20737	747, 817	20840	248	21007	484, 516, 764	21010	551, 576, 844
20444	503, 515	20530	630	20613	480, 515, 705	20738	561, 575, 657	20841	253	21011	852	21012	534, 576, 841
20446	64, 66	20531	455, 515	20614	545, 575, 799	20739	355	20842	248	21013	593	21014	483, 516, 753, 836
20448	158	20532	758, 846	20616	787	20740	355	20843	251	21015	594	21016	822
20449	158	20533	758, 846	20618	503, 515	20741	355	20844	253	21017	584	21018	112, 732, 804
20452	585	20534	465, 515	20620	190	20742	618	20845	257	21019	530, 576, 600	21020	595
20453	303	20535	575, 604	20621	503, 515	20743	816	20846	242	21021	488, 516	21022	438
20454	307	20536	479, 515, 724, 737	20622	190	20744	816	20847	263	21023	561, 576, 657	21024	541, 576, 641, 766
20455	44, 57, 92, 102	20537	724, 737	20623	287	20745	318	20848	250	21025	561, 576, 657	21026	458, 516
20457	560, 575, 659	20538	544, 575, 638	20624	287	20746	189	20849	251	21027	503, 516	21028	341
20458	557, 575, 659	20539	262	20625	661	20747	189	20850	253	21029	596	21029	595
20462	306	20540	262	20626	455, 515	20748	190	20851	614	21030	596	21031	561, 576, 657
20464	596	20541	262	20627	462, 515	20749	190	20852	632	21032	553, 576, 731, 800	21033	541, 576, 641, 766
20465	540, 575, 766	20542	251	20628	355	20750	198	20853	561, 576, 607	21034	576, 600	21035	595
20466	585, 629	20543	263	20629	349	20751	198	20854	561, 576, 607	21036	576, 600	21037	525, 576, 775
20468	650	20544	211	20630	349	20752	198	20855	592	21038	761	21039	718
20469	757, 846	20545	211	20631	455, 515	20753	562, 576, 801	20856	508, 516	21040	495, 516, 674, 707	21041	320, 535, 576, 776
20470	758, 846	20546	211	20632	489, 515	20754	341	20857	463, 516, 540, 576, 604, 750	21042	761	21043	354
20471	298, 611	20547	211	20633	559, 575, 607	20755	549, 576, 767	20858	540, 576, 604, 750	21044	761	21045	79
20472	110, 671, 702	20548	45, 60, 93, 103	20634	497, 515, 666, 838	20756	593	20859	755, 842	21046	761	21047	314
20473	484, 515, 753, 836	20549	45, 60, 93, 104	20635	489, 515	20757	749, 829	20860	653	21048	495, 516, 674, 707	21049	79
20474	339	20550	492, 515, 753, 836	20636	586	20758	749, 829	20861	745	21050	674, 707	21051	79
20475	194	20551	493, 515, 753, 836	20637	527, 575, 776	20759	323	20862	476, 703	21052	562	21053	79
20476	43, 52, 97	20552	493, 515, 753, 836	20638	551, 575, 776	20760	469, 515	20863	516, 774	21054	634	21055	79
20478	202	20553	211	20639	555, 575, 686, 777	20761	456, 515	20864	545, 576, 605	21056	45, 62, 93, 106, 494, 516, 610, 643, 661, 764	21057	64, 722, 736
20479	362	20554	211	20640	527, 575, 775	20762	653	20865	482, 516	21058	591	21059	501, 516, 674, 708
20480	362	20555	504, 515	20641	527, 575, 775	20763	729, 789	20866	476, 516, 703	21060	567, 576, 660	21061	718
20481	594	20556	557, 575, 675, 712	20642	481, 515, 773	20764	502	20867	615	21062	651	21063	722, 736
20482	643	20557	557, 575, 675, 712	20643	481, 515, 773	20765	515, 666	20868	596	21064	651	21065	727
20483	643	20558	718, 736	20644	481, 515, 773	20766	556, 576, 659	20869	596	21066	635	21067	721
20485	621	20559	719	20645	778	20767	547, 576, 658	20870	476, 516, 703	21068	545, 576, 658	21069	64, 722, 736
20486	201	20560	110, 93, 104	20646	772	20768	547, 576, 658	20871	615	21070	545, 576, 658	21071	821
20487	201	20561	481, 515, 784	20647	772	20769	576, 658	20872	596	21072	634	21073	821
20488	201	20562	481, 515, 784	20648	111, 779	20770	477, 515	20873	596	21074	634	21075	879
20489	201	20563	496, 515, 753, 837	20649	299, 778	20771	655	20874	596	21076	634	21077	879
20490	201	20564	496, 515, 753, 837	20650	299, 779	20772	655	20875	596	21078	634	21079	879
20491	201	20565	770	20651	299, 779	20773	655	20876	596	21080	634	21081	127
20492	201	20566	770	20652	299, 779	20774	655	20877	596	21082	634	21083	64, 67
20493	201	20567	770	20653	299, 779	20775	655	20878	596	21084	634	21085	350
20494	201	20568	770	20654	299, 779	20776	655	20879	596	21086	634	21086	748
20495	201	20569	770	20655	299, 779	20777	655	20880	596	21087	634	21087	786
20496	201	20570	110, 717, 781	20656	299, 779	20778	655	20881	596	21088	634	21088	551, 576, 659, 776
20498	201	20571	481, 515, 784	20657	299, 779	20779	655	20882	596	21089	634	21089	499, 516, 707
20499	201	20572	481, 515, 784	20658	299, 779	20780	655	20883	596	21090	634	21090	483, 516
20500	201	20573	481, 515, 784	20659	299, 779	20781	655	20884	596	21091	634	21091	545, 576, 638
20501	201	20574	481, 515, 784	20660	299, 779	20782	655	20885	596	21092	634	21092	460, 516
20502	875	20575	496, 515, 753, 837	20661	299, 779	20783	655	20886	596	21093	634	21093	488, 516
20503	875	20576	481, 515, 835	20662	299, 779	20784	655	20887	596	21094	634	21094	698
20504	875	20577	515, 835	20663	299, 779	20785	655	20888	596	21095	634	21095	697
20505	875	20578	549, 575, 599, 755, 843	20664	299, 779	20786	655	20889	596	21096	634	21096	697
20506	875	20579	549, 575, 599, 755, 843	20665	299, 779	20787	655	20890	596				
20507	875	20580	515, 835	20666	299, 779	20788	655	20891	596				
20508	875	20581	549, 575, 599, 755, 843	20667	299, 779	20789	655	20892	596				
20509	875	20582	549, 575, 599, 755, 843	20668	299, 779	20790	655	20893	596				
20510	875	20583	549, 575, 599, 755, 843	20669	299, 779	20791	655	20894	596				
20511	875	20584	549, 575, 599, 755, 843	20670	299, 779	20792	655	20895	596				
20512	875	20585	549, 575, 599, 755, 843	20671	299, 779	20793	655	20896	596				
20514	612	20586	549, 575, 599, 755, 843	20672	299, 779	20794	655	20897	596				
20515	500, 515	20587	549, 575, 599, 755, 843	20673	299, 779	20795	655	20898	596				
20516	554, 575, 640	20588	549, 575, 599, 755, 843	20674	299, 779	20796	655	20899	596				
20521	594	20589	549, 575, 599, 755, 843	20675	299, 779	20797	655	20900	596				
20523	653	20590	549, 575, 599, 755, 843	20676	299, 779	20798	655	20901	596				
20525	651	20591	549, 575, 599, 755, 843	20677	299, 779	20799	655	20902	596				
		20592	549, 575, 599, 755, 843	20678	299, 779	20800	655	20903	596				
		20593	549, 575, 599, 755, 843	20679	299, 779	20801	655	20904	596				
		20594	549, 575, 599, 755, 843	20680	299, 779	20802	655	20905	596				
		20595	549, 575, 599, 755, 843	20681	299, 779	20803	655	20906	596				
		20596	549, 575, 599, 755, 843	20682	299, 779	20804	655	20907	596				
		20597	549, 575, 599, 755, 843	20683	299, 779	20805	655	20908	596				
		20598	549, 575, 599, 755, 843	20684	299, 779	20806	655	20909	596				
		20599	549, 575, 599, 755, 843	20685	299, 779	20807	655	20910	596				
		20600	549, 575, 599, 755, 843	20686	299, 779	20808	655	20911	596				
		20601	549, 575, 599, 755, 843	20687	299, 779	20809	655	20912	596				
		20602	549, 575, 599, 755, 843	20688	299, 779	20810	655	20913	596				
		20603	549, 575, 599, 755, 843	20689	299, 779	20811	655	20914	596				
		20604	549, 575, 599, 755, 843	20690	299, 779	20812	655	20915	596				
		20605	549, 575, 599, 755, 843	20691	299, 779	20813	655	20916	596				
		20606	549, 575, 599, 755, 843	20692	299, 779	20814	655						

NUMERICAL INDEX

Auveco No.	Page No.	Auveco No.	Page No.	Auveco No.	Page No.	Auveco No.	Page No.	Auveco No.	Page No.	Auveco No.	Page No.	Auveco No.	Page No.
21097	788	21165	629	21231	650	21297	552,	21367	790	21458	449,	21530	541,
21098	544,	21166	213	21232	723		577, 711	21368	628		517, 708		577, 726,
	576, 638	21169	503, 516,	21233	525,	21300	629	21369	817	21459	115,		739, 814
21099	654		544, 666,		577, 726	21301	460, 517	21370	595		732, 804	21531	811
21102	497, 516,		667, 711	21234	822	21302	611	21371	736	21470	693	21532	488, 517
	753, 838	21170	677, 715	21235	822	21303	452,	21372	740	21472	211	21533	868
21103	525,	21171	760	21236	649		517, 703	21374	593, 654	21473	211	21534	416
	576, 840	21172	529,	21237	828	21304	630	21375	597	21474	211	21535	489, 518
21104	529,		577, 637	21238	566,	21305	779,	21376	563, 577	21475	211	21536	489, 518
	576, 840	21173	556, 577,		577, 602		781, 860	21377	610	21476	211	21537	745
21105	479,		675, 712	21239	628	21306	632	21378	115,	21477	537,	21538	483,
	516, 773	21174	634	21240	493, 516	21307	477,		727, 740		577, 712		518, 835
21106	211	21175	653	21241	463, 516		517, 762	21379	503, 517	21478	850	21540	114,
21107	483, 516,	21176	563, 577	21242	593	21308	668	21380	464, 517	21479	547,		150, 809
	673, 706	21177	596	21244	720	21309	802	21381	468, 517,		577, 859	21541	44, 58,
21109	694	21178	306	21245	359	21310	300, 661		724, 737	21480	851		92, 103
21110	542,	21179	303	21246	527,	21311	542,	21382	468, 517,	21482	563,	21543	669, 697
	576, 766	21180	303		577, 601		577, 799		724, 737		577, 859	21544	747, 825
21111	729, 791	21181	63, 69	21247	500, 516	21312	718	21383	489, 517	21484	735	21545	556, 577,
21112	533,	21182	69	21248	460, 516	21313	464, 517	21384	586	21485	861		732, 800
	576, 600	21183	69	21249	526,	21315	357	21387	613	21487	622	21546	744, 817
21114	349	21184	353		577, 840	21316	590	21388	677, 715	21488	482, 517	21547	542, 577,
21116	309	21186	693	21250	502, 517	21317	182	21391	527,	21489	485, 517		755, 842
21118	498,	21187	613	21251	563,	21319	635		577, 858	21490	218, 237,	21548	449, 518,
	516, 784	21188	492, 516,		577, 859	21321	720	21392	458,		243, 263,		752, 834
21119	557,		726, 738	21253	454,	21322	811		517, 854		268, 274	21549	744, 817
	576, 768	21189	504, 516		517, 830	21324	729, 790	21395	850	21493	849	21550	819
21120	533,	21190	537,	21254	479,	21325	537,	21398	507,	21494	505,	21551	479,
	576, 841		577, 712		517, 832		577, 842		517, 856		517, 856		518, 834
21121	786	21191	826	21255	746	21326	318	21399	852	21495	482, 517,	21552	469,
21122	42, 49,	21192	553,	21256	874	21327	341	21401	196		807, 856		518, 523,
	90, 95		577, 731,	21257	459, 517	21328	531,	21402	338	21496	481, 855		752, 834
21123	545,		767, 800	21258	309		577, 726	21404	621	21497	478,	21553	299, 847
	576, 842	21194	818	21259	300, 803	21329	497, 517	21405	622		517, 854	21554	495,
21124	357	21195	434	21260	183	21331	826	21406	622	21498	851		518, 706
21125	469, 516	21196	620	21261	183	21332	517, 830	21410	491,	21499	682, 772	21555	668, 695
21128	592	21197	620	21262	183	21333	502, 517		517, 836	21500	553,	21557	668, 694
21129	594	21198	633	21263	183	21334	469, 517	21411	828		577, 814	21558	668, 695
21131	503,	21199	453, 516	21264	183	21335	597	21412	486,	21501	563,	21559	668, 694
	516, 674	21200	595	21265	183	21336	758, 846		517, 765		577, 815	21560	454,
21132	822	21201	547,	21266	183	21338	460, 517	21414	496,	21502	498,		518, 763
21134	555,		577, 756	21267	183	21339	202		731, 797		517, 812	21561	760
	576, 800	21202	633	21268	183	21340	202	21415	508,	21503	596	21562	810
21135	317	21203	299, 612	21269	183	21341	202		517, 857	21504	594	21563	556,
21136	720	21204	668	21270	183	21342	202	21417	673, 706	21505	746		577, 815
21137	491,	21205	701	21271	183	21343	202	21418	348	21506	633	21564	809
	516, 781	21206	496,	21272	183	21344	202	21419	695	21507	632	21565	469,
21138	498,		516, 707	21273	183	21345	202	21420	560,	21508	850		518, 813
	516, 781	21207	693	21275	183	21346	488, 517		577, 815	21509	480,	21566	536,
21140	532,	21208	494, 516,	21276	183	21347	584	21421	464,		517, 855		577, 814
	576, 785		674, 707	21277	184	21348	567,		517, 812	21510	851	21567	482,
21141	543,	21210	242, 276	21278	183		577, 660	21422	550,	21511	888		518, 812
	577, 708	21211	466,	21279	183	21349	453,		577, 814	21512	850	21568	549,
21143	469,		516, 833	21280	183		517, 737	21424	197	21513	861		577, 815
	516, 780	21212	228	21281	183	21350	453,	21426	108	21517	45,	21569	810
21144	507,	21213	651	21282	184		517, 737	21427	561,		62, 93,	21570	535,
	516, 856	21214	644	21283	184	21351	619		577, 657		106, 610		577, 813
21145	857	21215	646	21284	613	21352	316	21428	585	21518	586	21571	551,
21146	542,	21216	696	21285	787	21353	315	21429	679	21519	450, 517,		577, 814
	577, 739	21217	822	21286	358	21354	318	21431	688, 778		730, 795	21572	809
21147	728	21218	525,	21287	463, 517	21355	299, 727	21432	679	21520	478,	21573	473,
21148	635		577, 840	21288	464,	21356	722	21436	213		517, 763		518, 811
21149	492,	21219	635		517, 796	21357	749	21437	213	21521	670, 701	21574	494,
	516, 707	21220	218, 276	21289	497,	21358	749	21438	213	21522	634		518, 812
21150	721	21221	822		517, 796	21359	113,	21439	354	21523	634	21575	810
21152	121, 890	21223	654	21290	619		759, 848	21440	359	21524	616	21576	564,
21153	654	21224	629	21291	786	21360	496,	21442	661	21525	547,		577, 815
21154	653	21225	543,	21292	723		517, 725	21443	464, 517		577, 756	21578	562,
21156	594		577, 843	21293	313	21361	564, 577,	21446	341	21526	438		577, 815
21157	597	21226	483,	21294	550,		609, 801	21450	482,	21527	780	21579	810
21158	590		516, 835		577, 844	21363	736		517, 855	21528	654	21580	552,
21159	798	21227	465, 516	21295	473,	21364	485, 517	21453	818	21529	546,		577, 814
21160	728	21229	471, 516,		517, 794	21365	482, 517	21456	862		577, 605	21581	809
21161	596		730, 794	21296	474,	21366	562,	21457	735			21584	491,
21162	823	21230	635		517, 831		577, 845						518, 813

NUMERICAL INDEX

Auveco No.	Page No.	Auveco No.	Page No.	Auveco No.	Page No.	Auveco No.	Page No.	Auveco No.	Page No.	Auveco No.	Page No.	Auveco No.	Page No.
21585	524, 578, 813	21649	306	21717	26	21826	628	21927	809	22036	593	22090	504, 519, 684
21586	822	21650	316	21718	26	21827	596	21930	789	22037	597	22091	508, 519, 682
21587	810	21651	551, 578, 711	21719	26	21828	213	21931	805, 807	22038	633	22092	508, 519, 682
21588	477, 518, 794	21652	466, 518, 704	21726	26	21829	213	21935	527, 578, 809	22039	553, 578, 731, 799	22093	508, 519, 683
21589	452, 518, 811	21653	819	21731	26	21831	213	21936	450, 519, 805	22042	809	22094	520, 742
21590	811	21654	497, 518	21732	26	21832	213	21943	473, 519, 805	22043	811	22095	561, 578, 859
21591	482, 518, 812	21655	340	21733	26	21833	213	21944	496, 519, 806, 808	22044	810	22096	748, 828
21592	552, 578, 814	21657	741	21735	26	21834	213	21949	472, 519, 805	22045	110	22097	758, 847
21593	530, 578, 813	21658	531, 578, 785, 813	21736	26	21835	652	21961	807	22046	478, 519, 811	22098	861
21594	552, 578, 814	21659	780	21737	26	21836	692	21963	805	22047	563, 578, 815	22099	634
21596	556, 578, 757, 845	21661	453, 518, 763	21738	655	21837	45, 62, 93, 105	21966	806	22048	492, 519, 813	22100	553, 578, 606
21597	697	21662	525, 578, 765	21739	597	21840	80, 83	21975	481, 519, 805, 808	22049	546, 578, 767	22101	561, 578, 859
21598	213	21663	524, 578, 765	21742	352	21841	44, 58, 92, 101	21976	384	22050	810	22102	748, 817
21599	213	21664	732, 804	21743	762	21843	853	21978	495, 519, 806	22051	748, 824	22103	466, 520, 752, 832
21600	213	21666	654	21744	44, 58, 92, 103	21844	745, 820	21980	470, 519, 854	22052	557, 578, 687	22104	43, 52, 91, 97
21601	536, 578, 660	21667	595	21745	615, 646, 663, 740, 816	21846	745, 820	21981	467, 519, 853	22053	463, 519	22105	116, 151, 717
21602	213	21668	634	21746	44, 56, 92, 100	21847	745, 820	21982	853	22054	476, 703	22106	45, 59, 92, 103
21603	213	21669	634	21747	44, 56, 92, 100	21849	528, 578, 754, 840	21987	852	22055	787	22107	468, 520, 798
21604	213	21672	545, 578, 605	21748	745, 818	21850	728, 793	21988	852	22056	483, 752, 835	22108	850
21605	747, 827	21673	454, 518	21749	213	21851	485, 519, 742, 855	21990	531, 578, 858	22057	481, 519, 683	22109	689
21606	63, 70	21674	585	21750	213	21854	508, 519, 682	21994	850	22058	529, 578, 637	22110	44, 55, 92, 99
21608	70	21675	494, 518, 707	21751	213	21855	553, 578, 756, 844	21995	856	22059	792	22111	44, 57, 92, 102
21609	33, 64, 66	21676	495, 518, 707	21752	213	21856	746, 822	21997	508, 519, 857	22060	470, 519, 730, 794	22112	554, 578, 675, 712
21610	621	21677	309	21753	616	21857	543, 578, 766	21999	802	22061	728, 787	22113	116, 149, 150, 690, 861
21611	847	21678	484, 518, 764	21754	616	21858	543, 578, 766	22001	475, 519, 831	22062	664	22114	112, 690
21614	114, 848	21679	455, 518	21755	452, 518, 763	21859	863	22003	496, 519, 725, 738	22063	483, 519, 730, 796	22115	779
21615	114, 759, 849	21680	541, 656	21756	457, 518	21860	561, 578, 757, 845	22004	498, 519, 725	22064	762	22116	861
21618	787	21682	748	21757	476, 682	21862	769	22005	495, 519, 726, 739	22065	613	22117	617
21619	786	21683	787	21758	518, 687	21863	718, 734, 782	22006	501, 519, 725	22066	358	22118	213
21620	533, 578, 799	21686	492, 518	21759	525, 578, 685	21864	351	22007	718, 734, 384	22067	357	22119	213
21621	790	21687	759, 848	21760	524, 578, 685	21865	44, 56, 92, 100	22008	491, 519, 726, 738	22068	384, 554, 578, 675, 712	22120	213
21622	792	21688	729, 792	21761	850	21866	44, 56, 92, 100	22009	497, 519, 725, 738	22069	554, 578, 675, 712	22121	618
21623	782, 817	21689	730, 793	21762	679	21867	486, 518, 683, 781	22011	723	22070	43, 52, 91, 97	22122	356
21624	535, 578, 754, 841	21690	485, 518, 784	21763	668, 695	21868	500, 518, 684, 781	22012	504, 519	22071	479, 519	22123	791
21625	747, 827	21693	452, 518, 750	21764	471, 518, 671, 709	21869	501, 519, 806	22013	720	22072	568, 578, 757, 845	22124	634
21626	474, 518, 831	21694	469, 518, 752	21765	671, 709	21870	500, 519, 684, 808	22014	735	22073	479, 519, 749, 829	22125	524, 579, 754, 840
21627	449, 518, 751, 833	21695	474, 518, 831	21766	671, 709	21871	481, 519, 805, 808	22015	719, 735	22074	116, 149	22126	548, 579, 843
21628	824	21696	480, 518, 705	21767	679	21873	500, 519, 684, 808	22016	722	22075	454, 519, 730, 796	22127	744
21629	810	21697	486, 518, 683, 781	21768	729, 791	21875	528, 578, 806, 808	22017	722, 736	22076	728, 786	22128	793
21630	454, 518, 811	21698	730, 793	21769	668, 695	21877	527, 578, 806, 808	22018	720	22077	541, 578, 785	22129	653
21631	550, 578, 800	21699	485, 518, 784	21770	471, 518, 671, 709	21878	806, 808	22019	719	22078	816	22130	695
21633	472, 518, 731, 798	21702	543, 578, 755, 843	21771	44, 56, 92, 100	21879	806, 808	22020	719	22079	816	22131	691
21634	476, 518, 751, 832	21703	542, 578, 638	21772	668, 695	21880	852	22021	589	22081	43, 53, 91, 97	22133	483, 520
21637	732, 803	21704	471, 518, 671, 709	21773	471, 518, 671, 709	21881	859	22022	590	22082	477, 519, 783	22134	310
21638	494, 518, 707	21705	471, 518, 671, 709	21774	44, 56, 92, 100	21882	806, 808	22023	357	22083	535, 578, 816	22135	721
21639	668, 694	21706	555, 578, 675, 712	21775	452, 518, 763	21884	501, 519, 806	22026	584	22084	681	22136	710
21642	821	21707	471, 518, 671, 709	21776	558, 578, 687	21885	855	22027	594	22085	741	22137	862
21643	475, 518, 751, 831	21708	507, 518, 857	21777	476, 822	21886	860	22028	651	22086	508, 519, 683	22138	862
21644	621	21709	780	21778	518, 807	21887	859	22029	594	22087	688	22140	679
21645	533, 578, 685	21711	526, 578, 775	21779	525, 578, 685	21888	859	22030	44, 55, 91, 99	22088	352	22141	680
21646	732, 803	21712	746, 821	21780	524, 578, 685	21889	859	22031	503, 519	22089	351	22142	680
21647	304	21713	354	21781	486, 518, 683, 781	21890	852	22032	788	22090	504, 519	22143	312
21648	304	21714	350	21782	500, 518, 684, 781	21894	508, 519, 857	22033	634	22091	805	22144	691
		21715	352	21783	668, 695	21895	495, 519, 806, 808	22034	634	22092	805	22145	741
				21784	461, 518, 807	21899	806, 808	22035	618	22093	809	22146	691
				21806	461, 518, 807	21905	459, 519, 807			22094	809	22147	691
				21815	852	21916	495, 519, 806, 808			22095	809		
				21816	852	21917	495, 519, 808			22096	809		
				21818	861	21918	473, 519, 805, 807			22097	809		
				21819	485, 519, 855	21919	805			22098	809		
				21822	498, 519, 806, 838	21920	473, 519, 805, 807			22099	809		
				21824	729, 791	21926	809			22100	809		
				21825	590					22101	809		

NUMERICAL INDEX

Auveco No.	Page No.	Auveco No.	Page No.	Auveco No.	Page No.	Auveco No.	Page No.	Auveco No.	Page No.	Auveco No.	Page No.	Auveco No.	Page No.
22601	296	22712	498,	22773	218, 224,	22860	494, 684	22935	226, 233,	23017	225	23112	281
22602	296		521, 765		228, 238	22861	678		238, 277,	23018	225	23114	281
22603	296	22713	430, 851	22774	222	22862	481, 522,		278, 280	23020	222, 226,	23115	284
22604	362	22714	849	22775	218		683	22936	233, 278		234, 257,	23117	229
22605	362	22715	860	22776	224,	22863	663	22937	281		263, 269	23119	259
22606	362	22716	484,		228, 238,	22864	430	22938	720	23021	226, 228,	23120	219,
22607	363		521, 855	22780	689, 778	22865	116, 150	22939	826		271, 272		245, 268
22608	363	22717	854	22781	541, 686	22866	35, 124	22940	643	23024	254	23121	245
22609	362	22718	451,	22782	476, 682	22868	35, 124	22941	83,	23025	222	23122	245
22610	363		521, 854	22783	688	22869	35, 124		676, 717	23026	234	23123	274
22611	363	22719	851	22784	688	22870	109	22942	83,	23027	224	23124	224,
22612	363	22720	852	22785	678	22871	109		676, 717	23028	243		235, 239
22613	363	22721	851	22786	681	22872	109	22943	676, 717	23029	243	23125	284
22614	363	22722	561,	22787	688	22873	109	22944	749, 829	23032	222, 248,	23126	284
22615	363		580, 859	22788	688	22874	629	22945	50		269, 277	23127	219, 276
22616	363	22723	628	22789	480, 683	22875	470,	22946	43, 52	23033	257	23128	245
22617	363	22724	43,	22790	682	22876	360	22947	109	23034	234, 257	23129	245
22618	363		91, 98	22791	679	22877	360	22948	493,	23035	219	23130	219
22619	363	22725	202	22792	684	22878	360		522, 774	23037	263	23131	220
22620	363	22726	202	22793	494, 521	22879	360	22949	771	23038	228	23132	220
22621	363	22727	202	22794	449	22880	360	22950	492,	23039	258	23134	220, 276
22622	363	22728	202	22796	243	22881	360		522, 776	23040	258	23135	222, 269
22623	363	22729	202	22797	126	22882	360	22951	772	23041	263	23138	239,
22624	363	22730	201	22798	126	22883	360	22952	681, 780	23043	258		265, 274
22625	363	22731	201	22799	126	22884	360	22953	610	23045	277, 283	23139	265, 275
22626	363	22732	201	22800	126	22885	504, 521	22954	300, 860	23046	219, 225,	23141	224
22627	363	22733	201	22801	110	22886	616	22955	184		229, 234,	23142	282
22628	363	22734	201	22802	126	22887	287	22956	184		239, 243,	23144	268
22629	363	22735	201	22803	597	22888	75,	22957	184		252, 254,	23145	235
22630	363	22736	201	22816	810		63, 65	22958	184	23047	264	23146	225
22631	363	22737	201	22818	645	22891	644	22959	184	23048	264	23147	235, 284
22632	363	22738	201	22819	480	22892	681	22960	184	23049	271	23148	282
22633	363	22739	201	22820	803	22893	552, 580,	22961	184	23050	229	23149	285
22634	363	22740	201	22821	487,		686	22962	184	23051	252, 264	23150	285
22635	363	22741	201		673, 696	22894	553, 580,	22963	184	23052	264	23152	202
22636	363	22742	201	22822	690		686	22964	184	23053	226, 234	23153	202
22637	363	22743	201	22823	849	22895	680	22965	184	23054	231	23154	285
22638	364	22744	201	22824	850	22896	803	22966	184	23055	243, 258	23155	275
22639	364	22745	201	22825	850	22897	491,	22967	184	23057	264	23156	220,
22640	364	22746	201	22826	852	22898	522, 730, 787	22968	184		264		222, 225,
22641	365	22747	201	22827	857		466,	22969	184	23058	243		229, 235,
22642	365	22748	201	22828	541,	22899	522, 796	22970	184	23059	244		239, 245,
22643	365	22749	201		543,		486, 522,	22971	184	23061	244		248, 252,
22644	365	22750	201	22830	580, 859		774	22972	184	23062	248		254, 259
22645	365	22751	201		580, 858	22900	451, 522	22973	184	23064	244, 254,	23157	229, 239
22646	365	22752	201	22831	791	22901	522, 776	22974	184		259, 264	23158	225
22647	365	22753	201	22832	502,	22902	770	22975	204	23065	239	23167	192
22648	365	22754	201		731, 797	22903	430, 802	22976	204	23071	229, 254,	23168	252, 265
22649	365	22755	201	22833	788	22904	802	22977	204		272, 278	23169	265
22650	366	22757	64,	22836	586	22905	485,	22978	204	23072	271	23171	266
22651	366		67, 86	22837	586		522, 774	22979	204	23073	268, 272	23175	267
22652	366	22758	760	22838	116, 151	22906	81, 87	22980	204	23074	284	23179	229
22653	366	22759	580, 858	22839	117, 152	22907	810	22981	204	23076	264	23180	265
22654	366	22760	464, 521	22840	486	22908	81, 88	22982	204	23078	270	23181	222, 235,
22655	366	22761	802		645	22909	663	22983	204	23079	226		240, 248,
22656	366	22762	566,	22841	116, 150	22910	492, 522	22984	204	23080	226		259, 266
22657	366		580, 801	22843	757, 848	22911	584	22985	204	23081	231	23182	266
22658	367	22763	793	22844	645	22912	632	22986	204	23089	298, 612	23183	273, 275
22659	368	22764	499,	22845	501,	22913	107	22987	204	23090	239, 274	23184	231
22699	117, 153		522, 797		754, 840	22914	630	22988	204	23092	231	23186	255
22700	117, 152	22765	550,	22846	589	22915	81, 88	22989	204	23095	271	23187	285
22701	628		580, 863	22847	111, 690	22916	630	22991	184	23096	222, 248,	23188	285
22702	116, 149	22766	729, 791	22848	563,	22917	342, 691	22992	184		269, 277	23189	285
22703	567,	22767	486, 787		580, 686	22918	860	22993	184	23098	250	23190	220,
	580, 715	22768	492,	22849	852	22919	803	22994	480, 521	23100	244		230, 235
22704	697		731, 797	22850	861	22920	527, 580	22995	355	23101	244	23191	249
22705	454,	22769	467,	22851	802	22921	778	22997	872	23102	244	23192	249
	522, 811		731, 794	22853	493, 683	22922	771	22998	297	23103	244	23193	255
22706	815	22770	233, 237	22854	687	22923	341, 352	22999	301	23104	244	23195	245
22708	757, 847	22771	231,	22855	535,	22924	458, 522	23009	238	23106	245	23196	231,
22709	757, 847		255, 272		580, 686, 781	22926	670, 702	23010	202		245		255, 272
22710	549,	22772	218,	22856	554, 659	22927	450, 522	23012	228	23107	268	23198	271, 273
	580, 775		228, 238		580	22928	629	23013	219	23109	281	23199	249
22711	854			22857	669, 698	22929	653	23014	219	23110	281	23200	245
				22858	681, 780	22930	633	23015	219	23016	234, 257		
				22859	530,	22931	219						
					580, 685, 781	22932	228, 233						
						22933	232						

NUMERICAL INDEX

Auveco No.	Page No.	Auveco No.	Page No.	Auveco No.	Page No.	Auveco No.	Page No.	Auveco No.	Page No.	Auveco No.	Page No.	Auveco No.	Page No.
23201	246, 259, 266	23546	285	23713	126	23836	44, 92	23952	678	24112	24	24232	332
		23547	285	23714	171	23837	43, 90	23954	580, 602	24115	124	24233	311
23202	259	23548	285	23718	632	23838	43, 91	23955	630	24116	126	24235	318
23203	266	23552	489, 522	23719	42	23841	42, 90	23956	436	24119	24	24236	319
23204	260	23553	489, 522	23720	588	23847	44, 91	23958	534,	24120	132	24237	315
23206	260	23555	698	23721	652	23850	45		580, 841	24123	121	24239	311
23208	252	23559	503,	23723	437, 588	23851	794	23959	550, 580	24124	121	24240	312
23209	255,		522, 839	23724	581	23852	111, 689	23961	522,	24125	183	24241	314
	273, 282	23560	825	23725	625, 626	23853	788		590, 816	24126	124	24242	314
23210	231	23563	613	23726	625	23855	80, 85	23962	522, 816	24128	118	24243	322
23211	224	23567	884	23727	625	23856	439	23965	589	24130	24	24244	322
23212	252, 266	23576	884	23729	825	23859	522	23966	462, 522	24131	24	24245	322
23213	246	23577	884	23730	652	23860	434	23968	647	24132	24,	24246	322
23214	246	23578	884	23734	580	23861	350	23970	353		43, 91	24248	313
23215	246	23580	885	23736	625	23864	45	23971	650	24134	21	24250	329
23216	246	23581	43, 54	23737	474,	23866	439	23973	350	24135	21	24251	329
23217	246	23582	437		522, 794	23867	43	23975	348	24137	21	24252	329
23218	246	23587	71	23738	530,	23868	63, 65	23978	673, 706	24139	23	24253	329
23219	246	23588	42, 46		580, 841	23869	42, 90	23982	663	24140	23	24254	329
23220	282	23589	864	23742	625	23870	631	23984	874	24141	435	24255	329
23221	223	23591	884	23745	522	23871	631	23985	63, 65	24142	435	24256	329
23222	268	23592	467, 522	23752	474,	23872	436	23989	498, 522,	24143	435	24257	320
23223	268	23597	42, 46		522, 794	23876	46,		731, 797	24144	435	24259	316
23226	235	23608	451, 521	23753	626		90, 94	23992	342	24145	437	24261	319
23228	681, 772	23610	42	23754	625,	23877	437	23993	557	24147	613	24262	319
23229	220,	23615	883	23755	626	23878	127	23995	435	24149	626	24263	316
	247, 269	23617	613	23758	45	23879	127	23996	435	24150	626	24264	319
23230	220, 247,	23619	23	23761	623	23880	127	23997	435	24156	440	24265	315
	269, 276	23626	439	23775	22	23882	127	24001	156	24160	580, 660	24266	312
23231	221, 247,	23627	439	23777	22	23883	169	24002	156	24162	463, 522	24267	313
	269, 276	23628	19	23778	22	23884	458, 522	24003	156	24163	63, 66	24268	312
23232	282	23629	19	23782	460, 522,	23885	650	24005	31	24164	126	24269	318
23233	282	23637	652		854	23887	883	24006	126	24165	126	24270	331
23234	282	23639	299	23783	488,	23888	645	24009	126	24166	21	24271	315
23237	273	23640	631		522, 806	23891	560, 580	24011	126	24167	126	24272	331
23252	240	23646	587	23784	117	23893	42	24013	125	24168	38	24273	331
23254	240	23649	587	23785	435, 847	23895	649	24016	142	24169	443	24274	331
23256	221, 230	23652	37	23786	443,	23896	462, 522	24018	167	24170	437	24278	330
23259	231	23653	81		615, 646	23898	636	24020	144	24171	42, 46	24279	330
23260	230, 240	23654	81	23789	80	23899	564, 580	24024	424	24172	44, 92	24280	330
23261	240	23655	109	23790	699	23900	80, 83	24027	424	24173	93	24281	330
23262	240	23656	109	23792	24,	23901	696	24029	23	24174	38	24282	330
23263	285	23657	652		42, 90	23902	525,	24033	19	24175	42, 48	24283	330
23264	285	23659	636	23793	43,		580, 685	24034	155	24176	44, 91	24284	330
23265	230	23661	81		53, 91	23904	434	24035	156	24177	38	24285	330
23268	236	23662	38	23794	42, 90	23905	434	24044	169	24178	42	24286	330
23269	249, 255,	23663	38	23795	42, 50	23906	435	24047	186	24179	616	24287	331
	260, 270,	23664	38	23796	81	23907	522	24048	78	24180	126	24288	331
	272, 273	23665	38	23799	42, 47	23909	46,	24049	73	24181	455, 522	24289	331
23271	260, 273	23666	38	23801	80		90, 94	24050	73	24183	43,	24292	312
23275	227	23671	110	23802	451, 522	23910	118	24051	73		52, 91	24293	313
23276	285	23676	588	23803	45	23911	118	24053	126	24191	185	24294	312
23277	273	23677	63, 67	23805	21	23914	118	24054	126	24193	73	24295	312
23278	277	23679	436	23806	19	23915	118	24055	126	24202	223,	24296	309
23280	67	23683	490, 521	23807	522, 733	23918	118	24056	125		249, 260	24298	309
23283	67	23684	109	23808	80	23919	118	24057	185	24203	810	24299	309
23285	649	23685	109	23809	42, 90	23921	118	24058	179	24207	329	24300	309
23286	581, 627	23686	109	23810	884	23924	118	24060	179	24208	329	24301	309
23287	581	23688	80	23811	80	23926	118	24063	157	24210	329	24302	309
23288	627	23689	80, 86	23814	42,	23927	118	24066	145	24211	330	24303	309
23298	883	23692	38		49, 90	23928	118	24070	161	24212	329	24304	309
23309	581	23694	547, 580	23817	81	23929	118	24072	161	24213	330	24305	309
23310	581	23695	45, 93	23818	613,	23930	118	24074	161	24214	329	24306	308
23391	172	23696	438		630, 768, 817	23932	633	24075	161	24217	329	24307	308
23437	230, 255	23698	91	23822	580,	23933	452, 522	24076	161	24218	319	24308	308
23442	118	23699	630		600, 637	23935	580, 840	24077	161	24219	318	24309	308
23461	617	23700	494,	23826	539,	23936	435	24079	161	24221	320	24310	308
23495	36		522, 797		580, 600	23937	522	24080	127	24222	321	24311	308
23497	37	23702	598, 864	23828	817	23939	358	24083	166	24224	332	24312	308
23502	63, 68	23706	44	23830	80	23943	541,	24087	204	24225	332	24313	306
23503	63, 68	23708	632	23831	587		580, 842	24097	890	24226	332	24314	306
23504	64, 66	23709	648	23833	42, 90	23944	434	24098	204	24227	332	24315	306
23505	64, 66	23710	431	23834	42,	23945	113, 848	24103	145	24228	311	24316	306
23527	144	23711	81		49, 90	23948	828	24110	24	24229	311	24317	306
23530	110	23712	171	23835	44, 91	23951	678	24111	24	24230	315	24318	306

NUMERICAL INDEX

Auveco No.	Page No.	Auveco No.	Page No.	Auveco No.	Page No.	Auveco No.	Page No.	Auveco No.	Page No.	Auveco No.	Page No.	Auveco No.	Page No.
24319	306	24473	56	25034	770	25101	43, 53,	25175	207	25256	670, 701	25334	481,
24320	306	24474	356	25035	112,	25102	91, 98	25176	207	25257	480,	25335	523, 742
24321	306	24475	52,		779		208	25178	530,	523, 764			532,
24322	306		91, 97	25036	849	25103	208		580, 640	25258	59,	25336	580, 776
24323	306	24476	623	25037	770	25104	208	25179	667		92, 103		770
24324	306	24479	80, 83	25038	777	25105	208	25180	590	25259	554,	25337	480, 523,
24325	306	24480	57,	25039	770	25106	208	25181	595		756, 848		752, 835
24326	306		92, 100	25040	772,	25107	208	25182	522	25260	487,	25338	548, 580,
24327	306	24481	353		773	25108	358	25183	614		523, 855		756, 843
24328	306	24484	467, 522	25045	117,	25109	358	25184	662	25261	112,	25339	468,
24329	306	24486	52		153	25110	358	25185	477, 523		145, 861		523, 853
24330	306	24489	80, 84	25046	322	25111	358		795	25262	676, 717	25340	507,
24331	307	24495	54,	25047	322	25112	667	25188	116	25263	486,		523, 857
24333	307		91, 98	25048	322	25113	636	25189	632		523, 856	25341	350
24336	307	24497	300	25049	644	25114	762	25190	614	25264	689	25342	111, 689
24337	307	24500	81, 88	25050	470,	25115	671, 702	25192	260, 279	25265	663	25343	508, 523
24338	307	24502	81, 89		522	25116	770	25193	586	25266	620	25344	771
24339	307	24504	85	25051	586	25117	483,	25194	499, 523	25267	670, 701	25345	746, 824
24341	307	24505	85	25052	610		522, 863	25196	810	25268	717	25346	479, 523,
24342	303	24507	140	25053	430,	25118	811	25198	727, 740	25269	496,		749, 829
24343	302	24510	440		620	25119	425	25199	727, 740		674, 708	25347	472,
24344	302	24511	624	25054	611	25120	425	25202	44,	25270	743		523, 784
24345	302	24514	877	25055	670,	25121	425		58, 101	25271	589	25348	647
24347	310	24515	85		702	25122	425	25203	44, 57,	25272	502	25349	653
24348	303	24517	54, 91	25056	762	25123	425		92, 102	25273	615	25350	644
24350	303	24519	648	25057	114,	25124	425	25204	94	25274	615	25351	480, 523
24351	303	24521	140		780	25125	425	25206	562,	25275	614, 663	25352	644
24354	303	24522	114, 769	25058	569,	25126	425		580, 660, 785	25276	615	25354	633
24355	303	24523	114, 769		580,	25127	425	25210	227, 236,	25277	645	25356	21
24356	303	24525	617		778	25128	425		278, 279	25278	645	25357	21
24361	303	24529	53,	25059	773	25129	425	25211	230	25279	614, 646	25359	21
24362	303		91, 98	25060	771	25130	425	25214	580, 777	25280	645	25360	21
24364	304	24531	124	25061	771	25131	425	25215	493,	25281	645	25362	21
24365	304	24533	524,	25063	693	25132	425		523, 774	25282	645	25364	21
24366	304		580, 710	25064	670,	25133	889	25216	555,	25283	486, 523	25365	21
24367	304	24538	54,		702	25135	361		580, 777	25284	667	25366	21
24368	304		91, 98	25065	470,	25136	361	25217	628, 651	25285	355,	25368	21
24369	304	24542	648		522,	25137	361	25218	567, 580		359, 667	25374	21
24370	304	24545	107		671, 710	25138	361	25219	456, 523	25286	667	25375	21
24371	304	24549	624	25066	669,	25139	361	25220	665	25287	666	25377	21
24372	304	24575	587		699	25140	361	25221	611	25289	635	25378	21
24373	304	24576	357	25067	692	25141	361	25222	558,	25290	633	25380	21
24374	304	24580	456, 522	25068	677,	25142	361		580, 777	25291	276	25381	21
24375	304	24581	622		716	25143	361	25223	665	25292	247	25383	21
24376	304	24584	662	25069	673,	25144	361	25224	84, 676	25293	247	25384	21
24377	309	24588	363		706	25145	361	25225	44, 58,	25295	64, 67	25386	21
24426	109	24589	51,	25070	716	25146	361	25226	45, 60,	25296	247	25388	21
24427	55,		90, 96	25071	762	25147	425		93, 104	25309	171	25389	21
	92, 99	24595	627	25072	468,	25148	425	25228	113	25310	82	25390	21
24428	51,	24606	629		522, 763	25149	742	25229	115	25311	82	25392	21
	90, 97	24613	434	25073	768	25150	43, 54,	25230	115	25312	82	25394	21,
24430	110	24617	613,	25074	762		91, 98	25231	113	25313	82		44, 57,
24433	25		645, 662	25075	450, 522,	25151	666	25232	112	25314	853		92, 102
24434	109	25001	643		750, 830	25152	667	25233	111	25315	112	25395	21,
24436	126	25007	46, 94	25076	478, 522,	25153	666	25234	111	25316	493, 523		44, 57,
24438	126	25016	208		751, 833	25154	351	25235	112	25317	44, 58,		92, 101
24441	59,	25017	208	25077	116	25155	490, 522	25237	45, 61,		92, 101	25396	21, 689
	93, 103	25018	208	25078	45, 61,	25156	490, 522		93, 104	25318	689	25397	44, 57,
24442	61,	25019	184		93, 105	25157	282	25238	44,	25319	568,		92, 102
	93, 104	25020	184	25079	669, 698	25160	223,		58, 101		580, 685	25398	681
24447	357	25021	184	25080	778		249, 277	25239	75,	25320	678	25399	680
24450	51,	25022	206	25081	778	25161	273, 279		63, 65	25321	678	25400	680
	90, 96	25023	206	25082	771	25162	279	25240	213	25322	682	25401	679
24458	51,	25024	208	25084	307	25163	205	25241	213	25324	554,	25402	780
	90, 96	25025	208	25085	480, 522	25164	205	25242	213		580, 659	25403	679
24462	649	25026	208	25088	628	25165	205	25243	213	25325	616	25404	680
24465	50,	25027	208	25089	503, 522	25166	205	25244	490, 523	25326	668, 693	25405	681
	90, 96	25028	208	25090	636	25167	205	25248	490, 523	25327	677, 716	25406	688
24466	61,	25029	208	25091	504, 522	25168	205	25249	492, 523	25328	477, 523,	25407	617
	93, 104	25030	771	25092	115,	25169	205	25250	113, 145		672, 705	25408	677, 715
24467	53,	25031	559,		732, 804	25170	205	25251	350	25329	696	25409	44, 56,
	91, 98		580, 687	25093	497,	25171	207	25252	688	25330	677, 716		92, 100
24469	471, 522	25032	493,		522, 684	25172	207	25253	662	25331	846	25411	116,
24471	63,		522, 773	25094	682	25173	207	25254	676, 717	25332	847		145, 769
	65, 75	25033	585	25099	760	25174	207	25255	696	25333	736	25412	798, 528

NUMERICAL INDEX

Auveco No.	Page No.	Auveco No.	Page No.	Auveco No.	Page No.	Auveco No.	Page No.	Auveco No.	Page No.	Auveco No.	Page No.	Auveco No.	Page No.
25413	824	6609BHM	377,	B2827	290	FP-224	418						
25414	853		381, 382	B3057	290	FP-232	418						
25415	854	6610BHM	377,	B3057A	290	FP-233	418						
25416	615		381, 382	B3156	290	FP-247	419						
25419	680	6611BHM	377,	B3156A	290	J01973	581, 627						
25420	568,		381, 382	B3157	290	J06260	118						
	580, 686	6612BHM	377,	B3157A	290	J06723	285						
25421	590		381, 382	B3357	290	MB-36	387						
25422	720	6613BHM	377,	B3457	290	P277	387						
25423	719, 720		381, 382	B3457A	290	P40-S	387						
25424	741	6614BHM	378	B4157	290								
25425	743	6615BHM	378	B4157K	290								
25426	742	6616BHM	378	B5007	290								
25427	772	6617BHM	378	B5008	290								
25428	783	6618BHM	378	B53	290								
25429	746, 824	6619BHM	378	B57	290								
25430	748, 826	6628BHM	379	B6411	290								
25431	747, 825	6629BHM	378	B6413	290								
25432	747, 828	6630BHM	379	B64132	292								
25433	617, 651,	6631BHM	379	B6418	290								
	747, 826	6632BHM	379	B67	290								
25434	758, 849	6633BHM	379	B68	290								
25435	758, 848	6635BHM	379	B7225	290								
25439	80, 83	6649BHM	378	B7440	290								
25474	648	6650BHM	376	B7440A	290								
35096	385, 395	68-118	407	B7443	290								
35156	385, 395	68-12	407	B7443A	290								
0-Boxes	889	68-18	407	B7505	290								
1-900	385, 395	68-6	407	B7506	290								
1-900L	386	68-RACK	407	B7507	290								
1-900S	384	69-12	401	B7528	290								
1-901	385, 395	69-18	401	B880	291								
1-901 DIVIDERS		69-24	401	B881	291								
	385	69-RACK	401	B886	291								
1-902	395	7-SBoxes	889	B89	290								
1-912	385, 395	71-3438	581	B891	291								
1-912L	386	9-D	387	B893	291								
1-916	385, 395	93-7131	219	B894	291								
1-916INSERT		99-7938	118	B896	291								
	395	99-7939	118	B9004	291								
1-916L	386	99-7940	118	B9005	291								
1-920	385, 395	99-7943	118	B9006	292								
1-920L	386	99-7944	118	B9007	292								
1-924	385, 395	99-7945	118	B906	290								
1-924L	386	99-7949	118	B906A	290								
1-932	385, 395	99-7950	118	B912	290								
1-ACC	387	99-7956	118	B916	290								
1-Boxes	889	99-7958	118	B916A	290								
1-MBC	386	99-7960	118	B921	290								
1-WSR	386	99-7961	118	B921A	290								
18-D	387	99-7963	118	B97	290								
2-600S	384	AP448-CK	375	BH1	292								
2-608	384	AP448-GP	375	BH10	292								
2-612	384	AuvecoPak	369	BH11	292								
2-616	384	B-1	387	BH13	292								
2-624	384	B-2	387	BH3	292								
2-Boxes	889	B1141	290	BH7	292								
3-96R	385, 395	B1156	290	BH9	292								
3-Boxes	889	B1156A	290	BHDB-1	376								
4-Boxes	889	B1157	290	DB-428L	388								
65-1097	581,	B1157A	290	Dividers	387								
	627	B168	290	FP-100	417								
6600BHM	376	B1893	290	FP-102	417								
6601BHM	376	B1895	290	FP-104	417								
6602BHM	376	B194	290	FP-108	417								
6603BHM	376	B194-100	290	FP-123	418								
6604BHM	376	B194A	290	FP-131	418								
6605BHM	377,	B2057	290	FP-132	418								
	380, 381	B2057A	290	FP-159	419								
6606BHM	377,	B2357	290	FP-160	419								
	380, 381	B2357A	290	FP-163	419								
6607BHM	377,	B24	290	FP-168	419								
	381, 382	B2721	290	FP-171	419								
6608BHM	377,	B2722	290	FP-188	420								
	381, 382, 383	B2821	290	FP-210	419								

O.E.M. INTERCHANGE BY MANUFACTURER

OEM No.	Auveco No.	Page No.	OEM No.	Auveco No.	Page No.	OEM No.	Auveco No.	Page No.	OEM No.	Auveco No.	Page No.
211-2	16913	286	07-12-9-904-224	13218	112	51-12-7-046-911	22788	688	51-48-9-119-216	22782	476, 682
212-2	18011	286			690, 779	51-12-7-070-202	22113	116,	51-49-0-151-605	22057	481,
2357	17999	286	07-12-9-925-708	13223	111,		149, 150, 690, 861				519, 683
2357NA	18000	286			690, 779	51-12-7-070-202	22841	116,	51-49-7-054-228	22862	481,
2396	17998	286	07-12-9-925-720	13162	114,			150,			522, 683
24	18017	286			690	51-12-7-461-407	22858	681,	51-49-8-105-790	22057	481,
3057	16915	286	07-12-9-925-737	13218	112,			780			519, 683
3057NA	16916	286			690, 779	51-12-7-488-348	25399	680	51-49-8-123-832	22057	481,
3155	17997	286	07-13-0-702-966	17267	556,	51-12-7-488-355	25419	680			519, 683
3156	17996	286			572, 676	51-12-7-488-356	25400	680	51-49-8-166-702	22201	528,
3156NA	18475	287	07-14-3-448-498	18156	64,	51-13-1-804-205	13158	678			579, 685
3157	16917	286			689	51-13-1-829-904	21767	679	51-49-8-237-075	22855	535,
3157NA	18001	286	07-14-6-949-380	25264	689	51-13-1-885-399	25319	568,			686, 781
3157SA	18479	287	07-14-6-951-655	25342	111,			580, 685	51-71-1-928-946	23902	525,
3357	18477	287			689	51-13-1-934-160	22202	680			580, 685
3357NA	18478	287	07-14-6-962-771	22285	495,	51-13-1-946-258	25401	679	51-71-1-958-025	20645	778
3457	20587	287			520, 781	51-13-1-960-054	21429	679	51-71-1-958-025	22087	688
3457NA	20588	287	07-14-6-963-883	22110	44,	51-13-6-440-146	21767	679	51-71-1-959-929	25404	680
3496	20296	287			55, 92, 99	51-13-7-065-607	22789	480,	51-71-7-002-953	20754	341
37	18465	286	07-14-6-974-274	22786	681			683	51-71-7-006-757	22140	679
4157LL	20620	287	07-14-6-976-114	22298	681	51-13-711-7-240	22791	679	51-71-7-048-316	25322	682
4157NALL	20621	287	07-14-6-981-767	22260	861	51-13-7-269-358	22792	684	51-71-7-066-220	22141	680
53	16914	286	07-14-7-122-912	22086	508,	51-13-7-269-367	22785	678	51-71-7-066-223	22142	680
55	20282	287			519, 683	51-13-7-291-271	25403	679	51-71-7-066-226	22092	508,
561	18010	286	07-14-7-122-913	21854	508,	51-13-8-166-675	21432	679			519, 683
57	16910	286			519, 682	51-14-1-807-495	22892	681	51-71-7-066-299	22091	508,
63	20283	287	07-14-7-129-160	22030	44,	51-14-8-209-932	22790	682			519, 682
631	18468	286			55, 91, 99	51-16-1-881-149	20187	525,	51-71-7-154-239	25405	681
67	16905	286	07-14-7-129-161	22030	44,	51-16-1-881-149	20187	525,	51-71-7-154-520	22784	688
68	20292	287			55, 91, 99	51-16-1-943-122	22783	688	51-71-8-108-613	23952	678
73	20284	287	07-14-7-129-161	22030	44,	51-16-8-197-908	22303	527,	51-71-8-195-811	25420	568,
74	18016	286			55, 91, 99			579, 685, 781			580, 686
7440	19206	287	07-14-7-133-419	22793	560,	51-18-1-821-830	18156	64,	51-71-8-218-852	25252	688
7443	19207	287			684			65	51-71-8-234-698	25093	497,
7444NA	22887	287	07-14-7-146-367	25394	21,	51-21-8-205-295	20388	556,			522, 684
881	20595	288			44, 57, 92, 102	51-41-0-407-983	22229	500,	51-71-8-259-025	22559	679
886	20683	288	07-14-7-151-963	25395	21,			575, 687	51-75-7-271-848	22084	681
889	16911	286			44, 57, 92, 101	51-41-0-407-984	21788	500,	51-77-7-171-002	21787	486,
891	20598	288	07-14-7-154-227	25396	21,			520, 684			518, 683, 781
893	20599	288			689	51-41-0-407-984	21788	500,	51-77-7-171-004	22147	691
90	18015	286	07-14-7-169-847	22780	689,	51-41-1-870-718	22585	505,	51-77-7-891-250	22597	679
9003	18661	288			778			521, 683	52-20-1-964-201	22521	457,
9004	16896	288	07-14-7-201-307	22084	681	51-41-1-973-500	20253	506,			521
9005	16897	288	07-14-7-212-877	22822	690			514, 684, 775	52-20-8-133-466	22794	449
9006	16898	288	07-14-7-213-303	22781	541,	51-41-7-067-920	25203	44,	61-13-8-350-827	22854	687
9007	18662	288			686			57, 92, 102	63-17-1-637-868	20647	772
904	20291	287	07-14-7-236-400	25094	682	51-41-7-325-082	22853	493,	63-21-7-160-777	BH1	292
906	16922	286	07-14-7-265-039	22952	681,			683	63-21-7-160-779	BH3	292
912	18008	286			780	51-41-8-172-050	13179	505,	63-21-7-160-781	BH7	292
916	18006	286	07-14-7-281-961	22848	563,			509, 683, 856	63-21-7-160-784	BH11	292
916NA	18007	286			686	51-41-8-224-768	21788	500,	63-21-7-160-785	B9005	291
921	18005	286	07-14-7-293-278	22146	691			518, 684, 781	63-21-7-160-786	B9006	292
922	20294	287	07-14-7-296-886	22509	467,	51-41-8-224-781	22229	500,	63-21-7-190-591	BH13	292
93	16926	286			521, 682			520, 684	72-11-1-917-406	25406	688
97	16912	286	07-14-7-311-312	22847	111,	51-43-0-141-025	22229	500,			
					690			520, 684			
			07-14-7-336-362	22787	688	51-43-7-001-491	21873	500,			
			07-14-7-378-241	22917	342,			519, 684, 808			
			07-14-7-391-323	22144	691	51-43-7-194-187	22109	689			
			07-14-7-391-324	22131	691	51-44-7-780-135	21499	682,			
			07-14-7-401-727	22894	553,			772			
			07-14-7-443-710	22860	580, 686	51-46-7-002-606	21779	525,			
			07-14-7-460-560	25316	494,			578, 685			
					493,	51-46-7-453-747	22819	480			
			07-14-9-126-885	25317	523	51-47-0-146-782	20638	555,			
					58, 92, 101			575, 686, 777			
			07-14-9-126-886	25397	44,	51-47-0-390-017	20638	555,			
					57, 92, 102			575, 686, 777			
			07-14-9-213-164	25202	44,	51-47-1-840-961	25320	678			
					58, 101	51-47-1-911-992	20638	555,			
			07-14-9-248-255	25398	681			575, 686, 777			
			11-13-1-250-089	24248	313	51-47-1-919-209	22052	557,			
			11-13-1-273-093	24248	313			578, 687			
			11-13-7-553-918	24248	313	51-47-7-117-532	22090	504,			
			11-13-7-585-928	24235	318			519, 684			
			11-13-7-605-018	22344	320,	51-47-8-166-992	21780	524,			
					534, 579, 603			578, 685			
			16-13-1-176-747	21431	688,	51-47-8-234-047	25321	678			
					778	51-47-8-244-458	22861	678			
			16-13-6-753-087	22859	530,	51-48-1-884-779	22710	549,			
					580, 685, 781			580, 775			
			17-11-1-712-963	22596	532,	51-48-1-915-964	20270	550,			
					579, 685			575, 687			
			46-63-7-659-479	25204	94	51-48-1-915-964	22893	552,			
			51-11-1-908-077	20234	533,			580, 686			
					575, 685, 775	51-48-1-938-725	20270	550,			
			51-11-1-944-537	20734	556,			575, 687			
					575, 687	51-48-7-273-379	22782	476,			
			51-11-1-964-186	22401	534,			476,			
					579, 686	51-48-8-126-849	22524	681			
			51-11-7-071-270	25318	689	51-48-8-181-420	21757	476,			
			51-11-8-174-185	20248	557,			682			
					575, 687	51-48-8-252-749	22895	680			
			51-12-7-004-445	21778	578, 687						

AVDEL/CHERRY

2771-0613	17425	346
2771-0817	17427	346
2774-0613	17421	

O.E.M. INTERCHANGE BY MANUFACTURER

OEM No.	Auveco No.	Page No.	OEM No.	Auveco No.	Page No.	OEM No.	Auveco No.	Page No.	OEM No.	Auveco No.	Page No.
L0000881	B881	291	1758099	12960	865	4005091	18296	43,	4717224	19855	457,
L0000886	B886	291	1900654	9361	443			52, 53			514
L0000891	B891	291	1BA41AX1-AA	20763	653	4005099	11349	505,	4728204	23123	274
L0000894	B894	291	1BA41XWG-AA	21175	653			509	4753738	24343	302
L0000896	B896	291	2072728	8746	129	4005250	11350	464,	4762490	23895	649
L0000906	B906	290	2074089	8971	883			509	4778578	24257	320
L0000912	B912	290	2074089	23298	883	4005470	11678	506,	4784018-AA	21231	650
L0000911	BH11	292	2096466	14892	196			509	4805405-AA	19638	568,
L0000913	BH13	292	2096467	15504	196	4005540	11152	436,		573, 640,	661
L0001156	B1156	290	2217508	23563	613			437	4805405-AB	19638	568,
L0001157	B1157	290	2409826	8742	129	4006204	11470	581,		573, 640,	661
L0001893	B1893	290	2448770	16873	873,			665	4806226-AA	21187	613
L0001895	B1895	290			874	4006204	23309	581	4806240-AA	20768	547,
L0002057	B2057	290	2496279	9905	214,	4006316	13965	141		576,	658
L0003057	B3057	290		215, 267, 280		4006516	11612	451,	4806240-AB	20768	547,
L0003156	B3156	290	2534814	14461	883			509		576,	658
L0003157	B3157	290	2664040	14985	467,	4006529	15040	455,	4806271-AA	22028	651
L0003157AK	B3157A	290			510, 661			510	4806334-AA	20963	567,
L0003457	B3457	290	2926502	23155	275	4006848	12943	173		576,	660
L0007440	B7440	290	2945109	14967	619,	4019472	12943	173	4814094	25223	665
L0007440NA	B7440A	290		647, 662, 665		4023030	4204	430	4856641	24285	330
L0007443	B7443	290	2945109L	14967	619,	4033711	14552	664	4856880	10733	128
L0009004LL	B9004	291		647, 662, 665		4040732	18509	468,	4857108	17103	534,
L0009005	B897	288						512		572, 603,	640
L0009005	B9005	291	2964547	11129	449,	4055028	13542	267	4857182AA	25219	456,
L0009006	B898	288			509	4095145	12929	171			523
L0009006	B9006	292	2983727	23078	270	4100727	12932	173	4857327AA	23107	268
L0009006XS	B898	288	2998430	10332	460,	4104998	12937	171	4857345-AA	20457	560,
L0009007QL	B862	288			509	4114785	12134	444		575,	659
L0009007QL	B9007	292	3201767	13966	141,	4124081	20389	268	4857699-AA	20771	655
L0009145	BH10	292			807	4124721	12598	267	4857753-AA	20359	547,
L000921E	B921	290	3236813	12927	172	4167810	12920	172		575,	605
L00194NA	B194A	290	3237451	12949	173	4179981	12946	171	4860198	10330	583
L002057A	B2057A	290	3239826	12935	171	4179982	12944	173	4860375-AB	20667	650
L003057K	B3057	290	34201287	16826	63,	4200408	15326	109	4860379-AA	21026	458,
L003157K	B3157	290			67, 80, 84	4201198	12934	171			516
L003457-K	B3457	290	34201358	15331	109	4209695	23155	275	4878883-AA	17004	466,
L004157NAK	B4157K	290	34201621	12567	539,	4241054	12939	173			511
L00H355W	20600	288			570, 602, 657	4241296	12930	171	4878883-AA	20164	466,
L00H355W	BH3	292	34201631	18108	341	4241362	12916	172			514
L01255H3	20600	288	34202672	13993	540,	4270974	11369	64,	4882723	11120	450,
L09005LL	B9005	291			570, 604, 640			67			509
MB132008	14335	782,	34202787	15478	462,	4304729	16804	195	4897087AA	23198	271,
		790			510	4307218	12943	173			273
MB153825	17195	630,	3426388	2272	443,	4336115	17167	664	5012874-AA	19628	502,
	651, 692, 733, 782,				665	4339372	21022	438			513
MB253964	17351	538,	3441734	12930	171	4341060	17004	466,	5013984AA	23073	268,
		572, 785	3441743	12930	171			511			272
MB325299	16671	847	3454220	15673	620,	4368618	15499	191	5014002-AA	23269	249,
MB374270	21118	498,			662	4370138	17101	342		255, 260, 270, 272, 273	
		516, 784	3454221	15674	620,	4381395	20316	461,	5014003-AA	23271	260,
MB374271	21118	498,			662			514			273
MB475404	17162	532,	3509575	9905	214,	4389947-AA	21376	563,	5017124AB	23072	271
		572, 601, 841			215, 267, 280			577	5017410-AA	14021	450,
MB547806	17472	557,	3513686	13542	267	4399576	20389	268			510
		572, 785, 801	3574085	11653	649	4399900	23222	268	5019910-AA	23181	222,
MB566719	19802	488,	3588314	13541	216,	4400448	23144	268		235, 240, 248, 259, 266	
		514			267	4400588	13542	267	5023111-AA	19804	505,
MB566720	19334	485,	36003452	13454	453,	4400741	23144	268			514
		513, 784			509	4428987	19155	466,	5023173-AA	20563	504,
MB608104	19129	502,	3671410	12918	172			513			515
		513, 839	3673945	12918	172	4437565	12237	215,	5023351-AA	19804	505,
MB608104	23559	503,	3691590	10831	457,			241			514
		522, 839			509	4453429	12569	627,	5028438-AA	20428	503,
MB696120	19320	481,	3691590	16259	457,			649			515
		513, 784			511	4486948	11157	215,	5073327-AA	20187	525,
MB888869	19140	558,	3693099	14217	612,			267		573, 775,	857
	573, 599, 656,				643, 665	4498100	14552	664	5080631AA	24261	319
	676, 785, 845		3744750	12237	215,	4580779	14011	537,	5080631AB	24261	319
MR200300	20247	542,			241			570, 602	509712AB	24286	330
		575, 711, 785	3751212	12923	171	45998051	12119	110	5103921-AA	20637	551,
MR328954	19274	551,	3764863	12599	267	4630088	18031	341			575, 776
		573, 800	3764865	12598	267	4630088	18028	341	5113015-AA	18032	526,
MS820959	16897	288	3767196	18979	434	4630660	18028	341			572, 655
MU000695	25206	562,	3793876	18979	434	4630660	18031	341	5113360-AA	20529	586
		580, 660, 785	3799089	14858	661	4636358	23144	268	5116530-AA	20966	545,
MU001220	25206	562,	381090	23657	652	4636360	18921	268			576, 658
		580, 660, 785	3843245	12598	267	4638136	14753	540,	5116530-AA	20990	548,
			3843345	12628	202		571, 601, 638, 656			576, 606,	659
N0138128	24330	306	3843386	16349	195	4638136	14993	540,	5116530-AA	21680	541,
N0138178	24330	306	3843392	12627	202			571, 776			656
OWX68BD5-AA	21021	561,	3843432	13233	267	4638136	23826	539,	5159077-AA	20964	651
		576, 657	3861577	11347	453,			580, 600	5159077-AB	20964	651
TY98TL2-AA	20541	465,			509	4658444	19191	662	5160260-AA	20966	545,
		515	3861577	11679	453,	4658673	19149	451,			576, 658
WX68BD1-AA	20948	561,			509			513	5183448AA	23135	222,
		576, 657	4000141	11697	665	4658677	14967	619,			269
WX68DX9-AA	20739	561,	400141	9829	583			647, 662, 665	5183468-AA	19472	610,
		575, 657	4001916	18508	473,	4658887	20165	449,			643
XX10362-20-K1105	7680	448			512			514	5189180-AA	21154	653
OWX68XDB-AA	21427	561,	4001987	23582	437	4676356	19339	664	5208743	15040	455,
		577, 657	4003120	13004	140	4676589	23223	268			510
I53297	16478	42,	4003673L	14967	619,	4696129	18033	472,	5255110	18979	434
		48			647, 662, 665			511	53041045	16873	873,
I560058	19626	864	4004569	10831	457,	4696488	14995	528,			874
I560058	19627	864			509			571, 600, 637, 655	55022134	15042	571
I624705	2744	864	4004569	16259	457,	4717164	18393	619	55055098	18248	473,
I624705	12959	864			511	4717165	18392	619			511
I758099	2752	865	4004689	10330	583						

O.E.M. INTERCHANGE BY MANUFACTURER

OEM No.	Auveco No.	Page No.	OEM No.	Auveco No.	Page No.	OEM No.	Auveco No.	Page No.	OEM No.	Auveco No.	Page No.
55074801	14010	564	6026430	9299	126	6100568	15818	81	6502450	16876	873
	570, 602,	657	6026723	10655	37			87			874
55075139	17214	526	6026723	10656	37	6100810	12115	107	6502491	16870	873
		572, 599	6026723	10657	37	6100811	12253	107			874
55116997-AA	22461	504,	6026958	10086	126	6100815	16829	107	6502573	18032	526,
		521	6027958	19485	72	6100839	12122	110			572, 655
55116997-AB	22461	504,			649, 782	6100840	12123	110	6502625	16835	560,
		521	6029348	16852	126	6101283	11629	117,			572, 601, 656
55156429-AA	20523	653	6029501	12735	583,			152	6502632	16816	529,
55156447-AB	20700	654			649, 851	6101308	18449	116,			572, 603, 656
55156655-AA	21738	655	6030441	11146	457,			151	6502689	18501	341
55156879-AB	20962	651			509	6101455	12160	80,	6502738	17353	129
55157055-AA	20700	654	6030441	15414	457,			85	6502745	16868	873,
55157055-AA	20887	654			510	6101718	19455	86			874
55157065-AA	20887	654	6030441	18815	452,	6102396-AA	19455	86	6502790	14753	540,
55157069-AB	20827	654			512	6104374-AA	22906	81,			571, 601, 638, 656
55157070-AC	20828	653	6030538	10832	457,			87	6502842	17975	466,
55157112-AA	20890	569,			509	6104900-AA	21086	551,			511
		576, 661	6031091	11621	347			576, 659, 776	6502871	14992	534,
55157112-AB	20890	569,	6031115	11620	346	6104908-AA	18302	450,			571, 637, 655
		576, 661	6031147	8865	127			512, 672, 703	6502907	17669	501,
55176248	14020	565,	6031321	10831	457,	6105103-AA	22908	81,			511
		570, 608			509			88	6502988	19519	614,
55177482AA	25253	662	6031383	11704	539,	6105242-AA	22539	116,			663, 666
55256967-AC	19816	434			570			150	6502991	17685	504,
55275388-AB	23944	434	6031390	11699	539,	645350	1256	443			511
55350747-AB	19775	504,			570, 602, 656	6500092	12617	129	6503106	18269	562,
		514	6031438	12995	139	6500284	15329	109			573, 660
5BB14LX9	19245	549,	6031869	12713	585,	6500361	14561	664	6503163	14997	534,
		573, 659			650, 807	6500524	12569	627,			571, 600
5FR56DX9	19894	653	6032061	12566	585,			649	6503204	18862	502,
5FR56XX-AB	19894	653			650	6500526	12715	129			512
5GC7IRC3-AA	20273	575,	6032083	16851	126	6500650	15860	874	6503221	12766	461,
		639, 656	6032138	16687	351	6500651	15861	874			509
5GC7IRK5-AA	20273	575,	6032363	11351	461,	6500653	15861	874	6503339	18249	661
		639, 656			509	6500722	15862	874	6503401	19417	62,
5GF92RC3-AA	20273	575,	6032516	13466	71,	6500724	12569	627,			93, 105, 610, 661
		639, 656			649			649	6503433	18375	317
5GF92RK5-AA	20273	575,	6032856	17615	349	6500787	14016	524,	6503453	18394	566,
		639, 656	6032856	23861	350			570, 603, 657			573, 660
5GUU9K11BA	20993	564,	6032881	12652	359	6500898	13755	341	6503454	18327	539,
		576, 608, 642	6032926	12655	347	6500899	13748	341			573
6000020	2611	141	6032926	14486	347	6500911	13750	342	6503573	15861	874
60000305	24144	435	6033018	23884	458,	6501025	12125	110	6503598	17216	557,
60000558	10073	141			522	6501067	15481	460,			641, 659
60000605	5854	141	6033082	17664	457,			510	6503709	19213	487,
60000705	2619	865			511	6501086	20316	461,			513
60000705	12958	865	6033184	2625	71			514	6503741	11691	583
60000709	2744	864	6033560	15345	127	6501178	14980	110	6503768	18301	455,
60000720	2752	865	6033677	14756	627,	65011868	13747	341			512
60000720	12960	865			649	6501301	16818	455,	6503800	13748	341
60000943	9377	649,	6033688	18810	357			511	6503812	19779	664
		807	6033840	17664	457,	6501415	16980	110	6503819	19417	62,
6001419	5592	474,			511	6501509	18242	341			93, 105, 610, 661
		509	6033854	23850	45	6501544	14021	450,	6503860	17101	342
6002893	10622	437	6033862	11349	505,			510	6503892	18827	465,
6003147	11354	652			509	6501559	13751	342			512
6003201	23637	652	6034212	18461	351	6501590	14019	565,	6503896	17669	501,
6003220	8853	469,	6034213	10375	127			570, 642, 660			511
		509	6034213	24080	127	6501773	12569	627,	6503938	18913	341
6003308	20276	437	6034336	19310	663			649	6503943	20189	459,
6003349	11678	506,	6034376	18373	311	6501773	23885	650			514
		509	6034608	23933	452,	6501825	12259	110	6504014	17669	501,
6003351	11136	473,			522	6501916	15543	458,			511
		509	6034703	18934	45,			510	6504014	18915	501,
6003409	20276	437			60	6501925	18030	539,			512
6003423	11673	461,	6034812	19310	663			572, 658	6504018	19141	317
		509	6034848	19657	349	6501948	19893	454,	6504043	17612	458,
6003486	23721	652	6035094	2562	126			514			511
6003587	11675	453,	6035188	18934	45,	6502078	11146	457,	6504072	19793	650
		509			60			509	6504090	12567	539,
6003737	12563	587	6035201	17639	359	6502078	15414	457,			570, 602, 657
6003752	20276	437	6035201	19263	359			510	6504098	19338	464,
6003774	13927	652	6035274	14037	585,	6502081	16871	873,			513
6003817	23730	652			650			874	6504135	19541	513
6003878	20276	437	6035296	14009	585	6502083	16872	873,	6504424	18375	317
6003916	20276	437	6035401	20179	650			874	6504452	17669	501,
6003965	13927	652	6035414	19406	349	6502085	16873	873,			511
6004036	17151	437,	6035417	18373	311			874	6504521	19422	547,
		652	6035807	19310	663	6502087	16874	873,			573, 658
6004212	14005	341	6036148-AA	18461	351			874	6504555	17222	534,
6006264	3404	128	6036148-AA	20629	352	6502089	16875	873,			572, 603, 640
6010029	19626	864	6036155-AA	11146	457,			874	6504601	19779	664
6010029	19627	864			509	6502089	16876	873,	6504700	13750	342
6010046	2752	865	6036155-AA	15414	457,			874	6504737	23992	342
6010046	12960	865			510	6502090	16877	873,	6505223AA	23982	663
6010093	2744	864	6100042	11629	117,			874	6505292-AA	19386	500,
6010093	12959	864			152	6502091	16878	873,			513
6013029	2619	865	6100047	19216	109			874	6505411-AA	10831	457,
6013029	12958	865	6100048	15329	109	6502104	18771	462,			509
6013122	11677	506,	6100049	15331	109			512	6505417-AA	19836	451,
		509	6100050	15333	109	6502152	16846	116,			514
6023204	15345	127	6100053	15337	109			150	6505425	10831	457,
6025004	15345	127	6100539	12232	80,	6502328	14921	449,			509
6025005	15347	127			83			510	6505534-AA	20829	487,
6025007	15350	127	6100566	12160	80,	6502381	18815	452,			515
6025329	9480	38,			85			512	6505539-AA	18862	502,
		39	6100567	19455	86	6502407	16826	63,			512
6026166	16237	140									

O.E.M. INTERCHANGE BY MANUFACTURER

OEM No.	Auveco No.	Page No.	OEM No.	Auveco No.	Page No.	OEM No.	Auveco No.	Page No.	OEM No.	Auveco No.	Page No.																																																
6505539-AA	19628	502, 513	6510747AA	25155	490, 522	9411943	3401	128	CJ5Z-13N021-A	B9005	291																																																
6505667-AA	20360	459, 515	6510766-AA	22177	536, 579	9422246	13707	42, 47	CSZZ-6503178-B	24145	437																																																
6505686-AA	20362	461, 515	6511238AA	25275	614, 663	9423950	15827	43, 54	CU2Z-14S411-UA	25160	223, 249, 277																																																
6505759-AA	20427	503, 515	6512734AA	22856	554, 580, 659	9427977	13709	44, 55	CV6Z-13N021-A	BH1	292																																																
6505813-AA	18934	45, 60	6512752-AA	21679	455, 518	9428273	13027	43, 54	D0AZ-10756-A	23615	883																																																
6505878-AA	17124	487, 511	68003844-AA	20889	558, 576, 607, 641	972724	4244	430	D0DZ-15A434-B	9883	215, 241, 280																																																
6505918-AA	20515	500, 515	68004187-AA	21187	613	CREATIVE																																																					
6506005-AA	23966	462, 522	68009867-AA	21105	479, 516, 773							CUMMINS																																															
6506007-AA	13751	342	68028049-AA	20377	592													DAYTON																																									
6506008-AA	19639	538, 573, 604, 640, 658	68033045-AA	22209	479, 520																			EUCLID																																			
6506104-AA	20173	664	68033794AA	21442	661																									FIAT																													
6506132-AA	20458	557, 575, 659	68033794-AA	21442	661																															FORD																							
6506161-AA	19278	43, 52, 91, 97	68034329-AA	21442	661																																					DAYTON																	
6506214-AA	19141	317	68039280-AA	21528	654																																											EUCLID											
6506306-AA	20623	661	68053681AA	25324	554, 580, 659																																																	FIAT					
6506654-AA	20274	488, 514	68060366AA	23222	268																																																						
6506655-AA	20275	650	68061648-AA	21329	497, 517	DAYTON																																																					
6506852-AA	20468	650	68063066AA	23222	268							EUCLID																																															
6506852-AB	20468	650	68073375AA	25184	662													FIAT																																									
6506955-AA	22909	663	68073566AA	25188	662																			FORD																																			
6507009AA	25217	628, 651	68084593-AA	21213	615																									DAYTON																													
6507055-AA	20765	502, 515, 666	68085677AA	25194	499, 523																															EUCLID																							
6507669-AA	20766	556, 576, 659	68087885AA	22885	504, 521																																					FIAT																	
6507670-AA	19111	356	68092697-AA	20870	653																																											FORD											
6507686-AA	20765	502, 515, 666	68093042AA	24262	319																																																	DAYTON					
6507741-AA	21354	318	68093998-AA	22432	484, 521, 691, 805																																																						
6508072-AA	21236	649	68122817AA	24262	319	FIAT																																																					
6508197-AA	21098	544, 576, 638	68139270AA	25279	614, 646							FORD																																															
6508365-AA	20623	661	68143484AC	25220	665													DAYTON																																									
6508444-AA	21446	341	68146440AA	22929	653																			EUCLID																																			
6508506AA	22863	663	68172491-AA	21374	593, 654																									FIAT																													
6508540-AA	21418	348	68185909AA	21601	536, 578, 660																															FORD																							
6508643-AA	21348	567, 577, 660	68213168-AA	21791	652																																					DAYTON																	
6508712-AA	20888	546, 576, 605, 658	68225214-AA	21835	652																																											EUCLID											
6508727-AA	21257	459, 517	68241251-AA	22910	492, 522																																																	FIAT					
6508746-AA	14010	564, 570, 602, 657	68250997AC	25325	616																																																						
6508863-AA	20988	544, 576, 605, 658	68257098-AA	21374	593, 654	DAYTON																																																					
6508947-AA	21153	654	68294220AC	25266	620							EUCLID																																															
6509049-AA	20880	545, 576, 605	68353367AA	25439	80, 83													FIAT																																									
6509103-AA	19801	534, 573, 640	68365015-AA	17222	534, 572, 603, 640																			FORD																																			
6509106-AA	21019	664	68395634AA	22836	655																									DAYTON																													
6509135-AA	22543	526, 579	68463254AA	25218	567, 580																															EUCLID																							
6509288-AA	21223	654	68499019AA	25351	480, 538																																					FIAT																	
6509432-AA	22289	616, 644, 663	68499020AA	25349	653																																											FORD											
6509539-AA	21865	44, 56, 92, 100	68526185AA	22836	655																																																	DAYTON					
6509590-AA	21679	455, 518	7368261	16801	195																																																						
6509599-AA	22578	116, 150	812893	12600	267	FIAT																																																					
6509673-AA	21601	536, 578, 660	83501000	12599	267							FORD																																															
6509761-AA	22459	554, 579	83504040	24304	309													DAYTON																																									
6509799-AA	22578	116, 150	83504041	19318	313																			EUCLID																																			
6509884-AA	20989	546, 576, 605, 641	8880417	15672	538, 571, 656																									FIAT																													
6509960-AA	21680	541, 656	8880476	15672	538, 571, 656																															FORD																							
6510123-AA	22535	544, 579	8934-201-262	11855	583, 807																																					DAYTON																	
6510139-AA	22354	545, 579, 658	8934-201-263	9377	649, 807																																											EUCLID											
6510185-AA	22579	116, 151	8934-201-263	9377	649, 807																																																	FIAT					
6510197AA	25265	663	8934201287	16826	63, 67, 80, 84																																																						
6510359AA	25156	490, 522	8934-201-287	16826	63, 67, 80, 84	DAYTON																																																					
6510520AA	20741	355	8934-201-602	12713	585, 650, 807							EUCLID																																															
6510521AA	12118	110	8934-201-621	14007	539, 570, 602, 657													FIAT																																									
6510734-AA	22363	560, 579	8934-201-631	13750	342																			FORD																																			
			8934-201-681	13475	505, 509, 808, 856																									DAYTON																													
			8934-201-767	13966	141, 807																															EUCLID																							
			8934-201-835	17496	341																																					FIAT																	
			8934-202-293	16251	140																																											FORD											
			8934-202-599	17102	488, 511																																																	DAYTON					
			8955-022-134	15042	571																																																						
						FIAT																																																					
												FORD																																															
																		DAYTON																																									
																								EUCLID																																			
																														FIAT																													
																																				FORD																							
																																										DAYTON																	
																																																EUCLID											
																																																						FIAT					
						DAYTON																																																					
												EUCLID																																															
																		FIAT																																									
																								FORD																																			
																														DAYTON																													
																																				EUCLID																							
																																										FIAT																	
																																																FORD											
																																																						DAYTON					
						FIAT																																																					
												FORD																																															
																		DAYTON																																									
																								EUCLID																																			
																														FIAT																													
																																				FORD																							
																																										DAYTON																	
																																																EUCLID											
																																																						FIAT					
						DAYTON																																																					
												EUCLID																																															
																		FIAT																																									
																								FORD																																			
																														DAYTON																													
																																				EUCLID																							
																																										FIAT																	
																																																FORD											
																																																						DAYTON					
						FIAT																																																					
												FORD																																															
																		DAYTON																																									
																								EUCLID																																			
																														FIAT																													
																																				FORD																							
																																										DAYTON																	
																																																EUCLID											
																																																						FIAT					
						DAYTON																																																					
												EUCLID																																															
																		FIAT																																									
																								FORD																																			
																														DAYTON																													
																																				EUCLID																							
																																										FIAT																	
																																																FORD											
																																																						DAYTON					
						FIAT																																																					
												FORD																																															
																		DAYTON																																									
																								EUCLID																																			
																														FIAT																													
																																				FORD																							
																																										DAYTON																	
																																																EUCLID											
																																																						FIAT					
						DAYTON																																																					
												EUCLID																																															
																		FIAT																																									
																								FORD																																			
																														DAYTON																													
																																				EUCLID																							
																																										FIAT																	
																																																FORD											
																																																						DAYTON					
						FIAT																																																					
												FORD																																															
																		DAYTON																																									
																								EUCLID																																			
																														FIAT																													
																																				FORD																							
																																										DAYTON																	
																																																EUCLID											

O.E.M. INTERCHANGE BY MANUFACTURER

OEM No.	Auveco No.	Page No.	OEM No.	Auveco No.	Page No.	OEM No.	Auveco No.	Page No.	OEM No.	Auveco No.	Page No.
E6AZ-5421952-A	15675	647	F4XY-1200586-A	17339	472	N621906-S441	23685	109	N802900-S	13470	487
E6DZ-13466-B	18005	286			511	N621907-S2	15332	109			509
E6DZ-13466-B	B916A	290	F4XY-6734-A	21258	309	N621907-S2	23686	109	N803043-S	13750	342
E6DZ-5421952A	17122	647	F4Z2-6310182-A	20965	635	N621940-S424	15335	109	N803170-S	14021	450
E6DZ-5421952-A	17122	647	F50Y-14603-A	21224	629	N621940-S424	23656	109			510
E6FZ-13466-B	18016	286	F57B-16241-AA	21000	635	N621942-S2	15337	109	N803183-S32	14814	144
E7EB-14421-EA	16342	195	F57E-9C631-AA	15044	566	N621942-S301	15337	109	N803362-S	13993	540
E7EB-14461-BA	20475	194			571, 608	N621942-S441	15337	109		570, 604,	640
E7EB-14474-CA	16344	195	F57Z-16241-AB	20663	635	N623330-S2	18337	116	N803387-S	15668	465
E7EB-14488-NA	23171	266	F57Z-7810182-AAA	19441	635			149			511
E7GZ-17A904-G	16843	569	F58Z-13411-A	23218	246	N623331-S2	18338	116	N803387-S300	15668	465
		572, 768, 801	F58Z-16237A02-A	18848	488			150			511
E7GZ-6120586-B	18692	471			512	N623332-S100	11864	116	N803387-S300	16863	465
		512, 763, 834	F5DZ-13466-B	17996	286			151			511
E7SB-13A093BA	15966	626	F5DZ-13466-B	B3156	290	N623332-S2	11864	116	N803387-S300	16883	109
E7SZ-13032-D	15966	626	F5OY-14603-A	21224	629			151	N803421-S	14019	565
E7ZZ-13466-B	18007	286	F5RZ-14A411-AA	23212	252	N623332-S21	12669	116		570, 642,	660
E804-14526A	15926	211			266			151	N803494-S	14953	568
E804-14526B	15927	211	F5RZ-17698-A	19393	440	N623332-S439	12669	116		571, 598,	636
E804-14526D	15931	211	F5RZ-6730-B	18374	314			151	N803613-S	16863	465
E83Z-16758-A	16832	431	F5TZ-6734-BA	20453	303	N623332-S53	12669	116			511
E83Z-5421952-B	17122	647	F65Z-1521952-AA	19658	620			151	N803678-S	23884	458
E8AZ-13466-A	17996	286	F67Z-7822008-AA	18890	647	N623333-S100	11629	117			522
E8EB-14474-PA	23175	267	F6AZ-14A411-AA	18218	250			152	N803685-S11	14820	617
E8EB-14474-VA	16348	195	F6DZ-16758-AD	16850	431	N623333-S2	11629	117			644
E8FZ-5802354-A	19845	463	F6DZ-5402316-AA	19238	630			152	N803709-S	17103	534
		514	F6DZ-5410182-AA	20358	635	N623340-S2	11625	116		572, 603,	640
E8PZ-13411-D	23028	243	F6HZ-14A464-FUA	23052	264			149	N803716-S	14018	546
E92Z-17C756-C	17060	637	F6TZ-6730-BA	19279	317	N623343-S100	11630	117		570, 641	
		768			536, 574, 601			152	N803734-S	15480	460
E92Z-6120586-A	18271	475	F75Z-14A411-AA	23202	259	N623343-S2	11630	117			510
		512, 763	F75Z-6730-BA	18025	316			152	N803763-S100	20415	618
E97B-13A093-BA	16399	626	F75Z-6730-BA	19773	317	N623344-S2	18339	117			646
E97B-13A093-BB	16399	626	F79Z-1123342-AAA	13030	648			153	N803857-S	20311	451
E9AZ-5422008-A	18891	647	F7CZ-17C756-EA	16843	569	N800296-S439	22700	117			514
E9DB-13N020AA	15940	627			572, 768, 801			151	N803862-S	13751	342
E9DZ-13N129-A	15940	627	F7DZ-5402316-AA	19238	630	N800312-S2	15776	44		17408	346
E9DZ-6730-B	18025	316	F7DZ-7421952-AA	19658	620			59, 92, 103	N803933-S101		348
E9DZ-6730-B	19773	317	F7UZ-1513284-BA	19421	646	N800369	16422	64			565
E9DZ-6734B	18299	302	F7UZ-15238A32	19413	446			66	N803934-S	13994	565
E9FZ-5822008-A	18890	647			636	N800369-S2	16421	64		570, 608,	642
E9SB-6302354ACW	15523	460	F7UZ-15238A32-AAC19413		446			65	N803946-S	14992	534
		510			636	N800387-S	11842	464		71, 637,	655
E9SZ-13N021-A	16898	288	F81Z-13411-AA	23100	244			509	N804189-S	13747	341
E9SZ-13N021-A	B9006	292	F81Z-13411-BA	23129	245	N800394-S2	23811	80	N804193-S100	18167	347
E9SZ-13N021-B	16897	288	F81Z-19D887-AA	20843	251	N800466	15325	109	N804343-S	13748	341
E9TZ-13032B	16399	626	F81Z-6730-AA	20807	313	N800484-S58	16736	19	N804344-S	14967	619
E9TZ-13032-B	16399	626	F81Z-7A010-A	24221	320	N800503-S	11841	629		647, 662,	665
E9TZ-6730-B	19365	321	F81Z-7A010-AA	24285	330	N800744-S	16986	37	N804349S	15479	463
E9TZ-6730-B	24233	311	F85Z-13411-AA	23195	245			106	N804349-S	15479	463
EOVY-13A506-A	17164	643	F8TZ-7A010-AA	24221	320	N800854-S2	18449	116			510
ET7Z-7A01-A	24217	329	F8VZ-54237A02-AA18848		488			151	N804376-S	16421	64
F0CZ-6730-B	24259	316	FL1Z-13N021-A	BH9	292	N800947-S	16893	80			65
F0TZ-14489-J	19004	256	FL3Z-13489-A	22912	632			86	N804376-S307	16421	64
FICZ-13466-C	20595	288	HC3Z-9J305-A	25046	322	N801117-S100	18401	117			65
FICZ-16674-A	18458	478	HU2Z-13B765-A	12237	215			153	N804376-S55	16421	64
		512, 763			241	N801169-S900	22104	43			65
FICZ-16774-A	18458	478	KA80-51PR6	18882	636			52, 91, 97	N804379-S	15478	462
		512, 763			760	N801293-S36	23900	80			510
FICZ-5802316-C	23898	636	KU5Z-14A163-C	25474	648			83	N804448	14757	454
FITZ-13411-B	23215	246	KX6Z-6730-B	24267	313	N801554	15040	455			510
FITZ-13411-E	23214	246	MB455-56143	17632	542			510	N804570-S	14753	540
FITZ-13411-F	23213	246			572, 638, 726, 766	N801603-S2	20271	43		571, 601, 638,	656
FITZ-13411-G	23216	246	MG350-68AB1	18824	491			52, 91, 97	N804570-S	14993	540
FITZ-17698-A	19393	440			512, 764	N801706-S	12569	627		571, 776	
FITZ-7810182-A	19441	635	N605920-S2	12327	81			649	N804583-S	15187	341
FIZZ-13466-A	20286	287			89	N801851-S45	14947	80			353
F22Z-16774-A	14709	453	N606675-S2	23688	80			86, 139	N804583-S	15187	341
		510, 763	N606676-S100	12160	80	N801925	12565	487			353
F2DZ-13466-C	20599	288			85			509	N804614-S	13994	565
F2PZ-14A464-B	23193	255	N606676-S100	15778	80	N801925-S	12565	487		570, 608,	642
F2PZ-14A464-C	19004	256			85			509	N804674-S	15701	564
F2UZ-1602354-AAA	19846	463	N606676-S2	12160	80	N801994	19667	454			571, 642
		514			85			513	N804675-S	17101	342
F32Z-17C756-S	17003	645	N606676-S36	15778	80	N801994 DUP	19667	454	N804759-S	15491	342
		769			85			513	N804765-S	19277	628
F37Z-13411-A	23219	246	N606677-S36	12335	80	N801994-S100	19667	454	N804837-S	14994	565
F3DZ-6730-A	18025	316			86			513		571, 639	
F3DZ-6734-A	18299	302	N606677-S43B	15779	80	N802224-S	20316	461	N804851-S100	19516	359
F3DZ-6734-A	24344	302			86			514	N804992-S58	10654	22
F3LB-14K056-AA	17222	534	N606677-S53B	15779	80	N802239-S	17643	643	N805026S	14995	528
		572, 603, 640			86	N802241-S	17642	644		571, 600, 637,	655
F3LY-14570-B	17222	534	N606689-S2	23817	81	N802331-S53	16842	116	N805026-S	14995	528
		572, 603, 640	N606690-S2	15780	81			151		571, 600, 637,	655
F3PZ-14A464-D	19126	242			88	N802376-S	14754	627	N805083-C	16832	431
F3PZ-14A464-E	19125	242	N606690-S55	15780	81			147	N805155-S	17124	487
F47Z-13411-A	23217	246			88	N802538	14526	147			511
F4CZ-13466-A	16917	286	N606692-S2	16931	81	N802538-S100	14526	147	N805229-S	14988	526
F4CZ-13466-A	B3157	290			88	N802734-S	15480	460			571, 637
F4PZ-14A411-C	19885	254	N610959-S2	13019	45			510	N805231S	15522	536
F4TZ-13N021-B	18662	288			59, 92, 103	N802734-S	19197	461			571, 639
F4TZ-13N021-B	B9007	292	N621900	15325	109			513	N805231-S	15522	536
F4UB-14A464-A	19004	256	N621903	15326	109	N802775-S36	16883	109			571, 639
F4UZ-13B765-A	12237	215	N621905	15328	109						

O.E.M. INTERCHANGE BY MANUFACTURER

OEM No.	Auveco No.	Page No.	OEM No.	Auveco No.	Page No.	OEM No.	Auveco No.	Page No.	OEM No.	Auveco No.	Page No.
N805612-S	17102	488, 511	N811534-S61	19653	43, 91, 98	W704881-S300	19237	44, 56, 631	W708633-S300	21313	464, 517
N805612-S100	17102	488, 511	N811540-S	20360	459, 515	W704897-S417	19419	350	W708713-S900	22876	360
N805660-S	15672	538, 571, 656	N811772-S	19472	610, 643	W704958-S300	19511	534, 573, 643	W708714-S900	22877	360
N805759-S100	16834	350	N905150-S	17466	356	W705002-S300	19338	464, 513	W708717-S900	22878	360
N805889-S100	19480	117, 152	N905180-S	17466	356	W705297-S300	21245	359	W708761-SSB	15480	460, 510
N806113-S	20189	459, 514	NAOI-56145	16858	557, 572, 639, 739, 767, 800	W705376-S900	17420	346	W708761-SSE	19760	460, 514
N806126-S100	17408	346, 348	W17430-S300	22914	630	W705436-S300	19801	534, 573, 640	W708761-SSZUD4	19760	460, 514
N806191-S1901	17643	643	W520802-S439	22584	116, 151	W705532-S300	16726	544, 572, 641	W708771-S300	20530	630
N806289-S	17339	472, 511	W520802-S439	22584	116, 151	W705550-S300	19783	631, 747, 825	W708777-S437	22023	357
N806322-S	18893	539, 573, 637	W520802-S439	22584	116, 151	W705589-S	11146	457, 509	W708777-S900C	21286	358
N806334-S	20245	627	W520813-S439	22699	117, 153	W705589-S	15414	457, 510	W708777-S900C	22023	357
N806340-S	19850	469, 514	W520821-S426	18338	116, 150	W705589-S	19250	457, 513	W708778-S900C	21286	358
N806344-S	18277	463, 512	W520821-S439	18338	116, 150	W705589-S300	11146	457, 509	W708888-SAB	17664	457, 511
N806363-S	20264	630	W520821-S439	18338	116, 150	W705589-S300	15414	457, 510	W708888-SD	17664	457, 511
N806728-S439	25077	116	W520822-S426	12669	116, 151	W705589-S300	15414	457, 509	W708991-S439	22702	116, 149
N806830-S100	17639	359	W520822-S426	12669	116, 151	W705589-SS5YZ	11146	457, 509	W709002-S	20624	455, 515
N806830-S100	19263	359	W520822-S439	22579	116, 151	W705589-SS5YZ	15414	457, 510	W709002-SAA	20624	455, 515
N806903-S	23899	564, 580	W520823-S426	11629	117, 152	W705590-S300	20466	585, 629	W709176-S300	19639	538, 573, 604, 640, 658
N806959-S	19235	423	W520823-S426	11629	117, 152	W705590-S300	20466	585, 629	W709346-S300	17664	457, 511
N807154-S	19373	458, 513	W520823-S439	11629	117, 152	W705681-S300	20360	459, 515	W709346-S300	17664	457, 511
N807154-SZUD4	19373	458, 513	W520823-S439	22700	117, 151	W705711-S417	19414	346	W709371-S300	23966	462, 522
N807168-S	19111	356	W520832-S424	12575	117, 152	W705845-S300	17632	542, 572, 638, 726, 766	W709688-S300	21790	632
N807189-S100	20171	630	W520832-S424	12575	117, 152	W705845-S300	17632	542, 572, 638, 726, 766	W709767-S300	20663	635
N807247-S	19526	631	W520832-S426	12575	117, 152	W705848-S300	14753	540, 571, 601, 638, 656	W709883-S300	13467	466, 509
N807389-S	17216	557, 631	W525157-S300	22540	354	W705848-S300	20355	636	W709984-S300	20631	547, 575, 606
N807455-S100	23888	645	W525170-S417	19414	346	W705894-S300	20245	627	W709995-S300	21247	500, 516
N807535-S	19760	460, 514	W525172-S417	19461	346	W705955-S300	20177	455, 514	W710246-S900	22879	360
N807535-SSZ	19760	460, 514	W525175-S	19456	347	W705955-S300	20177	455, 514	W710250-S300	21089	545, 576, 638
N807577-S	18895	540, 573, 638	W525175-S300	19456	347	W705958-S439	22837	575, 639	W710312-S300	20761	456, 515
N807578-S	18894	539, 573, 638	W623463-S54	8868	127	W706009-S300	16954	644	W710339-S300	23973	350
N807620-S100	18461	351	W700158-S300	23871	631	W706092-S300	21098	544	W710459-S300	20466	585, 629
N807673-S	22058	529, 578, 637	W700566-S300	18383	627	W706172-S309	20401	576, 638	W710528-S300	20817	633
N807721-S	17612	458, 511	W700671-S300	20319	459, 514	W706182-S300	20516	554, 575, 640	W710532-S300	20926	456, 516
N807875-S	19524	508, 513	W701054-S300	18503	566, 573, 642	W706350-S3000	14992	534, 571, 637, 655	W710752-SSC	14992	534, 571, 637, 655
N807943-S	19810	487, 514	W701259-S300	10831	457, 509	W706358-S300	15478	462, 510	W710754-S439	21187	613
N807994-S	18816	631	W701374-S	20399	453, 515	W706436-S300	22723	628	W710763-S901	22104	43, 52, 91, 97
N808041-S437	20742	618	W701374-S300	20399	453, 515	W706436-S300	22723	628	W710791-S437	21215	646
N808048-S	16726	544, 572, 641	W701380-SSW	18379	455, 512	W706494-S300	19849	545, 573, 639	W710825-S300	22924	458, 522
N808147-S	14991	539, 571, 600, 638	W701430-S300	18377	632	W706635-SSW	21241	463, 516	W710923-S300	18680	462, 512
N808182-S309	19436	646	W701649-S	19237	44, 56, 631	W706676-S300	17664	457, 511	W711031-S300	21826	628
N808182-S439	19436	646	W701650-S	19238	630	W706713-S300	20367	545, 575, 638	W711035-S300	17216	557, 572, 606, 641, 659
N808331-S	18895	540, 573, 638	W701855-S300	20366	456, 515	W706737-S300	17121	354	W711035-S300	17216	557, 572, 606, 641, 659
N808332-S	18894	539, 573, 638	W701971	20169	533, 573, 642	W706737-S300	17121	354	W711037-S300	20949	503, 516
N808370-S	19127	459, 513	W701971-S	20169	533, 573, 642	W706738-S300	20190	503, 514	W711079-S300	21368	628
N808679-S	15480	460, 510	W701993-S	17604	423	W706739-S300	20190	503, 514	W711139-S300	8892	338
N808689-S417	19458	347	W702413-S303	22348	44, 57, 92, 102	W706812-S300	19386	500, 513	W711390-S900	22232	80, 87
N808791	20273	575, 639, 656	W702413-S307	22348	44, 57, 92, 102	W706815-S300	21257	459, 517	W711401-S450B	25150	43, 54, 91, 98
N808842-S	19338	464, 513	W702413-S450B	22348	44, 57, 92, 102	W707157-S300	20245	627	W711501-S300	22928	629
N808847-S	19244	564, 573, 642	W702438-S300	22359	631	W707291-S439	20339	116, 149	W711513-S300	21189	504, 516
N808908-S	19337	530, 573, 642	W702438-S300	23870	631	W707501-S300	12253	107	W711521-S300	20616	503, 515
N811006-S	18936	507, 512	W702512-S900C	22023	357	W707504-S900	23973	350	W711612-S300	22701	628
N811018-S100	17639	359	W702554-S900	22066	358	W707593-S300	20190	503, 514	W711687-S300	21199	453, 516
N811018-S100	19263	359	W702554-S900C	22066	358	W707638-S900C	22067	357	W711712-S300	19118	551, 573, 711
N811040-S	20893	450, 516	W702926-S	18744	342	W707889-S300	20192	456, 514	W711858-S300	21334	469, 517
N81169-S	19783	631, 747, 825	W703243-S300	25178	530, 580, 640	W708319-S300	21239	628	W711858-S300	22162	469, 517
N811257-S100	20421	646	W703475-S300	23955	630	W708325-S300	14998	560, 571, 601	W712160-S300	21165	629
N811257-S309	20421	646	W704340-S300	14020	565, 570, 608	W708384-S309	20401	646	W712196-S300	20889	558, 576, 607, 641
N811283-S	20545	544, 575, 638	W704344-S417	19111	356	W708456-S309	16883	109	W712324-S439	22865	116, 150
N811353-S100	20171	630	W704433-SS35B	17216	557, 72, 606, 641, 659	W708464-S450B	22428	80, 85	W712665-S300	20993	564, 576, 608, 642
N811460-S100	19419	350	W704740-S300	18816	631	W708513-S309	20776	646	W712792-S300	22541	478, 521, 672
N811478-S100	20927	72, 628	W704823-S439	21040	116, 149	W708530-S300	20632	559, 575, 607			
			W704874-S439	22537	43, 50, 91, 99	W708621-S300	20190	503, 514			
			W704875-S439	22549	43, 51, 90, 96						

O.E.M. INTERCHANGE BY MANUFACTURER

OEM No.	Auveco No.	Page No.	OEM No.	Auveco No.	Page No.	OEM No.	Auveco No.	Page No.	OEM No.	Auveco No.	Page No.
W712930-S437	8892	338	W718033-S300	22179	482, 520	IJ2Z-14S411-FA	16175	217, 242, 268, 276	380707-S	11370	64, 69
W712990-S300	25217	628, 651	W718037-S300	22354	545, 579, 658	IJ2Z-14S411-FC	16175	217, 242, 268, 276	381671-S	10642	42, 46
W713202-S300	21172	529, 577, 637	W718046-S300	22927	450, 522	IJ2Z-14S411-GA	19125	242	381801-S2	15774	42, 48
W713297-S300	21169	503, 516, 544, 666, 711	W718088-S300	22227	545, 579, 641	IJ2Z-14S411-GB	19125	242	381818-S2	9880	146
W713331-S300	20989	546, 576, 605, 641	W718155-S300	22916	630	IJ2Z-14S411-HA	23122	245	381863-S2	9879	146
W713445-S300	21172	529, 577, 637	W718226-S451	25282	645	IJ2Z-14S411-JA	14918	217, 242, 276	382163-S	19826	144
W713590-S300	21174	634	W718230-S300	21206	496, 516, 707	IJ2Z-14S411-JB	14918	217, 242, 276	382413-S2	17460	43, 50
W713610-S300	20988	544, 576, 605, 658	W718240-S300	21230	635	IJ2Z-14S411-KA	18216	256	382413-S9	17460	43, 50
W713617-S439	25352	644	W718365-S300	22284	564, 579, 642	IJ2Z-14S411-NA	17620	251	382443-S	4439	171, 433
W713651-S300	21247	500, 516	W718369-S300	22475	629	IJ2Z-14S411-NB	17620	251	382461-S9	23713	126
W713727-S300	25089	503, 522	W718456-S300	25090	636	IJ2Z-14S411-TA	20851	250	382570-S	23608	451, 521
W713819-S900	21864	351	W718477-S439	25312	82	IJ2Z-14S411-YA	21490	237, 243, 263, 268, 274	382929-S	12729	613
W714004-S900	22264	356	W718478-S439	25311	82	IU5Z-13466-BB	16901	286	382930-S	14531	297
W714030-S424	25276	615	W718818-S902	25312	82	IW1Z-19E889-HB	17604	423	382931-S	14533	297
W714040-S300	20880	545, 576, 605	W719084-S300	22493	465, 521	IW6Z-238A90-AA	20363	532, 575, 643	383000-S	12929	171
W714076-SS3JA	22180	456, 520	W719209-S300	25354	633	IW6Z-238A91-AA	20363	532, 575, 643	383000-S	12929	171
W714113-S439	25277	645	W719365-S902	25313	82	2C5Z-13N021-AA	BH11	292	383001-S	12930	171
W714171-S439	22844	645	W719367-S300	22349	530, 579, 640	2F1Z-9A317-AA	20482	643	383003-S	12937	171
W714172-S300	25088	628	W719534-S300	25407	617	2F1Z-9A317-BA	20483	643	383004-S	12935	171
W714231-S300	22251	485, 520, 743	W719880-S417	20741	355	2L1Z-7852140-AA	15479	463, 510	383005-S	12931	171
W714241-S300	25348	647	W719957-S300	25350	644	2U2Z-14S411-AA	23206	260	383016	12916	172
W714372-S300	20427	503, 515	W721069-S300	25091	504, 522	2U2Z-13411-AA	23103	244	383031-S100	11863	443
W714584-S300	20766	556, 576, 659	W726675-S439	22913	107	2U2Z-13411-BB	23106	245	383033-S101	11863	443
W714599-S900	17420	346	W790173-S900	21202	633	2U5Z-13411-CA	23104	244	383132-S9	23713	126
W714972-S300	22161	589	W790225-S900	22021	589	2U5Z-13411-DA	22796	243	383142-S	20310	535, 639
W714975-S300	20992	559, 576, 607	W790383-S900	25290	633	2U5Z-13411-HA	23105	244	383207-S	14217	612, 643, 665
W714996-S300	22864	430	W790486-S900	25283	486, 523	2U5Z-13411-RA	23101	244	383229-S	11104	339, 348
W715030-S437	8892	338	XF5Z-14S411-AA	14918	217, 242, 276	2U5Z-13411-SA	23102	244	383229-S	11105	339, 348
W715060-S439	25101	43, 53, 91, 98	XL3Z-13466-AA	BH10	292	2U5Z-13411-WA	25293	247	383229-S	11106	339, 348
W715197-S439	22818	645	XL3Z-13466-AA	BH9	292	309414	16835	560, 572, 601, 656	383255-S36	16770	127
W715201-S300	21668	634	XL3Z-17E971-AA	19607	536, 573, 639	328570-S	23608	451, 521	383356-S	14756	627, 649
W715256-S300	21192	553, 577, 731, 767, 800	XW1Z-5822008-AA	18891	647	351050-S3	2309	443	383847-S	11419	173
W715537-S300	20826	548, 576, 606	XW4Z-54238A70-AA20363		532, 575, 643	351450-S3	2309	443	384051-S	19418	469, 513
W715544-S300	22304	644	XW4Z-6730-BA	24271	315	352839	4258	429	38411S	12949	173
W715801-S439	25278	645	XW7Z-6302354-AAB	20625	462, 515	353123	1256	443	38411-S	12949	173
W715926-S300	21673	454, 518	YF4Z-8194-AA	20400	631	353745-S	2598	167, 435	384432-S	19459	353
W715951-S300	22053	463, 519	YL8Z-16K262-HC	20755	549, 576, 767	354341-S	5196	141	384474-S47X	23799	42, 47
W715980-S439	25279	614, 646	YR3Z-13466-AD	B3157A	290	354860-S	4248	429	384930-S36	23666	38
W716006-S439	25001	643	YS4Z-13N021-AA	18661	288	355891	2611	141	384931-S36	17035	38, 41
W716053-S451	25280	107	YS4Z-16K262-AA	20191	637	355891	2611	141	384932-S36	23665	38
W716156-S303	12255	105	YS4Z-6730-AA	18374	314	357811	4246	429	385189-S100	11620	346
W716165-S439	22840	645	YS4Z-6730-AA	20347	314	358107	2272	443, 665	385323-S100	11621	347
W716350-S300	20977	636	YU5Z-6734-AA	21180	303	358470	9361	443	385330-S	11336	473, 509
W716351-S300	21668	634	YU5Z-13466-AD	16901	286	358560	19626	864	385353-S	12210	171, 433
W716351-S300	22099	634	YU5Z-13466-AD	B3457A	290	358560	19627	864	385400	15345	127
W716352-S300	22124	634	1008068	21853	485, 519, 742, 855	358560	19627	864	385595-S	19655	465, 513
W716460-S300	21187	613	13235-A	8763	241	370247-S2N	5586	146	385661-S	11351	461, 509
W716460-S300	22038	633	16758	4248	429	370374-S	4248	429	385677	19425	468, 513
W716497-S300	21669	634	16758A	4155	430	372741-S100	9864	296	385974-S	19460	356
W716503-S300	22033	634	1725489	21988	852	372820-S36	12654	358	386299-S	19654	644
W716507-S300	22269	493, 520	175720B010	14011	537, 570, 602	372820-S40	12654	358	386553-S	19655	465, 513
W716510-S300	21703	542, 578, 638	IF1Z-14A411-BA	23201	246, 259, 266	373528-S32	5854	141	387042-S	12939	173
W716529-S900	22289	644, 663	IF1Z-14A411-CA	20561	263	373846-S	12918	172	387065-S	12932	173
W716569-S300	25189	632	IF1Z-19E889-AA	19235	423	375203-S	17467	349	387074-S	12933	173
W716783-S300	22431	632	1L24-17A386-AA	16421	64, 65	375372-S	5592	474, 509	387182-S	11671	488, 509
W716878-S300	25289	635	IJ2Z-14S411-AAA	17624	261	375480-S100	5195	141	387258-S	11679	453, 509
W716909-S439	25281	645	IJ2Z-14S411-AAB	17624	261	375480-S102	5195	141	387466-S	12209	171, 433
W716969-S300	21703	542, 578, 638	IJ2Z-14S411-AEA	20843	251	375890-S100	2595	141	387477-S	11797	490, 509
W717086-S439	22491	617	IJ2Z-14S411-AFA	23204	260	375936-S	17469	348	387496-S	11672	506, 509
W717182-S900	22880	360	IJ2Z-14S411-AJA	18671	251	376337-S100	9853	36	387843-S	11705	533, 570, 639
W717184-S900	22881	360	IJ2Z-14S411-AJA	23208	252	376337-S100	9855	36	387944-S	11706	548, 570
W717185-S900	22882	360	IJ2Z-14S411-APA	20246	262	376785-S2	15351	127	387980-S	12948	173
W717186-S900	22883	360	IJ2Z-14S411-ARA	20550	263	376988-S2	10654	22	388020-S47	24178	42
W717337-S900	22884	360	IJ2Z-14S411-BA	20277	262	377537-S	16039	24	388034	12919	172
W717736-S300	22154	741	IJ2Z-14S411-BB	20277	262	378527-S100	17470	349	388047-S100	11852	346
W717793-S439	22915	81, 88	IJ2Z-14S411-BCA	16175	217, 242, 268, 276	379046-S	8427	63, 69	388047-S102	12653	347
W717823-S300	22532	563, 579	IJ2Z-14S411-BDA	23200	245	379830-S	9862	627	388047-S1021	11852	346
W717870-S300	18030	539, 572, 658	IJ2Z-14S411-BDB	23200	245	379830-S	14756	627, 649	388047-S1021	12653	347
W717918-SS34X	25182	522	IJ2Z-14S411-BEA	23128	245	379831-S	8814	148	388131-S	12925	172
W717970-S300	22474	629	IJ2Z-14S411-BEB	23128	245	379831-S	10052	148			
W719844-S417	22333	353	IJ2Z-14S411-BEC	23128	245	380098-S2	8306	339			
			IJ2Z-14S411-BXA	20842	248	380111-S	12949	173			
			IJ2Z-14S411-CX	19582	251	380334-S	8310	339			
			IJ2Z-14S411-DA	19126	242	380575-S2	8847	38, 41			
			IJ2Z-14S411-EA	23121	245	380613-S	4439	171, 433			
						380614-S	4440	171, 433			
						380615-S	12209	171, 433			
						380707-S	11368	72			

O.E.M. INTERCHANGE BY MANUFACTURER

OEM No.	Auveco No.	Page No.	OEM No.	Auveco No.	Page No.	OEM No.	Auveco No.	Page No.	OEM No.	Auveco No.	Page No.
388246-S	11612	451, 509	3U2Z-14S411-EKA	23055	243, 258	3U2Z-14S411-VZB	16694	217, 242, 276	6U2Z-14S411-TA	23076	264
388248-S-36B	11768	144	3U2Z-14S411-EMMA	23016	234, 257	3U2Z-14S411-XA	19813	262	6W1Z-5422008-A	18890	647
388442-S100	12652	359	3U2Z-14S411-EPAB	23437	230, 255	3U2Z-14S411-XBA	18216	256	7U2Z-14S411-AA	23062	248
388442-S309	12652	359	3U2Z-14S411-ESA	20549	251	3U2Z-14S411-XLA	20839	253	7U2Z-14S411-FA	17621	254
388499-S	23683	490, 521	3U2Z-14S411-ESAA	20851	250	3U2Z-14S411-XXA	20841	253	800843	12935	171
388577-S	11146	457, 509	3U2Z-14S411-ESB	20549	251	3U2Z-14S411-YHA	18673	261	801471	12922	172
388664-S100	14127	355	3U2Z-14S411-EUA	16174	217, 242, 267, 276	3U2Z-14S411-YNA	18673	261	803716-S	14018	546, 570, 641
388904-S	20316	461, 514	3U2Z-14S411-EUB	16174	217, 242, 267, 276	3U2Z-14S411-ZA	19887	262	93BZ-13466-A	BH7	292
388908-S	14163	465, 510	3U2Z-14S411-EYAA	23204	260	3U2Z-14S411-ZVA	23186	255	9N7Z-13N021-A	16897	288
388908-S	19655	465, 513	3U2Z-14S411-FFAA	18216	256	3U2Z-14S4AA-SLA	20845	257	9N7Z-13N021-A	16898	288
388916-S	12908	171, 433	3U2Z-14S411-FGAA	23202	259	3U2Z-13N021-BA	BH7	292	9N7Z-13N021-A	B9005	291
388930-S	12909	463, 509	3U2Z-14S411-FHAA	23059	244	3W7Z-5422008-AA	18890	647	9T4Z-13466-A	B3157	290
389129-S	12907	171, 433	3U2Z-14S411-FUA	23033	257	45262	10048	148	10003294	12919	172
389138	12937	171	3U2Z-14S411-FVA	19880	257	45262-S2	10048	148	10003617	12927	172
389144-S	17075	490, 511	3U2Z-14S411-FZA	25192	260, 279	45263-S101	10050	148	10004121	12943	173
389258	10831	457, 509	3U2Z-14S411-GA	18819	261	45263-S2	10050	148	10008002	8814	148
389268-S100	11621	347	3U2Z-14S411-GAA	23076	264	45264	10053	148	10009923	12259	110
389358-S	10831	457, 509	3U2Z-14S411-GEA	18870	233, 253, 256	45264-S2	12265	148	10013764	11352	613
389358-S	16259	457, 511	3U2Z-14S411-GJA	23024	254	45265-S2	10054	149	10014363	12997	139
389443-S	12571	461, 509	3U2Z-14S411-HNA	17623	253	45265-S2	10051	148	10017487	12931	171
3895904	12923	171	3U2Z-14S411-HVA	23269	249, 255, 260, 270, 272, 273	45268-S2	8814	148	10017615	14677	315
390018-S	17664	457, 511	3U2Z-14S411-HYA	23271	260, 273	45268-S2	10052	148	10018202	12695	129
390126-S	14017	452, 510	3U2Z-14S411-HYB	23271	260, 273	45269	10055	149	10027015	17230	584
390126-S	14857	452, 510	3U2Z-14S411-HZA	20848	242	45269-S	10055	149	10031004	18014	286
390428-S100	17410	346, 354	3U2Z-14S411-HZB	20848	242	45332	15347	127	10032838	12713	585, 650, 807
390523-S	15675	647	3U2Z-14S411-JDA	23028	243	45334	15345	127	10036503	14023	341
390964-S	18682	452, 512	3U2Z-14S411-JKA	20837	242	4F1Z-9A317-AA	2124	644	10040001	9282	328
391304-S100	17606	423	3U2Z-14S411-JLA	23064	244, 254, 259, 264	4F9Z-13411-A	25296	247	10041588	14527	147
391305-S100	17607	423	3U2Z-14S411-KA	23052	264	4L3Z-1510182-AA	20862	632	10051034	15467	439
391349-SS	23937	522	3U2Z-14S411-KBA	20846	260	4U2Z-14S411-DA	20852	261	10053182	14997	534, 571, 600
391396-S100	17604	423	3U2Z-14S411-KGA	19885	254	4U2Z-14S411-RA	23055	243, 258	10053388	15045	566, 571, 608
391397-S100	17605	423	3U2Z-14S411-KRA	17623	253	55914-S2	13021	45, 59	10062	12253	107
3M7Z-13466-A	B7440	290	3U2Z-14S411-KRB	17623	253	56910-S2	13025	42, 48	10062367	16695	491, 511
3M8Z-1502316-A	20923	568, 576, 637, 765	3U2Z-14S411-KTA	17624	261	56910-S424	13025	42, 48	10063599	18683	449, 512
3M8Z-16K262-A	21304	630	3U2Z-14S411-LJA	23051	252, 264	56911-S2	13711	42, 49	10073833	12992	507, 509
3M8Z-17C432-A	21300	629	3U2Z-14S411-LKA	23071	229, 254, 272, 278	56911-S36	13711	42, 49	10077283	15042	571
3U2Z-14S411-ACA	23039	258	3U2Z-14S411-LNA	19623	253	56911-S61	13711	42, 49	10084751	19644	153
3U2Z-14S411-AVAA	18867	226, 253	3U2Z-14S411-LVA	17683	256	56912-S	13026	42, 43, 50	10089262	14987	526, 571, 599, 655
3U2Z-14S411-BFA	17684	261	3U2Z-14S411-MGA	17598	251	56929-S2	13711	42, 49	10098645	18682	452, 512
3U2Z-14S411-BGA	18215	256	3U2Z-14S411-MGA	23168	252, 265	57030-S2	10823	38, 39	10108746	16625	557, 571, 606
3U2Z-14S411-BGB	18215	256	3U2Z-14S411-MHA	23057	264	57030-S36	17034	38, 39	10109689	15490	342
3U2Z-14S411-BHA	11439	215, 241, 281	3U2Z-14S411-MVA	20547	262	57032-S36	24168	38	10120517	23833	42, 90
3U2Z-14S411-BHB	11439	215, 241, 281	3U2Z-14S411-MYA	20548	262	57039-S2	9756	38, 40	10121502	11130	465, 509
3U2Z-14S411-BHC	11439	215, 241, 281	3U2Z-14S411-NCA	18668	248	57041-S2	23662	38	10121502	11146	457, 509
3U2Z-14S411-BHX	17684	261	3U2Z-14S411-NJA	23182	266	57041-S36	23663	38	10121502	15414	457, 510
3U2Z-14S411-BXA	18867	226, 253	3U2Z-14S411-NKA	23182	266	57048-S2	23664	38	10125439	16864	353
3U2Z-14S411-BXB	17684	261	3U2Z-14S411-NLA	23040	258	57472-S2	24177	38	10126901	15669	506, 511
3U2Z-14S411-BXB	18867	226, 253	3U2Z-14S411-NRA	13644	237, 261	5C3Z-12224-A	18527	232, 256	10131511	18461	351
3U2Z-14S411-BXB	23169	265	3U2Z-14S411-NUA	23180	265	5C3Z-12224-A	23034	234, 257	10134407	18030	539, 572, 658
3U2Z-14S411-BYA	19126	242	3U2Z-14S411-NZA	19882	237, 257, 262	5C3Z-13466-AA	18016	286	10139822	14991	539, 571, 600, 638
3U2Z-14S411-CDA	23269	249, 255, 260, 270, 272, 273	3U2Z-14S411-NZA	23181	222, 235, 240, 248, 259, 266	5C3Z-13N021-AA	18465	286	10140480	16835	560, 572, 601, 656
3U2Z-14S411-CEAA	23202	259	3U2Z-14S411-NZA	23181	222, 235, 240, 248, 259, 266	5C3Z-14S411-AA	BH13	292	10143422	17102	488, 511
3U2Z-14S411-CEAB	23202	259	3U2Z-14S411-PCA	18463	261	5F7Z-13466-B	20285	287	10146315	20177	455, 514
3U2Z-14S411-CFA	17661	253	3U2Z-14S411-PGA	23212	252, 266	5L8Z-16828-AA	16954	644	10153057	16695	491, 511
3U2Z-14S411-CJAA	17110	232, 254, 256	3U2Z-14S411-PJA	18463	261	5N2Z-13466-A	B7440A	290	10155743	23833	42, 90
3U2Z-14S411-CJAA	23156	220, 222, 225, 229, 235, 239, 245, 248, 252, 254	3U2Z-14S411-RPA	23201	246, 259, 266	5R3Z-54310D12-AAA	21024	541, 576, 641, 766	10157900	16622	546, 571, 605
3U2Z-14S411-CKAA	23061	244	3U2Z-14S411-SCA	17112	226, 253	5R3Z-54310D12-BAA	21560	454, 518, 763	10158124	18175	488, 511
3U2Z-14S411-CNA	20561	263	3U2Z-14S411-SCA	23020	230, 242, 257, 263, 269	5T2Z-13411-A	25292	247	10160960	18935	356
3U2Z-14S411-CNB	20561	263	3U2Z-14S411-SCA	23020	230, 242, 257, 263, 269	5U2Z-14S411-DA	23024	254	1016937	12669	116, 151
3U2Z-14S411-CVAA	17623	253	3U2Z-14S411-SFA	19882	237, 257, 262	5U2Z-14S411-DB	23024	254	10169777	20344	450, 515
3U2Z-14S411-DNAA	23058	243	3U2Z-14S411-SLA	20845	257	5U2Z-14S411-SA	19156	250, 251	10169998	23833	42, 90
3U2Z-14S411-DTA	23048	264	3U2Z-14S411-SMA	20845	257	5U2Z-14S411-SB	19156	250, 251	10182300	23884	458, 522
3U2Z-14S411-ECA	23122	245	3U2Z-14S411-SMB	20845	257	5U2Z-14S411-TA	19156	250, 251	10184895	13751	342
3U2Z-14S411-ECAA	21490	218, 237, 243, 263, 268, 274	3U2Z-14S411-TAA	23186	255	5U2Z-14S411-VA	19582	261	10185925	18301	455, 512
3U2Z-14S411-EDAA	20246	262	3U2Z-14S411-UEA	17622	255	5U2Z-14S411-VB	20842	248	10195515	14995	528, 571, 600, 637, 655
3U2Z-14S411-EEAA	16693	232, 256	3U2Z-14S411-UNA	23046	219, 225, 229, 234, 239, 243, 252, 254, 263	5U2Z-14S411-ZB	23199	249	10201332	19514	353
			3U2Z-14S411-VA	23271	260, 273	6000121	13173	850, 862	10204266	18170	359
			3U2Z-14S411-VBA	19157	256	6E5Z-13466-AC	B4157K	290			
			3U2Z-14S411-VBB	19157	256	6E5Z-7850980-AAA	21024	541, 576, 641, 766			
			3U2Z-14S411-VFA	23252	240	6G1Z-5410182-A	20977	636			
			3U2Z-14S411-VNA	23193	255	6G1Z-5410182-C	20979	633			
			3U2Z-14S411-VZA	16694	217, 242, 276	6U2Z-14S411-AA	23061	244			
						6U2Z-14S411-AB	23061	244			
						6U2Z-14S411-CA	23058	243			

O.E.M. INTERCHANGE BY MANUFACTURER

OEM No.	Auveco No.	Page No.	OEM No.	Auveco No.	Page No.	OEM No.	Auveco No.	Page No.	OEM No.	Auveco No.	Page No.
10207146	17226	535, 604	10445899	21504	594	11502941	12693	80, 84	11504693	11626	116, 150
10211824	10831	457, 509	10476561	9282	328	11503317	11630	117, 152	11504978	12666	116, 152
10212112	18749	355	106653	12543	213	11503394	12740	42, 49, 90, 95	11504981	12068	45, 61, 93, 104
10212112	18749	355	11056321	24281	330	11503395	12741	42, 50, 90, 95	11504982	12343	81, 89
10220168	18688	462, 512	11500086	12350	45, 105	11503396	12742	43, 51, 90, 96	11505005	12596	109, 45
10229437	18680	462, 512	11500401	15335	109	11503412	24173	93	11505022	12351	60, 93, 104
10237960	19220	618	11500421	2775	22	11503421	12213	22, 42, 48	11505023	12339	45, 60, 93, 104
10241518	18688	462, 512	11500434	15373	43, 51, 91, 97	11503432	12117	107	11505044	18416	81, 87
10242285	20521	594	11500654	18337	116, 149	11503455	12667	117, 152	11505104	13712	42, 49, 90, 95
10242316	18680	462, 512	11500655	11625	116, 149	11503483	12742	43, 51, 90, 96	11505209	13618	81, 87
10246149	19788	526, 600	11500656	18338	116, 150	11503499	23841	42, 43, 90	11505326	15790	81, 88
10262036	18684	449, 512	11500657	11626	116, 150	11503503	12097	43, 51, 90, 96	11505329	12595	109, 862
10278936	17654	343	11500658	11628	117, 152	11503578	18261	42, 50, 90, 95, 96	11505329	23684	109
10280874	18680	462, 512	11500660	11629	117, 152	11503619	13613	81, 88	11505596	18338	116, 150
10280874	18688	462, 512	11500661	11630	117, 152	11503632	12336	81, 88	11505816	23801	80
10281487	20395	618	11500662	11631	117, 153	11503636	12213	22, 42, 48	11506117	15335	109
10283414	19368	470, 513	11500663	18339	117, 153	11503668	13705	81, 89	11506174	12693	80, 84
10285935	19270	490, 513	11500754	11935	81, 87	11503695	15335	109	11508023	12322	80, 84
10285935	20338	491, 515	11500754	23661	81	11503698	12124	110	11508241	12575	117, 152
10287379	20261	81, 87	1150086	12350	45, 62, 93, 105	11503714	11864	116, 151	11508269	13614	81, 88
10287547	20408	589	11500970	12336	81, 88	11503715	12575	116, 151	11508275	15330	109
10287926	20232	437, 588	11500971	12348	81, 88	11503716	11864	116, 151	11508430	12339	45, 60, 93, 104
10287971	19275	490, 513	11500994	12057	44, 59, 92, 103	11503719	18449	116, 151	11508827	23809	42, 90
10293193	20893	450, 516	11500996	12339	45, 60, 93, 104	11503736	14980	110	11508900	12253	107
10293674	19149	451, 513	11500997	12354	45, 61, 93, 104	11503752	12595	109, 862	11508927	13002	140
10297369	20521	594	11501102	13613	81, 88	11503754	12596	109	11508930	15791	80, 84
10297370	20825	594	11501105	11633	81, 87	11503756	12596	109	11509005	18449	116, 151
10297371	19379	594	11501152	13613	81, 88	11503785	18261	42, 50, 90, 95, 96	11509189	12350	45, 62, 93, 105
10298115	19486	582	11501188	13614	81, 88	11503800	12324	84	11509371	12057	44, 59, 92, 103
10299660	19449	469, 513	11501193	11641	81, 89	11503812	12064	80, 84	11509374	12741	42, 50, 90, 95
10300287	20353	594	11501194	13620	89	11503815	12322	80, 84	11509511	11639	81, 88
10301966	20365	543, 605	11501794	12739	42, 47, 90, 95	11503823	12693	80, 84	11509535	15711	107
10305191	20814	491, 515	11501800	15334	109	11503825	13618	81, 87	11509589	11638	81, 87
10308019	20521	594	11501835	12253	107	11503833	15788	80, 86	11509816	12067	80, 84
10323057	20607	592	11501836	12255	107	11503834	12065	80, 86	11509932	12253	107
10350983	21346	488, 517	11501849	12260	110	11503834	12065	80, 86	11510062	12253	107
10351052	21347	584	11501883	12059	42, 46, 48, 90, 94	11503892	15373	43, 51, 91, 97	11513599	20339	116, 149
10351666	BH9	292	11501884	12060	43, 51, 90, 96	11503941	13617	80, 85	11513798	20600	288
10352798	20973	591	11501896	12061	42, 46, 49, 90, 94, 95	11503957	11864	116, 151	11513798	BH3	292
10352799	19757	591	11501903	12062	42, 47, 90, 94	11503957	12669	116, 151	11513801	12738	43, 51, 90, 96
10352799	19757	591	11501932	12253	107	11503982	12066	80, 86	11513864	12064	80, 84
10352799	20808	591	11501937	12119	110	11504047	16842	116, 151	11514282	15711	107
10352803	19800	591	11502449	15373	43, 51, 91, 97	11504056	12738	43, 51, 90, 96	11514290	10067	147
10352809	20775	591	11502483	12097	43, 51, 90, 96	11504119	16980	110	11514343	11639	81, 88
10352809	20775	591	11502504	12125	110	11504230	1943	21	11514623	12067	80, 84
10352810	19800	591	11502507	15711	107	11504288	12667	117, 152	11515478	12575	117, 152
10352810	19800	591	11502540	12115	107	11504303	23689	80, 86	11515638	22074	116, 149
10363352	21177	596	11502605	11639	81, 88	11504492	12348	81, 88	11515756	11639	81, 88
10363811	20634	489, 515	11502607	23711	81	11504493	12323	80, 86	11515757	13614	81, 88
10369649	21240	493, 516	11502617	11629	117, 152	11504531	9879	146	11516077	11708	108
10382313	21176	563, 577	11502618	22164	80, 83	11504536	13002	140	11516148	18477	287
10383817	21157	597	11502618	22164	80, 83	11504565	13619	81, 89	11516149	12667	117, 152
10384814	20950	596	11502624	11639	81, 88	11504567	13614	81, 88	11516150	11630	117, 152
10403591	19449	469, 513	11502630	23794	42, 90	11504570	12067	80, 84	11516150	12667	117, 152
10405030	19368	470, 513	11502737	12127	110	11504614	15327	109	11516152	18339	117, 152
10408480	19527	490, 513	11502759	12126	110	11504654	23698	91	11516372	20416	116, 152
10410398	19220	618	11502790	11935	81, 87	11504659	2709	19			
10416890	19757	591	11502794	12118	110						
10421018	20338	491, 515	11502811	11709	108						
10423331	19783	631, 825	11502812	11708	108						
10423332	19783	631, 825									
10423553	20481	594									
10425306	20365	543, 605									
10426887	20775	591									
10431503	20775	591									
10431524	19757	591									
10431761	19821	596									
10437563	19800	591									
10437565	19800	591									
10442914	20353	594									
10443956	20328	592									

O.E.M. INTERCHANGE BY MANUFACTURER

OEM No.	Auveco No.	Page No.	OEM No.	Auveco No.	Page No.	OEM No.	Auveco No.	Page No.	OEM No.	Auveco No.	Page No.
11516397	20339	116, 149	11547577	22240	482, 520	11570951	23985	63, 65	11609952	21027	616
11516440	3079	21	11547581	22492	593	11571016	25274	615	11609952	21754	616
11516596	13705	81, 89	11547582	22491	617	11571063	25343	508, 523	11609989	12065	80, 86
11516656	20935	594	11547601	22278	485, 520	11571109	23993	557	11610086	15543	458, 510
11516780	15335	109	11547602	22279	485, 520	11571118	21535	489, 518	11610086	15543	458, 510
11516780	23656	109	11547637	22953	610	11571119	21536	489, 518	11610157	21524	616
11516807	20741	355	11548298	22579	116, 151	11571159	21443	464, 517	11610198	20529	586
11516811	13755	341	11548579	22582	149	11571175	20934	593	11610210	21114	349
11516936	18927	354	11548580	22583	116, 149	11571175	21242	593	11610245	17427	346
11516942	13619	81, 89	11548585	22838	117, 152	11571175	21374	593, 654	11610271	3079	21
11517071	11708	108	11548586	22699	117, 153	11571225	22911	584	11610383	21124	357
11517079	22579	116, 151	11548673	22886	616	11588308	18461	351	11610495	21793	593
11517293	12596	109	11548932	25271	589	11588308	21327	341	11610522	21157	597
11517343	12065	80, 86	11549307	22839	486	11588415	18337	116, 149	11610544	22410	617
11517517	12324	80, 84	11561143	12127	110	11588451	21351	619	11610605	21488	482, 517
11517700	19449	469, 513	11561329	21200	595	11588650	20883	615	11610606	21489	485, 517
11517706	13619	81, 89	11561334	22266	357	11588863	20944	488, 516	11610700	25180	590
11517769	23461	617	11561349	20766	556, 576, 659	11588988	20631	547, 575, 606	11610705	20938	584
11517803	16622	546, 571, 605	11561353	14998	560, 571, 601	11589012	22724	43, 91, 98	11610747	21301	460, 517
11517841	25077	116	11561368	20888	546, 576, 605, 658	11589015	12738	43, 51, 90, 96	11610748	21302	611
11517873	20452	585	11561448	18153	616	11589031	22536	80, 85	11611110	21672	545, 578, 605
11517996	11708	108	11561448	24179	616	11589111	21439	354	11611321	22581	116, 151
11518017	20632	559, 575, 607	11561491	20884	596	11589176	20972	592	11611342	22533	470
11518201	20281	461, 514	11561499	21383	489, 517	11589181	21199	453, 516	11611367	22268	591
11518357	20328	592	11561500	21384	586	11589244	20891	597	11611375	21825	590
11518357	20377	592	11561509	20261	81, 87	11589289	20988	544, 576, 605, 658	11611435	21827	596
11518377	24265	315	11561654	21333	502, 517	11589290	13996	540, 570, 604	11611626	21739	597
11518531	21027	616	11561655	20938	584	11589290	14007	539, 570, 602, 657	11611651	22173	351
11518684	20415	618, 646	11561740	19644	153	11589290	14753	540, 571, 601, 638, 656	11611664	25050	470, 522
11518908	20395	618	11561838	12253	107	11589291	20989	546, 576, 605, 641	11611677	22233	465
11518937	22117	617	11561874	21361	564, 577, 609, 801	11589292	20991	557, 576, 607	11611822	21488	482, 517
11518988	21036	595	11561987	21518	586	11589292	14007	539, 570, 602, 657	11611838	22277	617
11519023	21286	358	11562026	23888	645	11589292	14753	540, 571, 601, 638, 656	11611882	22945	50
11519030	21189	504, 516	11562043	20995	489, 516	11589292	20880	545, 576, 605	11612034	25221	611
11519031	20616	503, 515	11562044	20996	489, 516	11589291	20989	546, 576, 605, 641	11612035	20991	557, 576, 607
11519031	21379	503, 517	11562250	21242	593	11589292	20991	557, 576, 607	11612122	22036	593
11519032	21189	504, 516	11562256	20998	489, 516	11589293	20889	558, 576, 607, 641	11612177	12125	110
11519069	25183	614	11562257	20999	489, 516	11589294	20992	559, 576, 607	1165051	19626	864
11519408	21047	314	11562287	20634	489, 515	11589295	20993	564, 576, 608, 642	1165051	19627	864
11519444	20359	547, 575, 605	11562288	23553	489, 522	11589296	20994	564, 576	117971	4417	424
11519444	20631	575, 606	11562364	21187	613	11589329	25275	614, 663	119005	16897	288
11519807	18896	560, 573, 607	11562503	21753	616	11601845	25181	595	1196781	3682	71
11519818	19783	631, 747, 825	11562563	21128	592	11602471	25276	615	12001470	13549	216
11519949	19239	552, 580, 606, 675, 711, 756, 785, 844	11562568	22034	504, 519	11602522	22994	480, 521	12003757	13545	216
11519952	20422	618	11562588	21047	314	11603057	25416	615	12003759	12600	216, 267
11519960	20423	618	11562588	21047	314	11603260	25085	480, 522	12003878	13544	216
11546343	22451	352	11569618	20423	618	11603262	25247	490, 523	12004005	12536	213
11546449	22947	109	11569697	21161	596	11603263	25248	490, 523	12004009	12540	213
11546459	15335	109	11569700	22031	503, 519	11603264	25249	492, 523	12004010	16359	213
11546588	22240	482, 520	11569768	11146	457, 509	11609292	22035	618	12004188	19199	205
11546635	22036	593	11569810	25272	502	11609317	20422	618	12004201	8775	190
11546805	22071	479, 519	11569917	20423	618	11609385	12575	117, 152	12004311	12237	215, 241
11546850	22267	499, 520	11569917	22121	618	11609411	12596	109	12010085	15948	189
11546850	22267	499, 520	11569918	21129	594	11609411	23685	109	12010182	15937	189
11546868	22874	629	11569920	21158	590	11609417	20826	548, 576, 606	12010293	18326	190
11546963	22278	485, 520	11569921	22803	597	11609483	21377	610	12010300	15955	190
11546964	22279	485, 520	11569971	25045	117, 153	11609535	20527	586	12010717	15953	188
11547024	22276	591	11569973	20891	597	11609536	20529	586	12010974	18146	188
11547026	22167	591	11570015	22538	617	11609624	19220	618	12010975	18152	189
11547047	22259	487, 520	11570082	13614	81, 88	11609651	21745	615, 646, 663, 740, 816	12010996	15949	188
11547077	25271	589	11570498	22946	43, 52	11609738	14980	110	12012000	14884	197
11547155	25190	614	11570498	22946	43, 52	11609740	21667	595	12013813	13543	216
11547210	22029	594	11570612	25273	615	11609762	22081	43, 53, 91, 97	12014012	14462	189
11547211	22258	593	11570637	22070	43, 52, 91, 97	11609836	22121	618	12014254	20751	198
11547339	22228	587	11570654	22289	616, 644, 663	11609862	20938	584	12014836	14153	190
11547341	21835	652	11570768	25007	46, 94	11609923	21667	595	12014837	14154	190
11547341	22846	589	11570830	21674	585	11609952	23985	63, 65	12015024	18148	188
11547420	22946	43, 52	11570846	21370	595	11609952	21667	595	12015151	12546	213
11547446	22277	617	11570847	22027	594	11609952	21667	595	12015193	20618	190
11547523	22542	596							12015323	14152	190
11547574	21488	482, 517							12015631	19795	293, 611

O.E.M. INTERCHANGE BY MANUFACTURER

OEM No.	Auveco No.	Page No.	OEM No.	Auveco No.	Page No.	OEM No.	Auveco No.	Page No.	OEM No.	Auveco No.	Page No.
12015878	17002	192	12089191	19262	182	12124580	15937	189	12531210	19441	635
12015899	20749	190	12089305	15948	189	12124581	18324	189	12533567	17103	534
12015917	18324	189	12089306	18325	189	12124582	15948	189		572, 603, 640	
12020116	14880	192	12089307	20747	189	12124587	18325	189	1254815	11338	533
12020120	15939	194	12089340	16806	191	12125637	11440	231	1257702	14217	612
12020126	15944	194	12089649	14883	190			272		643, 665	
12020320	11948	191	12092075	16360	213	12125641	25211	230	12580254	24356	303
12020321	18650	191	12092080	16355	213	12125649	22770	233	1264963	12713	585
12020347	15935	191	12092081	16354	213			237		650, 807	
12020757	14883	190	12092344	20226	193	12126012	23187	285	12713651	24295	312
12020801	20748	189	12092345	20227	193	12126032	22771	231	127934	16910	286
12027133	18923	218	12094429	20583	197			255, 272	1304225	4249	430
12029960	17463	221	12101855	18870	233	12126451	18674	232	131282	16914	286
12033674	14150	189			253, 256	12126452	15952	188	13144822	21541	44
12033817	15960	191	12101856	18320	221	12126453	22772	218		58, 92, 103	
12034046	15947	193	12101858	23221	223			228, 238	13252118	21365	482
12034047	15946	192	12101869	18151	188	12126458	22932	228		517	
12034051	14151	189	12101871	23259	231			233	13252119	21364	485
12034342	18149	188	12101879	13559	216	12126469	23016	234		517	
12040902	15924	190			241, 267			257	13265959	22168	466
12040983	19851	298, 612	12101880	18867	226, 253	12126470	16967	220		520	
								227, 284	13435002	25421	590
12040984	19440	298, 611	12101881	23210	231	12126473	18527	232	13475541	22576	459
			12101888	23265	230			256		515	
12041351	20618	190	12101895	17109	223	12126487	17112	226	13500802	16694	217
12043215	16694	217, 242, 276	12101896	23079	226			253		242, 276	
			12101897	16174	217	12126543	23009	238	13503359	B194	290
12045234	15927	211			242, 267, 276	12129373	20213	191	13503360	B921	290
12045236	15926	211	12101898	16175	217	12129409	20223	193	13503401	16902	286
12045773	18653	191			242, 268, 276	12129484	20212	191	13503401	20285	287
12046623	23016	234, 257	12101899	23016	234	12129493	18658	192	13503418	BH13	292
					257	12129497	18659	192	1351769	9112	165
12046624	16693	232, 256	12101903	17690	237	12141301	23130	220	1355003	9069	584
			12101906	16967	220	12141302	23131	220	13579188	22887	287
12047581	15498	191			227, 284	12141388	23127	219	13579188	B7443	290
12047680	15497	191	12101907	23146	225			276	13579198	B7440	290
12047767	15499	191	12101909	13548	223	12141493	23132	220	13579204	BH11	292
12048074	18654	191	12101914	23038	228	12159662	17172	217	13580106	23156	220
12048369	14918	217, 242, 276	12101917	13686	211	12160374	20665	298		222, 225, 229, 235,	
			12101922	23184	231			612		239, 245, 248, 252, 254	
12051234	14580	232	12101923	23264	285	12160857	20514	612	13584255	21220	218
12052922	16806	191	12101927	23065	239	12160858	20397	298		276	
12065158	18150	188	12101937	17113	224			611	13584433	17112	226
12066214	14881	192	12101939	18871	231	12167120	23190	220		253	
12066614	20231	194	12102491	23081	231			230, 235	13585316	18868	233
12076946	17175	217	12102568	17463	221	12167121	18867	226	13585849	23211	224
12083005	16585	217	12102601	23012	228			253	13585860	23221	223
12083006	16586	217	12102620	16693	232	12167658	23275	227	13586114	17110	232
12083460	18924	218			256	12176839	23089	298		254, 256	
12083680	17172	217	12102621	14580	232			612	13586977	BH11	292
12083689	17173	217	12102664	21490	218, 237	12176844	19853	612	13589425	B9005	291
12084595	15948	189			243, 263, 268, 274	12186456	20220	193	13590791	B880	291
12084912	20209	194	12102675	23158	225	12186457	20221	193	13591403	B7443	290
12084913	20210	194	12102696	23196	231	12187091	17111	227	13591404	B7443	290
12085270	20752	198			255, 272	12191645	16351	213	13596816	B7440	290
12085330	17174	217	12102747	17110	232	12337831	20892	569	1370853	12735	583
12085485	19882	237, 257, 262			254, 256			576, 598		649, 851	
			12102748	18527	232	12337852	14031	583	1377030	10365	585
12085485	23181	222, 235, 240, 248, 259, 266			257	12337868	15518	620	14002811	13002	140
			12102748	18527	232	12337873	10054	149	14003784	16986	37
12085487	23157	229, 239			256	12337898	17341	439		106	
			12102748	18527	232	12337915	15490	342	14004876	12931	171
12085490	16968	221, 248, 269, 277	12102757	19555	237	12337916	15783	38	14005097	16248	140
			12102763	23260	230, 240			40	14005953	14977	38
12085491	16968	221, 248, 269, 277			240	12337917	12669	116		40, 139	
			12103360	20230	194			151	14007510	13231	38
12085492	23032	222, 248, 269, 277	12103381	15497	191	12337920	12737	506		39, 139	
					191			509	14007510	13232	38
12085495	18868	233	12110250	23071	229	12337966	11630	117		39, 139	
12085496	17114	221			254, 272, 278			152	14007511	14976	38
12085497	18524	232	12110842	20217	193	12338011	15467	439		39, 139	
12085498	16694	217, 242, 276	12110843	20219	194	12338015	17437	624	14007940	12999	139
			12110844	20218	193	12338025	13009	140	14008227	12210	171
12085500	23254	240	12110845	20222	193	12338034	15453	431		433	
12085501	23081	231	12110846	20225	194	12338074	16936	624	14011722	11109	38
12085502	16964	232	12110847	20224	193	12338089	12594	587		41	
12085503	16514	224	12112171	13644	237	12338096	12824	588	14011819	23736	625
12085503	23018	225			261	12338100	15518	620	14013246	13960	583
12085506	18918	221	12116257	23145	235	12338114	9112	165	14017701	12930	171
12085521	23017	225	12116958	17111	227	12338123	2775	22	14017705	12923	171
12085524	23147	235, 284	12117025	23046	219, 225	12338146	10052	148	14017779	12947	173
					229, 234, 239, 243	12338153	11621	347	14017780	12924	172
12085525	17109	223			252, 254, 258, 263	12353912	15463	438	14019205	12567	539
12085526	17109	223	12117260	14918	217	12354949	11083	205		570, 602, 657	
					242, 276	12354969	15948	189	14019205	14007	539
12085527	17109	223			229	12354970	15937	189		570, 602, 657	
12085528	17109	223	12117277	23050	219	12355104	9481	187	14019206	14007	539
12085533	17199	228	12117333	23035	219	12355107	14150	189		570, 602, 657	
12085535	23256	221, 230	12117361	17109	223	12355107	14153	190	14019225	14007	539
			12117367	11439	215, 241, 281	12375975	22453	620		570, 602, 657	
12085537	23124	224, 235, 239	12117367	23142	282	12384935	24285	330	14019226	14011	537
			12117369	22931	219	1244839	9965	598		570, 602	
12085538	18917	233	12117384	13547	223			864	14023108	12925	172
12085539	23252	240	12117385	17107	232	12450053	18001	286	14025274	12916	172
12089040	14150	189	12117387	18145	188	12450176	20595	288	14027471	12759	462
12089188	14151	189	12124075	20214	191	1247872	15459	619		509	
12089189	13659	182	12124076	20215	191	12530252	17654	343	14027775	20799	432
12089190	13669	182	12124304	15938	194	12531204	23970	353	14027776	20800	432
12089191	13678	182	12124515	8774	192	12531209	19441	635	14029095	12940	173

O.E.M. INTERCHANGE BY MANUFACTURER

OEM No.	Auveco No.	Page No.	OEM No.	Auveco No.	Page No.	OEM No.	Auveco No.	Page No.	OEM No.	Auveco No.	Page No.
1403114	12926	172	15300530	19882	237, 262	15691595	19424	623	1618890	23309	581
1403114	23391	172				15694099	18391	489, 512	1619321	12137	462, 509
1403144	12916	172	15305801	23268	236				1619321	16263	462, 511
1403145	12932	173	15305874	22773	218, 224, 228, 238	15694193	16936	624	1621253	12935	171
14032200	14008	569, 570				15704030	19515	354	1631564	15478	462, 510
			15305887	23261	240	15705372	11246	581			
14032291	14009	585	15305925	23262	240	15707256	19317	72, 617			
14037239	18926	620	15305932	18524	232	15709521	18262	616	1635218	12999	139
14039261	23789	80	15305942	23053	226, 234	15714775	11655	582	1636632	16624	538, 604
14039420	14001	537, 570, 598	15306002	23081	231	15714775	11871	582			
			15306009	23124	224, 235, 239	15715058	17654	343	1638575	19162	147
						15718794	13755	341	1640810	15373	43, 51, 91, 97
14045480	14010	564, 570, 602, 657	15306031	23016	234, 257	15732202	18028	341			
						15733970	19614	586	1644290	18948	451, 495
14047034	12929	171	15306045	23054	231	15733971	19613	586			
14048060	13005	140	15306086	23014	219	15737532	12520	129, 130	16500308	14016	524, 570, 603, 657
14051674	15518	620	15306087	23015	219	15737533	12522	129, 130	16502342	20301	64, 67
14063981	13750	342	15306157	21006	218						
14066728	17437	624	15306189	23221	223	15745990	20527	586	16503329	14002	583
14070914	13749	341	15306194	23131	220	15745991	20529	586	16510893	15676	583
14071289	14011	537, 570, 602	15306195	23016	234, 257	15762170	14921	449, 510	16514113	23954	580, 602
						15762170	18302	450, 512, 672, 703	16517439	14021	450, 510
14074081	14036	456, 510	15306302	17111	227	15763285	14921	449, 510	16524326	18661	288
			15306329	22934	232				16524431	18662	288
14078435	11852	346	15306349	22774	222	15769308	21290	619	1654047	11345	437
14082956	18817	42, 49, 90, 95	15306398	22775	218	15772605	16908	286	1660123	11717	587
			15324824	23124	224, 235, 239	15773445	14753	540, 638, 656	16607593	14967, 647, 662, 665	619, 666
14083173	14820	617, 644	15326410	19836	451, 514	15802005	571, 601, 21338	460, 517			
						15822417	21474	211	16629237	18393	619
14090382	19278	43, 52, 91, 97	15328724	16352	213	15828918	18001	286	16629990	19658	620
			15502538	8931	339	15864780	22037	597	16630688	21196	620
14090908	16026	302	15505451	16251	140	15864780	22803	597	16630689	21197	620
14093088	14020	565, 570, 608	15506827	14012	341	15864780	22803	597	16632193	16936	624
			1550971	18474	287	15872008	20884	596	16640343	19658	620
14093311	10831	457, 509	15516462	18749	355	15893516	20885	593	16659130	20279	507, 514
			15545178	18926	620	15924986	25052	610			
14093869	14980	110	15545202	15670	507, 511	15931605	21379	503, 517	16662182	19519	614, 663, 666
14101262	15702	565, 571, 608									
			15562609	16937	625	15944588	21248	460, 516	16674629	20189	459, 514
14103026	12084	345	15567924	15459	619				16675980	19658	620
14103438	15042	571	15569071	20797	432	15953247	17649	507, 511	16715497	17468	342, 352
14103461	15043	571, 607	15569072	20798	432	15953718	17649	507, 511			
			15588024	13946	507, 509	15953718	17649	507, 511	16723225	12084	345
142451	20292	287				15954398	23866	439	16723225	17427	346
142452	16911	286	15588078	14032	456, 510	15955172	19429	585	1688094	11425	587
142453	18015	286				1595523	13752	342	1689827	12095	42, 48
142454	16926	286	15591860	19424	623	15956062	17654	343			
142456	16923	286	15596279	14031	583	15956470	18169	353	1699250	24181	455, 522
145525	14388	296	15596280	14037	585, 650						
1477728	5592	474, 509	15596301	13946	507, 509	15958694	11146	457, 509	1732326	12315	625
						15959832	18268	566, 609	1746408	18817	42, 49, 90, 95
1480627	8359	148	15598757	15792	38, 40	15959833	18334	566, 573	17988488	14820	617, 644
1494251	15677	148	15600382	12992	507, 509				17997722	14820	617, 644
1494252	8359	148				15960325	18353	530, 609			
1494253	10830	148	15607165	15970	507, 511	15960621	19355	529, 573, 603	19115561	11083	205
1494254	10054	149				15963179	16938	490, 511	19115586	19199	205
1494257	10051	148	15612948	15970	507, 511	15964853	13966	141, 807	19115640	21476	211
1494258	8814	148				15964971	16936	624	19115673	17112	226, 253
1494258	10052	148	15614746	21028	341	15964972	16937	625	19116359	21475	211
15002520	18262	616	15614774	18244	354	15967691	19424	623	19119304	21752	213
15014352	20943	530, 576, 600	15622490	17615	349	15969147	19424	623	19130464	20397	298, 611
			15622490	23861	350				19168447	13669	182
15015804	18889	357	15638413	16938	490, 511				19168448	19262	182
15029828	4369	430				15964971	16937	625	1917104	17111	227
15031239	17654	343	15641800	11110	38, 41	15969147	17216	557, 641, 659	19179280	22935	226, 280
15033681	20860	614				15975244	19834	459, 514			
15035237	25193	586	15647709	23856	439				19183888	20758	749, 829
15040331	21290	619	15648833	14988	526, 571, 637	15985762	23866	439	19183917	20757	749, 829
15045388	21195	434				15986343	18371	456, 512			
15056810	20362	461, 515	15650655	9880	146	15986673	19356	490, 513	19206781	15499	191
			15653790	19781	623	15989431	21380	464, 517	19209790	21828	213
15061964	21195	434	15672183	19782	623				19209791	1829	213
15076791	20444	503, 515	15672328	17599	508, 511	15990756	18030	539, 658	19209792	21830	213
						15993201	16622	572, 658	19209793	21831	213
15078238	20860	614	15672330	14998	560, 571, 601	15993201	16622	546, 605	19209794	21832	213
15116576	20935	594				15994165	20542	537, 575, 604	19209795	21833	213
15127746	20934	593	15672713	18167	347				19209796	21834	213
15149708	19639	538, 573, 604, 640, 658	15678493	17215	465, 511	1600375	10759	581	19209797	21749	213
						1600375	23310	581	19209798	21750	213
15153415	19615	558, 573, 607	15678979	18948	451, 512, 795	1600375	10759	581	19209799	21751	213
						1605396	11146	457, 509	19209800	21752	213
15175428	12930	171	15679091	14953	568, 636	1605396	11146	457, 509	19257054	B9006	292
15203303	BH13	292				1605396	11146	457, 509	19257055	B9004	291
15209748	21106	211	15681408	17103	534, 572, 603, 640	1606642	11657	581	19257057	20599	288
15221959	20865	592				1610403	12917	172	19257058	B9007	292
152266	8375	148	15682898	18262	616	1611249	20364	43, 55	19257375	17112	226, 253
152267	8372	148	15683327	21387	613						
152273	15677	148	15685040	19424	623	1614858	12931	171	19258649	21006	218
15236893	20951	596	15685099	20415	618, 646	1617333	12919	172	19260056	21487	622
15236894	20952	592				1618890	11470	581, 665	19260058	21404	621
15265199	25051										

O.E.M. INTERCHANGE BY MANUFACTURER

OEM No.	Auveco No.	Page No.	OEM No.	Auveco No.	Page No.	OEM No.	Auveco No.	Page No.	OEM No.	Auveco No.	Page No.
19260663	21072	621	20451401	13461	506, 509	21077123	19801	534, 573, 640	22704458	20634	489, 515
19299324	20485	621	20452072	13751	342	21077131	17616	567, 572, 609	22713392	20634	489, 515
19299616	21220	218, 276	20453400	12064	80	21077323	17226	535, 572, 604	22717568	20483	643
19300089	13659	182	20455900	14006	450, 510	21077405	17227	524, 572, 601	22718305	15480	460, 510
19300091	19262	182	20462090	16865	448, 597	21077575	18033	472, 511	22718369	21238	566, 577, 602
19304003	23265	230	20465395	14005	341	21093588	17219	588	22718369	22459	554, 579
193065	18474	287	20477732	16687	351	21094146	16818	455, 511	22722859	20634	489, 515
19326896	15948	189	20478294	13860	610	21094240	18515	80, 84	22722860	20635	586
19329253	17112	226, 253	20480475	13453	506, 509	21094747	17220	341	22722860	23552	489, 522
19329253	23020	222, 269	2048248	11673	461, 509	21095797	18896	560, 573, 607	22755704	25053	430, 620
19329763	20485	621	20487630	15463	438	21098967	19397	438	22761970	25033	585
19332887	22174	622	20487631	17341	439	21101045	16816	529, 572, 603, 656	22884291	22430	585
19352194	22088	352	20510029	13993	540, 570, 604, 640	2110201	16818	455, 511	22917201	2106	211
19352782	20934	593	20514862	15367	453, 510	2110767	19397	438	24100042	21047	314
19352782	21374	593, 654	20538173	18302	510, 512, 672, 703	21192748	20482	643	24100042	24265	315
19353806	21286	358	20547865	14147	565, 570, 608	2201406	12522	129, 130	2419255	8905	339
19353806	21286	358	20551451	13454	453, 509	2201407	12520	129, 130	24205245	20528	449, 515
19353808	18810	357	20570245	13994	565, 570, 608, 642	2201407	12520	129, 130	24405740	22022	590
19353809	25108	358	20582532	18392	619	2207713	16132	458, 511, 863	24449408	21540	114, 150, 809
19368868	21220	218, 276	20582533	18393	619	22189414	20360	459, 515	24501057	21090	460, 516
1999366	16898	288	20582533	18393	619	22505958	12934	171	24571185	16026	302
1999437	89005	291	20585900	23079	226	22508049	12932	173	24571185	24343	302
1999482	20620	287	20590899	13996	540, 570, 604	22508050	12918	172	24574578	14988	526, 571, 637
20003056	20427	503, 515	20603072	11152	436, 437	22508051	12937	171	2477054	8895	338
20030401	15457	465, 510	20612732	13746	341	22508052	12927	172	2495701	8938	339
20032850	11679	453, 509	20612732	13746	341	22508803	11419	173	25015169	12237	215, 241
20037240	23649	587	20626174	19394	440	22512276	12766	461, 509	2501569	12237	215, 241
20037597	12314	625	20633148	18392	619	22512276	16262	461, 511	25016383	11612	451, 509
20046147	14559	623	20633149	18393	619	22512857	12605	582	25016383	11680	451, 509
20058837	18398	447, 597	20633504	15463	438	22513813	12605	582	25117765	18925	221
20064875	11130	465, 509	20635065	13994	565, 570, 608, 642	22527720	14035	456, 510	25508532	12566	585, 650
20064875	15456	465, 510	20641977	18218	250	22529733	2293	146	25512081	12729	613
20085729	17073	440	2064891	10621	506, 509	22531616	11631	117, 153	25512688	19162	147
20097200	12569	627, 649	2064891	16260	506, 511	22535007	15044	566, 571, 608	25514221	11675	453, 509
20099254	23742	625	20652520	18679	462, 512	22536642	18298	450, 512	25522466	9285	328
2011554	12084	345	20664091	14753	540, 571, 601, 638, 656	22538004	14993	540, 571, 776	25522466	24210	329
2011554	17427	346	20664092	14753	540, 571, 601, 638, 656	22538004	23826	539, 580, 600	25524005	14004	341
20123070	15467	439	20687704	16624	538, 571, 604	22538004	23826	539, 580, 600	25527289	14822	144
20130258	13002	140	20699808	14921	449, 510	22538102	14990	526, 571, 599	25530441	14527	147
20130258	13003	140	20712172	15463	438	22542705	15045	566, 571, 608	25535963	19472	610, 643
20130258	23497	37	20712176	15463	438	22547243	15543	458, 510	25536302	14820	617, 644
20160591	15466	439	20713843	15684	347	22566142	15684	347	25554845	19361	587
20162174	17176	439	20732399	10831	457, 509	22569178	18927	354	25580123	19519	614, 663, 666
20171942	12594	587	20734005	17092	507, 511	22579423	18927	354	25601491	18174	455, 511
20173225	19817	434	20742994	23831	587	22587036	18310	565, 573	25603960	18389	450, 517
20175051	12563	587	20747508	17341	439	22587341	12081	345	25605716	14527	147
20175890	23720	588	2075380	19055	339	22595587	14988	526, 571, 637	25609048	17641	355
20184399	11621	347	2084421	8774	192	22595723	18930	504, 512	25612368	22058	529, 578, 637
20199675	14642	588	2085119	16940	356	22599312	20263	437, 588	25612415	22459	554, 579
20200750	18510	467, 512	2085119	19057	339	22600612	18930	504, 512	25618730	17121	354
20227160	23907	522	2085823	19060	339	22600612	18930	504, 512	25630331	19411	588
20237057	12602	588	21006725	18023	314	22600612	18930	504, 512	25631448	19417	62
2024778	19338	357	21021319	18749	355	22600612	18930	504, 512	25634894	23608	451, 521
2024781	8300	339	21030249	17216	557, 572, 606, 641, 659	22600612	18930	504, 512	25640501	3138	143
20274997	12824	588	21030249	17216	557, 572, 606, 641, 659	22603384	19820	592	25642453	17103	534, 572, 603, 640
20298365	11677	506, 509	21039129	17975	466, 511	22638717	13750	342	25648693	20280	588
20319841	12731	461, 509	21039141	17215	465, 511	22642756	20262	461, 514	25649667	20466	585, 629
20325696	12656	349	21042045	17218	488, 511	22643056	18889	357, 528	25655537	10831	457, 509
20328600	15467	439	21042053	17218	488, 511	22644361	19522	573, 603	25663903	20265	565, 575, 601
20340710	15463	438	21042058	17218	488, 511	22646099	19428	505, 513	25670009	18848	488, 512
20345137	14549	624	21042098	17214	526, 572, 599	22649878	11691	583	25672428	20279	507, 514
20346654	14217	612, 643, 665	21042104	17218	488, 511	22649879	11691	583	25680782	14991	539, 571, 600, 638
20348200	12315	625	21042108	20829	487, 515	22651066	18930	504, 512	25693852	19822	592
20351035	12065	80, 86	21047094	16816	529, 572, 603, 656	22657634	19787	527, 573, 600	25695687	19892	567, 573, 602
20353101	23860	434	21075686	17222	534, 572, 603, 640	22691056	21091	488, 516	25704358	21428	585
20363491	13999	524, 570, 603				22699649	20634	489, 515	25705182	21517	45, 62, 93, 106, 610
20374473	12737	506, 509									
20375100	23939	358									
20376243	4441	429									
20413107	11612	451, 509									
20421672	13752	342									
20421800	12992	507, 509									
20423550	15774	49									
20423647	13747	341									
20426301	14260	532, 570, 599, 766, 841									
20429500	14553	624									
20432975	13748	341									
20433026	13753	342									
20451119	13457	539, 570, 599									

O.E.M. INTERCHANGE BY MANUFACTURER

OEM No.	Auveco No.	Page No.	OEM No.	Auveco No.	Page No.	OEM No.	Auveco No.	Page No.	OEM No.	Auveco No.	Page No.
25707329	20244	549, 610	362069	11638	81, 87	4457595	10220	587	5963268	11156	215
25718851	20326	590	362379	11245	581	4459049	9342	447	5973400	12757	565, 602
25722267	20318	589	363137	15461	506, 510	4492962	10318	588		19847	562, 602
25724529	19822	592				4492962	11288	587	5973400	19847	573, 602
25724529	20774	593	365266	11826	581	4495047	9367	618		19847	562, 602
25732397	21081	64, 67	365270	11718	582	4533699	8583	436	5973823	19847	573, 602
			3655015	4233	429	454626	16919	286		12756	565, 603
25742293	20976	591	3664645	4237	429	454646	18004	286	5973996	12756	570, 603
25744385	21503	596	367291	14976	38, 39, 139	455136	16920	286	612019	9298	126
25749564	21227	465, 516	367292	12995	139	455490	16918	286	6270163	19418	469, 513
25774893	21375	597	3688699	8963	883	4564974	4264	429	6271904	20803	432
25775903	21335	597	3688811	4235	429	4565415	4240	430	6271989	14559	623
25803643	22026	584	3689084	4236	430	4619387	23726	625	6272766	12918	172
25822063	21287	463, 517	3693292	4230	430	4628769	19626	864	6276604	3617	447
			371168	4265	429	4637277	20175	864	6280765	3617	447
25832258	22372	72, 584	3722635	2619	865	4657731	2628	437	6288704	8777	190
			3722635	12958	865	4676189	19807	865	6294493	13548	223
25910528	23985	63, 65	3725377	23755	626	4689929	2744	864	6294737	15935	191
			3744999	2752	865	4699315	2619	865	6298886	9883	215, 280
25922739	21370	595	3744999	12960	865	470434	20796	432			
271022	10773	125	3745361	4280	429	471064	23795	42, 50	6298886	11166	241, 280
274007	18473	287	3762180	4265	429	4721222	4281	430			
279670	12523	129, 130	3762180	4280	429	4723818	2789	864	6298886	13558	216
			3764017	23725	625, 626	4723818	12961	864	6298892	9883	215, 280
279670L	12521	129, 130	3783002	5278	64, 65	472434	11699	539, 570, 602, 656	6298892	13558	216
279670R	12523	129, 130	3783006	5228	71	472450	15453	431	6298935	9883	215, 280
279671	12521	129, 130	3783794	5195	141	472812	12935	171			
2898909	23608	451, 521	3803070	8418	72	472814	12921	172	6299087	11157	215, 267
			380382	9829	583	472815	12922	172			
2962447	8774	192	3828472	18329	354	4730773	20175	864	6466355	12920	172
2962448	8777	190	383569	8623	37	474821	14976	38, 39, 139	7634583	9275	436
2962510	11440	231, 272	383569	8624	37	475299	8435	71	7637192	4441	429
			3846202	15783	38, 40	4759145	2943	864, 598	7642589	13467	466, 509
2962984	8775	190	3866846	15345	127	4761842	2943	864, 598	7693140	9639	436
2962987	8776	192	3876130	16240	140	476737	23887	883	7698976	9633	436
2965142	15957	192	389089	13757	467, 509	4767559	4446	429	7724826	4447	429
2965470	14892	196	3893980	10330	583	4770719	24147	613	7730788	9749	436
2965580	15504	196	389809	13757	467, 509	477814	2744	864	7731589	9850	446, 587
2973215	18690	192	389809	13757	467, 509	4779348	2943	864, 598	7731589	10632	446
2973216	18651	192	3899596	14030	584, 851	4801268	3620	473, 509	7743519	23754	625, 626
2973932	9905	214, 215, 267, 280	3900684	4369	430	480534	10832	457, 509	796255	11349	505, 509
2974309	8756	280	3907444	8435	71	4853108	8398	865	821240	18952	186
2977373	11442	223	3907444	11719	71	4856651	24285	330	84221533	22835	586
2977607	11444	223, 270	3919773	11691	583	4872948	4446	429	84221534	22430	585
2978302	8755	280	3920179	11352	613	4876498	10744	468, 509	8654382	9278	328
2978302X	8755	214, 280	3921446	9851	582	4877001	8386	865	8717859	10243	436
30000784	23962	522, 816	3921988	19130	311	4877979	23563	613	8731909	11120	450, 509
30006620	19257	499, 513, 754, 838	3923948	10090	583	4887980	23563	613	8733059	10318	588
30012018	14696	531, 570, 713, 733, 798	3927320	9481	187	490067	11770	37	8733059	11288	587
30020637	20908	551, 576, 816, 844	3944866	12971	598, 864	490067	11771	37	8734067	10242	436
3062615	23646	587	3946988	2710	19, 417	513388	4243	429	8736585	9749	436
3065575	11796	506, 509	3960314	10362	38, 40	516637	8744	129	8736586	9639	436
			3963228	11738	172	528846	13004	140	8763591	9633	436
3065575	16261	506, 511	3970076	12922	172	5297428	18952	186	8799350	10617	587
			3977775	11130	465, 509	534343	11831	613	88860426	9883	215, 280
3078511	11130	465, 509	3982098	8359	148	547944	4439	171, 433	88860429	8756	214, 280
325338	23617	613	3984469	10653	22	5480766	19505	827	88860432	12237	215, 280
3297373	11442	223	3985058	11424	583	5480772	20863	561, 576, 607	88860434	9905	214, 280
332364	10831	457, 509	3986997	11109	38, 41	5480852	20756	593	88860442	14135	242
			3997391	14030	584, 851	5480853	8889	338	88860444	14130	241
332364	16259	457, 511	3998009	15759	620	5482087	21284	613	88860446	23035	219
342271	16253	140	4001934	13467	466, 509	5482103	20881	482, 516	88860447	13559	216, 267
343541	11243	581	400765	4474	431	5485676	17216	557, 572, 606, 641, 659	88860448	23012	228
343543	11246	581	406511	12922	172	549790	11640	81, 88	88860452	18671	251
343555	11243	581	407217	11110	38, 41	554343	11831	613	88860453	17661	253
343555	11245	581	4081765	4188	429	55568037	21650	316	88860454	23015	219
343555	11246	581	409988	4417	424	55577568	22360	314	88860455	23014	219
345510	11554	215	411700	11721	451, 509	556992	12932	173	88860458	20837	242
347065	16237	140	4137121	4242	429	557057	11655	582	88860463	18668	248
347347	13450	583	413945	8744	129	557057	11871	582	88860464	23080	226
347893	11292	144	416629	12069	444	557057	12605	582	88860469	23028	243
3533539	16940	356	4234830	15518	620	559312	11655	582	88860471	23078	270
3533539	19057	339	4301446	15759	620	559312	11871	582	88860474	19582	251
3536964	24241	314	444613	9278	328	560625	12937	171	88860476	20839	253
3536966	18665	303	444619	9279	328	560692	11419	173	88860480	17621	254
3538469	21047	314	444620	9279	328	562327	11831	613	88860481	17622	255
3538874	18394	566, 573, 660	444667	9285	328	5655006	9905	214, 215, 267, 280	88860482	20389	268
			444677	9283	328	568792	19626	864	88860483	23090	239
3540161	16940	356	444777	9283	328	568792	19627	864	88860484	20610	499, 515, 708
3540161	19057	339	444789	9285	328	574355	19626	864	88860485	18530	237
354076	11246	581	445078	24233	311	574355	19627	864	88860486	17624	261
3540858	18308	549, 573, 606	445429	11292	144	575411	2789	864	88860487	17623	253
			445792	11292	144	575411	12961	864	88860488	17598	251
354400	12939	173	445792	11292	144	588546	15037	42, 47	88860488	23168	252
357020	12918	172	445792	11292	144	5949838	3178	582			
358501	8746	129	445792	11292	144	5953005	5788	582	88860489	17684	261

O.E.M. INTERCHANGE BY MANUFACTURER

OEM No.	Auveco No.	Page No.	OEM No.	Auveco No.	Page No.	OEM No.	Auveco No.	Page No.	OEM No.	Auveco No.	Page No.
88860489	23169	265	88861094	23199	249	88909769	12547	213	8912750	13540	216
88860490	23033	257	88861095	20848	242	88909770	15505	213	8913369	14885	197
88860492	18525	218	88861096	20352	251	88909771	15506	213	8914822	11154	215
88860494	23037	263	88861099	23126	284	88909772	15507	213	8914822	11475	215
88860495	18463	261	88861101	5226	214	88909773	15508	213	8914823	11476	215
88860496	20277	262	88861106	23196	231	88909774	15509	213	8915135	23010	202
88860497	18819	261			255, 272	8891030	15673	620	8915136	12628	202
88860498	14130	241	88861107	23096	222			662	8917293	17002	192
88860499	18215	256			248, 269, 277	8891031	15673	620	8917320	14547	298
88860501	20841	253	88861108	23109	281			662			612
88860502	18216	256	88861353	12552	213	88938226	14921	449	8917444	11083	205
88860504	23139	265	88862211	16514	224			510	8918527	9883	215
		275	88862213	18217	253	88953146	23134	220			241, 280
88860505	11440	231			261			276	8918527	11166	241, 280
		272	88862214	14580	232	88953267	22776	224			280
88860507	19076	254	88862215	17112	226		228, 238, 270, 274	224	8919916	13543	216
		261			253	88961517	12669	116	8933059	10318	588
88860508	23039	258	88862216	17109	223			151	8933059	11288	587
88860509	20172	255	88862217	16694	217	88969790	20576	481	90058568	23859	522
88860510	20547	262			242, 276			515, 835	90321122	21088	483
88860511	20548	262	88862218	17107	232	88970345	20559	493			516
88860512	18673	261	88862219	18918	221			493			558
88860514	20246	262	88862220	16693	232	88970493	17481	819	90450482	25222	580, 777
88860515	20550	263			256	88970494	20577	549			303
88860518	17598	251	88862221	23079	226			549	90543942	24355	491
88860519	23009	238	88862222	23145	235	88970495	20578	588	90560163	22336	491
88860520	23040	258	88862223	16967	220			821			521
88860521	23041	263			227, 284	88970656	20575	496	9117148	18661	288
88860522	19889	257	88862226	17110	232			496	91173701	15926	211
88860522	23043	258			254, 256	88970747	19729	476	91176726	20417	592
88860524	19885	254	88862227	18917	233			476	9130754	22552	531
88860526	19126	242	88862228	17111	227	88970766	21687	759			579
88860527	19125	242	88862229	17114	221			848	9132667	22088	352
88860530	23120	219	88862230	17113	224	88970767	20869	463	92095787	BH11	292
		245, 268	88862232	16964	232			463	92138636	22219	546
88860532	23180	265	88862233	23158	225			516, 540, 576			579, 604
88860535	23122	245	88862235	17683	256	88973654	20578	588	92138807	22226	596
88860536	23121	245	88862238	18527	232			821	92138808	22225	596
88860537	20844	253			256	88973676	20577	549	92138811	22220	520
88860538	19157	256	88862238	23034	234			549	92138865	22222	590
88860544	23182	266			237	88974848	20575	496	92138942	20515	500
88860546	19881	262	88862241	13644	237			496			515
88860547	23186	255			261	88981030	15674	620	92139070	22224	589
88860548	23212	252	88862247	17690	237			620	92139150	22089	351
		266	88862254	23196	231	88981031	15673	620	92231490	18501	341
88860549	11436	236			255, 272			662	92231490	19781	623
88860550	23123	274	88862255	18674	232	88986416	23127	219	93356553	1981	623
88860551	19880	257	88862257	23179	229			276	94051993	16859	530
88860552	20549	251	88862260	18870	233	88986451	18868	233			572, 600, 798
88860553	23183	273			253, 256	88986460	25210	227	94133167	23807	522
		275	88862261	23045	277			236, 278, 279			733
88860557	23437	230			283	88987184	23053	226	94145515	17076	459
		255	88862262	17199	228			234			511, 733
88860559	19623	253	88862264	21490	218	88987185	23262	240	9414716	3079	21
88860563	23052	264			218	88987187	21220	218	9414722	1943	21
88860566	23047	264	88862267	19882	237			276	9414723	2808	21
88860567	23049	271			257, 262	88987962	17109	223	9414767	2734	19
88860571	23222	268	88862269	23256	221	88987992	22936	223			417
88860579	23262	240			230			278	9415465	2366	21
88860584	11444	223	88862270	23092	230	88987993	23016	234	9416042	2712	19
		270			231			257	9416444	2709	19
88860585	11445	250	88862271	18925	221	88988117	23059	244	9416927	16909	286
88860586	13541	216	88862272	23046	219	88988139	23061	244	9417276	1937	21
		267			225, 229, 234, 239	88988301	18527	232	9417561	20285	287
88860588	20849	263			243, 252, 254, 258, 263			256	9417863	16906	286
88860589	23048	264	88862274	19555	237	88988447	19582	251	9417866	16904	286
88860591	23213	246	88862279	23198	271	88988609	21212	228	94178705	18876	498
88861015	5220	214			273	88988963	24202	223			512, 837
88861017	5225	214	88862280	23081	231			249, 260	9419740	5655	20
88861018	8759	214	88862281	23260	230	8900524	11948	191	94198687	14697	529
88861020	8761	214			240	8901283	11166	241			570, 599, 713, 765
		241	88862282	23187	285			280	9420052	12097	43
88861022	17690	237	88862283	23050	229	8902487	11446	215	9420850	11923	21
88861047	5196	141	88862284	23124	224	89025539	20485	621	9421330	16902	286
88861048	23111	281			235, 239	89025546	21072	621	9421330	20285	287
88861049	23220	282	88862285	23264	285	8903202	11154	215	9421777	16911	286
88861050	8764	214	88862286	23259	231	8903202	11475	215	9421777	16912	286
88861067	23155	275	88862287	23053	226	8903203	11476	215	94218027	17195	630
88861068	23263	285			234	8903283	11446	215			651, 692, 733, 782
88861069	23125	284	88862288	23261	240	8903489	12628	202	94221150	14727	569
88861070	23189	285	88862290	23054	231	8904437	11156	215			571, 733, 801
88861071	23188	285	88862292	23190	220	89046837	23211	224	9422339	18469	286
88861072	2319	259			230, 235	89057707	18218	250	9422552	11292	144
88861073	13548	223	88862295	23265	230	89057711	17620	251	94226492	14269	498
88861073	23141	224	88862296	19813	262	89057714	13548	223			510, 733, 764, 838
88861075	20561	263	88862300	23219	246	89057715	23196	231	9423101	19777	64
88861076	23193	255	88862301	20846	250			255, 272			66
88861078	20843	251	88862302	17463	221	89057717	20838	250	9424837	9880	146
88861079	23215	246	88862303	16968	221	89057718	19887	262	9425491	9881	147
88861080	23216	246			248, 269, 277	89057721	11440	231	9425542	16921	286
88861082	23217	246	88891731	19424	623			272	9425542	20706	293
88861083	23218	246	88891787	21047	314	89057722	11442	223	9426331	12547	213
88861084	20845	257	88891787	24265	315	8905794	20471	298	9426334	12545	213
88861085	23202	259	88891791	18889	357			611	9427587	18013	286
88861087	23195	245	88909758	12548	213	8909518	11156	215	9427761	10666	143
88861089	20853	253	88909760	12536	213	8909908	11446	215	9427882	9282	328
88861090	23269	249	88909760	12550	213	8911472	14546	298	9427909	8925	339
		255, 260, 270, 272, 273	88909761	12551	213			611	9428481	3796	143
88861091	20851	250	88909762	12552	213	8911473	14544	298	9428902	16899	286
88861092	23203	266	88909763	12553	213			611	9428904	16901	286
88861093	23201	246	88909764	12554	213	8911497	14545	298	9431530	9880	146
		259, 266	88909765	12555	213	8912698	11157	215	9431532	10067	147
88861094	20842	248	88909766	12556	213			267	9431647	2293	146

O.E.M. INTERCHANGE BY MANUFACTURER

OEM No.	Auveco No.	Page No.	OEM No.	Auveco No.	Page No.	OEM No.	Auveco No.	Page No.	OEM No.	Auveco No.	Page No.
9431808	16913	286	94858864	19645	529	71598-S30-013	20677	692	90601-S30-003	22926	670
9431809	18011	286			573, 599	72311-S10-003	19673	451			702
9432137	16687	351	95005064	14144	499, 510, 838		513, 709, 769, 848		90601-SH3-014	17442	696
9432552	16686	350			502, 513, 839	72311-S5S-003	21704	471	90601-SMG-003	22242	693
9432645	11246	581	95008221	19129	546, 577, 605		518, 671, 709		90601-SNV-P01	25267	670
9433040	18010	286	95230842	21529	129	72431-S2X-003	21639	668, 694			701
9433043	11628	152			129	73154-T0A-003	22857	669, 698	90602-S2A-003	21696	480, 705
9433143	20286	287	9590477	12675	129			698	90602-S5A-003	21059	501, 516, 674, 708
94331546	20582	146	9591699	12695	129	73154-TA0-A01	22273	698	90602-S7S-003	20611	480, 515, 705
9433155	9879	146	9601750	20562	619	73156-T0A-003	22165	699			
9433156	20582	146	96057293	23961	522, 590, 816	73862-672-003	14299	467, 510, 709	90602-SAA-003	21087	499, 516, 707
9433184	18016	286			532, 572, 601, 841			467, 510, 709			
9433186	18168	356	96057846	17162	526, 572, 601, 816, 840	73862-672-0030	14299	467, 511, 705, 832	90602-SJK-003	22560	695
9433373	10171	19			449, 510, 762			479, 511, 705, 832	90602-SX0-003	21107	483, 516, 673, 706
9433489	11614	36	96057847	17383	449, 510, 762	74842-659-003	16779	479, 511, 705, 832	90602-TA0-003	21417	673, 706
9433489	11615	36			573, 844						
9434229	18732	339	96061699	14367	42	74842-659-0030	16779	479, 630, 768, 817	90617-TBA-A01	22262	692
9436175	11620	346	96064506	19128	436	75103-SJ4-003	23818	613, 694	90650-T2A-003	25067	692
9436750	16922	286			436			694	90651-S4N-003	19749	471, 514, 834
9436789	18465	286	9616231	23610	436	75305-S0A-003	20783	694	90651-T2M-003	22553	467, 521, 709
9436790	20284	287	9662950	11067	807	75305-SH2-003	20784	694			
9437173	18008	286	9669486	11855	506, 509	75305-SH4-003	20785	694	90651-T3L-003	22469	501, 521, 674, 708
9437348	23724	581			506, 509	75305-SHJ-003	21186	693			
9437486	12655	347	9685057	11678	506, 509	75306-SV1-A01	20602	694			
9437643	20402	347			506, 509	75306-SZA-A01	21470	693	90651-TA0-003	22551	472, 521, 671, 709
9437846	14486	347	97084563	24208	329	75307-SN7-000	20570	110, 717, 781	90651-TG7-000	22586	449, 521, 709
9437938	11621	347	9711304	15759	620			710			
9438068	18012	286	97134978	17355	437, 733	75315-S9A-004	22136	694	90651-TP8-003	21705	471, 518, 671, 709
9438150	11246	581			624, 624, 647	75315-TG7-A01	22465	669, 694			
9438848	16907	286	9721917	14550	624, 647			669, 694	90652-SB2-023	16949	715
9438850	16908	286			437, 733	75315-TP6-A01	22465	669, 694	90653-HC4-900	17222	534, 572, 603, 640
9439559	18749	355	9731301	11152	437			669, 694			
9439719	12657	356			37	75316-S9A-004	21557	668, 694	90655-SA0-003	14288	699
9440178	9879	146	9786454	9354	37			694	90655-SA0-0030	14288	699
9441592	18167	347	9786454	9355	37	75316-TP6-A01	22464	694	90656-671-6310M1	14287	700
9441724	20598	288	9786454	9356	37	75329-SH4-013	21109	694	90657-SA5-003	22199	532, 579, 674, 710
9441731	16896	288	9792217	23680	451, 521	75521-611-000	14274	700, 761, 789, 824			
9441731	B9004	291			45, 521			700, 761, 789, 824	90657-SA6-003	14697	529, 570, 599, 713, 765
9441732	16897	288	9796223	10714	62	75522-611-000	14255	699, 761, 782	90657-SB0-003	19186	525, 573, 674, 710
9441733	16898	288			62			699, 717			
9441770	8938	339	9806723	23761	623	75891-SA7-000	25254	676, 717	90661-SC7-003	14695	700, 761, 782, 790, 826
9441837	18017	286	9808241	10630	436			668, 695	90662-671-003	14313	700, 761, 789
9441838	18000	286	9815325	14967	619, 647, 662, 665	76222-SPI-003	21772	668, 695			
9441839	16915	286			506, 509			677, 715	90662-693-003	14281	700, 827
9441840	16916	286	9818648	10621	506, 509	82871-671-000	25408	677, 715	90662-SB2-003	14313	700, 761, 789
9441854	17998	286			624			329			
9441866	17999	286	9822198	14548	624	8-97084-563-0	24208	329	90664-671-003	14328	510, 709
9441941	2808	21	9828421	23676	588	90009-PH1-000	21353	315	90664-SB3-003	20303	701
9441956	18005	286	9838109	10318	588	90009-PY3-000	22205	317	90665-S47-003	21414	496, 731, 797
9442003	17996	286	9838109	11288	587	90009-R70-A00	22205	317			
9442081	17997	286	9854717	10631	436	90066-PC8-010	24222	321	90666-SA0-003	14289	510, 704
9442361	17641	355	9854717	23956	436	90101-SHJ-A01	25064	670, 702	90666-SA0-003A3	14289	510, 704
9442486	18001	286	9879002	23619	23			702	90666-SA0-003A9	14289	451, 510, 704
9442492	18478	287	9882774	8853	469, 509	90101-TR0-000	22941	83, 676, 717	90666-SA0-003ZD	14289	451, 510, 704
9442879	20683	288			506, 509	90103-SDA-A00	22203	44, 57, 92, 100			
9442881	20599	288			506, 509	90103-TA0-000	22203	44, 57, 92, 100	90666-SA0-0030	14289	510, 704
94467458	17355	437, 733			511	90105-TBA-A00	25224	84, 676	90666-SA0-003A3	14289	510, 704
		611			436	90105-TBA-A00	25224	84, 676	90666-SA0-003A9	14289	451, 510, 704
94530387	25054	533, 576, 600	HONDA			90106-SW3-003	19650	701	90666-SA0-003ZD	14289	451, 510, 704
94530438	21112	533, 576, 600	33102-TLA-A01	25063	693	90107-S0X-A01	21521	670, 701			
94530438	23822	580, 600, 637	33103-S3V-A01	B9005	291			701	90666-SD9-000	20351	699
94530565	21070	494, 516, 725, 738	33111-SR3-A01	18661	288	90107-S10-003	19533	701	90666-SDA-A01	22546	668, 693
94530623	17267	556, 572, 676	33115-S7A-003	B9005	291	90108-S50-003	20331	692			
94530624	18119	559, 573, 715	33115-S84-A01	16897	288	90108-SW3-003	19470	454, 513, 704	90666-TA0-A01	25326	668, 693
94530742	21316	590	33115-S84-A01	B9005	291	90109-SW3-003	19470	454, 513, 704	90667-671-013ZA	20381	476, 515, 703, 783, 795
94748652	22161	589	33116-TA0-A01	B9006	292	90111-SM4-003	22942	83, 676, 717	90667-S0D-003ZC	20334	454, 515, 703
94841130	14277	825	33152-TLA-A01	25063	693	90114-SE0-000	20259	44, 55, 92, 99			
94841226	14750	113	33165-SAA-003	BH11	292	90114-SZ3-000	20259	44, 55, 92, 99	90667-SA0-0030	16776	454, 511, 704, 796
94841764	114, 147, 769, 848	782, 824, 824, 474, 512, 750, 831	33165-TLO-003	16694	217, 242, 276	90212-SA5-003	16470	110, 716	90667-SA7-003	16775	458, 511, 704, 796
94842841	18297	474, 512, 750, 831			290			110, 716			
94847334	17383	526, 572, 601, 816, 840	33301-ST7-J01	B7440A	290	90301-ST0-003	12118	110	90667-SA7-003ZB	16775	458, 511, 704, 796
94848834	15695	818	33303-S2R-003	B7440A	290	90331-S3Y-003	25250	113, 145			
94849113	18297	474, 512, 750, 831	33303-SCK-003	B7440A	290			306	90668-SB0-003	14698	570, 714
94852368	19140	558, 546	33303-SD4-671	16901	286	90402-PC8-010	24321	306	90669-SP0-003ZA	19744	454, 514
94853733	573, 599, 656, 676, 785, 845	546, 573, 754	33303-SZ1-A01	22887	287	90418-SW3-003	19470	454, 513, 704			
94854203	19194	584, 827	34301-692A-0000	14317	699			306	90669-SP0-003ZB	19744	454, 514
94858299	18876	498, 512, 837	34355-SD2-003	15997	692	90441-PK4-000	24320	306	90670-SG0-003	19741	500, 514
94858338	19312	452, 513, 830	34901-SZ3-000	BH1	292	90471-PX4-000	16955	306	90671-SOD-003YU	21303	452, 517, 703
94858343	19726	529, 573, 599	34901-TK8-A01	B921	290	90501-SDR-003	22419	558, 676, 712			
94858343	23935	580, 840	34906-S10-A01	20296	287			702	90671-SOD-003ZK	21303	452, 517, 703
94858509	19729	476, 514, 751, 833	34908-SAO-811	BH3	292	90505-SM4-003	17057	546, 572, 714			
94858560	18873	547, 573									

O.E.M. INTERCHANGE BY MANUFACTURER

OEM No.	Auveco No.	Page No.	OEM No.	Auveco No.	Page No.	OEM No.	Auveco No.	Page No.	OEM No.	Auveco No.	Page No.
90672-SA0-003	14298	299, 716, 769	91503-SWA-A01	22466	669, 696	91530-SPI-003	18877	472, 512, 672, 710	91570-SZA-305	21543	669, 697
90672-SA0-0030	14298	299, 716, 769	91503-SZ3-003	19233	554, 573, 675, 711	91530-ST5-003	19116	472, 513, 710	91570-TA5-A01	25079	669, 698
90672-SNA-A01	22548	715	91503-SZ5-003	20564	557, 575, 675, 712	91531-ST0-003	19359	697	91571-SDA-A01	21096	697
90673-SC6-003	14703	698	91503-TIW-003	22446	554, 579, 711	91531-THR-A01	18302	450, 512, 672, 703	91572-SDA-A01	21094	698
90673-SC6-0030	14703	698	91503-T2A-A01	21796	696	91532-SJA-003	25328	477, 523, 672, 705	91572-SV4-003	23555	698
90673-TY2-A01	25262	676, 717	91503-TK8-A01	22587	696	91533-SG0-000	19186	525, 573, 674, 710	91578-SV4-003	18457	692
90674-SB0-000	14268	700, 826	91503-TLY-H01	25255	696	91534-SE0-000	17443	693	91578-T0A-003	21836	692
90674-TY2-A01	22943	676, 717	91503-TR0-A01	25329	696	91534-SE0-003	17443	693	91591-SJ6-013	21170	677, 715
90674-TY2-A01	22943	676, 717	91504-SDA-003	22518	715	91545-SE0-003	16782	555, 572, 713, 799	91619-SA5-000	14274	700, 761, 789, 824
90675-SA5-003	22105	116, 152, 717	91504-SM4-000	19408	559, 572, 714	91545-SE0-003-WI	16782	555, 572, 713, 799	91619-SM4-003	19117	700
90675-SB0-003	16000	550, 571, 714, 767, 800	91504-SPI-003	21558	668, 695	91547-SE0-003	14688	715	91619-SM4-0030	19117	700
90675-SB3-003	16000	550, 571, 714, 767, 800	91504-TBA-A01	22263	476, 520, 703	91547-TZ5-A02	22588	673, 706	91626-SH3-003	19741	700
90676-SA7-003	17058	699	91505-S9A-003	20986	554, 576, 711	91548-TZ5-A02	22599	671, 702	91626-STK-A01	22547	670, 702
90676-SR4-003	18115	702	91505-T5A-003	25268	717	91550-S50-000ZK	21477	537, 577, 712	94109-14000	16956	306
90677-671-003	14687	715	91505-TM8-003	21706	555, 578, 675, 712	91550-S50-000ZL	21190	537, 577, 712	94109-2000	24319	306
90677-693-003	14687	715	91505-TY2-003	22703	567, 580, 715	91550-SH3-003	19142	533, 573, 713	95550-07000	25330	677, 716
90682-SB0-003	17058	699	91506-S9A-003	21173	556, 577, 675, 712	91550-SH3-003ZR	19142	533, 573, 713	95551-11000	25331	846
90682-SDA-A01	21205	701	91507-SH3-003	17632	542, 572, 638, 726, 766	91558-SE3-003	21388	677, 715	95551-15000	25332	847
90682-SEA-003	20954	670, 701	91508-S50-003	19547	538, 573, 710	91560-S04-003	22243	481, 706	95551-20000	25070	716
90683-693-000	14690	700, 792	91508-SM4-003	17192	543, 572, 711	91560-S0X-A01	21638	494, 518, 707	HYUNDAI		
90683-SA5-003	19311	533, 573, 713	91508-SR3-000	18165	538, 573, 711	91560-S6A-003	21206	496, 516, 707	11254-06203	22296	45, 62, 93, 105
90684-SA5-003	14696	531, 570, 713, 733, 798	91512-S50-003	21555	668, 695	91560-S7A-003	21554	495, 518, 706	11254-06206	22296	45, 62, 93, 105
90685-SA5-003	14356	479, 510, 795	91512-SED-003	22514	706	91560-S84-A01	21149	492, 516, 707	12291-06303	22757	64, 67, 86, 99
90687-671-003	14319	479, 510, 705	91512-SJ6-J01	21559	668, 694	91560-S84-A11	20411	495, 515, 673, 706	12493-05167B	18340	43, 54, 91, 99
90687-671-003	14319	479, 510, 705	91512-SJK-003	22069	554, 578, 675, 712	91560-S9A-A01	20959	495, 516, 674, 707	12493-05167-B	18340	43, 54, 91, 99
90687-SA5-003	14282	475, 510, 703	91512-SM4-003	17379	551, 572, 714	91560-SL4-003	20610	499, 515, 708	12493-06207-B	22295	45, 61, 105
90687-SA5-0030	14282	475, 510, 703	91512-SR3-004	20472	110, 671, 702	91560-SLJ-J01	21208	494, 516, 674, 707	12493-06257-E	25409	44, 56, 92, 100
90687-SB0-003	17287	528, 572, 713	91512-STK-A01	22112	554, 578, 675, 712	91560-SM4-003	20610	499, 515, 708	14160-03103	22437	348
90687-SB0-013	17287	528, 572, 713	91512-SX0-003	19239	552, 580, 606, 675, 711, 756, 785, 844	91560-SPO-003	19145	495, 513, 673, 706	14160-03130	25251	350
90688-SB0-003	14698	542, 570, 714	91512-TZ5-A01	22821	487, 673, 696	91560-SZW-003	21675	494, 518, 707	14160-03133	22481	349
90688-SB0-013	14698	542, 570, 714	91513-SE0-003	18818	473, 512, 709	91560-SZX-J01	21676	495, 518, 707	14160-05130	22436	353
90700-SB2-003	15998	464, 511, 704	91513-SJK-003	22068	384, 554, 578, 675, 712	91560-TX4-A01	22499	502, 521, 674, 708	14202-14120-B	25422	720
90713-SB0-003	14705	698	91513-SM4-000	17096	697	91561-S5P-A01	25256	670, 701	14206-08250-B	22253	543, 579, 726, 739
90820-SNA-003	25068	677, 716	91513-SMG-E01	22241	693	91561-S84-A00-MI	20352	537, 575, 713	14910-04000	22564	721, 736
90825-T2A-003	25327	677, 716	91513-SMG-E11	21207	693	91561-S84-A01	19415	697, 575, 713	14910-05000	21150	721
90853-SJA-A00	22995	355	91513-T0A-A01	22463	694	91561-S84-A21ZB	20352	537, 575, 713	14913-05010	21150	721
90866-SA0-000	20350	699	91514-SAA-003	22283	695	91561-SJD-003	21141	543, 577, 708	14913-05010	21150	721
91213-SZA-A01	22467	693	91514-SLN-A01	22434	549, 714	91561-TA0-A11	22394	543, 579, 675, 713	14913-05010	21150	721
91500-SM4-999AH	16960	64, 67	91514-SMG-E01	22433	669, 696	91561-TA5-A11	22394	543, 579, 675, 713	18642-21010	B9004	291
91501-S04-003	19118	551, 573, 711	91514-SYP-003	22468	695	91561-TL0-G21	22545	501, 521, 708, 803	18644-28087-L	B2357A	290
91501-S1K-003	20609	466, 515, 673, 704	91514-TF0-003	22482	579, 714	91561-TRT-J01	25269	496, 674, 708	18647-27009	B881	291
91501-SEA-003	20882	476, 516, 703	91514-TR3-A01	22367	531, 579, 714	91561-TX4-A01	22499	502, 521, 674, 708	18647-55007L	BH7	292
91501-SM4-003	17205	478, 511, 705	91516-SK7-013	17350	556, 572, 714, 801	91561-TG1-T01	22544	501, 521, 708	18647-55009E	BH1	292
91501-SNA-003	22054	476, 703	91516-SM4-013	19116	472, 513, 710	91561-TL0-G21	22545	501, 521, 708, 803	18649-55009	B9006	292
91501-STK-003	20609	466, 515, 673, 704	91518-S10-003	19682	477, 513, 705	91561-S84-A01	19415	697, 575, 713	18649-60556	18661	288
91501-SWA-003	21652	466, 518, 704	91518-SM4-003	19114	477, 512, 672, 705	91561-S84-A21ZB	20352	537, 575, 713	18649-60556-L	18661	288
91501-T2A-003	25069	673, 706	91519-S5A-003	20387	698	91561-S5P-A01	25256	670, 701	18649-65559	B9005	291
91501-TR0-003	21651	551, 578, 711	91519-SCV-A01	21597	697	91561-S84-A00-MI	20352	537, 575, 713	18649-65559	B9007	292
91502-S84-A01	19683	472, 514, 710	91520-S5A-003	20386	698	91561-S84-A01	19415	697, 575, 713	21512-23001	21135	317
91502-S84-A11	19683	472, 514, 710	91520-SCC-003	21295	473, 517, 794	91561-S84-A21ZB	20352	537, 575, 713	21513-21000	19007	309
91502-S9A-003	21216	696	91520-SM4-C01	18114	477, 511, 672, 705	91561-SJD-003	21141	543, 577, 708	21513-23001	19621	306
91502-SM4-000	17143	560, 572, 715	91524-SE0-003	17081	542, 572, 714	91561-TA0-A11	22394	543, 579, 675, 713	21513-23001	23442	118
91502-SM4-000	19407	560, 573, 715	91527-SM4-003	19415	697	91561-TA5-A11	22394	543, 579, 675, 713	21513-23001	23442	118
91502-SPO-003	18119	559, 573, 715	91527-SZ3-003	19415	697	91561-TV1-E11	22704	697	45285-3B010	25048	322
91502-TZ5-A01	21421	464, 517, 812	91528-S01-A01	19115	699	91562-S84-A01	23901	696	45286-3B010	25047	322
91503-S3Y-003	21419	695	91528-SR4-003	19115	699	91563-SCV-003	21707	471, 518, 671, 709, 834	81126-37010	20543	479, 515, 724, 737
91503-S7A-003	21297	552, 577, 711	91528-SS0-003	18866	697	91563-TG7-A00	22541	478, 521, 672	81174-21010	22507	727, 740
91503-SPO-003	17267	556, 572, 676	91530-S0A-003	21773	471, 518, 671, 709	91566-SP0-003	18294	502, 512, 708	81174-2L000	22506	727, 740
			91530-SE0-003	14328	510, 709	91567-SP0-003	18294	502, 512, 708	81199-33000	25199	727, 740
			91530-SH4-003	14328	510, 709	91567-SR2-013	21548	449, 518, 752, 834	81199-38000	25198	727, 740
						91568-SR2-003	19171	471, 513, 710	82132-27100	22337	472, 521, 724
						91568-TA0-A00	25066	669, 699	82133-37000	22526	468, 521, 723
						91568-TA5-003	21552	469, 699	82134-22000	22558	723
						91568-TR0-003	21705	471, 518, 671, 709	82134-31000	22591	723
						91570-SDA-A01	21095	697	82315-22000	22004	498, 519, 725
						91570-SK7-003ZF	19546	538, 573, 713	82315-2P000	21070	494, 516, 725, 738
									82315-2P000	22003	496, 519, 725, 738
									82315-2W000	22313	492, 520, 725, 738
									82315-33020	22005	495, 519, 726, 739
									82315-36000	22006	501, 519, 725

O.E.M. INTERCHANGE BY MANUFACTURER

OEM No.	Auveco No.	Page No.	OEM No.	Auveco No.	Page No.	OEM No.	Auveco No.	Page No.	OEM No.	Auveco No.	Page No.
82315-38000	21070	494, 516, 725, 738	87756-38000	20567	718, 736	0G032-50037-A	21146	542, 577, 739	87716-2W000	22470	719, 735
83219-22000	22135	721	87756-3D000	20566	722	0K95A-68401	22312	494, 520, 738	87719-02500	22014	735
84145-26000	22352	727	87756-3N100	22500	719	0K95A-68615	21372	740	87756-1C000	21356	722
84219-31000	22435	727, 739	87756-D3000	22327	720	12493-05167B	18340	43, 54, 91, 99	87756-1F000	22015	719, 735
84747-2L000	22007	718, 734, 384	87758-25000	22328	720	12493-06207-B	22295	45, 61, 105	87756-2G000	21312	718
85495-2E050	22008	491, 519, 726, 738	87758-35000	21064	718, 734, 782	12493-06257-E	25409	44, 56, 92, 100	87756-2J000	22508	722
85506-4A000	22009	497, 519, 725, 738	87758-35010	21863	722, 736	14160-03103	22437	348	87756-2W000	22325	471, 521, 724, 737
85815-24100	22314	719	87758-37000	21066	722, 736	14160-03130	25251	350	87756-34520	22017	722, 736
85818-37000	22592	725, 738	87758-38000	22329	718, 735	14160-03133	22481	349	87756-3E500	21484	735
85849-3B000	21360	496, 517, 725	87758-39000	22019	719	14160-05130	22436	353	87756-C5000	22326	735
85849-3L000	22315	500, 521, 726, 739	87758-3D000	20568	719	14160-05130	22436	353	87758-35010	21863	718, 734, 782
85858-3S000	22316	718, 734	87758-3L000	21321	720	14202-14120-B	25422	720	87758-38000	22329	718, 735
85859-3S100	22317	718, 734	87758-G2000	25423	719, 720	14206-08250-B	22253	543, 579, 726, 739	87758-3E000	22014	735
86143-3S000	22590	721	87759-27000	21292	723	14910-04000	22564	721, 736	87758-G2000	25423	719, 720
86155-22000	17162	532, 572, 601, 841	87759-2M000	22330	720	14913-05000	21150	721	87759-3E000	22014	735
86155-2H100	21328	531, 577, 726	87759-3S000	22297	723	14913-05010	21150	721	87759-3V000	22331	719, 735
86157-37000	21233	525, 577, 726	87759-3V000	22331	719, 735	18647-27009	B881	291	87767-J9000	25423	719, 720
86179-2V000	22318	724	87767-B1000	22938	720	18647-55007L	BH7	292	92485-2H000	22370	724, 737
86179-2V020	22319	724, 737	87767-J9000	25423	719, 720	18647-55009E	BH1	292	LAND ROVER		
86434-4A000	21382	468, 517, 724, 737	87770-27000	22020	719	18649-55009	B9006	292			
86438-1R000	22320	468, 521, 724	92155-22000	22296	45, 62, 93, 105	21512-23001	21135	317	DCE100560	22485	741
86438-2B000	18692	471, 512, 763, 834	92351-37000	21069	64, 72, 736	43114-4Y000	24317	306	DKP5279L	22093	487, 520, 742
86438-2T000	22321	468, 521, 724, 737	92485-2H000	21069	64, 72, 736	45285-3B010	25048	322	DYC000091	22151	741
86438-4A100	21381	468, 517, 724, 737	92552-36000	22006	501, 519, 725	45286-3B010	25047	322	DYC000122	22145	741
86450-36000	10577	117	97519-22000	22557	519, 725	81174-21010	22507	727, 740	DYC101420	21657	741
86518-3M000	22322	721, 736	INFINITI (SEE NISSAN)			81199-33000	25199	727, 740	DYC500010	25334	481, 523, 742
86590-1W000	22595	541, 579, 739, 814	ISUZU			81199-38000	25198	727, 740	DYF500010	25270	743
86590-28000	17632	542, 572, 638, 726, 766	14090908	24343	302	82134-22000	22558	723	DYH500131	22249	741
86590-28000-HZ	17632	542, 572, 638, 726, 766	8-03536-966-0	18665	303	82134-31000	22591	723	DYQ500060	22248	548, 579, 743
86590-35000	22299	560, 579, 739	8-11519-408-0	21047	314	82315-27000	21188	492, 516, 726, 738	DYR500010	25149	742
86590-3S000	21530	541, 577, 726, 739, 814	8-11562-588-0	21047	314	82315-2P000	22003	496, 519, 725, 738	IPN500050	22156	496, 520, 743
86591-25000	21363	736	894-133-167-0	23807	522, 733	82315-2W000	22313	492, 520, 725, 738	LR000080	22148	742
86593-24000	21067	727	8-94134-027-0	14739	733, 825	82315-33020	22005	495, 519, 726, 739	LR002229	22150	742
86595-2T500	17632	542, 572, 638, 726, 766	8-94145-515-0	17076	459, 511, 733	84145-26000	22352	727	LR012844	22245	508, 520, 742
86595-2T500	22253	543, 579, 726, 739	8-94218-027-0	17195	630, 782	84219-3L000	22435	727, 739	LR013135	22251	485, 520, 743
86625-1E000	22011	723	8-94221-150-0	14727	569, 571, 733, 801	84747-2L000	22007	718, 734, 384	LR018173	25424	741
86625-1E000	22562	723, 736	8-94226-492-0	14269	498, 510, 733, 764, 838	85495-2E050	22008	491, 519, 726, 738	LR027255	22149	502, 520, 743
86625-3S000	22011	723	8942-431-900	14369	550, 570, 767	85506-4A000	22009	497, 519, 725, 738	LR028939	22152	492, 520, 743
86699-1E010	22563	722, 723	894-298-119-0	14696	531, 570, 713, 733, 798	85746-06000-LX	21349	453, 517, 737	LR032984	22153	481, 520, 742
86699-2D000	21371	736	8-94328-493-2	14727	569, 571, 733, 801	85746-06000-RU	21350	453, 517, 737	LR033144	22155	528, 579, 743
86699-2M000	21371	736	8-94467-458-4	17355	437, 733	85818-37000	22592	725, 738	LR034389	22244	487, 520, 743
86825-26000	22505	726, 740	8-97134-978-0	17355	437, 733	85849-3L000	22315	500, 521, 726, 739	LR045194	25425	743
86825-28000	21378	115, 727, 740	8-97214-872-0	18661	288	85858-3S000	22316	718, 734	LR053837	22244	487, 520, 743
86848-22000	21068	721	8-97286-997-0	18897	288	85859-3S100	22317	718, 734	MWC3136	22085	741
86848-25000	21068	721	JAGUAR			86155-2H100	21328	531, 577, 726	RH500840	25426	742
86848-3W000	21068	721	C2C14628	22250	505, 520, 734	86179-2V020	22319	724, 737	RYQ500070	14753	540, 571, 601, 638, 656, 548, 579, 743
86848-C8000	21068	721	C2D5807	22157	497, 520, 734	86359-33500	21457	735	RYQ500170	22248	548, 579, 743
86910-21010	21232	723	C2S13233	19244	564, 573, 642	86438-2T000	22321	468, 521, 724, 737	XZQ000011	BH7	292
86910-22000	19505	827	C2S9354	14753	540, 571, 601, 638, 656	86438-4A100	21381	468, 517, 724, 737	LEXUS		
87378-3N000	22012	504, 519	C2Z11575	22247	734	86518-3M000	22322	721, 736			
87701-3B000	22324	722	C2Z11576	22246	734	86590-1W000	22595	541, 579, 739, 814	00234-00192	B168	290
87702-H1000	21244	720	XR819630	20363	532, 575, 643	86590-3S000	21530	541, 577, 726, 739, 814	00234-00194	16902	286
87703-H1000	22013	720	XR821729	20363	532, 575, 643	86591-25000	21363	736	35178-30010	24304	309
87714-FD200	21356	722	XR831159	22256	563, 579, 734	86593-24000	21067	727	35178-50010	24305	309
87715-3K000	22438	718, 737	XR87508	20233	563, 575, 639	86595-2T500	22253	543, 579, 726, 739	47749-06010	21357	749
87715-3S000	22565	721	KIA			86625-1E000	22562	723, 736	47749-50090	21357	749
87715-3V000	22561	721	K99564-1800	24317	306	86625-1M000	22323	721, 736	51453-0E010	21860	561, 578, 757, 845
87716-2W000	22470	719, 735	KKY01-50-715	23818	613, 630, 768, 817	86625-1M000	22323	721, 736	51454-0E010	21856	553, 578, 756, 844
87719-3D000	21038	718	MBF82-50-233	16843	569, 572, 768, 801	86699-2D000	21371	736	51454-48010	21856	553, 578, 756, 844
87756-1F000	22015	719, 735	MG350-68ABI	18824	491, 512, 764	86699-2M000	21371	736	51787-60070	22479	745
87756-26900	22016	722	MNA01-56145	16858	557, 572, 639, 739, 767, 800	86825-26000	22505	726, 740	52197-22020	22096	748, 828
87756-2E000	21136	720				86848-C8000	21068	721	52197-30040	21682	748
87756-2J000	22508	722				86899-2T500	25333	736	52599-0E010	21084	748
87756-2W000	22325	471, 521, 724, 737				87382-2W000	22366	735	53145-60030	22212	475, 520, 751, 831
87756-34520	22017	722, 736				87715-3K000	22438	718, 737	53259-0E010	21525	547, 577, 756
87756-37000	22018	720							53271-0B010	22102	748, 817

O.E.M. INTERCHANGE BY MANUFACTURER

OEM No.	Auveco No.	Page No.	OEM No.	Auveco No.	Page No.	OEM No.	Auveco No.	Page No.	OEM No.	Auveco No.	Page No.
KD53-51-W24	22512	486, 521, 764	000-990-32-62	25057	114, 780	002-988-05-42	25038	777	07-13-0-702-715	20570	717, 110
L206-56-652A	25073	788	000-990-34-92	20187	525, 573, 775, 857	002-988-51-81	20897	770	07-13-0-702-966	17267	556, 572, 676
L33X-13-209	21192	553, 800	000-990-37-92	20314	528, 575, 775	002-990-53-50	22780	689, 778	07-13-1-480-419	21709	780
LA01-51-958	25074	762	000-990-40-92	20640	527, 575, 775	002-997-33-86	18302	450, 512, 672, 703	07-13-2-757-821	21659	780
LA01-56-135	14750	113, 848	000-990-44-92	20639	527, 575, 775	002-997-33-86-67	18302	450, 512, 672, 703	07-13-7-073-915	21527	780
N304-13-356A	14697	529, 765	000-990-54-92	20234	533, 575, 685, 775	002-998-16-50	25081	778	07-14-6-974-274	22786	681
N304-13-356B	14697	529, 765	000-990-54-92-905120234	557	533, 575, 685, 775	002-998-17-01	25040	772, 773	07-14-7-265-039	22952	681, 780
NA01-56-145	16858	557	000-991-01-98	22309	494, 520, 775	003-988-41-78	20188	505, 514, 773	51-12-7-046-911	22788	688
NE51-51-SJ3A	21678	484, 518, 764	000-991-21-95	25058	569, 580, 778	003-990-02-51	21431	688, 778	51-13-7-034-022	25402	780
S47P-64-345	22483	758, 768	000-991-24-98	22899	486, 522, 774	003-990-24-97	21184	353	51-13-7-034-022	25402	780
S51S-51-833	21662	525, 578, 765	000-991-28-95	22900	451, 522	003-990-35-97	22122	356	51-14-8-209-932	22790	682
TD11-56-694	21661	453, 518, 763	000-991-39-40	25216	555, 580, 777	003-990-94-97	20971	351	51-16-8-197-908	22303	527, 579, 685, 781
TD12-51-SJ3A	21412	486, 517, 765	000-991-41-40	22901	776	003-994-30-45	13218	112, 690, 779	51-41-0-407-984	21788	500, 518, 684, 781
UB39-45-919	20465	575, 766	000-991-43-71	25116	770	003-994-75-45	22951	772	51-41-8-224-768	21788	500, 518, 684, 781
UB39-50-795	19747	541, 573, 766	000-991-44-71	25039	770	004-988-76-78	20657	770	51-43-7-001-491	21138	498, 516, 781
ZZLO-10-403A	24344	302	000-991-47-95	25059	773	004-988-77-78	20657	770	51-48-8-126-849	22524	681
ZZM1-51-472	B9007	292	000-991-49-40	22306	552, 579, 776	004-990-16-97	21286	358	51-71-1-496-621	21143	469, 516, 780
0000-11-0H1	BH1	292	000-991-52-40	14992	534, 637, 655	006-988-43-78	22236	482, 520, 774	51-77-7-171-002	21787	486, 518, 683, 781
0000-11-0H7	BH7	292	000-991-59-32	22265	358	007-603-006-106	23911	118	MITSUBISHI		
0000-11-9004	B9004	291	000-991-59-40	21711	526, 578, 775	007-603-010-103	23914	118	AB009005	B9005	291
0000-11-9005	B9005	291	000-991-63-98	22252	482, 520, 774	007-603-010-107	23915	118	AB009006	16898	288
0000-11-9006	B9006	292	000-991-63-98-64	22252	482, 520, 774	007-603-012-104	23926	118	AB009006	B9006	292
0000-11-H11	BH11	292	000-991-63-98-M2	22252	482, 520, 774	007-603-012-106	24330	306	HB121467	14720	479, 510, 783
1395-68-676-00	14369	550, 570, 767	000-991-71-71	20253	506, 514, 684, 775	007-603-014-100	23927	118	MB023930	14366	761, 790
9924-90-512B	14367	449, 510, 762	000-991-72-98	22922	771	007-603-014-102	23918	118	MB029111	14277	825
9926-40-531B	18271	475, 512, 763	000-991-74-98	22254	479, 520, 773	007-603-014-104	19621	306	MB098145	14275	783, 790, 827
9926-40-543	14349	474, 510, 763, 794	000-991-86-98	25215	493, 523, 774	007-603-014-106	20454	307	MB106212	14335	782, 790
9926-50-625	14260	532, 570, 599, 766, 841	000-99189-98	25032	493, 522, 773	007-603-016-102	23928	118	MB132008	14335	782, 790
9926-50-635	14369	550, 570, 767	000-99190-98	22902	770	007-603-016-105	14871	118	MB153825	17195	630, 651, 692, 733, 782
9927-40-821	14363	505, 510, 765	000-991-90-98	22902	770	007-603-018-101	23919	118	MB253964	17351	538, 572, 785
9927-40-822	16778	505, 511, 765, 835	000-991-92-40	25335	532, 580, 776	007-603-020-100	23929	118	MB325299	16671	847
9927-40-825	14269	498, 510, 733, 764, 838	000-991-92-40	25335	532, 580, 776	007-603-020-101	23910	118	MB358818	15926	211
9927-80-404	14365	768	000-994-04-45	13224	111, 779	007-603-020-102	23930	118	MB358819	15927	211
9927-80-405	14359	768	000-994-04-45	23852	111, 689	007-988-34-78	20879	496, 516, 774	MB361578	25428	783
9928-90-753	14376	298, 768	000-994-06-45	13218	112, 690, 779	008-988-09-78	22498	521, 683	MB475404	17162	532, 572, 601, 841
9928-91-053	14298	299, 716, 769	000-994-09-45	13220	115, 779, 805, 863	009-988-03-78	22504	773	MB547806	17472	557, 572, 785, 801
9956-41-400	19621	306	000-994-14-45	13215	690, 779	009-997-36-81	25030	771	MB566720	19334	485, 513, 784
9956-41-400	23442	118	000-994-14-45	13215	690, 779	011-988-76-78	22309	494, 520, 775	MB608104	19129	504, 513, 839
9956-41-800	24317	306	000-994-14-45	13216	112, 690, 779	012-988-50-78	25082	771	MB608104	19330	782
9957-83-000	25114	762	000-994-14-45	13216	112, 690, 779	111-997-03-30	18026	318	MB655630	22082	477, 519, 783
9991-00-402	14366	761, 790	000-994-14-45	13216	112, 690, 779	111-997-03-30-64	18026	318	MB696120	19320	481, 513, 784
9991-00-412	13930	761, 789	000-994-25-45	13223	111, 690, 779	114-997-02-90	20655	299, 779	MB608104	19129	504, 513, 839
9991-00-503	14313	700, 761, 789	000-997-01-33	22905	485, 522, 774	123-990-00-92	20636	527, 575, 776	MB608140	19330	782
9991-00-601	14274	700, 761, 789, 824	000-998-36-85	25427	772	123-990-02-92	20637	551, 575, 776	MB619582	21140	532, 576, 785
9CF6-00-516B	22294	44, 56, 92, 100	001-988-03-25	21105	479, 516, 773	124-988-90-78	22115	779	MB655630	22082	477, 519, 783
9GG6-00-616T	22293	80, 83	001-988-20-81	20205	772	124-990-04-92	20909	537, 576, 776	MB696120	19320	481, 513, 784
9XG0-75-93X0	20190	503, 514	001-988-76-81	20205	772	124-990-05-92-905120640	20640	527, 575, 775	MB814419	19314	782
9XG1-10-37X0	20190	503, 514	001-988-97-81	22310	469, 520, 773	124-990-07-92	20203	568, 575, 777	MB869072	19331	475, 513, 783
MERCEDES-BENZ											
000000-001606	BH11	292	001-990-01-92	22339	567, 579, 777	126-994-13-45	13215	112, 690, 779	MB879499	22077	541, 578, 785
000000-002111	B3457A	290	001-990-16-92	19195	536, 573, 858	201-990-00-50	20645	778	MB887567	17351	538, 572, 785
000000-004145	B921	290	001-990-16-92-64	25222	558, 580, 777	201-990-02-92	20638	559, 575, 686, 777	MC440901	20381	476, 515, 703, 783, 795
000000-008090	BH7	292	001-990-22-92	22920	527, 580	201-990-05-36	21774	44, 56, 92, 100	MD050317	19007	309
000000-008789	24263	316	001-991-02-71	25037	770	201-990-07-92	20203	568, 575, 777	MD145018	24289	331
000908-014009	24263	316	001-991-03-71	25060	771	201-990-07-92-9C7520203	20203	568, 575, 777	MD400250	24281	330
000-988-15-81	13141	772	001-991-26-98	22305	494, 520, 774	201-990-07-92	20203	568, 575, 777	MF453091	21746	44, 56, 92, 100
000-988-16-25	20647	772	001-991-34-71	25336	770	201-997-22-81	20659	772	MRI38807	18951	559, 573, 786
000-988-16-25	23228	681, 772	001-991-39-70	25035	112, 779	205-991-00-71	25034	770	MR200300	20247	542, 575, 711, 785
000-988-76-81	13141	772	001-991-41-98	22948	493, 522, 774	209-690-00-18	22949	771	MR221507	21623	782, 817
000-990-03-92	13230	524, 570, 775, 863	001-991-41-98	22948	493, 522, 774	211-988-05-78	25344	771	MR280579	25428	783
000-990-22-92	13230	524, 570, 775, 863	001-991-57-98	22950	492, 522, 776	230-990-00-92-9051	25031	559, 580, 687	MR288150	21658	531, 578, 785, 813
000-990-29-92	19195	536, 573, 858	001-991-76-70	21818	861	230-990-00-92-9C75	25214	580, 580, 777	MR322000	21690	485, 518, 784
000-990-31-62	25080	778	001-991-77-71	25061	771	400809-000007-64	BH7	292	MR328954	19274	551, 573, 800
MINI COOPER											
			001-997-42-90	20654	299, 778	463-988-02-78	20735	505, 515, 773	MR380850	25347	472, 523, 784
			002-990-20-17	24266	312	601-997-02-30	18026	318	MR435918	20571	481, 515, 784
						639-998-01-85	20647	772	MR478262	20580	532, 575, 657, 785
						639-998-01-85	23228	681, 772			
						07-13-0-702-516	21137	491, 516, 781			

O.E.M. INTERCHANGE BY MANUFACTURER

OEM No.	Auveco No.	Page No.	OEM No.	Auveco No.	Page No.	OEM No.	Auveco No.	Page No.	OEM No.	Auveco No.	Page No.
MR478263	20581	651, 783	01451-00891	20455	44, 57, 92, 102	01553-09311	19684	472, 514, 798	62380-U7400	17196	792
MR489986	22361	484, 521, 783	01454-N5061	22292	44, 58, 92, 102	01553-09321	19274	551, 573, 800	62660-48600-1	20381	476
MR975267	22484	498, 521, 764, 784	01466-00261	25258	59, 92, 103	01553-09431	21134	555, 576, 800	62698-V7000	14313	700, 761, 789
MS452348	21744	44, 58, 92, 103	01552-00661	21999	802	01553-09611	20349	542, 575, 755, 799, 842	62828-AG000	22762	566, 580, 801
MS480001	14255	699, 761, 782	01553 00542	23700	494, 522, 797	01553-09791	20668	496, 515, 730, 797	62869-N4700	14723	478, 510, 795
MS480002	13932	782, 824	01553-00042	23700	494, 522, 797	01553-10051	19905	550, 573, 800	63844-01A00	16858	557, 572, 639, 739, 767, 800
MS480003	23971	650	01553-00051	14356	479, 510, 795	01553-10481	22832	502, 731, 797	63844-01A99	14726	538, 571, 799
MS480009	13932	782, 824	01553-00172	14737	475, 510, 795, 831	01553-10501	20349	542, 575, 755, 799, 842	63844-D0100	14727	569, 571, 733, 801
MS480012	14695	700, 761, 782, 790, 826	01553-00202	14347	478, 510, 795, 832	01553-10611	23989	498, 522, 731, 797	63846-5V000	21768	729, 791
MS661162	24289	331	01553-00291	14355	474, 510, 794	01553-10641	22288	502, 520, 731	63846-9E000	20813	793
MS820083	B9005	291	01553-0034U	17350	556, 572, 714, 801	01553-10721	21192	553, 577, 731, 767, 800	63848-01G00	16782	555, 572, 713, 799
MS820961	BH1	292	01553-0038U	21311	542, 577, 799	01553-10721	21229	471, 516, 730, 794	63848-35F00	19735	113, 804
MS820964	BH3	292	01553-00401	14355	474, 510, 794	01553-1JA0A	22039	553, 578, 731, 799	63848-40Y00	20613	545, 575, 799
MS820970	B9004	291	01553-0052U	20671	476, 515, 795	01553-2DR9A	22039	553, 578, 731, 799	63848-5HA0A	19735	113, 804
MS820978	BH11	292	01553-00541	23737	474, 522, 794	01553-2U001	21824	729, 791	63848-9E001	20327	546, 575, 799
MS820978	BH13	292	01553-00542	23700	494, 522, 797	01553-30001	22237	496, 520, 797	63848-9Y000	21664	732, 804
MS820979	BH7	292	01553-00545	17452	475, 511, 795	01553-S3500	13945	506, 509, 798	63848-AQ100	22764	499, 522, 797
MU0000319	19239	552, 580, 606, 675, 711, 756, 785, 844	01553-00755	16784	542, 572, 799, 842	01553-S3500A	13945	506, 509, 798	63848-D0100	17193	114, 804
MU000573	22513	484, 521, 784	01553-0075U	18948	451, 512, 795	01651-00481	14695	700, 761, 782, 790, 826	63848-D4000	17385	114, 804
MU000695	25206	562, 580, 660, 785	01553-01121	17452	475, 511, 795	01651-00491	22831	791	63848-D4001	17385	114, 804
MU000977	22462	482, 521, 784	01553-01182	20256	452, 514, 796	01658-01361	22761	802	63854-01A00	17472	557, 572, 785, 801
MU001220	25206	562, 580, 660	01553-01393	16843	569, 572, 768, 801	01658-02121	22820	803	63876-95596	16000	550, 571, 714, 767, 800
MU001282	22589	460, 521, 783	01553-0162U	22572	500, 521	01658-02133	22896	803	63878-01E10	20348	559, 575, 800
MU480034	19322	782	01553-0170U	22503	458, 521, 796	08540-61608	19170	44, 59, 92, 103	65624-V0100	14337	802
MU481027	19325	469, 513, 784	01553-01733	20196	529, 575, 840	10998-30880	14696	531, 570, 713, 733, 798	65625-8J000	22573	802
MU481187	19323	477, 513, 783	01553-01781	17634	450, 511, 794	11026-01M02	21258	309	65722-01E00	22358	732, 802
MU481283	19749	471, 514, 834	01553-01A50	21519	450, 517, 730, 795	11026-61000	24299	309	65722-50A00	22362	802
MU840004	15931	211	01553-02741	17378	561, 572, 801	11026-JA00A	21258	309	65722-EA000	21309	802
MU840015	15926	211	01553-02903	22063	483, 519, 730, 796	1128-01M0B	21293	313	65810-K2000	21229	471, 516, 730, 794
MU840016	15927	211	01553-02913	21621	790	1128-69220	15528	318	65810-K2002	22060	470, 519, 730, 794
MU840021	15931	211	01553-02923	21688	729, 792	1128-U8000	15528	318	65810-K2009	19724	473, 514, 798
106212	14335	782, 790	01553-03101	17378	561, 572, 801	11296-3TA0A	22198	804	65832-F5000	17237	466, 511, 796
			01553-03201	20753	562, 576, 801	11296-AG000	20953	553, 576, 731, 800	65846-30F00	17237	466, 511, 796
			01553-03269	15481	460, 510	24220-89986	14345	802	65846-40F00	19468	464, 513, 730
			01553-03803	19416	544, 573, 713, 766, 842	24225-89960	21259	300, 803	65846-4Z000	21288	464, 517, 796
			01553-03831	21121	786	26261-04W00	16902	286	66814-01G00	16725	568, 572, 801
			01553-05131	21637	732, 803	26261-04W00	16902	286	66820-3S500	20672	483, 515, 796
			01553-05233	22301	728, 786	26261-89917	18005	286	66820-3S500-CI	20672	483, 515, 796
			01553-05323	21192	553, 577, 731, 767, 800	26261-89917	18005	286	66820-3S510	20614	787
			01553-05751	16860	786	26261-89949	18005	286	66820-4BA5A	22476	788
			01553-05891	22760	458, 464, 521	26261-89962	B7440A	290	66820-61U00	21689	730, 793
			01553-05933	21192	553, 577, 731, 767, 800	26261-89965	B168	290	66820-9N00A	22128	793
			01553-06071	21620	533, 578, 799	26261-89969	B7443A	290	66820-AX020	21159	798
			01553-06451	22075	454, 519, 730, 796	26261-9B90A	20591	287	66824-01G00	16783	527, 572, 798
			01553-06721	17347	552, 572, 801	26261-9B90C	19206	287	66860-01W01	16859	530, 572, 600, 798
			01553-06753	25185	477, 523, 795	26261-9B91C	19206	287	68425-H5000	14313	700, 761, 789
			01553-07111	20669	499, 515, 731, 797	26261-9B91D	19206	287	72826-01P00	15468	788
			01553-08231	21545	556, 577, 732, 800	26261-9B91E	B7440	290	73858-AU100	22514	351
			01553-08911	21618	787	26261-9B91F	B3457A	290	73998-3TA0A	22574	787
			01553-08951	19724	473, 514, 798	26261-9B92B	B7440A	290	74798-S9000	14895	700, 761, 782, 790, 826
			01553-08961	21295	473, 517, 794	26261-9B92D	B7528	290	74816-AX000	22851	802
			01553-09001	20671	476, 515, 795	26299-9B90A	20591	287	74849-JD00A	22904	802
			01553-09131	22897	491, 522, 730, 787	26299-9B90B	20591	287	74849-JD00B	22919	803
			01553-09241	19246	544, 573, 799	26299-9B90C	19206	287	76847-JB0A	22055	787
						26299-9B90D	18661	288	76847-JG00A	22281	788
						26299-9B90E	B9007	292	76848-35F00	22261	728, 791
						26299-9B90F	BH13	292	76848-54C00	22059	792
						26299-9B90G	BH13	292	76848-5HA0A	22257	792
						26299-9B90H	B9005	291	76848-71S00	21622	792
						26299-9B90I	BH9	292	76848-ED000	22255	730, 793
						26299-9B90J	B9004	291	76848-JG00A	22257	792
						26299-9B90K	BH11	292			
						26398-ED000	21850	728, 793			
						26557-2U000	22440	792			
						26557-2U001	21824	729, 791			
						26717-9B917	B3457	290			
						27158-Q0100	17634	450, 511, 794			
						28945-CA000	22275	802			
						40224-21001	14253	129			
						40224-EJ20A	14253	129			
						54229-0201P	16340	436, 803			
						62228-51S00	19147	804			
						622A2-9E000	21361	564, 577, 609, 801			
						622A2-9E000A	21361	564, 577, 609, 801			
						62318-01W00	16860	786			
						62318-H8500	21121	786			
						62319-0W000	20266	789			
						62319-AU000	22287	729, 793			

MOTORCRAFT

WPT-1025	23061	244
WPT-118	20851	250
WPT-1277	25160	223, 249, 277
WPT-159	20842	248
WPT-169	20843	251
WPT-173	18671	251
WPT-335	20848	242

NISSAN

01241-0009U	22584	116, 151
01241-00551	17193	114, 804
01241-00881	21459	115, 732, 804
01241-01051	25092	115, 732, 804
01281-00023		

O.E.M. INTERCHANGE BY MANUFACTURER

OEM No.	Auveco No.	Page No.	OEM No.	Auveco No.	Page No.	OEM No.	Auveco No.	Page No.	OEM No.	Auveco No.	Page No.
09409-05309-5ES	23962	522, 816	53271-12040	22102	748, 817	67771-12050	15709	498, 511, 838	75545-89101	16942	823
09409-07303-5ES	19128	550, 573, 844	53271-12060	22102	748, 817	67771-12050	19257	499, 513, 754, 838	75546-12030	16821	823
09409-07308	17162	532, 572, 601, 841	53271-44010	20738	747, 817	67771-12050	19898	499, 514, 838	75546-12050	14746	823
09409-073085PK	17162	532, 572, 601, 841	53326-08010	21211	466, 516, 833	67771-12070	20473	484, 515, 753, 836	75546-12060	19204	823
09409-07313	17383	526, 572, 601, 816, 840	53384-0R010	22126	548, 579, 843	67771-12080	20575	496, 515, 753, 837	75546-14080	16821	823
09409-07332	20908	551, 576, 816, 844	53384-68010	22126	548, 579, 843	67771-14040	15707	499, 511, 839	75547-51021	21082	350
09409-08320	19257	513, 754, 838	53455-14020	14732	846	67771-16080	19108	499, 512, 839	75548-60021	22427	746, 823
09409-08327	22083	535, 578, 816	53455-33010	19529	846	67771-16120	18874	500, 512, 839	75791-0W010	15707	499, 511, 839
1151A-78J00	24265	315	53455-33011	19529	846	67771-16160	18874	500, 512, 839	75819-33010	21748	745
3500378J02	BH13	292	53857-0E010	22334	753	67771-16170	18875	484, 512, 836	75867-02010	21226	483
77259-71B00	20744	816	53857-12010	22346	744, 818	67771-16170	18875	484, 512, 836	75867-06030	21596	516, 835
77553-65D00	20743	816	53857-47011	22103	466, 520, 752, 832	67771-16210	14270	499, 510, 838	75867-21010	20576	481, 515, 835
77553-65D10	22079	816	53879-47020	21237	828	67771-22010	14270	499, 510, 838	75867-30110	19842	455, 514, 832
83942-65D00	22078	816	53879-02070	20758	749, 829	67771-22020	14728	497, 510, 837	75867-30120	21123	545, 576, 842
83943-86000	23961	522, 590, 816	53879-02150	22944	749, 829	67771-22020	14728	497, 510, 837	75867-30130	22056	483, 752, 835
TESLA			53879-02150	22944	749, 829	67771-26240	22486	754, 839	75867-33030	21538	483, 518, 835
1006521-00-A	20349	542, 575, 755, 799, 842	53879-06100	21797	749, 829	67771-30070	19109	494, 512, 836	75867-52020	22478	484, 521, 835
1006535-00-A	19453	574	53879-0R010	22412	829	67771-30090	19129	502, 513, 839	75867-68010	22571	484, 521, 835
1008245-00-A	25284	667	53879-14010	14750	113, 114, 147, 769, 848	67771-30090	23559	503, 522, 839	75867-AA010	21012	483, 516, 753, 836
1010919-00-A	19506	452, 513, 672, 704	53879-14010	19669	113, 114, 147	67771-32090	18844	497, 512, 837	75867-AA010	21538	483, 518, 835
1011813-00-A	20633	497, 515, 666, 838	53879-14010A	14750	113, 114, 147, 769, 848	67771-58010	21369	817	75867-AC020	21653	819
1011978-00-A	25285	359, 667	53879-14020	14750	113, 114, 147, 769, 848	67771-89104	19203	495, 513, 837	76519-60010	25430	748, 826
1016078-00-A	20765	515, 666	53879-14020	19669	113, 114, 147	67773-0E020	21795	487, 518, 753, 836	76817-68010	22454	745, 819
1025401-00-A	21169	503, 516, 544, 666, 667, 711	53879-17020	21359	113, 759, 848	67867-0C010	20443	471, 515, 834	76829-60020	25337	480, 523, 752, 835
1028719-00-A	17421	346, 359	53879-17020	21359	113, 759, 848	67867-0D060	21707	471, 518, 671, 709, 834	76853-10010	21586	822
1047307-00-A	21822	498, 519, 806, 838	53879-22010	14276	115, 849	67867-12150	19749	471, 514, 834	76879-44010	21611	847
1063943-00-A	25179	667	53879-22030	14750	113, 114, 147, 769, 848	67867-12150	19749	471, 514, 834	76923-47010	22072	568, 578, 757, 845
1067906-00-A	12119	110, 130, 667	53879-28010	22412	829	67867-28030	18692	471, 512, 763, 834	76923-52021	22502	567, 579, 757, 845
1092696-00-B	25151	666	53879-30040	21797	749, 829	67867-52010	21707	471, 518, 671, 709, 834	76924-02010	20578	588, 821
110713-99-C	25152	667	53879-30050	22489	749, 829	67867-52010	21707	471, 518, 671, 709, 834	76924-02020	20578	588, 821
1115346-00-A	25286	667	53879-33030	22944	749, 829	67867-89103	18692	471, 512, 763, 834	76924-12030	22166	829
1128034-00-B	25112	667	53879-33030	22944	749, 829	67867-89103	18692	471, 512, 763, 834	76924-13020	22457	821
1135147-00-A	25153	666	53879-50020	21358	749	67868-02020	19749	471, 514, 834	76924-12030	22166	829
1142766-00-A	25287	666	53879-58010	20758	749, 829	67868-02020	19749	471, 514, 834	76924-13020	22457	821
TOYOTA			53879-60010	20335	540, 575, 842	67868-30030	21627	449, 518, 751, 833	76924-47010	21217	822
SU003-02194	21326	318	53879-60010	20335	540, 575, 842	67868-30030	21627	449, 518, 751, 833	76924-47020	22073	479, 519, 749, 829
00234-01156	16904	286	53888-48010	21225	543, 577, 843	67868-89101	18692	471, 512, 763, 834	76924-52021	20578	588, 821
10116-41810	23738	530, 580, 841	53935-35020	21162	823	67868-89101	18692	471, 512, 763, 834	81124-89101	16951	817
12157-10010	21116	309	56115-30100	25345	746, 824	67869-12050	21551	479, 518, 834	81137-22530	21628	824
47749-06010	21357	749	61118-35010	21194	818	67869-20030	21548	449, 518, 752, 834	81496-0E020	22488	818
47749-06010	21357	749	61991-35010	21234	822	67869-22010	22357	834	81496-52020	22488	818
47749-08010	20757	749, 829	61992-35010	21235	822	67869-22030	21548	449, 518, 752, 834	81496-60010	22398	744, 818
47749-50090	21357	749	62217-13010	20558	492, 515, 753, 836	67921-32010	19719	482, 514, 835	82711-12200	21553	299, 847
47749-58010	20757	749, 829	62217-13010	20558	492, 515, 753, 836	67921-32010	19719	482, 514, 835	90075-10004	21628	824
51453-0E010	21860	561, 578, 757, 845	62217-33031	22158	822	69293-12030	20469	757, 846	90075-10801	19783	631, 747, 825
51453-48010	21860	561, 578, 757, 845	62217-42030	25413	824	69293-12040	20470	758, 846	90075-10805	19783	631, 747, 825
51454-0E010	21856	553, 578, 756, 844	62489-0E010	22460	754, 840	69293-12050	20534	758, 846	90075-60060	25291	276
51454-48010	21856	553, 578, 756, 844	62581-14020	16778	505, 511, 765, 835	69293-12050	20534	758, 846	90080-46010	21296	474, 517, 831
52115-0C090	21221	822	62955-12010	15695	818	69293-12060	20535	758, 846	90080-46269	19797	819
52115-48040	21132	822	62955-20020	15695	818	69293-12060	20535	758, 846	90080-46294	21325	537, 577, 842
52161-02020	18873	547, 573, 843	62955-50010	22456	745, 819	69293-30030	21336	758, 846	90080-46327	22221	476, 520, 832
52161-02030	18873	547, 573, 843	65487-60010	22497	750, 834	69293-33010	20469	757, 846	90080-81041	16897	288
52161-16010	18873	547, 573, 843	67771-01010	14144	499, 510, 838	69293-33020	20470	758, 846	90080-82014	12540	213
52161-20010	20931	547, 573, 843	67771-02030	15709	498, 511, 838	69293-33020	20470	758, 846	90080-82015	21436	213
52188-06030	22197	828	67771-02030	15709	498, 511, 838	69293-33020	20470	758, 846	90080-82052	21437	213
52197-22020	22096	748, 828	67771-02030	19898	499, 514, 838	69293-33020	20470	758, 846	90080-82053	21166	213
52197-30040	21682	748	67771-02030	19898	499, 514, 838	69293-33020	20470	758, 846	90080-82055	21438	213
52535-0E010	21015	748, 826	67771-03030	15707	499, 511, 839	69293-33020	20470	758, 846	90084-26001	17420	346
52535-0E030	21712	746, 821	67771-03030	15707	499, 511, 839	69293-33020	20470	758, 846	90084-26002	20383	351
52535-50060	21015	748, 826	67771-04040	19210	501, 513, 839	69293-33020	20470	758, 846	90084-26008	17411	346
52599-48020	22335	753	67771-06010	18844	497, 512, 837	69293-33020	20470	758, 846	90084-46020	21071	821
53145-12010	22163	818	67771-06010	18844	497, 512, 837	69293-33020	20470	758, 846	90084-98033	18661	288
53145-60030	22212	475, 520, 751, 831	67771-06030	19109	494, 512, 836	69293-33020	20470	758, 846	90099-14044	18136	423
53271-08010	22102	748, 817	67771-12010	14269	498, 510, 733, 764, 838	69293-33020	20470	758, 846	90099-14045	18143	423
			67771-12030	15709	498, 511, 838	69293-33020	20470	758, 846	90105-06037	21840	80, 83
			67771-12040	19016	500, 512, 839	69293-33020	20470	758, 846	90118-WB048	22424	555, 579, 767, 845
						69293-33020	20470	758, 846	90159-50316	21839	44, 58, 92, 101
						69293-33020	20470	758, 846	90159-60303	22106	45, 59, 92, 103
						69293-33020	20470	758, 846	90159-60488	21838	45, 60, 93, 105

O.E.M. INTERCHANGE BY MANUFACTURER

OEM No.	Auveco No.	Page No.	OEM No.	Auveco No.	Page No.	OEM No.	Auveco No.	Page No.	OEM No.	Auveco No.	Page No.
90159-60498	25078	45	90430-18023	24371	304	90467-07066-J0	17383	526	90467-08186-C3	20184	453
		61, 93, 105	90430-24003	25084	307		572, 601, 816	840		514	830
90159-60525	21837	45	90430-C0005	22134	310	90467-07071-22	21249	526	90467-08188	22369	750
		62, 93, 105	90467-10168	18950	497			577, 840			830
90159-A0001	21839	44			512, 837	90467-07072	14697	529	90467-08195	21847	745
		58, 92, 101	90467-04023	23945	113		570, 599, 713	765			820
90159-A0030	21838	45	90467-04032	22214	474	90467-07072-22	14697	529	90467-08196	21846	745
		60, 93, 105			520, 831		570, 599, 713	765			820
90183-03001	16306	847	90467-04034	21552	469	90467-07076	17162	532	90467-08217	19239	552
90189-04007	23729	825		518, 523, 752	834		572, 601, 841			580, 606	675
90189-04008	14277	825	90467-05020	19506	452	90467-07076-C0	17162	532		711, 756, 785	844
90189-04011	14271	824		513, 672, 704			572, 601, 841		90467-08224	22396	745
90189-04013	14268	700	90467-05020-01	19506	452	90467-07085	23943	541			819
		826		513, 672, 704				580, 842	90467-08225	22217	819
90189-04014	14256	824	90467-05045-22	19686	449	90467-07096	19124	478	90467-09004	19112	477
90189-04019	14263	826			514, 830		513, 832				512, 833
90189-04057	14271	824	90467-05063-C0	21218	525	90467-07121	19908	549	90467-09004-01	19112	477
90189-04066	14281	700			577, 840		573, 843				512, 833
		827	90467-05081	21615	114	90467-07121-B2	19907	549	90467-09006	18842	477
90189-04102	21544	747			759, 849		573, 843				512, 833
		825	90467-05090-B1	21103	525	90467-07121-B2	19908	549	90467-09008	14738	477
90189-04176	19840	825			576, 840		573, 843				510, 833
90189-04231	25431	747	90467-05096-22	19312	452	90467-07121-C0	19908	549	90467-09008-01	14738	477
		825		513, 830			573, 843				510, 833
90189-05012	14739	733	90467-05114	20956	114	90467-07126	19535	748	90467-09050	19729	476
		825		147, 759, 848				828			514, 751, 833
90189-05013	13932	782	90467-05125	21693	452	90467-07138	17992	552	90467-09051	25076	478
		824			518, 750			572			522, 751, 833
90189-05105	20431	825	90467-05128	21614	114	90467-07138-C0	17992	552	90467-09093	17439	535
90189-05105	23560	825			848			572			572, 754
90189-05142	21191	826	90467-05136	21849	528	90467-07146	19552	535	90467-09096	19219	535
90189-06001	14275	783		578, 754, 840			573, 841				573, 755, 845
		790, 827	90467-05138	21687	759	90467-07164	20908	551	90467-09127	19739	559
90189-06005	14273	748			848		576, 816, 844				573, 704, 845
		828	90467-05162-C0	25075	450	90467-07166	18888	550	90467-09139	19416	544
90189-06006	14265	826		522, 750, 830			573, 844				573, 713, 766, 842
90189-06010	14274	700	90467-05164	21332	517	90467-07168	20577	549	90467-09143	17988	548
		761, 789, 824			830		575, 599, 755, 843				572
90189-06013	14267	748	90467-05164-B6	21253	454	90467-07168-C1	20577	549	90467-09145	17206	532
		828			517, 830		575, 599, 755, 843				572, 841
90189-06018	14258	825	90467-05164-E2	21332	517	90467-07188	21011	534	90467-09166	21010	551
90189-06027	25432	747			830			576, 841			576, 844
		828	90467-05170	22125	524	90467-07190-B2	21104	529	90467-09169-C0	22395	751
90189-06028	19194	584		579, 754, 840			576, 840				832
		827	90467-06005	22472	846	90467-07192	21120	533	90467-09185	21547	542
90189-06029	19505	827	90467-06015-C0	22214	474			576, 841			577, 755, 842
90189-06042	14695	700			520, 831	90467-07193	23958	534	90467-09204	21546	744
		761, 782, 790, 826	90467-06017	14260	532			580, 841			817
90189-06065	20440	828		570, 599, 766, 841		90467-07195	23959	550	90467-09206	20437	496
90189-06066	25433	617	90467-06017-41	14260	532			580			515, 837
		651, 747, 826		570, 599, 766, 841		90467-07201	20955	756	90467-09212	21410	491
90189-06076	22213	827	90467-06017-C0	14260	532			844			517, 836
90189-06084	19505	827		570, 599, 766, 841		90467-07211	21201	547	90467-09227	21366	562
90189-06104	19742	747	90467-06128	21626	474			577, 756			577, 845
		827			518, 831	90467-07214	21294	550	90467-09232	22845	501
90189-06111	19783	631	90467-06133	20196	529			577, 844			754, 840
		747, 825			575, 840	90467-07215	22439	844	90467-09237	22353	749
90189-06114	20412	828	90467-06133-C0	20196	529	90467-07217	22400	755			829
90189-06116	19505	827			575, 840			843, 845	90467-09242	22568	562
90189-06145	21625	747	90467-06133-C0	23935	580	90467-07220	22567	553			579, 757
		827			840			579, 756	90467-10018	14347	478
90189-06157	19721	828	90467-06150	19490	540	90467-07222	25338	548			510, 795, 832
90189-06172	19505	827			573, 842			580, 756, 843	90467-10077	19797	819
90189-06177	21411	828	90467-06158-C0	25434	758	90467-08004	18297	474	90467-10107	19123	476
90189-06193	20895	825			849			512, 750, 831			513, 833
90189-06211	21331	826	90467-06161-01	14736	475	90467-08008	14737	475	90467-10146	19728	472
90189-06214	19756	827			510, 831			510, 795, 831			514, 834
90189-06228	20412	828	90467-06175	21560	454	90467-08011	18297	474	90467-10161	18876	498
90189-06236	21792	827			518, 763			512, 750, 831			512, 837
90189-06237	20895	825	90467-06183	25435	758	90467-08011-83	18297	474	90467-10162	18861	481
90189-06238	22566	826			848			512, 750, 831			512, 835
90189-09002	22939	826	90467-06192	22487	752	90467-08014	19121	458	90467-10167	20559	493
90189-A0002	20440	828			832, 833			513, 831			515, 753, 836
90189-A0002	21605	747	90467-06205-C0	22495	751	90467-08014-01	19121	458	90467-10168	18950	497
		827			532			513, 831			512, 837
90189-A0008	21625	747	90467-07041	17162	532	90467-08045	21695	474	90467-10170-C0	21702	543
		827			572, 601, 841			518, 831			578, 755, 843
90189-A0011	19742	747	90467-07041-B0	17162	532	90467-08063	21695	474	90467-10173	19123	476
		827			572, 601, 841			518, 831			513, 833
90269-03041	8905	339	90467-07041-B0	19162	147	90467-08081	18878	477	90467-10181	22351	744
90269-04047	21715	352	90467-07041-B2	17162	532			512, 833			818
90269-04053	20627	349			572, 601, 841	90467-08101	21643	475	90467-10183	20869	463
90269-05034	21713	354	90467-07041-C0	17162	532			518, 751, 831			516, 540, 576
90269-05035	17420	346			572, 601, 841	90467-08108	21643	475			604, 750, 755, 842
90269-05035	20626	355	90467-07042-C0	21560	454			518, 751, 831	90467-10186	21634	476
90269-05054	20626	355			18, 763	90467-08124	19113	476			518, 751, 832
90269-05056	21713	354	90467-07043	16784	542			512, 751, 833	90467-10188	20633	497
90269-06013	20834	355			542	90467-08136	21254	479			515, 838
90269-06017	21315	357	90467-07043-11	16784	542			517, 832	90467-10192	20558	492
90269-06054	21742	352			572, 799, 842	90467-08145	16000	550			515, 753, 836
90269-A0005	21315	357									

O.E.M. INTERCHANGE BY MANUFACTURER

OEM No.	Auveco No.	Page No.	OEM No.	Auveco No.	Page No.	OEM No.	Auveco No.	Page No.	OEM No.	Auveco No.	Page No.
90467-12075	21642	821	N013849-S	24232	332	165-827-592	21480	851	7L0-839-069	21512	850
90467-12078	16779	479	N-014-389-3	13173	850	171-201-969	21456	862	7L5-853-994	21495	482
	511, 705, 832				862	171-807-249-A	21494	505		517, 807, 856	
90467-12078-01	16779	479	N0160276	24263	316	175-820-435	16252	517, 856	7L6-868-243	21708	507
	511, 705, 832		N016185-7	5748	338	175-853-577	13748	341			518, 857
90467-12080	21549	744	N0385491	19195	536	175-853-577-01C	13748	341	7L6-868-307	21875	528
		817			573, 858	175-853-577A	13753	342		578, 806, 808	
90467-12096	14277	825	N-038-550-1	21391	527	175-867-299	13475	505	7M0-867-299-K	21853	485
90467-13005	17194	817			577, 858		509, 808, 856			519, 742, 855	
90467-13008	17194	817	N043815 2	23910	118	175-867-949	8418	72	7M3867299	21853	485
90467-13011	17195	630	N0438541	24302	309	179-813-881	14030	584		519, 742, 855	
	651, 692, 733, 782		N-102-563-01	B9007	292	179-813-883	12735	583	811-807-557-C	21510	851
90467-13075	21623	782	N-102-593-01	20187	525			649, 851	811-807-577-C	21510	851
		817		573, 775, 857					823-867-299	20252	505
90467-14053	22708	757	N-103-180-01	22826	852	191-853-577	21508	850	867-809-966	21510	851
		847	N-103-201-01	16897	288	191-941-142	21498	851	8D0-805-121	21889	859
90467-17004	17438	817	N10320102	16897	288	1H0-819-055-B-01C	21392	458	8E0-821-989-A	22824	850
90467-22014	22569	821	N-103-201-02	BH7	292			517, 854	8E0-837-485-D	25415	854
90467-22015	22570	821	N105-073-01	22720	852	1H0-837-719	21497	478	8E0-864-229-9B9	22444	860
90467-22017	25346	479	N-105-835-01-9B9	22830	528			517, 854	8E0-868-243	21144	507
	523, 749, 829				858			577, 859		516, 856	
90467-A0002-C0	22473	750	N-106-213-01	21988	852	1H0-853-585-B	21395	850	8K0-805-121	21887	859
		830	N-107-009-01	22421	531	1H0-867-199A	21482	563	8K0-805-922A	22260	861
90467-A0002-C4	22473	750			579, 858			577, 859	8K0-821-213A	22308	853
		830	N10724402	B7440	290	1H0-867-199-A	21482	577, 859	8K0-837-199	22719	851
90467-A0003	19113	476	N14-4003	11404	74	1H0-868-243-B	21415	517, 857	8K0-868-307	22420	536
	512, 751, 833				106			517, 857		579, 858	
90467-A0003	19729	476	N185101	11101	120	1H5-863-849-A01C	21145	857	8L3-837-199-B	22397	569
	514, 751, 833				326	1J0-827-713	22711	854		579, 858	
90467-A0004	22350	746	N185112	11099	120	1J6-867-276	22116	861	8R0-853-909	22414	850
		820			120	1K0-837-199-B	22397	569	8T0-853-909-A	22426	849
90467-A0005	20437	496	N185151	11097	120	1K0-837-200B	22231	491	8U0-853-909	22417	485
		515, 837	N185161	11098	120			520, 856	8V0-853-585	22823	849
90467-A0005	21102	497	N185301	11100	120	1K8-837-529	22713	430	8V0-868-243	22442	857
	516, 753, 838				326			851	8W0-805-121	21887	859
90467-A0006	18876	493	N900845-01	17006	352	357-827-998	20933	852	8Z0-857-784	21875	528
	512, 837		N-900-845-01	17006	352	357-853-575	21509	480		578, 806, 808	
90467-A0007	22471	752	N90100001	12595	109			517, 855			
90467-A0008	20878	458	N90100001	23684	109	357-853-585-A	21496	481	VOLVO		
	516, 750, 830		N-901-686-02	22113	116			855	11998	24317	306
90467-A0009	18297	474	N90168604	22113	116	3A0-853-575	21478	850	123996-0	24304	309
	512, 750, 831			149, 150, 690, 861	116	3AA-868-243-A	22827	857	1268176	19248	536
90467-A0016-C0	17162	532	N90-229-301	22095	561	3B0-839-723	25339	468			573, 863
	572, 601, 841				578, 859	3B0-867-333	25260	487	1268176-3	19248	536
90467-A0018	21615	114	N-902-889-01	21352	316	3B0-867-334	25414	853			573, 863
	759, 849		N90-335-006	21513	861	3B0-868-243	20341	507	15304-9	23918	118
90467-A0032	22455	752	N903591-01	20234	533			515, 856	18665-0	23915	118
90468-04030	16671	847	N-904-374-01	20830	353	3C0-837-975	22714	849	18936-7	23914	118
90468-04038	16306	847	N-905-369-01	22238	525	3C0-853-585	21761	850	18840-9	23919	118
90520-01002	2288	435	N905-410-01	22721	851	3C0-853-586	22445	853	190-990-2	23911	118
90520-01274	2288	435	N90561601	18661	288	3C0-853-934	22280	531	30753487	22138	862
90520-01274	23785	435	N-906-349-01	17006	352			579, 858	30753556	22137	862
		847	N90-757-901	22418	862	3C0-863-559	22338	462	30808521	22340	862
90541-09069	22413	820	N-907-750-01	22111	44			521, 854	3104-426	13173	850
90541-09124	22490	820			57, 92, 102	3CN-868-243	25340	507			862
90561-13003	22709	757	N-907-758-01	22110	44			523, 857	31214496	22556	862
	847				55, 92, 99	3D0-864-812-A-B41	22441	860	3541113	16782	555
90561-A0001	22843	848	N90-796-501	21485	861	3D0-864-851-B41	22411	860			572, 713, 799
		819	N90-796-502	21485	861	3D0-898-501-B-B41	22715	860	3541113	22765	550
90904-67036	20390	819	N-908-132-01	20746	318	3W0-971-838	22954	300			580, 863
90904-67037	20391	819	N-908-132-02	20746	318			860	591-740	12637	862
90950-01620	22097	758	N-908-214-01	20925	851	441-863-987B	21485	861	8659732	25117	483
		847	N90833801	21816	852	443-857-847-B-4PK22918	22208	860			522, 863
90950-08004	22159	822	N-908-338-01	20924	851	4A0-805-121C	22208	855	9133073	20407	568
90959-01136	17631	846	N-908-920-01	22111	44	4A0-805-163	21815	852			575, 863
90980-11875	25160	223	N90-911-301	22449	458	4A0-853-825-A	21493	849	9133073-8	20407	568
		249, 277			57, 92, 102	4A0-867-276	21818	861	9133417	19904	537
90981-11067	16921	286	N-910-189-01	22291	862	4A0-867-276-A	22108	850			575, 863
90981-11069	B7443	290	N-910-197-01	25341	350	4D0-807-300	22101	561	9133417-7	19904	537
90981-13018	20600	288	N-910-197-01	25341	350	4D0-867-299D	22204	857			573, 863
90981-13046	16897	288	N91167901	24263	316	4F0-805-163	22098	861	9182822	22554	863
90981-13046	B9005	291	N91167901	24263	316	4F0-825-429A	22235	853	946-418	13220	115
90981-13047	B9006	292	N-911-829-01	22829	543			484			779, 805, 863
		288			859	4F0-831-719	22716	521, 855	947-098	13230	524
90981-13055	18661	288	N989021	11612	451	4H0-825-429-A	25036	849			570, 775, 863
90981-13063	BH7	292			509	4L0-886-373	22094	852	95290	13173	850
90981-13075	BH11	292	N989022	11351	461	4M0-805-163	25263	486			862
90981-AD006	BH11	292	N989-051-01	11678	506			523, 856	977751	24317	306
90982-08188	15926	211			509	5J0-853-573	25314	853	977751-7	24317	306
90982-08189	15927	211	WHT-000-713	22850	861	5K0-837-975A	22759	580	979878	19376	352
90982-08202	15930	211			859			588	979878-6	19376	352
90982-08203	15931	211	WHT-004-994	22722	561	5Z0-853-695	22849	852			319
90982-08223	15929	211			541	6E0-837-732	22717	854	986833	24262	319
90982-09019	21602	213	WHT-005-263	22828	541	6K0-868-243-C	21398	507	989750	BH9	292
90982-09025	21604	213			859			517, 856	989826	B9005	291
93904-46320	16960	64	WHT-005-296	25261	112	6N0-809-966A	21816	852	989829	BH7	292
		67			145, 861	6N0-867-276	22216	853	989838	BH11	292
99132-12050	B168	290	WHT-006-099	22822	690	6Q0-807-643	22399	854			

O.E.M. INTERCHANGE BY NUMERICAL ORDER

The O.E.M. numbers listed in this interchange are cross referenced to the closest equivalent Auveco part. In some instances, the parts are not identically the same. There may be slight differences in the finish, length or washer outer diameter; however, the Auveco part is designed to service the same application.

This interchange is arranged numerically in ascending order regardless of the number of digits in each O.E.M. number. Thus every number that begins with a 1 is listed before any number that begins with a 2. You should key on the first four digits to locate the number. For example, 1121865 is located before 11229 and after 11189734.

OEM numbers that begin with a letter precede OEM numbers that begin with a numeral.

OEM No.	Auveco No.	Page No.	OEM No.	Auveco No.	Page No.	OEM No.	Auveco No.	Page No.	OEM No.	Auveco No.	Page No.
A20Z-13410B	13537	241	AJ03-10-404	24271	315	C2S9354	14753	540,	D6AZ-5403178-B	23723	437,
AB009005	B9005	291	AK42ABS	8299	339		571, 601, 638, 656				588
AB009006	16898	288	AK44ABS	8928	339	C2211575	22247	734	D6TZ-6730-A	14196	311
AB009006	B9006	292	AK44BS	8914	339	C2211576	22246	734	D7LZ-6540368-A	23659	636
AB-181-GG	16893	80,	AL8Z-13411-B	23100	244	C3AZ-13466-D	20285	287	D7TZ-13466-A	18008	286
		86	AM5Z-16828-A	22891	644	C3DZ-13466-A	16904	286	D7TZ-13466-A	B912	290
AB3-2A	19053	339	B003-68-865-00	21755	452,	C3DZ-13466-A	B1156	290	D7VY-6050074-A	13966	141,
AB4-2	8905	339			518, 763	C5AB-14474-B	14892	196			807
AB4-2A	8309	339	B003-68-865-09	17453	452,	C5AB-6220586-A	8853	469,	D8BZ-13466-A	16922	286
AB4-4	8911	339			511, 763			509	D8BZ-13466-A	B906	290
AB4-4A	8925	339	B003-68-865-96	17453	452,	C5ZZ-6543413-B	8941	438	D8BZ-5423342-A	13030	648
AB4-6A	16031	339			511, 763	C5ZZ-6543413-B	23582	437	D8TZ-6730-A	19365	321
AB4-8	19049	339	B040-68-865-A09	21112	533,	C6AB-6242413-A	9353	438	D90Z-6522841A	14551	648
AB4-8A	16032	339			576, 600	C7AB-14A163-C	12729	613	D9AE-9E645-AA	12921	172
AB5-2A	18727	339	B040-68-865-A96	21112	533,	C7AZ-2814-A	23887	883	D9AZ-14474-F	16344	195
AB5-3A	18728	339			576, 600	C75Z-13466-B	16921	286	D9AZ-5403178-A	23696	438
AB5-4	19050	339	B040-68-865-A96	23822	580,	C75Z-13466-B	20706	293	D9AZ-54234A44-A	23626	439
AB5-4A	18729	339			600, 637	C75Z-13466-B	B168	290	D9AZ-54234A46-A	23626	439
AB5-6A	18730	339	B092-50-715	17195	630,	C80Z-13711A	12237	215,	D9BZ-5402316-B	23699	630
AB5-8A	18731	339			651, 692, 733, 782			241	D9OZ-6522841-A	14551	648
AB6-10A	18489	339	B092-51-833	17632	542,	C80Z-13711-A	12237	215,	D9ZZ-6221060-A	23708	632
AB6-2	8295	339			572, 638, 726, 766			438	DB5Z-13N021-B	B9005	291
AB6-2A	5755	339	B100-68-675-69	21119	557,	C8AB-6342413-C	8941	438	DCE100560	22485	741
AB6-4	8307	339			576, 768	C8AZ-63442413-A	9882	438	DG9Z-14526-N	21749	213
AB6-4A	8311	339	B100-68-8550	21110	542,	C8AZ-63642413-A	9882	438	DG9Z-14526-P	21751	213
AB6-6	8297	339			576, 766	C8TZ-13466-A	16899	286	DG9Z-14526-R	21752	213
AB6-8A	8938	339	B101-68-252-00	17478	530,	C8TZ-13466-A	B1157	290	DG9Z-14526-S	21750	213
AB8-6A	19058	339			572, 640, 765	C9AZ-17698-A	19393	440	DJ5Z-13N021-A	BH3	292
ABL4-2A	8922	339	B27K-51-PS7	22049	546,	C9AZ-17698-C	19393	440	DKP5279L	22093	487,
ABL4-4A	8931	339			578, 767	C9AZ-9C492A	19003	171,			520, 742
ABL4-8A	20474	339	B455-56-135	21862	769			433	DR3Z-13466-A	22887	287
ABL6-10A	19057	339	B455-56-741	18458	478,	C9AZ-9C492-B	19001	171,	DYC000091	22151	741
ABL6-4A	19055	339			512, 763			433	DYC000122	22145	741
ABL6-8	19051	339	B45A-56-146A	22424	555,	C9AZ-9C492-C	19000	171,	DYC101420	21657	741
ABL6-8A	19056	339			579, 767, 845			433	DYC500010	25334	481,
AC4-2A	8299	339	B467-68-AC3-02	21858	543,	CJ5Z-13N021-A	B9005	291			523, 742
AC4-4	8914	339			578, 766	CS2Z-6503178-B	24145	437	DYC500020	21853	485,
AC4-4A	8928	339	B5AZ-13466-A	B89	290	CU2Z-14S411-UA	25160	223,			519, 742, 855
AD32ABS	19053	339	B6296-89918	B9006	292			249, 277	DYF500010	25270	743
AD41-43BSLF	19033	342	B629C-C9904	BH3	292	CV6Z-13N021-A	BH1	292	DYH500131	22249	741
AD42ABS	8309	339	B629C-C9907	BH3	292	D001-56-731	22516	768	DYQ500060	22248	548,
AD42ABSLF	8922	339	B657-10-404A	24259	316	D0AZ-10756-A	23615	883			579, 743
AD42BS	8905	339	B7A-16758-A	4273	430	D0DZ-15A434-B	9883		DYR500010	25149	742
AD43-45BS	19025	342	B8A-7029120-A	2752	865			241, 280	E0TB-1063-226AC	16213	447
AD43-45BSLF	19034	342	B8AZ-13466-A	16919	286	D0VY-53234A24-A	24156	440	EOVE9K319AB	12938	171
AD44ABS	8925	339	B9A-6423240-A	3135	434	D0ZB-13A-093AA	11660	626	E114-51-W24	21561	760
AD44ABSLF	8931	339	BB5Z-00817-A	22940	643	D10E-51-SJ3	22511	760	E120-68-ABI	22484	498,
AD44BS	8911	339	BM4-50-355	20971	351	D1AB-14461-AA	14887	195			521, 764, 784
AD46ABS	16031	339	BC1D-56-145	19315	551,	D1AB-6542413-AB	9882	438	E1DZ-16C072-A	23718	632
AD48ABS	16032	339			573, 767	D1AB-65424143-AB	8941	438	E1ZE-9E499-CA	18836	173
AD48BS	19049	339	BC1D-58-762	21705	471,	D1AZ-13410-A	19813	262	E25Y-14421-C	16342	195
AD52-54BS	18743	342			518, 671, 709	D1AZ-13410B	13537	241	E25Y-14421-CA	16342	195
AD52-54BSLF	17468	342,	BC1M-50-0Z5	20984	761	D1AZ-6522841A	14550	624,	E2GZ-6723342-A	13030	648
		352	BE8Z-13N021-B	BH11	292			647	E35Y-13466-A	20294	287
AD52ABS	18727	339	BF67-50715	23818	613,	D1AZ-6522841-A	14550	624,	E35Y-13466-B	18012	286
AD53-55BS	19027	342			630, 768, 817			647	E3DB-14A163-CA	14007	539,
AD53ABS	18728	339	BF82-50-233	16843	569,	D1AZ-6542413-B	9882	438			570, 602, 657
AD54ABS	18729	339			572, 768, 801	D1AZ-65432413-B	8941	438	E3DZ-14A163-A	14007	539,
AD54ABSLF	18732	339	BGV4-56-145	22515	555,	D1FZ-13234-A	14135	242			570, 602, 657
AD54BS	19050	339			579, 767	D1FZ-13234-A	14135	242	E3MY-13466-A	18006	286
AD56ABS	18730	339	BK3Z-00817-AA	25113	636	D1FZ-13466-B	16913	286	E3MY-13466-A	20291	287
AD58ABS	18731	339	BM5Z-13N021-A	BH11	292	D1FZ-6222600-A	12470	648	E3SB-6342413-AB	13564	438
AD610ABS	18489	339	BM5Z-13N021-B	BH11	292	D2AZ-6522008-A	18892	647	E3SZ-6342413-A	13564	438
AD610ABSLF	19057	339	BN8F-50-355	22501	352	D2FZ-6222600-A	12470	648	E3TB-1063-226AA	16213	447
AD62-64BS	18744	342	BP4K-58-762	21307	477,	D20B-13A093-AA	11660	626	E3TZ-6734-A	24307	308
AD62-64BSLF	19036	342			517, 762	D20B-13A093-AA	11661	626	E5AZ-14305-AA	18218	250
AD6270UG	17421	346,	BP4L-51-SJ3	21171	760	D20B-14421-BB	20815	195	E5LY-13N021-A	16896	288
		359, 667	BSS800	12654	358	D2VZ-6521952-A	14967	619,	E5LY-13N021-A	B9004	291
AD62ABS	5755	339	BW0B-69-240	19393	440			647, 662, 665	E5RY-13466-B	B194	290
AD62BS	8295	339	C0AB-6423240-B	3135	434	D3AZ-14474-G	20816	195	E5ZZ-12A209-A	18217	253,
AD63-66BS	19028	342	C0AZ-1012-A	8744	129	D3AZ-14526-E	12628	202			261
AD6437UGX	17422	346	C1AB-6220807-A	3639	473,	D3AZ-14526-H	12628	202	E6AZ-5421952-A	15675	647
AD64ABS	8311	339			509	D3AZ-14526-Z	12627	202	E6DZ-13466-B	18005	286
AD64ABSLF	19055	339	C1SF-14474-A	15504	196	D3OZ-16776-A	11136	473,	E6DZ-13466-B	B916A	290
AD64BS	8307	339	C274-50-133	22519	769			509	E6DZ-5421952A	17122	647
AD66-68BSLF	19037	342	C2AZ-13466-C	16902	286	D4AZ-13466-A	18016	286	E6DZ-5421952-A	17122	647
AD66BS	8297	339	C2AZ-13466-C	B194	290	D4AZ-13466-A	18465	286	E6FZ-13466-B	18016	286
AD68ABS	8938	339	C2C14628	22250	505,	D4LY-13410-A	14133	241	E7EB-14421-EA	16342	195
AD68ABSLF	19056	339			520, 734	D4MY-13466-A	18011	286	E7EB-14461-BA	20475	194
AD68BSLF	19051	339	C2D5807	22157	497,	D4ZZ-13234-A	14130	241	E7EB-14474-CA	16344	195
AD82-86BS	19031	342			520, 734	D5AB-14474-FA	20816	195	E7EB-14488-NA	23171	266
AD8375UG	17423	346	C2S13233	19244	564,	D5VZ-6021066-A	23640	631	E7GZ-17A904-G	16843	569,
AD86ABS	19058	339			573, 642	D60Z-6551026-A	10048	148			572, 768, 801

O.E.M. INTERCHANGE BY NUMERICAL ORDER

OEM No.	Auveco No.	Page No.	OEM No.	Auveco No.	Page No.	OEM No.	Auveco No.	Page No.	OEM No.	Auveco No.	Page No.
E7GZ-6120586-B	18692	471, 512, 763, 834	F4ZZ-6310182-A	20965	635	GJ21-68-885-B69	18206	542, 573, 641, 766	L0000168	B168	290
E7SB-13A093BA	15966	626	F50Y-14603-A	21224	629	GJ6A-50-0Z5	20957	761	L0000194	B194	290
E7SZ-13032-D	15966	626	F57B-16241-AA	21000	635	GJ6A-50-ES1	21304	630	L00002057A	B2057A	290
E7ZZ-13466-B	18007	286	F57E-9C631-AA	15044	566, 571, 608	GJ6A-51-14Y	25071	762	L00003157A	B3157A	290
E804-14526A	15926	211	F57Z-16241-AB	20663	635	GJ6A-58-975	21743	762	L00000881	B881	291
E804-14526B	15927	211	F57Z-7810182-AAA	19441	635	GJ6A-68-162	20958	761	L0000886	B886	291
E804-14526D	15931	211	F5846-30F00	22898	466, 522, 796	GJ6A-68-AB1	18824	491, 512, 764	L0000891	B891	291
E83Z-16758-A	16832	431	F58Z-13411-A	23218	246	GJ6E-50-715-A	20923	568, 576, 637, 765	L0000894	B894	291
E83Z-5421952-B	17122	647	F58Z-16237A02-A	18848	488, 512	GJ6E-50-715B	20923	568, 576, 637, 765	L0000896	B896	291
E8AZ-13466-A	17996	286	F5DZ-13466-B	17996	286	GK2A-50-798	21300	629	L0000906	B906	290
E8EB-14474-PA	23175	267	F5DZ-13466-B	B3156	290	GM9E-63-938A	20960	761	L0000912	B912	290
E8EB-14474-SA	23174	267	F5OY-14603-A	21224	629	GS1E-56-496A	25411	116, 145, 769	L0000911	B911	292
E8EB-14474-VA	16348	195	F5RZ-14A411-AA	23212	252, 266	H001-50-841	14695	700, 761, 782, 790, 826	L0000156	B156	290
E8FZ-5802354-A	19845	463, 514	F5RZ-17698-A	19393	440	HI			L0001157	B1157	290
E8PZ-13411-D	23028	243	F5RZ-6730-B	18374	314	HI0			L0001893	B1893	290
E92Z-17C756-C	17060	637, 768	F5TZ-6734-BA	20453	303	HI1			L0001895	B1895	290
E92Z-6120586-A	18271	475, 512, 763	F65Z-1521952-AA	19658	620	HI10			L0002057	B2057	290
E97B-13A093-BA	16399	626	F67Z-7822008-AA	18890	647	HI11			L0003057	B3057	290
E97B-13A093-BB	16399	626	F6AZ-14A411-AA	18218	250	HI15-67-099	15926	211	L0003156	B3156	290
E9AZ-5422008-A	18891	647	F6DZ-16758-AD	16850	431	HI16-67-099	15927	211	L0003157	B3157	290
E9DB-13N020AA	15940	627	F6DZ-5402316-AA	19238	630	HI17-67-099	15931	211	L0003157AK	B3157A	290
E9DZ-13N129-A	15940	627	F6DZ-5410182-AA	20358	635	HI3			L0003457	B3457	290
E9DZ-6730-B	18025	316	F6HZ-14A464-FUA	23052	264	H200-50-715	23818	613, 630, 768, 817	L0007440	B7440	290
E9DZ-6730-B	19773	317	F6TZ-6730-BA	19279	317, 536, 574, 601	H260-50-6K8	22064	762	L0007440NA	B7440A	290
E9DZ-6734B	18299	302	F75Z-14A411-AA	23202	259	H3			L0007443	B7443	290
E9FZ-5822008-A	18890	647	F75Z-6730-BA	18025	316	H3			L0009004L	B9004	291
E9SB-6302354ACW	15523	460, 510	F75Z-6730-BA	19773	317	H447RX9	23694	547, 580	L0009005	B9005	291
E9SZ-13N021-A	16898	288	F79Z-1123342-AAA	13030	648	H7			L0009006	B9006	292
E9SZ-13N021-A	B9006	292	F7CZ-17C756-EA	16843	569, 572, 768, 801	H9			L0009006XS	B9006	292
E9SZ-13N021-B	16897	288	F7DZ-5402316-AA	19238	630	H9			L0009007QL	B9007	292
E9TZ-13032B	16399	626	F7DZ-7421952-AA	19658	620	HBI			L0009145	B9145	292
E9TZ-13032-B	16399	626	F7UZ-1513284-BA	19421	646	HBI1			L000921E	B921	290
E9TZ-6730-B	19365	321	F7UZ-15238A32	19413	446, 636	HBI21467	14720	479, 510, 783	L00194NA	B194A	290
E9TZ-6730-B	24233	311	F7UZ-15238A32-AAC19413		446, 636	HB2			L002057A	B2057A	290
EA01-50-037	21663	524, 636, 760	F81Z-13411-AA	23100	244	HB3			L003057K	B3057	290
EA01-50-048	18882	636, 760	F81Z-13411-BA	23129	245	HB3			L003157K	B3157	290
EC01-68-AB1	20190	503, 514	F81Z-19D887-AA	20843	251	HB4			L003457-K	B3457	290
EF95-51-0X4	BH13	292	F81Z-6730-AA	20807	313	HB4			L004157NAK	B4157K	290
EOVY-13A506-A	17164	643	F81Z-7A010-A	24221	320	HB5			L00H355W	BH3	292
ET7Z-7A01-A	24217	329	F81Z-7A010-AA	24285	330	HB5			L01255H3	B2060	288
FOCZ-6730-B	24259	316	F85Z-13411-AA	23195	245	HB5			L09005LL	B9005	291
FOTZ-14489-J	19004	256	F8TZ-7A010-AA	24221	320	HC3Z-9J305-A	25046	322	L206-56-652A	B2060	288
FICZ-13466-C	20595	288	F8VZ-54237A02-AA18848	488, 512	512	HP-2			L33X-13-209	BH3	292
FICZ-16674-A	18458	478, 512, 763	FB01-56-964	16000	550, 571, 714, 767, 800	HP-30B			L562	B562	292
FICZ-16774-A	18458	478, 512, 768	FD01-68-AC3	22282	562, 579, 768	HP-30C			L891	B891	292
FITZ-13411-B	23215	246	FL1Z-13N021-A	BH9	292	HP-30D			LA01-51-958	B51958	292
FITZ-13411-E	23214	246	FL3Z-13489-A	22912	632	HP-30N			LA01-56-135	B56135	292
FITZ-13411-F	23213	246	FS50-21-249	22196	316	HS99338-K4700	3611	165	LRO00080	B0080	292
FITZ-13411-G	23216	246	G030-68-885B	14709	453, 510, 763	HS99339-K4700	3610	165	LRO02229	B2229	292
FITZ-17698-A	19393	440	G030-68-885-B-3814709		453, 510, 763	HS99355-K4700	3609	165	LRO12844	B12844	292
FITZ-7810182-A	19441	635	G031-58-762	18692	471, 512, 763, 834	HS99375-K4700	3614	165	LRO18173	B18173	292
FITZ-13466-A	20286	287	G032-68-865A-00	21560	454, 518, 763	HS99376-K4700	3613	165	LRO27255	B27255	292
F22Z-16774-A	14709	453, 510, 763	G18K-51-SJ3	20932	484, 516, 764	HS99417-K4700	3612	165	LRO28939	B28939	292
F2DZ-13466-C	20599	288	G22C-51-SJ3	25099	760	HU2Z-13B765-A	12237	215, 241	LRO3135	B3135	292
F2PZ-14A464-B	23193	255	G350-68-AB1	18824	491, 512, 764	IPN500050	22156	496, 520, 743	LRO32984	B32984	292
F2PZ-14A464-C	19004	256	G46L-50-EB1	22517	762	J001-56-741	21520	478, 517, 763	LRO33144	B33144	292
F2UZ-1602354-AAA	19846	463, 514	G6JA-50-0Z5	20957	761	J4004175	9298	126	LRO34389	B34389	292
F32Z-17C756-S	17003	645, 769	GA2A-56-694	14709	453, 510, 763	J4004354	9297	126	LRO45194	B45194	292
F37Z-13411-A	23219	246	GA2A-58-762	19481	470, 513, 765	J4004354	10087	126	LRO53837	B53837	292
F3DZ-6730-A	18025	316	GA5R-56-392	19306	536, 573, 766	J4005293	10087	126	LS101	B101	292
F3DZ-6734-A	18299	302	GA7B-51-146	25056	762	K99564-1800	24317	306	MB023930	B23930	292
F3DZ-6734-A	24344	302	GD7A-50-EA1	20755	549, 576, 767	KA80-51PR6	18882	636, 760	MB029111	B29111	292
F3LB-14K056-AA	17222	534, 572, 603, 640	GHP9-50-355	22448	352	KB8A-51-SJ3	22758	760	MB098145	B98145	292
F3LY-14570-B	17222	534, 572, 603, 640	GJ21-50-034	17060	637, 768	KD45-51-W24	22593	760	MB106212	B106212	292
F3PZ-14A464-D	19126	242	GJ21-50-049	17003	645, 768	KD45-58-762	25072	468, 522, 763	MB132008	B132008	292
F3PZ-14A464-E	19125	242	GJ21-58885-A69	18206	542, 573, 641, 766	KD51-51-W24	22510	486, 521, 764	MB132008	B132008	292
F47Z-13411-A	23217	246	GJ21-68-885B-02	21024	541, 576, 641, 766	KD53-50-M38	25257	480, 523, 764	MB153825	B153825	292
F4CZ-13466-A	16917	286	GJ21-68-885-B02	18206	542, 573, 641, 766	KD53-51-SJ3A	22520	486, 760	MB153825	B153825	292
F4CZ-13466-A	B3157	290	GJ21-68-885-B02	18206	542, 573, 641, 766	KD53-51-W24	22512	486, 521, 764	MB253964	B253964	292
F4PZ-14A411-C	19885	254	GJ21-68-885-B02	18206	542, 573, 641, 766	KKY01-50-715	23818	613, 630, 768, 817	MB253964	B253964	292
F4TZ-13N021-B	18662	288	GJ21-68-885-B02	18206	542, 573, 641, 766	KU5Z-14A163-C	25474	648	MB253964	B253964	292
F4TZ-13N021-B	B9007	292	GJ21-68-885-B02	18206	542, 573, 641, 766	KX6Z-6730-B	24267	313	MB325299	B325299	292
F4UB-14A464-A	19004	256	GJ21-68-885-B02	18206	542, 573, 641, 766	L0000000H7					
F4UZ-13B765-A	12237	215, 241	GJ21-68-885-B02	18206	542, 573, 641, 766	L000000080					
F4VY-14A411-A	20846	250	GJ21-68-885-B02	18206	542, 573, 641, 766	L0000067					
F4VY-14A411-S	20846	250	GJ21-68-885-B02	18206	542, 573, 641, 766	L0000089					
F4XY-1200586-A	17339	472, 511	GJ21-68-885-B02	18206	542, 573, 641, 766	L00000H9					
F4XY-6734-A	21258	309	GJ21-68-885-B02	18206	542, 573, 641, 766	L0000168					

O.E.M. INTERCHANGE BY NUMERICAL ORDER

OEM No.	Auveco No.	Page No.	OEM No.	Auveco No.	Page No.	OEM No.	Auveco No.	Page No.	OEM No.	Auveco No.	Page No.
MB325299	16671	847	MS480001	14255	699,	N185161	11098	120,	N801169-S900	22104	43,
MB358818	15926	211			761, 782			326			52, 91, 97
MB358819	15927	211	MS480002	13932	782,	N185301	11100	120,	N801293-S36	23900	80,
MB361578	25428	783			824			326			83
MB374270	21118	498,	MS480003	23971	650	N304-13-356A	14697	529,	N801554	15040	455,
		516, 784,	MS480009	13932	782,		570, 599, 713, 765	765			510
MB374271	21118	498,			824	N304-13-356B	14697	529,	N801603-S2	20271	43,
		516, 784,	MS480012	14695	700,		570, 599, 713, 765	765			52, 91, 97
MB455-56143	17632	542,			761, 782, 790, 826	N605920-S2	12327	81	N801706-S	12569	627,
	572, 638, 726, 766		MS661162	24289	331	N606675-S2	23688	80			649
MB475404	17162	532,	MS820083	B9005	291	N606676-S100	12160	80,	N801851-S45	14947	80,
		572, 601, 841	MS820959	16897	288			85			86, 139
MB475404	17162	532,	MS820961	BH1	292	N606676-S100	15778	80,	N801925	12565	487,
		572, 601, 841	MS820964	BH3	292			85			509
MB547806	17472	557,	MS820970	B9004	291	N606676-S2	12160	80,	N801925-S	12565	487,
		572, 785, 801	MS820978	BH11	292			85			509
MB547806	17472	557,	MS820978	BH13	292	N606676-S36	15778	80,	N801994	19667	454,
		572, 785, 801	MS820979	BH7	292			85			513
MB566719	19802	488,	MU000319	19239	552,	N606677-S36	12335	80,	N801994 DUP	19667	454,
		514		580, 606, 675, 711, 756, 785	785			86			513
MB566720	19334	485,	MU000573	22513	484,	N606677-S43B	15779	80,	N801994-S100	19667	454,
		513, 784			521, 784			86			513
MB566720	19334	485,	MU000695	25206	562,	N606677-S53B	15779	80,	N802224-S	20316	461,
		513, 784			580, 660, 785			86			514
MB608104	19129	502,	MU000695	25206	562,	N606689-S2	23817	81	N802239-S	17643	643
		513, 839			580, 660, 785	N606690-S2	15780	81,	N802241-S	17642	644
MB608104	23559	503,	MU000977	22462	482,			88	N802331-S53	16842	116,
		522, 839			521, 784	N606690-S55	15780	81,			151
MB608104	19129	502,	MU001220	25206	562,			88	N802376-S	14754	627
		513, 839			580, 660, 785	N606692-S2	16931	81,	N802538	14526	147
MB608104	23559	503,	MU001220	25206	562,			89	N802538-S100	14526	147
		522, 839			580, 660, 785	N610959-S2	13019	45,	N802734-S	15480	460,
MB608140	19330	782	MU001282	22589	460,			59, 92, 103			510
MB619582	21140	532,			521, 783	N621900	15325	109	N802734-S	19197	461,
		576, 785	MU480034	19322	782	N621903	15326	109			513
MB6565630	22082	477,	MU481027	19325	469,	N621905	15328	109	N802775-S36	16883	109
		519, 783			513, 784	N621905-S2	15328	109	N802781-S	14020	565,
MB696120	19320	481,	MU481187	19323	477,	N621906-S2	23685	109			570, 608
		513, 784			513, 783	N621906-S361	16774	109	N802865-S100	18153	616
MB696120	19320	481,	MU481283	19749	471,	N621906-S437	16774	109	N802865-S100	24179	616
		513, 784			514, 834	N621906-S441	23685	109	N802900-S	12565	487,
MB814419	19314	782	MU840004	15931	211	N621907	15332	109			509
MB869072	19331	475,	MU840015	15926	211	N621907-S2	23686	109	N802900-S	13470	487,
		513, 783	MU840016	15927	211	N621940-S424	15335	109			509
MB879499	22077	541,	MU840021	15931	211	N621940-S424	23656	109	N803043-S	13750	342
		578, 785	MWC3136	22085	741	N621942-S2	15337	109	N803170-S	14021	450,
MB887567	17351	538,	N0138042	23911	118	N621942-S301	15337	109			510
		572, 785	N013804-2	23911	118	N621942-S441	15337	109	N803183-S32	14814	144
MB888869	19140	558,	N013806-2	23914	118	N623330-S2	18337	116,	N803362-S	13993	540,
	573, 599, 656, 676, 785, 845		N0138083	23915	118			149			570, 604, 640
MBF82-50-233	16843	569,	N013808-3	23915	118	N623331-S2	18338	116,	N803387-S	15668	465,
		572, 768, 801	N0138115	23914	118			150			511
MC440901	20381	476,	N0138128	24330	306	N623332-S100	11864	116,	N803387-S300	15668	465,
		515, 703, 783, 795	N013814-1	23918	118			151			511
MD050317	19007	309	N013814-2	23927	118	N623332-S2	11864	116,	N803387-S300	16863	465,
MD145018	24289	331	N0138178	24330	306			151	N803421-S	14019	565,
MD400250	24281	330	N013832-2	23919	118	N623332-S21	12669	116,			570, 642, 660
MF453091	21746	44,	N013844-2	14871	118			151	N803494-S	14953	568,
		56, 92, 100	N013848-5	23928	118	N623332-S439	12669	116,			571, 598, 636
MG350-68AB1	18824	491,	N-013-849-2	20454	307			151	N803613-S	16863	465,
		512, 764	N013849-3	19621	306	N623332-S53	12669	116,			511
MG350-68AB1	18824	491,	N013849-3	23442	118			151			511
		512, 764	N013849-S	24232	332	N623333-S100	11629	117,	N803678-S	23884	458,
MNA01-56145	16858	557,	N-014-389-3	13173	850,			152			522
	572, 639, 739, 767, 800				862	N623333-S2	11629	117,	N803685-S11	14820	617,
MRI38807	18951	559,	N0160276	24263	316			152			644
		573, 786	N016-185-7	5748	338	N623340-S2	11625	116,	N803709-S	17103	534,
MR200300	20247	542,	N0385491	19195	536,			149			640
		575, 711, 785			573, 858	N623343-S100	11630	117,			572, 603, 640
MR200300	20247	542,	N-038-550-1	21391	527,			152	N803716-S	14018	546,
		575, 711, 785			577, 858	N623343-S2	11630	117,			570, 641
MR221507	21623	782,	N043815 2	23910	118			152	N803734-S	15480	460,
		817	N0438541	24302	309	N623344-S2	18339	117,			510
MR280579	25428	783	N-102-563-01	B9007	292			153	N803763-S100	20415	618,
MR288150	21658	531,	N-102-593-01	20187	525,	N800296-S439	22700	117,			646
		578, 785, 813			573, 775, 857			151	N803857-S	20311	451,
MR322000	21690	485,	N-103-180-01	22826	852			44,			514
		518, 784	N-103-201-01	16897	288	N800312-S2	15776	59, 92, 103	N803862-S	13751	342
MR328954	19274	551,	N10320102	16897	288			64,	N803933-S101	17408	346,
		573, 800	N-103-201-02	BH7	292	N800369	16422	66			348
MR328954	19274	551,	N105-073-01	22720	852	N800369-S2	16421	64,	N803934-S	13994	565,
		573, 800	N-105-835-01-9B9	22830	528,			65			570, 608, 642
MR380850	25347	472,			858	N800387-S	11842	464,	N803946-S	14992	534,
		523, 784	N-106-213-01	21988	852			509			571, 637, 655
MR435918	20571	481,	N10-700-901	22421	531,	N800394-S2	23811	80	N804189-S	13747	341
		515, 784			579, 858	N800466	15325	109	N804193-S100	18167	347
MR478262	20580	532,	N-107-009-01	22421	531,	N800484-S58	16736	19	N804343-S	13748	341
		575, 657, 785			579, 858	N800503-S	11841	629	N804344-S	14967	619,
MR478263	20581	651,	N10724402	B7440	290	N800744-S	16986	37,			647, 662, 665
		783	N14-4003	11404	74,			106	N804349S	15479	463,
MR489986	22361	484,			106	N800854-S2	18449	116,			510
		521, 733	N185101	11101	120,			151	N804349-S	15479	463,
MR975267	22484	498,			326	N800947-S	16893	80,			510
		521, 764, 784	N185112	11099	120,			86	N804376-S	16421	64,
MS452348	21744	44,			326	N801117-S100	18401	117,			65
		58, 92, 103	N185151	11097	120			153			

O.E.M. INTERCHANGE BY NUMERICAL ORDER

OEM No.	Auveco No.	Page No.	OEM No.	Auveco No.	Page No.	OEM No.	Auveco No.	Page No.	OEM No.	Auveco No.	Page No.	
N804376-S307	16421	64, 65	N807721-S	17612	458, 511	N-910-197-01	25341	350	TD11-56-694	21661	453, 518, 763	
N804376-S55	16421	64, 65	N807875-S	19524	508, 513	N91167901	24263	316	TD12-51-SJ3A	21412	486, 517, 765	
N804379-S	15478	462, 510	N807943-S	19810	487, 514	N91167901	24263	316	TY98TL2-AA	20541	465, 515	
N804448	14757	454, 510	N807994-S	18816	631	N-911-829-01	22829	543, 859	UB39-45-919	20465	540, 575, 766	
N804570-S	14753	540, 571, 601, 638, 656	N808041-S437	20742	618	N989021	11612	451, 509	UB39-50-795	19747	541, 573, 766	
N804570-S	14993	540, 571, 776	N808048-S	16726	544, 572, 641	N989022	11351	461, 509	W17430-S300	22914	630	
N804583	15187	341, 353	N808147-S	14991	539, 571, 600, 638	N989-051-01	11678	506, 509	W520802-S439	11864	116, 151	
N804583-S	15187	341, 353	N808182-S309	19436	646	NAO1-56-145	16858	557, 572, 639, 739, 767, 800	W520802-S439	22584	116, 151	
N804614-S	13994	565, 570, 608, 642	N808182-S439	19436	646	NAO1-56145	16858	557, 572, 639, 739, 767, 800	W520802-S439	22584	116, 151	
N804674-S	15701	564, 571, 642	N808331-S	18895	540, 573, 638	NE51-51-SJ3A	21678	484, 518, 764	W520813-S439	22699	117, 153	
N804675-S	17101	342	N808332-S	18894	539, 573, 638	OWX68BD5-AA	21021	561, 576, 657	W520821-S426	18338	116, 150	
N804759-S	15491	342	N808370-S	19127	459, 513	PR2		16927	286	W520821-S439	18338	116, 150
N804765-S	19277	628	N808679-S	15480	460, 510	PT1383		22934	232	W520821-S439	18338	116, 150
N804837-S	14994	565, 571, 639	N808689-S417	19458	347	PT1795		22936	233, 278	W520821-S439	18338	116, 150
N804851-S100	19516	359	N808791	20273	575, 639, 656	PT2048		25210	227, 236, 278, 279	W520822-S426	12669	116, 151
N804992-S58	10654	22	N808842-S	19338	464, 513	PT2427		22935	226, 233, 238, 277, 278, 280	W520822-S439	22579	116, 151
N805026S	14995	528, 571, 600, 637, 655	N808847-S	19244	564, 573, 642	PT2468		22931	219	W520822-S439	22579	116, 151
N805026-S	14995	528, 571, 600, 637, 655	N808908-S	19337	530, 573, 642	PT516		13547	223	W520823-S426	11629	117, 152
N805083-C	16832	431	N811006-S	18936	507, 512	PT549		11440	231, 272	W520823-S439	11629	117, 152
N805155-S	17124	487, 511	N811018-S100	17639	359	PT553		25211	230	W520823-S439	22700	117, 151
N805229-S	14988	526, 571, 637	N811018-S100	19263	359	PT728		22932	228, 233	W520832-S424	12575	117, 152
N805231S	15522	536, 571, 639	N811040-S	20893	450, 516	R4357		11104	339, 348	W520832-S426	12575	117, 152
N805231-S	15522	536, 571, 639	N811169-S	19783	631, 747, 825	RYH500840		25426	742	W525157-S300	22540	354, 346
N805315	17381	464, 511	N811257-S100	20421	646	RYQ500070		14753	540, 571, 601, 638, 656	W525170-S417	19414	346
N805315-S	17381	464, 511	N811257-S309	20421	646	RYQ500170		22248	548, 579, 743	W525172-S417	19461	346
N805592-S100	17121	354	N811283-S	20545	544, 575, 638	S47P-64-345		22483	758, 768	W525175-S	19456	347
N805612-S	17102	488, 511	N811353-S100	20171	630	S51S-51-833		21662	525, 578, 765	W525175-S300	19456	347
N805612-S100	17102	488, 511	N811460-S100	19419	350	SB3-4		19045	338	W623463-S54	8868	127
N805660-S	15672	538, 571, 656	N811478-S100	20927	72, 628	SB4-1		19046	338	W700158-S300	23871	631
N805759-S100	16834	350	N811534-S61	19653	43, 91, 98	SB4-2		19046	338	W700566-S300	18383	627
N805889-S100	19480	117, 152	N811540-S	20360	459, 515	SB4-3		8874	338	W700671-S300	20319	459, 514
N806113-S	20189	459, 514	N811772-S	19472	610, 643	SB4-4		5753	338	W701054-S300	18503	566, 573, 642
N806126-S100	17408	346, 348	N900845-01	17006	352	SB4-6		8880	338	W701259-S300	10831	457, 509
N806191-S1901	17643	643	N-900-845-01	17006	352	SB4-8		19047	338	W701374-S	20399	453, 515
N806289-S	17339	472, 511	N90100001	12595	109, 862	SB5-2		8883	338	W701374-S300	20399	453, 515
N806322-S	18893	539, 573, 637	N90100001	23684	109	SB5-4		8886	338	W701380-SSW	18379	455, 512
N806334-S	20245	627	N-901-686-02	22113	116, 149, 150, 690, 861	SB6-4		8892	338	W701430-S300	18377	632
N806340-S	19850	469, 514	N90168604	22113	116, 149, 150, 690, 861	SB6-6		8895	338	W701649-S	19237	44, 56, 631
N806344-S	18277	463, 512	N90-229-301	22095	561, 578, 859	SBL4-2		8291	338	W701650-S	19238	630
N806363-S	20264	630	N-902-889-01	21352	316	SBL4-4		8293	338	W701855-S300	20366	456, 515
N806728-S439	25077	116	N90-335-006	21513	861	SBL6-6		8305	338	W701971	20169	533, 573, 642
N806830-S100	17639	359	N903-521-01	22418	862	SC4-2		5751	338	W701993-S	17604	423
N806830-S100	19263	359	N903591-01	20234	533, 575, 685, 775	SC4-4		8303	338	W702413-S303	22348	44, 57, 92, 102
N806903-S	23899	564, 580	N-904-374-01	20830	353	SD34BS		19045	338	W702413-S307	22348	44, 57, 92, 102
N806959-S	19235	423	N905150-S	17466	356	SD41BS		19046	338	W702413-S450B	22348	44, 57, 92, 102
N807154-S	19373	458, 513	N-905-369-01	22238	525, 579, 858	SD42BS		5749	338	W702438-S300	22359	631
N807154-SZUD4	19373	458, 513	N905-410-01	22721	851	SD42BSL		8291	338	W702512-S900C	22023	357
N807168-S	19111	356	N90561601	18661	288	SD43BS		8874	338	W702554-S900	22066	358
N807189-S100	20171	630	N90-906-349-01	17006	352	SD44BS		5753	338	W702554-S900C	22066	358
N807247-S	19526	631	N90-757-901	22418	862	SD610BS		8902	338	W702926-S	18744	342
N807389-S	17216	557, 572, 606, 641, 659	N-907-579-01	22418	862	SD627OUG		17425	346	W703243-S300	25178	530, 580, 640
N807455-S100	23888	645	N-907-750-01	22111	44, 57, 92, 102	SD62BS		8889	338	W703475-S300	23955	630
N807535-S	19760	460, 514	N-907-758-01	22110	44, 55, 92, 99	SD64BS		8892	338	W704340-S300	14020	565, 570, 608
N807535-SSZ	19760	460, 514	N90-796-501	21485	861	SD66BS		8895	338	W704342-S300	13751	342
N807577-S	18895	540, 573, 638	N90-796-502	21485	861	SD66BSL		8305	338	W704344-S417	19111	356
N807578-S	18894	539, 573, 638	N-908-132-01	20746	318	SD68BS		8899	338	W704433-SS35B	17216	557, 572, 606, 641, 659
N807620-S100	18461	351	N-908-132-02	20746	318	SD816BS		19048	338	W704740-S300	18816	631
N807673-S	22058	529, 578, 637	N-908-214-01	20925	851	SD8375UG		17427	346	W704823-S439	21040	116, 149
			N90833801	21816	852	SK42BS		5751	338	W704874-S439	22537	43, 50, 91, 99
			N-908-338-01	20924	851	SK44BS		8303	338			
			N-908-920-01	22111	44, 57, 92, 102	SSB4-4S		19060	339			
			N90-911-301	22449	458, 521, 854	SSB6-8S		19061	339			
			N-910-189-01	22291	862	SSBN4-3		11104	339, 348			
			N-910-197-01	25341	350	SSC42		5750	338			
						SSD44SSBS		19060	339			
						SSD68SSBS		19061	339			
						SSP42		5748	338			
						SU003-02194		21326	318			

O.E.M. INTERCHANGE BY NUMERICAL ORDER

OEM No.	Auveco No.	Page No.	OEM No.	Auveco No.	Page No.	OEM No.	Auveco No.	Page No.	OEM No.	Auveco No.	Page No.
W704875-S439	22549	43	W708513-S309	20776	646	W712196-S300	20889	558	W717337-S900	22884	360
W704881-S300	19237	51, 90, 96, 44,	W708530-S300	20632	559,	W712324-S439	22865	576, 607, 641	W717736-S300	22154	741
W704897-S417	19419	56, 631	W708621-S300	20190	575, 607			116,	W717793-S439	22915	81,
W704958-S300	19511	350	W708633-S300	21313	503,	W712665-S300	20993	150	W717823-S300	22532	88
W705002-S300	19338	534,	W708713-S900	22876	514	W712792-S300	22541	564,	W717870-S300	18030	579
W705297-S300	21245	573, 643	W708714-S900	22877	517	W712930-S437	8892	576, 608, 642	W717918-SS34X	25182	522
W705376-S900	17420	464,	W708717-S900	22878	360	W712990-S300	25217	478,	W717970-S300	22474	629
W705436-S300	19801	464,	W708761-SSB	15480	460,	W713202-S300	21172	521, 672	W717984-S417	22333	353
W705532-S300	16726	513	W708761-SSE	19760	510	W713297-S300	21169	529,	W718033-S300	22179	482,
W705550-S300	19783	573, 640	W708771-S300	20530	460,	W713331-S300	20989	577, 637	W718037-S300	22354	520
W705589-S	11146	544,	W708777-S437	22023	514	W713445-S300	21172	503,	W718046-S300	22927	545,
W705589-S	15414	572, 641	W708777-S900C	21286	460,	W713590-S300	21174	516, 544, 666, 667, 711	W718088-S300	22227	579, 658
W705589-S	19250	631,	W708777-S900C	22023	514	W713610-S300	20988	546,	W718155-S300	22916	630
W705589-S300	11146	747, 825	W708778-S900C	21286	630	W713617-S439	25352	576, 605, 641	W718226-S451	25282	645
W705589-S300	15414	457,	W708888-SAB	17664	357	W713651-S300	21247	644	W718230-S300	21206	496,
W705590-S300	20466	509	W708888-SD	17664	358	W713727-S300	25089	644	W718240-S300	21230	516, 707
W705681-S300	20360	457,	W708991-S439	22702	511	W713819-S900	21864	500,	W718365-S300	22284	635
W705711-S417	19414	509	W709002-S	20624	116,	W714004-S900	22264	516	W718369-S300	22475	564,
W705845-S300	17632	510	W709002-SAA	20624	149	W714004-S900	22264	522	W718456-S300	25090	579, 642
W705848-S300	572, 638, 726, 766	457,	W709176-S300	19639	455,	W714030-S424	25276	522	W718477-S439	25312	629
W705849-S300	20355	14753	W709176-S300	19639	515	W714030-S424	25276	351	W718478-S439	25311	82
W705894-S300	20245	540,	W709346-S300	17664	455,	W714040-S300	20880	356	W718818-S902	25312	82
W705955-S300	20177	571, 601, 638, 656	W709346-S300	17664	515	W714076-SS3JA	22180	545,	W719084-S300	22493	465,
W705956-S300	20233	636	W709371-S300	23966	457,	W714113-S439	25277	605	W719209-S300	25354	521
W705958-S439	22837	629	W709688-S300	21790	511	W714171-S439	22844	520	W719365-S902	25313	633
W706009-S300	16954	585,	W709688-S300	21790	511	W714172-S300	25088	645	W719367-S300	22349	82
W706092-S300	21098	629	W709767-S300	20663	522	W714231-S300	22251	628	W719534-S300	25407	530,
W706172-S309	20401	510	W709883-S300	13467	632	W714241-S300	25348	485,	W719880-S417	20741	579, 640
W706182-S300	20516	575, 639	W709984-S300	20631	635	W714372-S300	20427	520, 743	W719957-S300	25350	617
W706350-S3000	14992	515	W709995-S300	21247	466,	W714584-S300	20766	647	W721069-S300	25091	355
W706358-S300	15478	629	W710246-S900	22879	466,	W714599-S900	17420	503,	W76675-S439	22913	644
W706436-S300	22723	116,	W710250-S300	21089	547,	W714972-S300	22161	515	W790173-S900	21202	522
W706494-S300	19849	151	W710312-S300	20761	500,	W714975-S300	20992	346	W790225-S900	22021	589
W706635-SSW	21241	576, 638	W710339-S300	23973	516	W714975-S300	20992	589	W790383-S900	25290	633
W706676-S300	17664	646	W710459-S300	20466	576, 638	W714996-S300	22864	576, 607	W790486-S900	25283	486,
W706713-S300	20367	554,	W710528-S300	20817	629	W715030-S437	8892	430	WHT-000-713	22850	523
W706737-S300	17121	628	W710532-S300	20926	613	W715030-S437	8892	338	WHT-004-994	22722	861
W706737-S300	17121	545,	W710752-SSC	14992	43,	W715060-S439	25101	43	WHT-005-263	22828	561,
W706738-S300	20190	573, 639	W710754-S439	21187	571, 637, 655	W715197-S439	22818	53, 91, 98	WHT-005-296	25261	859
W706739-S300	20190	463,	W710763-S901	22104	613	W715201-S300	21668	645	WHT-006-099	22822	541,
W706812-S300	19386	516	W710791-S437	21215	43,	W715256-S300	21192	644	WPT-1025	23061	859
W706815-S300	21257	457,	W710825-S300	22924	52, 91, 97	W715537-S300	20826	576, 606	WPT-118	20851	112,
W707157-S300	20245	511	W710923-S300	18680	462,	W715544-S300	22304	800	WPT-I277	25160	145, 861
W707291-S439	20339	545,	W711031-S300	21826	512	W715801-S439	25278	577, 731, 767, 800	WPT-159	20842	690
W707501-S300	12253	573, 639	W711035-S300	21826	512	W715926-S300	21673	548,	WPT-169	20843	244
W707504-S900	23973	463,	W711035-S300	21826	512	W715951-S300	22053	606	WPT-173	18671	250
W707593-S300	20190	516	W711035-S300	21826	512	W715980-S439	25279	644	WPT-335	20848	242
W707638-S900C	22067	516	W711035-S300	21826	512	W716006-S439	25001	614,	WX68BD1-AA	20948	561,
W707889-S300	20192	516	W711035-S300	21826	512	W716006-S439	25001	646	WX68DX9-AA	20739	646
W708035-S300	20531	516	W711035-S300	21826	512	W716053-S451	25280	643	XF5Z-14S411-AA	14918	561,
W708319-S300	21239	516	W711035-S300	21826	512	W716156-S303	12255	645			575, 657
W708325-S300	14998	516	W711035-S300	21826	512	W716165-S439	22840	107	XL3Z-13466-AA	BH10	217,
W708384-S309	20401	516	W711035-S300	21826	512	W716350-S300	20977	645	XL3Z-13466-AA	BH9	242, 276
W708456-S309	16883	516	W711035-S300	21826	512	W716351-S300	21668	636	XL3Z-13466-AA	BH9	292
W708464-S450B	22428	516	W711035-S300	21826	512	W716351-S300	22099	634	XL3Z-17E971-AA	19607	292
		85	W711037-S300	20949	503,	W716352-S300	22124	634			536,
			W711079-S300	21368	516	W716460-S300	21187	613	XR819630	20363	573, 639
			W711139-S300	8892	628	W716460-S300	22038	633			532,
			W711390-S900	22232	338	W716497-S300	21669	634	XR821729	20363	575, 643
			W711401-S450B	25150	80,	W716503-S300	22033	634			575, 643
					87	W716507-S300	22269	493,	XR831159	22256	563,
					43,			520			579, 734
					54, 91, 98	W716510-S300	21703	542,	XR87508	20233	563,
					629			578, 638			575, 639
					504,	W716529-S900	22289	616,	XWIZ-5822008-AA	18891	647
					516			644, 663	XW4Z-54238A70-AA20363		532,
					516	W716569-S300	25189	632			575, 643
					515	W716783-S300	22431	632	XW4Z-6730-BA	24271	315
					628	W716878-S300	25289	635	XW7Z-6302354-AAB20625		462,
					453,	W716909-S439	25281	645			515
					516	W716969-S300	21703	542,	XX10362-20-K1105	7680	448
					551,			578, 638	XZQ00011	BH7	292
					573, 711	W717086-S439	22491	617	YF4Z-8194-AA	20400	631
					469,	W717182-S900	22880	360	YL8Z-16K262-HC	20755	549,
					517	W717184-S900	22881	360			576, 767
					469,	W717185-S900	22882	360	YR3Z-13466-AD	B3157A	290
					520	W717186-S900	22883	360	YS4Z-13N021-AA	18661	288
					629				YS4Z-16K262-AA	20191	637

O.E.M. INTERCHANGE BY NUMERICAL ORDER

OEM No.	Auveco No.	Page No.	OEM No.	Auveco No.	Page No.	OEM No.	Auveco No.	Page No.	OEM No.	Auveco No.	Page No.
YS4Z-6730-AA	18374	314	000-994-14-45	13215	112	009-988-03-78	22504	773	01553-02741	17378	561
YS4Z-6730-AA	20347	314			690, 779	009-997-36-81	25030	771			572, 801
YS4Z-6734-AA	21180	303	000-994-14-45	13216	112	011-988-76-78	22309	494	01553-02903	22063	483
YU5Z-13466-AD	16901	286		690, 779, 805	809, 861			520, 775		519, 730	796
YU5Z-13466-AD	B3457A	290	000-994-25-45	13223	111	01241-0009U	22584	116	01553-02913	21621	790
ZZLO-10-403A	24344	302			690, 779			151	01553-02923	21688	729
ZZMI-51-472	B9007	292	000-997-01-33	22905	485	01241-00551	17193	114			792
000000-001606	BH11	292			522, 774			804	01553-03101	17378	561
000000-002111	B3457A	290	000-997-91-86	20643		01241-00881	21459	115			572, 801
000000-004145	B921	290	000-998-36-85	25427	772			732, 804	01553-03201	20753	562
000000-008090	BH7	292	001-988-03-25	21105	479	01241-01051	25092	115			576, 801
000000-008789	24263	316			516, 773			732, 804	01553-03269	15481	460
0000-11-0H1	BH1	292	001-988-20-81	20205	772	01281-00023	14275	783			510
0000-11-0H7	BH7	292	001-988-76-81	20205	772			790, 827	01553-03803	19416	544
0000-11-9004	B9004	291	001-988-97-81	22310	469	01281-0003U	19293	791			573, 713, 766, 842
0000-11-9005	B9005	291			520, 773	01281-00072	14256	824	01553-03831	21121	786
0000-11-9006	B9006	292	001-990-01-92	22339	567	01281-00111	22416	789	01553-05131	21637	732
0000-11-H11	BH11	292			579, 777	01281-00151	14335	782			803
000-908-014009	24263	316	001-990-16-92	19195	536			790	01553-05233	22301	728
000-988-15-81	13141	772			573, 858	01281-00231	14275	783			786
000-988-16-25	20647	772	001-990-16-92-64	25222	558			790, 827	01553-05323	21192	553
000-988-16-25	23228	681			580, 777	01281-00331	21111	729			577, 731, 767, 800
		772	001-990-22-92	22920	527			791	01553-05751	16860	786
000-988-76-81	13141	772			580	01281-00431	22176	792	01553-05891	22760	458
000-990-03-92	13230	524	001-991-02-71	25037	770	01281-00441	17342	789			464, 521
	570, 775, 863		001-991-03-71	25060	771	01281-00501	21367	790	01553-05933	21192	553
000-990-22-92	13230	524	001-991-26-98	22305	494	01281-00601	19293	791			577, 731, 767, 800
	570, 775, 863				520, 774	01281-00691	21324	729	01553-06071	21620	533
000-990-29-92	19195	536	001-991-34-71	25336	770			790			578, 799
		573, 858	001-991-39-70	25035	112	01281-00711	20604	729	01553-06451	22075	454
000-990-31-62	25080	778			779			790			519, 730, 796
000-990-32-62	25057	114	001-991-39-70	25035	112	01281-00801	17342	789	01553-06721	17347	552
		780			779	01281-00831	20764	729			572, 801
000-990-34-92	20187	525	001-991-41-98	22948	493			789	01553-06753	25185	477
	573, 775, 857				522, 774	01281-01081	20736	729			523, 795
000-990-37-92	20314	528	001-991-57-98	22950	492			792	01553-07111	20669	499
		575, 775			522, 776	01281-01121	22274	729			515, 731, 797
000-990-40-92	20640	527	001-991-76-70	21818	861			789	01553-08231	21545	556
		575, 775	001-991-77-71	25061	771	01281-01431	22494	791			577, 732, 800
000-990-44-92	20639	527	001-997-42-90	20654	299	012-988-50-78	25082	771	01553-08911	21618	787
		575, 775			778	01451-00841	18340	43	01553-08951	19724	473
000-990-54-92	20234	533	00234-00192	B168	290			54, 91, 99			514, 798
	575, 685, 775		00234-00194	16902	286	01451-00891	20455	44	01553-08961	21295	473
000-990-54-92-905120234	533	533	00234-01156	16904	286			57, 92, 102			517, 794
	575, 685, 775		002-900-20-17	24266	312	01454-N5061	22292	44	01553-09001	20671	476
000-990-57-92	20642	481	002-988-05-42	25038	777			58, 92, 102			515, 795
		515, 773	002-988-51-81	20897	770	01466-00261	25258	59	01553-09131	22897	491
000-990-84-92	21037	525	002-990-53-50	22780	689			92, 103			522, 730, 787
		576, 775			778	01552-00661	21999	802	01553-09241	19246	544
000-991-01-98	22309	494	002-997-33-86	18302	450	01553 00542	23700	494			573, 799
		520, 775			512, 672, 703			522, 797	01553-09311	19684	472
000-991-21-95	25058	569	002-997-33-86-67	18302	450	01553-00042	23700	494			514, 798
		580, 778			512, 672, 703			522, 797	01553-09321	19274	551
000-991-24-98	22899	486	002-998-16-50	25081	778	01553-00051	14356	479			573, 800
		522, 774	002-998-17-01	25040	772			510, 795	01553-09431	21134	555
000-991-28-95	22900	451			773	01553-00172	14737	475			576, 800
		522	003-80-14348	21659	780			510, 795, 831	01553-09611	20349	542
000-991-39-40	25216	555	003-988-41-78	20188	505	01553-00202	14347	478			575, 666, 755, 799, 842
		580, 777			514, 773			510, 795, 832	01553-09791	20668	496
000-991-41-40	22901	776	003-990-02-51	21431	688	01553-00291	14355	474			515, 730, 797
000-991-43-71	25116	770			778			510, 794	01553-10051	19905	550
000-991-44-71	25039	770	003-990-24-97	21184	353	01553-0034U	17350	556			573, 800
000-991-47-95	25059	773	003-990-35-97	22122	356			572, 714, 801	01553-10481	22832	502
000-991-49-40	22306	552	003-990-94-97	20971	351	01553-0038U	21311	542			731, 797
		579, 776	003-994-30-45	13218	112			577, 799	01553-10501	20349	542
000-991-52-40	14992	534			690, 779	01553-00401	14355	474			575, 666, 755, 799, 842
		571, 637, 655	003-994-75-45	22951	772			510, 794	01553-10611	23989	498
000-991-59-32	22265	358	003-998-13-50	22921	778	01553-0052U	20671	476			522, 731, 797
000-991-59-40	21711	526	004-988-76-78	20657	770			515, 795	01553-10641	22288	502
		578, 775	004-988-77-78	20657	770	01553-00541	23737	474			520, 731
000-991-63-98	22252	482	004-990-16-97	21286	358			522, 794	01553-10721	21192	553
		520, 774	006-988-43-78	22236	482	01553-00542	23700	494			577, 731, 767, 800
000-991-63-98-64	22252	482			520, 774			522, 797	01553-1JA0A	21229	471
		520, 774	007-603-006-106	23911	118	01553-00545	17452	475			516, 730, 794
000-991-63-98-M2222252	482	520, 774	007-603-010-103	23914	118			511, 795	01553-2DR9A	22039	553
		506	007-603-010-107	23915	118	01553-00755	16784	542			578, 731, 799
000-991-71-71	20253	514, 684, 775	007-603-01-21-02	24330	306			572, 799, 842	01553-2U001	21824	729
		771	007-603-012-104	23926	118	01553-0075U	18948	451			791
000-991-72-98	22922	479	007-603-01-21-06	24330	306			512, 795	01553-30001	22237	496
000-991-74-98	22254	520, 773	007-603-014-100	23927	118	01553-01121	17452	475			520, 797
		493	007-603-014-102	23918	118			511, 795	01553-S3500	13945	506
000-991-86-98	25215	523, 774	007-603-014-104	19621	306	01553-01182	20256	452			509, 798
		493	007-603-014-104	23442	118			514, 796	01553-S3500A	13945	506
000-991-89-98	25032	522, 773	007-603-014-106	20454	307	01553-01393	16843	569			509, 798
		770	007-603-016-102	23928	118			572, 768, 801	01651-00481	14695	700
000-991-90-98	22902	532	007-603-016-105	14871	118	01553-0162U	22572	500			761, 782, 790, 826
000-991-92-40	25335	580, 776	007-603-018-101	23919	118			521	01651-00491	22831	791
		111	007-603-020-100	23929							

O.E.M. INTERCHANGE BY NUMERICAL ORDER

OEM No.	Auveco No.	Page No.	OEM No.	Auveco No.	Page No.	OEM No.	Auveco No.	Page No.	OEM No.	Auveco No.	Page No.
07-11-9-904-288	24172	44, 92	07-14-7-443-710	22860	494, 684	10120517	23833	42, 90	10297369	20521	594
07-11-9-905-468	87506	290	07-14-7-460-560	25316	493, 523	10121502	11130	465, 509	10297370	20825	594
07-11-9-916-946	23847	44, 91	07-14-9-126-885	25317	44, 58, 92, 101	10121502	11146	457, 509	10297371	19379	594
07-11-9-963-029	23911	118	07-14-9-126-886	25397	44, 57, 92, 102	10121502	15414	457, 510	10298115	19486	582
07-11-9-963-106	23915	118	07-14-9-213-164	25202	44, 58, 101	10125439	16864	353	10299660	19449	469, 513
07-11-9-963-155	23926	118	07-14-9-248-255	25398	681	10126901	15669	506, 511	10300287	20353	594
07-11-9-963-200	23927	118	08540-61608	19170	44, 59, 92, 103	10131511	18461	351	10301966	20365	543, 605
07-11-9-963-201	23918	118	09148-05035	19505	827	10134407	18030	539, 572, 658	10305191	20814	491, 515
07-11-9-963-253	14871	118	09409-04304	14367	449, 510, 762	10139822	14991	539, 571, 600, 638	10308019	20521	594
07-11-9-963-300	24325	306	09409-05309-5ES	23962	522, 816	10140480	16835	560, 572, 601, 656	10323057	20607	592
07-11-9-963-308	23919	118	09409-07303-5ES	19128	550, 573, 844	10143422	17102	488, 511	10350983	21346	488, 517
07-11-9-963-342	23910	118	09409-07308	17162	532, 572, 601, 841	10146315	20177	455, 514	10351052	21347	584
07-12-9-901-645	13223	111, 690, 779	09409-073085PK	17162	532, 572, 601, 841	10153057	16695	491, 511	10351666	BH9	292
07-12-9-901-651	13218	112, 690, 779	09409-07313	17383	526, 572, 601, 816, 840	10155743	23833	42, 90	10352798	20973	591
07-12-9-904-150	22114	112, 690	09409-07332	20908	551, 576, 816, 844	10157900	16622	546, 571, 605	10352799	19757	591
07-12-9-904-223	25315	112	09409-08320	19257	499, 513, 754, 838	10158124	18175	488, 511	10352799	20808	591
07-12-9-904-224	13218	112, 690, 779	09409-08327	22083	535, 578, 816	1016078-00-A	20765	502, 515, 666	10352803	19800	591
07-12-9-925-708	13223	111, 690, 779	OG032-50037-A	21146	542, 577, 739	10160960	18935	356	10352809	20775	591
07-12-9-925-720	13162	114, 690	OK95A-68401	22312	494, 520, 738	10161937	12669	116, 151	10352810	19800	591
07-12-9-925-737	13218	112, 690, 779	OK95A-68615	21372	740	10169777	20344	450, 515	10363352	21177	596
07-13-0-702-516	21137	491, 516, 781	OWX68XDB-AA	21427	561, 577, 657	10169998	23833	42, 90	10363811	20634	489, 515
07-13-0-702-715	20570	110, 717, 781	10003294	12919	172	10182300	23884	458, 522	10369649	21240	493, 516
07-13-0-702-966	17267	556, 572, 676	10003617	12927	172	10184895	13751	342	10382313	21176	563, 577
07-13-0-702-966	17267	556, 572, 676	10004121	12943	173	10184895	13751	342	10383817	21157	597
07-13-1-480-419	21709	780	10008002	8814	148	10185925	18301	455, 512	10384814	20950	596
07-13-2-757-821	21659	780	10009923	12259	110	10195515	14995	528, 571, 600, 637, 655	10403591	19449	469, 513
07-13-7-073-915	21527	780	10013764	11352	613	10201332	19514	353	10405030	19368	470, 513
07-14-3-448-498	18156	64, 65	10014363	12997	139	10202466	18170	359	10408480	19527	490, 513
07-14-6-949-380	25264	689	10017487	12931	171	10207146	17226	535, 572, 604	10410398	19220	618
07-14-6-951-655	25342	111, 689	10017615	14677	315	10211824	10831	457, 509	10416890	19757	591
07-14-6-962-771	22285	495, 520, 781	10018202	12695	129	10212112	18749	355	10421018	20338	491, 515
07-14-6-963-883	22110	44, 55, 92, 99	10027015	17230	584	10212112	18749	355	10423331	19783	631, 747, 825
07-14-6-974-274	22786	681	10031004	18014	286	10220168	18688	462, 512	10423332	19783	631, 747, 825
07-14-6-974-274	22786	681	10032838	12713	585, 650, 807	10229437	18680	462, 512	10423553	20481	594
07-14-6-976-114	22298	681	10036503	14023	341	10237960	19220	618	10425306	20365	543, 575, 605
07-14-6-981-767	22260	861	10040001	9282	328	10241518	18688	462, 512	10426887	20775	591
07-14-7-122-912	22086	508, 519, 683	10041588	14527	147	10242285	20521	594	10431503	20775	591
07-14-7-122-913	21854	508, 519, 682	10051034	15467	439	10242316	18680	462, 512	10431524	19757	591
07-14-7-129-160	22030	44, 55, 91, 99	10053182	14997	534, 571, 600	10246149	19788	526, 573, 600	10431761	19821	596
07-14-7-129-161	22030	44, 55, 91, 99	10053388	15045	566, 571, 608	1025401-00-A	21169	503, 516, 544, 666, 667, 711	10437563	19800	591
07-14-7-129-161	22030	44, 55, 91, 99	10062	12253	107	10262036	18684	449, 512	10437565	19800	591
07-14-7-133-419	22793	560, 684	10062367	16695	491, 511	10278936	17654	343	10442914	20353	594
07-14-7-146-367	25394	21, 44, 57, 92, 102	10063599	18683	449, 512	10280874	18680	462, 512	10443956	20328	592
07-14-7-151-963	25395	21, 44, 57, 92, 101	1006521-00-A	20349	542, 575, 666, 755, 799, 842	10280874	18680	462, 512	10445899	21504	594
07-14-7-154-227	25396	21, 689, 778	1006535-00-A	19453	574, 666	10281487	20395	618	1047307-00-A	21822	498, 519, 806, 838
07-14-7-169-847	22780	689, 778	10073833	12992	507, 509	1028285	20521	594	10476561	9282	328
07-14-7-201-307	22084	681	10077283	15042	571	10242316	18680	462, 512	106212	14335	782, 790
07-14-7-212-877	22822	690	10078274	18897	451, 512	10246149	19788	526, 573, 600	106653	12543	213
07-14-7-213-303	22781	541, 686	1008068	21853	485, 519, 742, 855	1025401-00-A	21169	503, 516, 544, 666, 667, 711	1067906-00-A	12119	110, 667
07-14-7-236-400	25094	682	10084751	19644	153	10262036	18684	449, 512	10708	12522	129, 130
07-14-7-265-039	22952	681, 780	10089262	14987	526, 571, 599, 655	10278936	17654	343	10709	12520	129, 130
07-14-7-265-039	22952	681, 780	10098645	18682	452, 512	10280874	18680	462, 512	10998-30880	14696	531, 570, 713, 733, 798
07-14-7-281-961	22848	563, 686	10108746	16625	557, 571, 606	10280874	18680	462, 512	11026-01M02	21258	309
07-14-7-293-278	22146	691	1010919-00-A	19506	452, 513, 672, 704	10281487	20395	618	11026-61000	24299	309
07-14-7-296-886	22509	467, 521, 682	10109689	15490	342	10283414	19368	470, 513	11026-JA00A	21258	309
07-14-7-311-312	22847	111, 690	10116-41810	23738	530, 580, 841	10285935	20338	491, 515	11056321	24281	330
07-14-7-336-362	22787	688	1011813-00-A	20633	497, 515, 666, 838	10285935	20338	491, 515	11126AA000	19139	309
07-14-7-378-241	22917	342, 691	1011978-00-A	25285	355, 359, 667	10287935	20338	491, 515	11128-01M0B	21293	313
07-14-7-391-323	22144	691				10287937	20261	81, 87	11128-69220	15528	318
07-14-7-391-324	22131	691				10287547	20408	589	11128-U8000	15528	318
07-14-7-401-727	22894	553, 580, 686				10287926	20232	437, 588	11-13-1-250-089	24248	313
						10287971	19275	490, 513	11-13-1-273-093	24248	313
						10293193	20893	450, 516	11-13-7-553-918	24248	313
						10293674	19149	451, 513	11-13-7-585-928	24235	318
									11-13-7-605-018	22344	320, 534, 579, 603
									111-997-03-30	18026	318
									111-997-03-30-64	18026	318
									11254-06203	22296	45, 62, 93, 105
									11254-06206	22296	45, 62, 93, 105
									11296-3TA0A	22198	804
									11296-AG000	20953	553, 576, 731, 800

O.E.M. INTERCHANGE BY NUMERICAL ORDER

OEM No.	Auveco No.	Page No.	OEM No.	Auveco No.	Page No.	OEM No.	Auveco No.	Page No.	OEM No.	Auveco No.	Page No.
1135147-00-A	25153	666	11502770	10171	19	11504536	13002	140	11516077	11708	108
1135147-S0-B	25153	666	11502790	11935	81	11504565	13619	81	11516148	18477	287
113-857-219A	13206	853			87			89	11516149	12667	117
114-997-02-90	20655	299	11502794	12118	110	11504567	13614	81			152
		779	11502811	11709	108			88	11516150	11630	117
11500086	12350	45	11502812	11708	108	11504570	12067	80			152
		62, 93, 105	11502941	12693	80			84	11516150	12667	117
11500401	15335	109			84	11504614	15327	109			152
11500421	2775	22	11503317	11630	117	11504654	23698	91	11516152	18339	117
11500434	15373	43			152	11504659	2709	19			153
		51, 91, 97	11503394	12740	42	11504693	11626	116	11516372	20416	116
11500654	18337	116			49, 90, 95			150			152
		149	11503395	12741	42	11504978	12666	116	11516397	20339	116
11500655	11625	116			50, 90, 95			152			149
		149	11503396	12742	43	11504981	12068	45	11516440	3079	21
11500656	18338	116			51, 90, 96	11504982	12343	61, 93, 104	11516596	13705	81
		150	11503412	24173	93			89			89
11500657	11626	116	11503421	12213	22	11505005	12596	109	11516656	20935	594
		150			42, 48	11505022	12351	45	11516780	15335	109
11500658	11628	117	11503432	12117	107			60, 93, 104	11516780	23656	109
		152	11503455	12667	117	11505023	12339	45	11516807	20741	355
11500660	11629	117			152			60, 93, 104	11516811	13755	341
		152	11503483	12742	43	11505044	18416	81	11516936	18927	354
11500661	11630	117			51, 90, 96			87	11516942	13619	81
		152	11503499	23841	42	11505104	13712	42			89
11500662	11631	117			90			49, 90, 95	11517071	11708	108
		153	11503503	12097	43	11505209	13618	81	11517079	22579	116
11500663	18339	117			51, 90, 96			87			151
		153	11503578	18261	42	11505326	15790	81	11517293	12596	109
11500754	11935	81			50, 90, 95, 96			88	11517343	12065	80
		87	11503619	13613	81	11505329	12595	109			86
11500754	23661	81			88			862	11517517	12324	80
1150086	12350	45	11503632	12336	81	11505329	23684	109			84
		62, 93, 105			88	11505596	18338	116	11517700	19449	469
11500970	12336	81	11503636	12213	22			150			513
		88			42, 48	11505816	23801	80	11517706	13619	81
11500971	12348	81			81			80			89
		88	11503668	13705	81	11506117	15335	109	11517769	23461	617
11500994	12057	44			89	11506174	12693	80	11517803	16622	546
		59, 92, 103	11503695	15335	109			84			571, 605
11500996	12339	45	11503698	12124	110	11508023	12322	80	11517841	25077	116
		60, 93, 104			116			84	11517873	20452	585
11500997	12354	45	11503714	11864	151	11508241	12575	117	11517996	11708	108
		61, 93, 104			152			152	11518017	20632	559
11501102	13613	81	11503715	12575	117	11508269	13614	81			575, 607
		88			152			88	11518201	20281	461
11501105	11633	81	11503716	11864	116	11508275	15330	109			514
		87			151	11508430	12339	45	11518357	20328	592
11501152	13613	81	11503719	18449	116			60, 93, 104	11518357	20377	592
		88			151	11508827	23809	42	11518377	24265	315
11501188	13614	81	11503736	14980	110			90	11518531	21027	616
		88	11503752	12595	109	11508900	12253	107	11518684	20415	618
11501193	11641	81			862	11508927	13002	140			646
		89	11503754	12596	109	11508930	15791	80	11518908	20395	618
11501194	13620	89	11503756	12596	109			84	11518937	22117	617
11501794	12739	42	11503785	18261	42	11509005	18449	116	11518988	21036	595
		47, 90, 95			50, 90, 95, 96			151	11519023	21286	358
11501800	15334	109	11503800	12324	80	11509189	12350	45	11519030	2189	504
11501835	12253	107			84			62, 93, 105			516
11501836	12255	107	11503812	12064	80	11509371	12057	44	11519031	20616	503
11501849	12260	110			84			59, 92, 103			515
11501883	12059	42	11503815	12322	80	11509374	12741	42	11519031	21379	503
		46, 48, 90, 94			84			50, 90, 95			517
11501884	12060	43	11503823	12693	80	11509511	11639	81	11519032	21189	504
		51, 90, 96			84			88			516
11501889	11644	107	11503825	13618	81	11509535	15711	107	11519069	25183	614
11501896	12061	42			87	11509589	11638	81	11519408	21047	314
		46, 49, 90, 94, 95	11503833	15788	80			87	11519444	20359	547
11501903	12062	42			86	11509816	12067	80			575, 605
		47, 90, 94	11503834	12065	80			84	11519444	20631	547
11501932	12253	107			86	11509932	12253	107			575, 606
11501937	12119	110	11503892	15373	43	11510062	12253	107	11519807	18896	560
		667			51, 91, 97	11513599	20339	116			573, 607
11502449	15373	43	11503941	13617	80			149	11519818	19783	631
		51, 91, 97			85	11513599	21040	116			747, 825
11502483	12097	43	11503957	11864	116			149	11519949	19239	552
		51, 90, 96			151	11513798	20600	288			580, 606, 675,
11502504	12125	110	11503957	12669	116			292			711, 756, 785
11502507	15711	107			151	11513801	12738	43	11519952	20422	618
11502540	12115	107	11503982	12066	80			51, 90, 96	11519960	20423	618
11502605	11639	81			86	11513864	12064	84	1151A-78J00	24265	315
		88	11504047	16842	116			84	11546343	22451	352
11502607	23711	81			151	11514282	15711	107	11546449	22947	109
11502617	11629	117	11504056	12738	43	11514290	10067	147	11546459	15335	109
		152			51, 90, 96	11514343	11639	81	11546588	22240	482
11502618	22164	80	11504119	16980	110			88			520
		83	11504230	1943	21	11514623	12067	80	11546635	22036	593
11502618	22164	80	11504288	12667	117			84	11546805	22071	479
		83			152	11515478	12575	117			519
11502624	11639	81	11504303	23689	80			152	11546850	22267	499
		88			86	11515638	22074	116			520
11502630	23794	42	11504492	12348	81			149	11546868	22874	629
		90			88	11515756	11639	81	11546963	22278	485
11502737	12127	110	11504493	12323	80			88			520
11502759	12126	110			86	11515757	13614	81	11546964	22279	485
		110	11504531	9879	146			88			520

O.E.M. INTERCHANGE BY NUMERICAL ORDER

OEM No.	Auveco No.	Page No.	OEM No.	Auveco No.	Page No.	OEM No.	Auveco No.	Page No.	OEM No.	Auveco No.	Page No.
11547024	22276	591	11569973	20891	597	11603264	25249	492	12010293	18326	190
11547026	22167	591	1156A	B1156A	290			523	12010300	15955	190
11547047	22259	487, 520	1156NA	17597	286	11609292	22035	618	12010717	15953	188
		589	11570015	22538	617	11609317	20422	618	12010974	18146	188
11547077	25271	589	11570082	13614	81, 88	11609385	12575	117, 152	12010975	18152	189
11547155	25190	614							12010996	15949	188
11547210	22029	594	11570498	22946	43, 52	11609411	12596	109	12012000	14884	197
11547211	22258	593				11609411	23685	109	12013813	13543	216
11547339	22228	587	11570498	22946	43, 52	11609417	20826	548, 576, 606	12014012	14462	189
11547341	21835	652							12014254	20751	198
11547341	22846	589	11570612	25273	615	11609457	22550	42, 46, 48, 51, 90, 94, 96	12014836	14153	190
11547420	22946	43, 52	11570637	22070	43, 52, 91, 97				12014837	14154	190
						11609483	21377	610	12015024	18148	188
11547446	22277	617	11570654	22289	616, 644, 663	11609535	20527	586	120151	12546	213
11547574	21488	482, 517				11609536	20529	586	12015193	20618	190
			11570768	25007	46, 94	11609624	19220	618	12015323	14152	190
11547577	22240	482, 520				11609651	21745	615, 646, 663, 740, 816	12015631	19795	298, 611
11547581	22492	593	11570830	21674	585	11609738	14980	110	12015791	15950	188
11547582	22491	617	11570846	21370	595	11609740	21667	595	12015792	15952	188
11547601	22278	485, 520	11570847	22027	594	11609762	22081	43, 53, 91, 97	12015793	15954	188
			11570951	23985	63, 65				12015797	18145	188
11547602	22279	485, 520	11571016	25274	615	11609836	22121	618	12015798	18147	188
			11571063	25343	508, 523	11609862	20938	584	12015799	18151	188
11547637	22953	610				11609923	21667	595	12015857	14881	192
11548298	22579	116, 151	11571109	23993	557	11609952	21027	616	12015858	20216	193
			11571118	21535	489, 518	11609952	21754	616	12015861	15938	194
11548579	22582	149	11571119	21536	489, 518	11609989	12065	80, 86	12015862	15948	189
11548580	22583	116, 149				11610086	15543	458, 510	12015870	15945	194
			11571159	21443	464, 517				12015878	17002	192
11548585	22838	117, 152				11610086	15543	458, 510	12015899	20749	190
			11571175	20934	593	11610157	21524	616	12015917	18324	189
11548586	22699	153	11571175	21242	593	11610198	20529	586	12020116	14880	192
			11571175	21374	593, 654	11610210	21114	349	12020120	15939	194
11548673	22886	616				11610245	17427	346	12020126	15944	194
11548932	25271	589	11571225	22911	584	11610271	3079	21	12020320	11948	191
11549307	22839	486	1157A	B1157A	290	11610383	21124	357	12020321	18650	191
11561143	12127	110	1157NA	16901	286	11610495	21793	593	12020347	15935	191
11561329	21200	595	11588308	18461	351	11610522	21157	597	12020757	14883	190
11561334	22266	357	11588308	21327	341	11610544	22410	617	12020801	20748	189
11561349	20766	556, 576, 659	11588415	18337	116, 149	11610605	21488	482, 517	12020801	18923	218
						11610606	21489	485, 517	1202133	17463	221
11561353	14998	560, 571, 601	11588441	21351	619				12033674	14150	189
			11588650	20883	615	11610700	25180	590	12033817	15960	191
11561368	20888	546, 576, 605, 658	11588863	20944	488, 516	11610705	20938	584	12034046	15947	193
						11610747	21301	460, 517	12034051	15946	192
11561448	18153	616	11588988	20631	547, 575, 606	11610748	21302	611	12034342	14151	189
11561448	24179	616				11611100	21672	545, 578, 605	12040902	18149	188
11561491	20884	596	11589012	22724	43, 91, 98				12040983	15924	190
11561499	21383	489, 517				11611321	22581	116, 151		19851	298, 612
11561500	21384	586	11589015	12738	43, 51, 90, 96				12041351	20618	190
11561509	20261	81, 87	11589031	22536	80, 85	11611342	22533	470	12043215	16694	217, 242, 276
			11589111	21439	354	11611367	22268	591			
11561654	21333	502, 517	11589176	20972	592	11611375	21825	590	12045234	15927	211
			11589181	21199	453, 516	11611435	21827	596	12045236	15926	211
11561655	20938	584				11611626	21739	597	12045773	18653	191
11561740	19644	153	11589244	20891	597	11611651	22173	351	12046623	23016	234, 257
11561838	12253	107	11589289	20988	544, 576, 605, 658	11611664	25050	470, 522			
11561874	21361	564, 577, 609, 801	11589290	13996	540, 570, 604				12046624	16693	232, 256
						11611677	22233	465	12047581	15498	191
11561987	21518	586	11589290	14007	539, 570, 602, 657	11611822	21488	482, 517	12047680	15497	191
11562026	23888	645	11589290	14753	540, 571, 601, 638, 656	11611838	22277	617	12047767	15499	191
11562043	20995	489, 516	11589290	20880	545, 576, 605	11611882	22945	50	12048074	18654	191
						11612034	25221	611	12048369	14918	217, 242, 276
11562044	20996	489, 516	11589291	20989	546, 576, 605, 641	11612035	20991	557, 576, 607	12051234	14580	232
									12052922	16806	191
11562250	21242	593	11589291	20991	557, 576, 607	11612035	22100	553, 578, 606	12065158	18150	188
11562256	20998	489, 516	11589292	20991	557, 576, 607				12066214	14881	192
						11612122	22036	593	12066614	20231	194
11562257	20999	489, 515	11589293	20889	558, 576, 607, 641	11612177	12125	110	12076946	17175	217
						1165051	19626	864	12083005	16585	217
11562288	23553	489, 522	11589294	20992	559, 576, 607	1165051	19627	864	12083006	16586	217
						117971	4417	424	12083460	18924	218
11562364	21187	613	11589295	20993	564, 576, 608, 642	119005	16897	288	12083680	17172	217
11562503	21753	616	11589296	20994	564, 576	1196781	3682	71	12083689	17173	217
11562563	21128	592				11998	24317	306	12084595	15948	189
11562568	22034	504, 519	11589329	25275	614, 663	12001470	13549	216	12084912	20209	194
						12003757	13546	216	12084913	20210	194
11562588	21047	314	11601845	25181	595	12003758	13545	216	12085270	20752	198
11569618	20423	618	11602471	25276	615	12003759	12600	216, 267	12085330	17174	217
11569697	21161	596	11602522	22994	480, 521				12085485	19882	237, 257, 262
11569700	22031	503, 519				12003878	13544	216			
			11603057	25416	615	12004005	12536	213	12085485	23181	222
11569768	11146	457, 509	11603260	25085	480, 522	12004009	12540	213	235, 240, 248, 259, 266		
						12004010	16359	213	12085487	23157	229
11569810	25272	502				12004188	19199	205			
11569917	20423	618	11603262	25247	490, 523	12004201	8775	190	12085490	16968	221
11569917	22121	618				12004311	12237	215, 241			
11569918	21129	594							12085491	16968	221, 248, 269, 277
11569920	21158	590	11603263	25248	490, 523	12010085	15948	189			
11569921	22803	597				12010182	15937	189			
11569971	25045	117, 153									

O.E.M. INTERCHANGE BY NUMERICAL ORDER

OEM No.	Auveco No.	Page No.	OEM No.	Auveco No.	Page No.	OEM No.	Auveco No.	Page No.	OEM No.	Auveco No.	Page No.
12085491	23032	222	12102757	19555	237	12337898	17341	439	13-3026-L	15010	130
	248, 269, 277		12102763	23260	230,	12337915	15490	342	13435002	25421	590
12085492	23026	234			240	12337916	15783	38,	13475541	22576	459,
12085495	18868	233	12103360	20230	194			40			515
12085496	17114	221	12103381	15497	191	12337917	12669	116,	13500802	16694	217,
12085497	18524	232	12110250	23071	229,			151			242, 276
12085498	16694	217,		254, 272, 278		12337920	12737	506,	13503359	B194	290
		242, 276	12110842	20217	193			509	13503360	B921	290
12085500	23254	240	12110843	20219	194	12337966	11630	117,	13503401	16902	286
12085501	23081	231	12110844	20218	193			152	13503401	20285	287
12085502	16964	232	12110845	20222	193	12338011	15467	439	13503418	BH13	292
12085503	16514	224	12110846	20225	194	12338015	17437	624	1351769	9112	165
12085503	23018	225	12110847	20224	193	12338025	13009	140	1355003	9069	584
12085506	18918	221	12112171	13644	237,	12338034	15453	431	13579188	22887	287
12085521	23017	225			261	12338074	16936	624	13579188	B7443	290
12085524	23147	235,	12116257	23145	235	12338089	12594	587	13579198	B7440	290
		284	12116958	17111	227	12338096	12824	588	13579204	BH11	292
12085525	17109	223	12117260	14918	217,	12338100	15518	620	13584255	21220	218,
12085526	17109	223			242, 276	12338114	9112	165			276
12085527	17109	223	12117277	23050	229	12338123	2775	22	13584433	17112	226,
12085528	17109	223	12117333	23035	219	12338146	10052	148			253
12085533	17199	228	12117361	17109	223	12338153	11621	347	13585316	18868	233
12085535	23256	221,	12117367	11439	215,	12353912	15463	438	13585849	23211	224
		230			241, 281	12354949	11083	205	13585860	23221	223
12085537	23124	224,	12117367	23142	282	12354969	15948	189	13586114	17110	232,
		235, 239	12117369	22931	219	12354970	15937	189			254, 256
12085538	18917	233	12117384	13547	223	12355104	9481	187	13586977	BH11	292
12085539	23252	240	12117385	17107	232	12355107	14150	189	13589425	B9005	291
12089040	14150	189	12117387	18145	188	12355107	14153	190	13590791	B880	291
12089188	14151	189	12124075	20214	191	12375975	22453	620	13591403	B7443	290
12089189	13659	182	12124076	20215	191	12384935	24285	330	13591404	B7443	290
12089190	13669	182	12124304	15938	194	123-990-00-92	20636	527,	13596816	B7440	290
12089191	13678	182	12124515	8774	192			575, 776	13-6005	15018	131
12089191	19262	182	12124580	15937	189	123-990-02-92	20637	551,	1370853	12735	583,
12089305	15948	189	12124581	18324	189			575, 776			649, 851
12089306	18325	189	12124582	15948	189	123996-0	24304	309	1377030	10365	585
12089307	20747	189	12124587	18325	189	1244839	9965	598,	13-8004	15015	130
12089340	16806	191	12125637	11440	231,			864	1395-68-676	14369	550,
12089649	14883	190			272	12450053	18001	286			570, 767
12092075	16360	213	12125641	25211	230	12450176	20595	288	1395-68-676-00	14369	550,
12092080	16355	213	12125649	22770	233,	1247872	15459	619			570, 767
12092081	16354	213			237	1247872	15459	619	14002811	13002	140
12092344	20226	193	12126012	23187	285	12493-05167B	18340	43,	14003784	16986	37,
12092345	20227	193	12126032	22771	231,			54, 91, 99			106
12094429	20583	197			255, 272	12493-05167B	18340	43,	14004876	12931	171
12101855	18870	233,	12126451	18674	232	12493-05167-B	18340	54, 91, 99	14005097	16248	140
		253, 256	12126452	15952	188			54, 91, 99	14005953	14977	38,
12101856	18320	221	12126453	22772	218,	12493-06207-B	22295	45,			40, 139
12101858	23221	223			228, 238			61, 105	14007510	13231	38,
12101869	18151	188	12126458	22932	228,	12493-06207-B	22295	45,			39, 139
12101871	23259	231			233			61, 105	14007510	13232	38,
12101879	13559	216,	12126469	23016	234,	12493-06257-E	25409	44,	14007511	14976	39, 139
		241, 267			257			56, 92, 100			38,
12101880	18867	226,	12126470	16967	220,	12493-06257-E	25409	44,			39, 139
		253			227, 284			56, 92, 100	14007940	12999	139
12101881	23210	231	12126473	18527	232,	124-988-90-78	22115	779	14008227	12210	171,
12101888	23265	230			256	124-990-04-92	20909	537,			433
12101895	17109	223	12126487	17112	226,			576, 776	14011722	11109	38,
12101896	23079	226			253	124-990-05-92-905120640		527,			41
12101897	16174	217,	12126543	23009	238			575, 775	14011819	23736	625
		242, 267, 276	12129373	20213	191	124-990-07-92	20203	568,	14013246	13960	583
12101898	16175	217,	12129409	20223	193			575, 777	14017701	12930	171
		242, 268, 276	12129484	20212	191	124-990-07-92-9C7520203		568,	14017705	12923	171
12101899	23016	234,	12129493	18658	192			575, 777	14017779	12947	173
		257	12129497	18659	192	12530252	17654	343	14017780	12924	172
12101903	17690	237	12141301	23130	219	12531204	23970	353	14019205	12567	539,
12101906	16967	220,	12141302	23131	220	12531209	19441	635			570, 602, 657
		227, 284	12141388	23127	219,	12531210	19441	635	14019205	14007	539,
12101907	23146	225			276	12533567	17103	534,			570, 602, 657
12101909	13548	223	12141493	23132	220			572, 603, 640	14019206	14007	539,
12101914	23038	228	12157-10010	21116	309	1254815	11838	583			570, 602, 657
12101917	13686	211	12159662	17172	217	1255/H3	20600	288	14019225	14007	539,
12101922	23184	231	12160374	20665	298,	1257702	14217	612,			570, 602, 657
12101923	23264	285			612			643, 665	14019226	14011	537,
12101927	23065	239	12160857	20514	612	12580254	24356	303			570, 602
12101937	17113	224	12160858	20397	298,	1264963	12713	585,	14023108	12925	172
12101939	18871	231			611			650, 807	14025274	12916	172
12102491	23081	231	12167120	23190	220,	1268176	19248	536,	14027471	12759	462,
12102568	17463	221			230, 235			573, 863			509
12102601	23012	228	12167121	18867	226,	1268176-3	19248	536,	14027775	20799	432
12102620	16693	232,			253			573, 863	14027776	20800	432
		256	12167658	23275	227	126-994-13-45	13215	112,	14029095	12940	173
12102621	14580	232	12176839	23089	298,			690, 779	14031114	12926	172
12102664	21490	218,			612	12713651	24295	312	14031114	23391	172
	237, 243, 263, 268, 274		12176844	19853	612	127934	16910	286	14031144	12916	172
12102675	23158	225	12186456	20220	193	1304225	4249	430	14031145	12932	173
12102696	23196	231,	12186457	20221	193	131282	16914	286	14032200	14008	569,
		255, 272	12187091	17111	227	13144822	21541	44,			570
12102747	17110	232,	12191645	16351	213			58, 92, 103	14032291	14009	585
		254, 256	12291-06303	22757	64,	13235-A	8763	241	14037239	18926	620
12102748	18527	232,			67, 86	13252118	21365	482,	14039261	23789	80
		256	12337831	20892	56						

O.E.M. INTERCHANGE BY NUMERICAL ORDER

OEM No.	Auveco No.	Page No.	OEM No.	Auveco No.	Page No.	OEM No.	Auveco No.	Page No.	OEM No.	Auveco No.	Page No.
14045480	14010	564, 570, 602, 657	15221959	20865	592	15672183	19782	623	15964972	16937	625
14047034	12929	171	152266	8375	148	15672328	17599	508, 511	15967691	19424	623
14048060	13005	140	152267	8372	148				15969147	17216	557
14051674	15518	620	152273	15677	148	15672330	14998	560, 571, 601		572, 606, 641	659
14063981	13750	342	15236893	20951	596				15975244	19834	459
14066728	17437	624	15236894	20952	592	15672713	18167	347			514
14070914	13749	341	15265199	25051	586	15678493	17215	465, 511	15985762	23866	439
14071289	14011	537, 570, 602	15282120	20935	594				15986343	18371	456
			15284612	20529	586	15678979	18948	451, 512, 795			512
14074081	14036	456, 510	15288146	20885	593				15986673	19356	490
			15289020	20527	586	15679091	14953	568, 571, 598, 636	15989431	21380	513
14078435	11852	346	15296830	20990	548, 576, 606, 659	15681408	17103	534, 572, 603, 640	15990756	18030	517
14082956	18817	42, 49, 90, 95	15300530	19882	237, 257, 262						539
						15682898	18262	616			572, 658
14083173	14820	617, 644	15304-9	23918	118	15683327	21387	613	15993201	16622	546
			15305801	23268	236	15685040	19424	623			571, 605
14090382	19278	43, 52, 91, 97	15305874	22773	218, 224, 228, 238	15685099	20415	618, 646	15994165	20542	537
											575, 604
14090908	16026	302	15305887	23261	240	15686047	15792	38, 40	1600375	10759	581
14090908	24343	302	15305925	23262	240				1600375	23310	581
14093088	14020	565, 570, 608	15305932	18524	232	15686142	18153	616	1605396	11146	457
			15305942	23053	226, 234	15690531	18744	342			509
14093311	10831	457, 509	15305960	23226	235	15691478	17216	557, 572, 606, 641, 659	1605396	15414	457
14093869	14980	110	15306002	23081	231	15691493	16936	624	1606642	11657	581
14101262	15702	565, 571, 608	15306009	23124	224, 235, 239	15691494	16937	625	1610403	12917	172
						15691595	19424	623	1611249	20364	43
14103026	12084	345	15306031	23016	234, 257	15694099	18391	489, 512	16-13-1-176-747	21431	688
14103438	15042	571	15306045	23054	231	15694193	16936	624			778
14103461	15043	607	15306086	23014	219	15704030	19515	354	16-13-6-753-087	22859	530
			15306087	23015	219	15705372	11246	581			580, 685, 781
14160-03103	22437	348	15306157	21006	218	15707256	19317	72, 617	1614858	12931	171
14160-03103	22437	348	15306189	23221	223				1617333	12919	172
14160-03130	25251	350	15306194	23131	220	15709521	18262	616	161-867-299-01C	19195	536
14160-03133	22481	349	15306195	23016	234, 257	15714775	11655	582			573, 858
14160-03133	22481	349				15714775	11871	582	1618890	11470	581
14160-05130	22436	353	15306302	17111	227	15715058	17654	343			665
14160-05130	22436	353	15306329	22934	232	15718794	13755	341	1618890	11657	581
14202-14120-B	25422	720	15306349	22774	222	15732202	18028	341	1618890	23309	581
14202-14120-B	25422	720	15306398	22775	218	15733970	19614	586	1619321	12137	462
14206-08250-B	22253	543, 579, 726, 739	15324824	23124	224, 235, 239	15733971	19613	586			509
						15737532	12520	129, 130	1619321	16263	462
14206-08250-B	22253	543, 579, 726, 739	15326410	19836	451, 514	15737533	12522	129, 130	1621253	12935	171
142451	20292	287	15328724	16352	213				1624705	2744	864
142452	16911	286	153297	16478	42	15745990	20527	586	1624705	12959	864
142453	18015	286				15745991	20529	586	1631564	15478	462
142454	16926	286	15502538	8931	339	15762170	14921	449, 510			510
142456	16923	286	15505451	16251	140				1635218	12999	139
145525	14388	296	15506827	14012	341	15762170	18302	450, 512, 672, 703	1636632	16624	538
1477728	5592	474, 509	1550971	18474	287						571, 604
			15516462	18749	355	15763285	14921	449, 510	1638575	19162	147
1480627	8359	148	15545178	18926	620	15769308	21290	619	1640810	15373	43
14910-04000	22564	721, 736	15545202	15670	507, 511	15772605	16908	286	1644290	18948	451
						15773445	14753	540, 571, 601, 638, 656	16500308	14016	512, 795
14910-04000	22564	721, 736	15562609	16937	625	15802005	21338	460, 517			570, 603, 657
			15567924	15459	619				16502342	20301	64
14910-05000	22300	722	15569071	20797	432	15822417	21474	211			67
14913-05000	21150	721	15569072	20798	432	15828918	18001	286	16503329	14002	583
14913-05000	21150	721	155-809-966	12735	583, 649, 851	15864780	22037	597	16510893	15676	583
14913-05010	21150	721				15864780	22803	597	16514113	23954	580
1494251	15677	148	15588024	13946	507, 509	15872008	20884	596			602
1494252	8359	148	15588078	14032	456, 510	15893516	20885	593	16517439	14021	450
1494253	10830	148				15924986	25052	610			510
1494254	10054	149	15591860	19424	623	15931605	21379	503, 517	16524326	18661	288
1494257	10051	148	15596279	14031	583				16524431	18662	288
1494258	8814	148	15596280	14037	585, 650	15944588	21248	460, 516	1654047	11345	437
15002520	18262	616							165-827-592	21480	851
15014352	20943	530, 576, 600	15596301	13946	507, 509	15953247	17649	507, 511	1660123	11717	587
			15598757	15792	38, 40	15953718	23866	439	16607593	14967	619
15015804	18889	357				15954398	19429	585			647, 662, 665
15029828	4369	430	15600382	12992	507, 509	15955172	13752	342	16629237	18393	619
15031239	17654	343				15955523	17654	343	16629990	19658	620
15033681	20860	614	1560058	19626	864	15956062	18169	353	16630688	21196	620
15035237	25193	586	1560058	19627	864	15956470	14998	560, 571, 601	16630689	21197	620
15040331	21290	619	15607165	15970	507, 511				16632193	16936	624
15045388	21195	434				15958694	11146	457, 509	16640343	19658	620
15056810	20362	461, 515	15612948	15970	507, 511	15959832	18268	566, 573, 609	16659130	20279	507
											514
15061964	21195	434	15614746	21028	341	15959833	18334	566, 573	16662182	19519	614
15076791	20444	503, 515	15614774	18244	354				16674629	20189	663, 666
			15622490	17615	349	15960325	18353	530, 573, 609			514
15078238	20860	614	15622490	23861	350				16675980	19658	620
15116576	20935	594	15638413	16938	490, 511	15960621	19355	529, 573, 603	16715497	17468	342
15127746	20934	593									352
15149708	19639	538, 573, 604, 640, 658	15641800	11110	38, 41	15963179	16938	490, 511	16723225	12084	345
									16723225	17427	346
15153415	19615	558, 573, 607	15647709	23856	439				16-7552	9481	187
			15648833	14988	526, 571, 637	15964853	13966	141, 807	16758	4248	429
15175428	12930	171				15964971	16936	624	16758A	4155	430
15203303	BH13	292	15650655	9880	146				1688094	11425	587
15209748	21106	211	15653790	19781	623						

O.E.M. INTERCHANGE BY NUMERICAL ORDER

OEM No.	Auveco No.	Page No.	OEM No.	Auveco No.	Page No.	OEM No.	Auveco No.	Page No.	OEM No.	Auveco No.	Page No.
1689827	12095	42, 48	19299324	20485	621	1U2Z-14S411-TA	20851	250	20455900	14006	450, 510
1699250	24181	455, 522	19299616	21220	218, 276	1U2Z-14S411-YA	21490	218, 276	20462090	16865	448, 597
17-11-1-712-963	22596	532, 579, 685	19300089	13659	182	1U5Z-13466-BB	16901	286	20465395	14005	341
171-201-969	21456	862	19300091	19262	182	1W1Z-19E889-HB	17604	423	20477732	16687	351
171-807-249-A	21494	505, 517, 856	19304003	23265	230	1W6Z-238A90-AA	20363	532, 575, 643	20477732	16687	351
1725489	21988	852	193065	18474	287	1W6Z-238A91-AA	20363	532, 575, 643	20478294	13860	610
1732326	12315	626	19326896	15948	189	20003056	20427	503, 515	20480475	13453	506, 509
1746408	18817	42, 49, 90, 95	19329253	17112	226, 222, 253	20030401	15457	465, 510	2048248	11673	461, 509
175720B010	14011	537, 570, 602	19329253	23020	222, 269	20032850	11679	453, 509	20487630	15463	438
1758099	2752	865	19329763	20485	621	20037240	23649	587, 625	20487631	17341	439
1758099	12960	865	19332887	22174	622	20037597	12314	625	20510029	13993	540, 640
175-820-435	16252	140	19352194	22088	352	20046147	14559	623	20511451	13454	453, 509
175-853-577	13748	341	19352782	20934	593	20046150	11816	597	20514862	15367	453, 510
175-853-577-01C	13748	341	19352782	21374	593, 654	20058837	18398	447, 597	20538173	18302	450, 512, 672, 703
175-853-577A	13753	342	19353806	21286	358	20064875	11130	465, 509	20547865	14147	565, 570, 608
175-867-299	13475	505, 509, 808, 856	19353806	21286	358	20064875	15456	465, 510	20551451	13454	453, 509
175-867-949	8418	72	19353809	25108	358	20085729	17073	440	20570245	13994	565, 570, 608, 642
179-813-881	14030	584, 851	19368868	21220	218, 276	20097200	12569	627, 649	2057A	B2057A	290
179-813-883	12735	583, 649, 851	194A	B194A	290	20099254	23742	625	2057NA	16908	286
17988488	14820	617, 644	1999366	16898	288	2011554	12084	345	20582532	18392	619
17997722	14820	617, 644	1999437	B9005	291	2011554	17427	346	20582533	18393	619
18642-21010	B9004	291	1999482	20620	287	20123070	15467	439	20585900	23079	226
18644-28087-L	B2357A	290	1999482	20620	287	20130258	13002	140	20590899	13996	540, 570, 604
18647-27009	B881	291	1999482	20620	287	20130258	13003	140	205-991-00-71	25034	770
18647-27009	B881	291	1999482	20620	287	20130258	23497	37	20603072	11152	436, 437
18647-55007L	BH7	292	1999482	20620	287	20160591	15466	439	20612732	13746	341
18647-55007L	BH7	292	1999482	20620	287	20162174	17176	439	20626174	19394	440
18647-55009E	BH1	292	1999482	20620	287	20171942	12594	587	20633148	18392	619
18647-55009E	BH1	292	1999482	20620	287	20173225	19817	434	20633149	18393	619
18649-55009	B9006	292	1999482	20620	287	20175051	12563	587	20633504	15463	438
18649-60556	18661	288	1999482	20620	287	20175890	23720	588	20635065	13994	565, 570, 608, 642
18649-60556-L	18661	288	1999482	20620	287	20184399	11621	347	20641977	18218	250
18649-65009	B9005	291	1999482	20620	287	201990-00-50	20645	778	2064891	10621	506, 509
18649-65559	B9007	292	1999482	20620	287	201990-02-92	20638	555, 575, 686, 777	2064891	10621	506, 509
18665-0	23915	118	1999482	20620	287	201990-05-36	21774	44, 56, 92, 100	2064891	16260	506, 511
18836-7	23914	118	1999482	20620	287	20199675	14642	588	20652520	18679	462, 512
18840-9	23919	118	1999482	20620	287	201997-22-81	20659	772	20664091	14753	540, 571, 601, 638, 656
1900654	9361	443	1999482	20620	287	20200750	18510	467, 512	20664092	14753	540, 571, 601, 638, 656
190-990-2	23911	118	1999482	20620	287	20227160	23907	522	20687704	16624	538, 571, 604
19115561	11083	205	1999482	20620	287	20237057	12602	588	20699808	14921	449, 510
19115586	19199	205	1999482	20620	287	2024778	18938	357	20712172	15463	438
19115640	21476	211	1999482	20620	287	2024781	8300	339	20712176	15463	438
19115673	1712	226, 253	1999482	20620	287	20274997	12824	588	20713843	15684	347
19116359	21475	211	1999482	20620	287	20298365	11677	506, 509	20-72-175	13220	115, 779, 805, 863
19119304	21752	213	1999482	20620	287	20319841	12731	461, 509	2072728	8746	129
19130464	20397	298, 611	1999482	20620	287	20325696	12656	349	20732399	10831	457, 509
19168447	13669	182	1999482	20620	287	20328600	15467	439	20734005	17092	507, 511
19168448	19262	182	1999482	20620	287	20340710	15463	438	2074089	8971	883
19177104	17111	227	1999482	20620	287	20345137	14549	624	2074089	23298	883
19179280	22935	226, 233, 238, 277, 278, 280	1999482	20620	287	20346654	14217	612, 643, 665	20742994	23831	587
19183888	20758	749, 829	1999482	20620	287	20348200	12315	625	20747508	17341	439
19183917	20757	749, 829	1999482	20620	287	20351035	12065	80, 86	2075380	19055	339
191-853-577	21508	850	1999482	20620	287	20353101	23860	434	2084421	8774	192
191-941-142	21498	851	1999482	20620	287	20363491	13999	524, 570, 603	2085119	16940	356
19206781	15499	191	1999482	20620	287	20374473	12737	506, 509	2085119	19057	339
19209790	21828	213	1999482	20620	287	20375100	23939	358	2085823	19060	339
19209791	21829	213	1999482	20620	287	20376243	4441	429	2096466	14892	196
19209792	21830	213	1999482	20620	287	20413107	11612	451, 509	2096467	15504	196
19209793	21831	213	1999482	20620	287	20421672	13752	342	2096900-00-18	22949	771
19209794	21832	213	1999482	20620	287	20421800	12992	507, 509	21006725	18023	314
19209795	21833	213	1999482	20620	287	20423550	15774	42, 48	21021319	18749	355
19209796	21834	213	1999482	20620	287	20423647	13747	341	21030249	17216	557, 559
19209797	21749	213	1999482	20620	287	20426301	14260	532, 570, 599, 766, 841	21030249	17216	557, 559
19209798	21750	213	1999482	20620	287	20429500	14553	624	21035018	14031	583
19209799	21751	213	1999482	20620	287	20432975	13748	341	21039129	17975	466, 511
19209800	21752	213	1999482	20620	287	20433026	13753	342	21039141	17215	465, 511
19257054	16898	288	1999482	20620	287	20451119	13457	539, 570, 599	21042045	17218	488, 511
19257054	B9006	292	1999482	20620	287	20452072	13751	342	21042053	17218	488, 511
19257055	B9004	291	1999482	20620	287	20453400	12064	80, 84			
19257057	20599	288	1999482	20620	287						
19257058	B9007	292	1999482	20620	287						
19257375	17112	226, 253	1999482	20620	287						
19258649	21006	218	1999482	20620	287						
19260056	21487	622	1999482	20620	287						
19260058	21404	621	1999482	20620	287						
19260061	21406	622	1999482	20620	287						
19260086	17172	217	1999482	20620	287						
19260663	21072	621	1999482	20620	287						

O.E.M. INTERCHANGE BY NUMERICAL ORDER

OEM No.	Auveco No.	Page No.	OEM No.	Auveco No.	Page No.	OEM No.	Auveco No.	Page No.	OEM No.	Auveco No.	Page No.
3065575	16261	506, 511	34908-ST3-E01-HE	B7440	290	375480-S100	5195	141	383229-S	11106	339, 348
			3500378J02	BH13	292	375480-S102	5195	141			
30753487	22138	862	3509575	9905	214, 215, 267, 280	375930-S100	2595	141	383255-S36	16770	127
30753556	22137	862				375936-S	17469	348	383356-S	14756	627, 649
3078511	11130	465, 509	351050-S3	2309	443	3762180	4265	429			
			3513686	13542	267	3762180	4280	429	383569	8623	37
30808521	22340	862	351450-S3	2309	443	376337-S100	9853	36	383569	8624	37
309414	16835	560, 572, 601, 656	35178-30010	24304	309	376337-S100	9854	36	383569	8625	37
			35178-50010	24305	309	376337-S100	9855	36	383847-S	11419	173
3104-426	13173	850, 862	352839	4258	429	3764017	23725	625, 626	384051-S	19418	469, 513
			353123	1256	443						
31214496	22556	862	3533539	16940	356	3764863	12599	267	38411S	12949	173
3156A	B3156A	290	3533539	19057	339	3764865	12598	267	38411-S	12949	173
3156NA	18475	287	3536964	24241	314	3767196	18979	434	3843245	12598	267
3157A	B3157A	290	3536966	18665	303	376785-S2	15351	127	3843345	12628	202
3157NA	18001	286	353745-S	2598	167, 435	376988-S2	10654	22	3843386	16349	195
3157SA	18479	287				377537-S	16039	24	3843392	12627	202
3201767	13966	141, 807	3538469	21047	314	3783002	5278	64, 65	3843432	13233	267
			3538874	18394	566, 573, 660	3783006	5228	71	384432-S	19459	353
32195AA001	24235	318				3783794	5195	141	384474-S47X	23799	42, 47
3236813	12927	172	3540161	16940	356	378527-S100	17470	349	3846202	15783	38, 40
3237451	12949	173	3540161	19057	339	37888	12525	129, 130			
3239826	12935	171	354076	11246	581				384930-S36	23666	38
325338	23617	613	3540858	18308	549, 573, 606	37891	12523	129, 130	384931-S36	17035	38, 41
328570-S	23608	451, 521	3541113	16782	555, 572, 713, 799				384932-S36	23665	38
						37892	12521	129, 130	385189-S100	11620	346
3297373	11442	223	3541113	22765	550, 580, 863	379046-S	8427	63, 69	38529-689A-6300	14323	478, 510, 705
33102-TLA-A01	25063	693							385323-S100	11621	347
33103-S3V-A01	B9005	291	354341-S	5196	141	3793876	18979	434	385330-S	11336	473, 509
33103-S3V-A01	B9005	291	354400	12939	173	379830-S	9862	627			
33111-SR3-A01	18661	288	354860-S	4248	429	379830-S	14756	627, 649	385353-S	12210	171, 433
33115-S7A-003	B9005	291	355891	2611	141				385400	15345	127
33115-S84-A01	16897	288	357020	12918	172	379831-S	8814	148	385595-S	19655	465, 513
33115-S84-A01	B9005	291	3574085	11653	649	379831-S	10052	148	385661-S	11351	461, 509
33115-S84-A01	16897	288	357811	4246	429	3799089	14858	661	385677	19425	468, 513
33115-S84-A01	B9005	291	357-827-998	20933	852	380098-S2	8306	339			
33116-TA0-A01	B9006	292	357-853-575	21509	480, 517, 855	380111-S	12949	173	385974-S	19460	356
33116-TA0-A01	B9006	292				380334-S	8310	339	3861577	11347	453, 509
33152-TLA-A01	25063	693	357-853-585-A	21496	481, 855	380370	8418	72			
33165-SAA-003	BH11	292				380382	9829	583	3861577	11347	453, 509
33165-SAA-003	BH11	292	358107	2272	443, 665	380575-S2	8847	38, 41	3861577	11347	453, 509
33165-TL0-003	16694	217, 242, 276	358470	9361	443				3861577	11347	453, 509
			358501	8746	129	380613-S	4439	171, 433	3861577	11347	453, 509
332364	10831	457, 509	358560	19626	864	380614-S	4440	171, 433	386299-S	16954	644
			358560-S100	19626	864				386553-S	19655	465, 513
332364	16259	457, 511	3588314	13541	216, 267	380615-S	12209	171, 433			
						380707-S	11368	72	3866846	15345	127
33301-ST7-J01	B7440A	290	36003452	13454	453, 509	380707-S	11370	64, 69	387042-S	12939	173
33303-S2R-003	B7440A	290				381090	23657	652	387065-S	12932	173
33303-S30-003	19206	287	362069	11638	81, 87	381671-S	10642	42, 46	387074-S	12933	173
33303-SCK-003	B7440A	290				381801-S2	15774	42, 48	387182-S	11671	488, 509
33303-SD4-671	16901	286				381818-S2	9880	146	387258-S	11679	453, 509
33303-SL4-003	19206	287				381863-S2	9879	146	387466-S	12209	171, 433
33303-SZT-A01	22887	287	362379	11245	581	38211-SD2-000	15932	211	387477-S	11797	490, 509
3357NA	18478	287	363137	15461	506, 510	38212-SE0-000	15933	211	387496-S	11672	506, 509
34201287	16826	63, 67, 80, 84	365266	11826	581	382163-S	19826	144	3876130	16240	140
			365270	11718	582	382413-S2	17460	43, 50	387843-S	11705	533, 570, 639
34201358	15331	109	3655015	4233	429				387944-S	11706	548, 570
34201621	12567	539, 570, 602, 657	3664645	4237	429	382461-S9	23713	126	387980-S	12948	173
			3671410	12918	172	382570-S	23608	451, 521	388020-S47	24178	42
34202672	13993	540, 570, 604, 640	367291	14976	38, 39, 139				388034	12919	172
			367292	12995	139	3828472	18329	354	388047-S100	11852	346
34202787	15478	462, 510	3673945	12918	172	382929-S	12729	613	388047-S102	12653	347
			3688699	8963	883	382930-S	14531	297	388047-S1021	11852	346
342271	16253	140	3688811	4235	429	383000-S	12929	171	388047-S1021	12653	347
3426388	2272	443, 665	3689084	4236	430	383000-S	12929	171	388131-S	12925	172
			3691590	10831	509	383001-S	12930	171	388246-S	11612	451, 509
34301-692A-0000	14317	699				383003-S	12937	171	388248-S-36B	11768	144
343541	11243	581	3693099	14217	612, 643, 665	383004-S	12935	171	388442-S100	12652	359
343543	11246	581				383005-S	12931	171	388442-S309	12652	359
343555	11243	581				383016	12916	172	388499-S	23683	490, 521
343555	11245	581				383031	12927	172			
343555	11246	581				383033-S100	11863	443	388577-S	11146	457, 509
34355-SD2-003	15997	692	3693292	4250	430	383033-S101	11863	443			
3441734	12930	171	370247-S2N	5586	146	383132-S9	23713	126	388664-S100	14127	355
3441743	12930	171	370374-S	4248	429	383142-S	20310	535, 575, 639	388904-S	20316	461, 514
3454220	15673	620, 662	3711168	4265	429				388908-S	14163	465, 510
			3722635	2619	865	383207-S	14217	612, 643, 665	388908-S	19655	465, 513
3454221	15674	620, 662	3722635	12958	865	383229-S	11104	339, 348	388916-S	12908	171, 433
			3725377	23755	626				388930-S	12909	463, 509
345510	11154	215	372741-S100	9864	296						
3457A	B3457A	290	372820-S36	12654	358						
3457NA	20588	287	372820-S40	12654	358						
347065	16237	140	373528-S32	5854	141						
347347	13450	583	373846-S	12918	172						
347893	11292	144	3744750	12237	215, 241						
34901-SZ3-000	BH1	292									
34901-SZ3-000	BH1	292	3744999	2752	865						
34901-TK8-A01	B921	290	3744999	12960	865						
34906-S30-003	19207	287	3745361	4280	429						
34906-SL0-A01	20296	287	3751212	12923	171						
34906-ST5-003	19207	287	375203-S	17467	349						
34908-SA0-811	BH3	292	375372-S	5592	474, 509						
34908-SA0-811	BH3	292					</				

O.E.M. INTERCHANGE BY NUMERICAL ORDER

OEM No.	Auveco No.	Page No.	OEM No.	Auveco No.	Page No.	OEM No.	Auveco No.	Page No.	OEM No.	Auveco No.	Page No.
45334	15345	127	480534	10832	457,	5080631AB	24261	319	51-44-7-780-135	21499	682,
4533699	8583	436			509	5097712AB	24286	330			772
454626	16919	286	4805405-AA	19638	568,	5103921-AA	20637	551,	51453-0E010	21860	561,
454646	18004	286		573, 640,	661			575, 776		578, 757,	845
455136	16920	286	4805405-AB	19638	568,	51-11-1-908-077	20234	533,	51453-48010	21860	561,
455490	16918	286		573, 640,	661			575, 685, 775		578, 757,	845
4563173	4240	430	4806226-AA	21187	613	51-11-1-944-537	20734	556,	51454-0E010	21856	553,
4564974	4264	429	4806240-AA	20768	547,			575, 687		578, 756,	844
4565415	4240	430			576, 658	51-11-1-964-186	22401	534,	51454-48010	21856	553,
4580779	14011	537,	4806240-AB	20768	547,			579, 686		578, 756,	844
		570, 602			576, 658	51-11-7-071-270	25318	689	51-46-7-002-606	21779	525,
45998051	12119	110,	4806271-AA	22028	651	51-11-8-174-185	20248	557,		578, 685	
		667	4806334-AA	20963	567,			575, 687	51-46-7-453-747	22819	480
46064AE000	21593	530,		576, 660	576, 660	51-12-7-004-445	21778	558,	51-47-0-146-782	20638	555,
		578, 813	4814094	25223	665			578, 687		575, 686,	777
4619387	23726	625	4853108	8398	865	51-12-7-046-911	22788	688	51-47-0-390-017	20638	555,
4628769	19626	864	4856641	24285	330	51-12-7-046-911	22788	688		575, 686,	777
4630088	18031	341	4856651	24285	330	51-12-7-070-202	22113	116,	51-47-1-840-961	25320	678
4630088	18028	341	4856880	10733	128			149, 150, 690, 861	51-47-1-911-992	20638	555,
4630660	18028	341	4857108	17103	534,	51-12-7-070-202	22841	116,		575, 686,	777
4630660	18031	341		572, 603,	640			150	51-47-1-919-209	22052	557,
4636358	23144	268	4857182AA	25219	456,	51-12-7-461-407	22858	681,		578, 687	
4636360	18921	268			523			780	51-47-7-117-532	22090	504,
4637277	20175	864	4857327AA	23107	268	51-12-7-488-348	25399	680		519, 684	
4638136	14753	540,	4857345-AA	20457	560,	51-12-7-488-355	25419	680	51-47-8-166-992	21780	524,
	571, 601,	638, 656			575, 659	51-12-7-488-356	25400	680		578, 685	
4638136	14993	540,	4857699-AA	20771	655	5113015-AA	18032	526,	51-47-8-234-047	25321	678
		571, 776	4857753-AA	20359	547,			572, 655	51-47-8-244-458	22861	678
4638136	23826	539,			575, 605	51-13-1-804-205	13158	678	51-48-1-884-779	22710	549,
		580, 600	4860198	10330	583	51-13-1-829-904	21767	679		580, 775	
463-988-02-78	20735	505,	4860375-AB	20667	650	51-13-1-885-399	25319	568,	51-48-1-915-964	20270	550,
		515, 773	4860379-AA	21026	458,			580, 685		575, 687	
4657731	2628	437			516	51-13-1-934-160	22202	680	51-48-1-915-964	22893	552,
4658444	19191	662	4872948	4446	429	51-13-1-946-258	25401	679		580, 686	
4658673	19149	451,	4876498	10744	468,	51-13-1-960-054	21429	679	51-48-1-938-725	20270	550,
		513			509	5113360-AA	20529	586		575, 687	
4658677	14967	619,	4877001	8386	865	51-13-6-440-146	21767	679	51-48-7-273-379	22782	476,
		647, 662, 665	4878883-AA	17004	466,	51-13-7-034-022	25402	780		682	
4658887	20165	449,			511	51-13-7-065-607	22789	480,	51-48-8-126-849	22524	681
		514	4878883-AA	20164	466,			683	51-48-8-126-849	22524	681
46-63-7-659-479	25204	94			514	51-13-711-7-240	22791	679	51-48-8-181-420	21757	476,
4676189	19807	865	4882723	11120	450,	51-13-7-269-358	22792	684		682	
4676356	19339	664			509	51-13-7-269-367	22785	678	51-48-8-252-749	22895	680
4676589	23223	268	4887979	23563	613	51-13-7-291-271	25403	679	51-48-9-119-216	22782	476,
4689929	2744	864	4887980	23563	613	51-13-8-166-675	21432	679		682	
4696129	18033	472,	4897087AA	23198	271,	51-14-1-807-495	22892	681	51-49-0-151-605	22057	481,
		511			273	51-14-8-209-932	22790	682		519, 683	
4696488	14995	528,	490067	11770	37	51-14-8-209-932	22790	682	51-49-7-054-228	22862	481,
		571, 600,	490067	11771	37	51-16-1-881-149	20187	525,		522, 683	
		637, 655	4963	15015	130			573, 775, 857	51-49-8-105-790	22057	481,
4699315	2619	865	4A0-805-121C	22208	855	51-16-1-943-122	22783	688		519, 683	
470434	20796	432	4A0-805-163	21815	852	5116530-AA	20966	545,	51-49-8-123-832	22057	481,
471064	23795	42,	4A0-853-825-A	21493	849			576, 658		519, 683	
		50	4A0-867-276	21818	861	5116530-AA	20990	548,	51-49-8-166-702	22201	528,
4717164	18393	619	4A0-867-276-A	22108	850			576, 606, 659		579, 685	
4717165	18392	619	4D0-807-300	22101	561,	5116530-AA	21680	541,	51-49-8-237-075	22855	535,
4717224	19855	457,		578, 859	578, 859			656		686, 781	
		514	4D0-867-299D	22204	857	51-16-8-197-908	22303	527,	5159077-AA	20964	651
4721222	4281	430	4F0-805-163	22098	861			579, 685, 781	5159077-AB	20964	651
4723818	2789	864	4F0-825-429A	22235	853	51-16-8-197-908	22303	527,	5160260-AA	20966	545,
4723818	12961	864	4F0-831-719	22716	484,			579, 685, 781		576, 658	
472434	11699	539,		521, 855	521, 855	51-18-1-821-830	18156	64,	516637	8744	129
		570, 602, 656	4F1Z-9A317-AA	21214	644			65	51-71-1-928-946	23902	580, 685
472450	15453	431	4F9Z-13411-A	25296	247	51-21-8-205-295	20388	556,		516, 780	
472812	12935	171	4H0-825-429-A	25036	849			575, 687	51-71-1-958-025	20645	778
472814	12921	172	4L0-886-373	22094	852	513388	4243	429	51-71-1-958-025	22087	688
472815	12922	172	4L3Z-1510182-AA	20862	632	51-41-0-407-983	22229	500,	51-71-1-959-929	25404	680
4728204	23123	274	4M0-805-163	25263	486,			520, 684	51-71-7-002-953	20754	341
4730773	20175	864			523, 856	51-41-0-407-984	21788	500,	51-71-7-006-757	22140	679
474821	14976	38,	4U2Z-14S411-DA	20852	251			518, 684, 781	51-71-7-048-316	25322	682
		39, 139	4U2Z-14S411-RA	23055	243,	51-41-0-407-984	21788	500,	51-71-7-066-220	22141	680
4753738	24343	302			258			518, 684, 781	51-71-7-066-223	22142	680
4755299	8435	71	5012874-AA	19628	502,	51-41-1-870-718	22585	505,	51-71-7-066-226	22092	508,
4759145	2943	864,			513			521, 683		519, 683	
		598	5013984AA	23073	268,	51-41-1-973-500	20253	506,	51-71-7-066-299	22091	508,
4761842	2943	864,			272			514, 684, 775		519, 682	
		598	5014002-AA	23269	249,	51-41-7-067-920	25203	44,	51-71-7-154-239	25405	681
4762490	23895	649		255, 260, 270, 272, 273	272, 273			57, 92, 102	51-71-7-154-520	22784	688
476737	23887	883	5014003-AA	23271	260,	51-41-7-325-082	22853	493,	51-71-8-108-613	23952	678
4767559	4446	429			273			683	51-71-8-195-811	25420	568,
4770719	24147	613	5017124AB	23072	271	51-41-8-172-050	13179	505,		580, 686	
47749-06010	21357	749	5017410-AA	14021	450,			509, 683, 856	51-71-8-218-852	25252	688
47749-06010	21357	749			510	51-41-8-224-768	21788	500,	51-71-8-234-698	25093	497,
47749-06010	21357	749	5019910-AA	23181	222,			518, 684, 781		522, 684	
47749-08010	20757	749,		235, 240, 248, 259,	266	51-41-8-224-768	21788	500,		679	
		829	5023111-AA	19804	505,			518, 684, 781	51-71-8-259-025	22559	679
47749-50090	21357	749			514	51-41-8-224-781	22229	500,	51-75-7-271-848	22084	681
47749-50090	21357	749	5023173-AA	20563	504,			520, 684	51-77-7-171-002	21787	486,
47749-58010	20757	749,			515	51-43-0-141-025	22229	500,		518, 683, 781	
		829	5023351-AA	19804	505,			520, 684	51-77-7-171-002	21787	486,
4778578	24257	320			514	51-43-7-001-491	21873	500,		518, 683, 781	
4778814	2744	864	5028438-AA	20428	503,			519, 684, 808	51-77-7-171-004	22147	691
4779348	2943	864,			515	51-43-7-001-491	2138	498,	51-77-7-891-250	22597	679
		598	5073327-AA	20187	525,			516, 781			
4784018-AA	21231	650		573, 775, 857	857	51-43-7-194-187	22109	689			
4801268	3620	473,	5080631AA	24261	319						
		509									

O.E.M. INTERCHANGE BY NUMERICAL ORDER

OEM No.	Auveco No.	Page No.	OEM No.	Auveco No.	Page No.	OEM No.	Auveco No.	Page No.	OEM No.	Auveco No.	Page No.
51787-60070	22479	745	53879-14010	14750	113,	55914-S2	13021	45,	5GC71RK5-AA	20273	575,
5183448AA	23135	222,		114, 147, 769, 848,	113,			59		639,	656
		269	53879-14010	19669	113,	559312	11655	582	5GF92RC3-AA	20273	575,
5183468-AA	19472	610,			114, 147	559312	11871	582		639,	656
		643	53879-14010A	14750	113,	560625	12937	171	5GF92RK5-AA	20273	575,
5189180-AA	21154	653		114, 147, 769, 848,	113,	560692	11419	173		639,	656
5208743	15040	455,	53879-14020	14750	113,	56115-30100	25345	746,	5GUU9K111BA	20993	564,
		510		114, 147, 769, 848,	113,			824		576,	608, 642
52115-0C090	21221	822	53879-14020	19669	113,	56115-30100	25345	746,	5J0-853-573	25314	853
52115-48040	21132	822			114, 147			824	5K0-837-975A	22759	580,
52161-02020	18873	547,	53879-17020	21359	113,	562327	11831	613		858	
		573, 843			759, 848	5655006	9905	214,	5L8Z-16828-AA	16954	644
52161-02030	18873	547,	53879-17020	21359	113,			215, 267, 280	5N2Z-13466-A	B7440A	290
		573, 843			759, 848	568792	19626	864	5R3Z-54310D12-AA	A21024	541,
52161-16010	18873	547,	53879-22010	14276	115,	568792	19627	864		576, 641,	766
		573, 843			849	56910-S2	13025	42,	5R3Z-54310D12-BAA	A21560	454,
52161-20010	20931	547,	53879-22030	14750	113,			48		518,	763
		576, 843		114, 147, 769, 848,	113,	56910-S424	13025	42,	5T2Z-13411-A	25292	247
52188-06030	22197	828	53879-28010	22412	829			48	5U2Z-14S411-DA	23024	254
52197-22020	22096	748,	53879-30040	21797	749,	56911-S2	13711	42,	5U2Z-14S411-DB	23024	254
		828			829			49	5U2Z-14S411-SA	19156	250,
52197-22020	22096	748,	53879-30040	21797	749,	56911-S36	13711	42,	5U2Z-14S411-SB	19156	250,
		828			829			49		251	
52197-30040	21682	748	53879-30050	22489	749,	56911-S61	13711	42,	5U2Z-14S411-TA	19156	250,
52197-30040	21682	748			829			49		251	
52-20-1-964-201	22521	457,	53879-30050	22489	749,	56912-S	13026	42,	5U2Z-14S411-VA	19582	251
		521			829			43, 50	5U2Z-14S411-ZB	20842	248
52-20-8-133-466	22794	449	53879-33030	22944	749,	56929-S2	13711	42,	5U2Z-14S411-ZB	23199	249
52535-0E010	21015	748,			829			49	5Z0-853-695	22849	852
		826	53879-33030	22944	749,	57030-S2	10823	38,	6000020	2611	141
52535-0E030	21712	746,			829			39	60000305	24144	435
		821	53879-50020	21358	749	57030-S36	17034	38,	6000121	13173	850,
52535-50060	21015	748,	53879-50020	21358	749			39			862
		826	53879-58010	20758	749,	57032-S36	24168	38	6000558	10073	141
5255110	18979	434			829	57039-S2	9756	38,	6000605	5854	141
52599-0E010	21084	748	53879-58010	20758	749,			40	6000705	2619	865
52599-48020	22335	753			829	57039-S2	23662	38	6000705	12958	865
528846	13004	140	53879-60010	20335	540,	57041-S2	23663	38	6000709	2744	864
5297428	18952	186			575, 842	57041-S36	23665	38	6000720	2752	865
53041045	16873	873,	53888-48010	21225	543,	57048-S2	23664	38	6000720	12960	865
		874			577, 843	5706	15018	131	6000943	9377	649,
53145-12010	22163	818	53935-35020	21162	823	5716	15015	130		807	
53145-60030	22212	475,	54229-0201P	16340	436,	57160FC000	21568	549,	6001419	5592	474,
		520, 751, 831			803			577, 815		509	
53145-60030	22212	475,	547944	4439	171,	57160FC010	22042	809	6002893	10622	437
		520, 751, 831			433	57371GA070	22210	815	6003147	11354	652
53259-0E010	21525	547,	5480766	19505	827	574355	19626	864	6003201	23637	652
		577, 756	5480772	20863	561,	574355	19627	864	6003220	8853	469,
53271-0B010	22102	748,			576, 607	57472-S2	24177	38		509	
		817	5480852	20756	593	575411	2789	864	6003308	20276	437
53271-0B010	22102	748	5480853	8889	338	575411	12961	864	6003349	11678	506,
		817	5482087	21284	613	57728AC090	19246	544,		509	
53271-12040	22102	748,	5482103	20881	482,			573, 799	6003351	11136	473,
		817			516	57750AA090	21578	577, 815		509	
53271-12040	22102	748,	5485676	17216	557,			42,	6003409	20276	437
		817			572, 606, 641, 659	588546	15037	47	6003423	11673	461,
53271-12060	22102	748,	549790	11640	81,			553,		509	
		817			88	59114AG000	21192	800	6003486	23721	652
53271-12060	22102	748,	55022134	15042	571			552,	6003587	11675	453,
		817	55055098	18248	473,	59122AC030	21580	577, 814		509	
53271-44010	20738	747,			511			551,	6003737	12563	587
		817	55074801	14010	564,	59122FA010	21571	577, 814	6003752	20276	437
53326-08010	21211	466,			570, 602, 657			529,	6003774	13927	652
		516, 833	55075139	17214	526,	59130AA000	14697	570, 599, 713, 765	6003817	23730	652
53384-0R010	22126	548,			572, 599			862	6003878	20276	437
		579, 843	55116997-AA	22461	504,	591-740	12637	582	6003916	20276	437
53384-68010	22126	548,			521	5949838	3178	582	6003965	13927	652
		579, 843	55116997-AB	22461	504,	5953005	5788	582	6004036	17151	437,
534343	11831	613			521	5963268	11156	215		652	
53455-14020	14732	846	55156429-AA	20523	653	5973400	12757	565,	6004212	14005	341
53455-33010	19529	846	55156447-AB	20700	654			570, 602	6006264	3404	128
53455-33011	19529	846	55156655-AA	21738	655	5973400	19847	562,	6010029	19626	864
53857-0E010	22334	753	55156879-AB	20962	651			573, 602	6010029	19627	864
53857-12010	22346	744,	55157055-AA	20700	654	5973823	19847	562,	6010046	2752	865
		818	55157055-AA	20887	654			573, 602	6010046	12960	865
53857-12010	22346	744,	55157065-AA	20887	654	5973996	12756	570, 603	6010093	2744	864
		818	55157069-AB	20827	654			130	6010093	12959	864
53857-47011	22103	466,	55157070-AC	20828	653	5988-L	15010	130	6013029	2619	865
		520, 752, 832	55157112-AA	20890	569,	5988-L	15010	130	6013029	12958	865
53857-47011	22103	466,			576, 661	5BBI4LX9	19245	549,	6013122	11677	506,
		520, 752, 832	55157112-AB	20890	569,			573, 659		509	
53867-47020	21237	828			576, 661	5C3Z-12224-A	18527	232,	601-997-02-30	18026	318
53879-02070	20758	749,	55176248	14020	565,			256	6023204	15345	127
		829			570, 608	5C3Z-12224-A	23034	234,	6025004	15345	127
53879-02150	22944	749,	55177482AA	25253	662			257	6025005	15347	127
		829	55256967-AC	19816	434	5C3Z-13466-AA	18016	286	6025007	15350	127
53879-02150	22944	749,	55275388-AB	23944	434	5C3Z-13466-AA	18465	286	6025329	9480	38,
		829	55350747-AB	19775	504,	5C3Z-13N021-AA	BH13	292		39	
53879-02150	22944	749,			514	5C3Z-14S411-AA	23064	244,	6026166	16237	140
		829	554343	11831	613			254, 259, 264	6026430	9299	126
53879-06100	21797	749,	55568037	21650	316	5F7Z-13466-B	20285	287	6026723	10655	37
		829	55577568	22360	314	5FR56DX9	19894	653	6026723	10656	37
53879-06100	21797	749,	556992	12932	173	5FR56XXX-AB	19894	653	6026723	10657	37
		829	557057	11655	582	5GC71RC3-AA	20273	575,	6026958	10086	126
53879-0R010	22412	829	557057	11871	582			639, 656			
			557057	12605	582						

O.E.M. INTERCHANGE BY NUMERICAL ORDER

OEM No.	Auveco No.	Page No.	OEM No.	Auveco No.	Page No.	OEM No.	Auveco No.	Page No.	OEM No.	Auveco No.	Page No.
6027958	19485	72	6100811	12253	107	63844-01A00	16858	557	6502089	16876	873
		649, 782	6100815	16829	107		572, 639, 739, 767, 800				874
6029348	16852	126	6100839	12122	110	63844-01A99	14726	538	6502090	16877	873
6029501	12735	583	6100840	12123	110			571, 799			874
		649, 851	6101283	11629	117	63844-D0100	14727	569	6502091	16878	873
6030441	11146	457			152			571, 733, 801			874
		509	6101308	18449	116	63846-5V000	21768	729	6502104	18771	462
6030441	15414	457			151			791			512
		510	6101455	12160	80	63846-9E000	20813	793	6502152	16846	116
6030441	18815	452			85	63848-01G00	16782	555			150
		512	6101718	19455	86			572, 713, 799	6502328	14921	449
6030538	10832	457	6102396-AA	19455	86	63848-35F00	19735	113			510
		509	6104374-AA	22906	81			804	6502381	18815	452
6031091	11621	347			87	63848-40Y00	20613	545			512
6031115	11620	346	6104900-AA	21086	551			575, 799	6502407	16826	63
6031147	8865	127			576, 659, 776	63848-5HA0A	19735	113			67, 80, 84
6031321	10831	457	6104908-AA	18302	450			804	6502450	16876	873
		509			512, 672, 703	63848-9E001	20327	546			874
6031383	11704	539	6105103-AA	22908	81			575, 799	6502491	16870	873
		570			88	63848-9Y000	21664	732			874
6031390	11699	539	6105242-AA	22539	116			804	6502573	18032	526
		570, 602, 656			150	63848-AQ100	22764	499			572, 655
6031438	12995	139	61118-35010	21194	818			522, 797	6502625	16835	560
6031869	12713	585	61-13-8-350-827	22854	687	63848-D0100	17193	114			572, 601, 656
		650, 807	612019	9298	126			804	6502632	16816	529
6032061	12566	585	61991-35010	21234	822	63848-D4000	17385	114			572, 603, 656
		650	61992-35010	21235	822			804	6502689	18501	341
6032083	16851	126	62217-13010	20558	492	63848-D4001	17385	114	6502738	17353	129
6032138	16687	351			515, 753, 836			804	6502745	16868	873
6032363	11351	461	62217-33031	22158	822	63854-01A00	17472	557			874
		509	62217-42030	25413	824			572, 785, 801	6502790	14753	540
6032516	13466	71	62228-51S00	19147	804	63876-95596	16000	550			571, 601, 638, 656
		649	622A2-9E000	21361	564			571, 714, 767, 800	6502842	17975	466
6032856	17615	349			577, 609, 801	63878-01E10	20348	559			511
6032856	23861	350	622A2-9E000A	21361	564			575, 800	6502871	14992	534
6032881	12652	359			577, 609, 801	639-998-01-85	20647	772			571, 637, 655
6032926	12655	347	62318-01W00	16860	786	639-998-01-85	23228	681	6502907	17669	501
6032926	14486	347	62318-H8500	21121	786			772			511
6033018	23884	458	62319-0W000	20266	789	645350	1256	443	6502988	19519	614
		522	62319-AU000	22287	729	6466355	12920	172			663, 666
6033082	17664	457			793	6500092	12617	129	6502991	17685	504
		511	62380-U7400	17196	792	6500284	15329	109			511
6033184	2625	71	62489-0E010	22460	754	6500361	14561	664	6503106	18269	562
6033560	15345	127			840	6500524	12569	627			573, 660
6033677	14756	627	62489-0E010	22460	754			649	6503163	14997	534
		649			840	6500526	12715	129			571, 600
6033688	18810	357	62581-14020	16778	505	6500650	15860	874	6503204	18862	502
6033840	17664	457			511, 765, 835	6500651	15861	874			512
		511	62660-48600-1	20381	476	6500653	15861	874	6503221	12766	461
6033854	23850	45			515, 703, 783, 795	6500722	15862	874			509
6033862	11349	505	62698-V7000	14313	700	6500724	12569	627	6503339	18249	661
		509			761, 789			649	6503401	19417	62
6034212	18461	351	6270163	19418	469	6500787	14016	524			93, 105, 610, 661
6034213	10375	127			513			570, 603, 657	6503433	18375	317
6034213	24080	127	6271904	20803	432	6500898	13755	341	6503453	18394	566
6034336	19310	663	6271989	14559	623	6500899	13748	341			573, 660
6034376	18373	311	6272766	12918	172	6500911	13750	342	6503454	18327	539
6034608	23933	452	62731FA000	21629	810	6501025	12125	110			573
		522	62731FA010	21587	810	6501067	15481	460	6503573	15861	874
6034703	18934	45	6276604	3617	447			510	6503598	17216	557
		60	6280765	3617	447	6501086	20316	461			572, 606, 641, 659
6034812	19310	663	62828-AG000	22762	566			514	6503709	19213	487
6034848	19657	349			580, 801	6501178	14980	110			513
6035094	2562	126	62869-N4700	14723	478	65011868	13747	341	6503741	11691	583
6035188	18934	45			510, 795	6501301	16818	455	6503768	18301	455
		60	6288704	8777	190			511			512
6035201	17639	359	6294493	13548	223	6501415	16980	110	6503800	13748	341
6035201	19263	359	6294737	15935	191	6501509	18242	341	6503812	19779	664
6035274	14037	585	62955-12010	15695	818	6501544	14021	450	6503819	19417	62
		650	62955-20020	15695	818			510			93, 105, 610, 661
6035296	14009	585	62955-50010	22456	745	6501559	13751	342	6503860	17101	342
6035401	20179	650			819			660	6503892	18827	465
6035414	19406	349	62955-50010	22456	745	6501773	12569	627			512
6035417	18373	311			819			649	6503896	17669	501
6035807	19310	663	6298886	9883	215	6501773	23885	650			511
6036148-AA	18461	351			241, 280	6501825	12259	110	6503938	18913	341
6036148-AA	20629	352	6298886	11166	241	6501916	15543	458	6503943	20189	459
6036155-AA	11146	457			280			510			514
		509	6298886	13558	216	6501925	18030	539	6504014	17669	501
6036155-AA	15414	457	6298892	9883	215			572, 658			511
		510			241, 280	6501948	19893	454	6504014	18915	501
6100042	11629	117	6298892	13558	216			514			512
		152	6298935	9883	215	6502078	11146	457	6504018	19141	317
6100047	19216	109			241, 280			509	6504043	17612	458
6100048	15329	109	6299087	11157	215	6502078	15414	457			511
6100049	15331	109			267			510	6504072	19793	650
6100050	15333	109	63-17-1-637-868	20647	772	6502081	16871	873	6504090	12567	539
6100053	15337	109	63-17-1-637-868	23228	681			874			570, 602, 657
6100539	12232	80			772	6502083	16872	873	6504098	19338	464
		83	63-21-7-160-777	BH1	292			874			513
6100566	12160	80	63-21-7-160-779	BH3	292	6502085	16873	873	6504135	19541	513
		85	63-21-7-160-781	BH7	292			874	6504424	18375	317
6100567	19455	86	63-21-7-160-784	BH11	292	6502087	16874	873	6504452	17669	501
6100568	15818	81	63-21-7-160-785	B9005	291			874			511
		87	63-21-7-160-786	B9006	292	6502089	16875	873	6504521	19422	547
6100810	12115	107	63-21-7-190-591	BH13	292			874			573, 658

O.E.M. INTERCHANGE BY NUMERICAL ORDER

OEM No.	Auveco No.	Page No.	OEM No.	Auveco No.	Page No.	OEM No.	Auveco No.	Page No.	OEM No.	Auveco No.	Page No.
6504555	17222	534, 572, 603, 640	6509761-AA	22459	554, 579	67771-12010	14269	498, 510, 733, 764, 838	68033794AA	21442	661
6504601	19779	664	6509799-AA	22578	116, 150	67771-12030	15709	498, 511, 838	68033794-AA	21442	661
6504700	13750	342	6509884-AA	20989	546, 576, 605, 641	67771-12040	19016	500, 512, 839	68034329-AA	21442	661
6504737	23992	342	6509960-AA	21680	541, 656	67771-12050	15709	498, 511, 838	68039280-AA	21528	654
6505223AA	23982	663	6510123-AA	22535	544, 579	67771-12050	19257	499, 513, 754, 838	68053681AA	25324	554, 580, 659
6505292-AA	19386	500, 513	6510139-AA	22354	545, 579, 658	67771-12050	19898	499, 514, 838	68060366AA	23222	268
6505411-AA	10831	457, 509	6510185-AA	22579	116, 151	67771-12070	20473	484, 515, 753, 836	68061648-AA	21329	497, 517
6505417-AA	19836	451, 514	6510197AA	25265	663	67771-12080	20575	496, 515, 753, 837	68063066AA	23222	268
6505425	10831	457, 509	6510359AA	25156	490, 522	67771-12080	15707	499, 511, 839	68073375AA	25184	662
6505534-AA	20829	487, 515	6510520AA	20741	355	67771-16080	19108	499, 512, 839	68073566AA	25188	116
6505539-AA	18862	502, 512	6510521AA	12118	110	67771-16120	18874	500, 512, 839	68084593-AA	21213	651
6505539-AA	19628	502, 513	6510734-AA	22363	560, 579	67771-16160	18874	500, 512, 839	68085677AA	25194	499, 523
6505667-AA	20360	459, 515	6510747AA	25155	490, 522	67771-16170	18875	484, 512, 836	68087885AA	22885	504, 521
6505686-AA	20362	461, 515	6510766-AA	22177	536, 579	67771-16240	22486	754, 839	68122817AA	24262	319
6505759-AA	20427	503, 515	6511238AA	25275	614, 663	67771-16240	22486	754, 839	68139270AA	25279	614, 646
6505813-AA	18934	45, 60	6512734AA	22856	554, 580, 659	67771-22010	14270	499, 510, 838	68143484AC	25220	665
6505878-AA	17124	487, 511	6512752-AA	21679	455, 518	67771-22020	14728	497, 510, 837	68146440AA	22929	653
6505918-AA	20515	500, 515	65487-60010	22497	750, 834	67771-22020	14728	497, 510, 837	68172491-AA	21374	593, 654
6506005-AA	23966	462, 522	65487-60010	22497	750, 834	67771-26240	22486	754, 839	68185909AA	21601	536, 578, 660
6506007-AA	13751	342	65624-V0100	14337	802	67771-26240	22486	754, 839	68210509AA	24261	319
6506008-AA	19639	538, 573, 604, 640	65625-8J000	22573	802	67771-30070	19109	494, 512, 836	68213168-AA	21791	652
6506104-AA	20173	664	65722-01E00	22358	732, 802	67771-30090	19129	502, 513, 839	6822.LL	21822	498, 519, 806, 838
6506132-AA	20458	557, 575, 659	65722-50A00	22362	802	67771-30090	23559	503, 522, 839	6822.LL	21822	498, 519, 806, 838
6506161-AA	19278	43, 52, 91, 97	65722-EA000	21309	802	67771-32090	18844	497, 512, 837	68225214-AA	21835	652
6506214-AA	19141	317	65810-K2000	21229	471, 516, 730, 794	67771-32090	18844	497, 512, 837	68241251-AA	22910	492, 522
6506306-AA	20623	661	65810-K2002	22060	470, 519, 730, 794	67771-32090	18844	497, 512, 837	68250997AC	25325	616
6506654-AA	20274	488, 514	65810-K2009	19724	473, 514, 798	67771-32090	18844	497, 512, 837	68257098-AA	21374	593, 654
6506655-AA	20275	650	65829-50A00	22903	430, 802	67773-0E020	21795	487, 518, 753, 836	68294220AC	25266	620
6506852-AA	20468	650	65832-F5000	17237	466, 511, 796	67773-0E020	21795	487, 518, 753, 836	68353367AA	25439	80, 83
6506852-AB	20468	650	65846-30F00	17237	466, 511, 796	67867-0C010	20443	471, 515, 834	68365015-AA	17222	534, 572, 603, 640
6506955-AA	22909	663	65846-40F00	19468	464, 513, 730	67867-0D060	21707	471, 518, 671, 709, 834	68395634AA	22836	655
6507009AA	25217	628, 651	65846-4Z000	21288	464, 517, 796	67867-0D060	21707	471, 518, 671, 709, 834	68425-H5000	14313	700, 761, 789
6507055-AA	20765	502, 515, 666	661179000	22044	810, 474, 510, 703	67867-0D060	21707	471, 518, 671, 709, 834	68463254AA	25218	567, 580
6507669-AA	20766	556, 576, 659	66421-634-000	14291	474, 510, 703	67867-12150	19749	471, 514, 834	68499019AA	25351	480, 523
6507670-AA	19111	356	66435-648-000	14291	474, 510, 703	67867-12150	19749	471, 514, 834	68499020AA	25349	653
6507686-AA	20765	502, 515, 666	66435-648-000	14291	474, 510, 703	67867-28030	18692	471, 512, 763, 834	68526185AA	22836	655
6507741-AA	21354	318	66820-3S500	20672	483, 515, 796	67867-50020	21694	469, 518, 752	69293-12030	20469	757, 846
6508072-AA	21236	649	66820-3S500-C1	20672	483, 515, 796	67867-50020	21694	469, 518, 752	69293-12040	20470	758, 846
6508197-AA	21098	544, 576, 638	66820-3S510	20614	787	67867-52010	21707	471, 518, 671, 709, 834	69293-12050	20534	758, 846
6508365-AA	20623	661	66820-4BA5A	22476	788	67867-52010	21707	471, 518, 671, 709, 834	69293-12060	20535	758, 846
6508444-AA	21446	341	66820-6IU00	21689	730, 793	67867-52010	21707	471, 518, 671, 709, 834	69293-12060	20535	758, 846
6508506AA	22863	663	66820-9N00A	22128	793	67867-52010	21707	471, 518, 671, 709, 834	69293-30030	21336	758, 846
6508540-AA	21418	348	66820-AX020	21159	798	67867-52010	21707	471, 518, 671, 709, 834	69293-33010	20469	757, 846
6508643-AA	21348	567, 577, 660	66824-01G00	16783	527, 572, 798	67867-89103	18692	471, 512, 763, 834	69293-33020	20470	758, 846
6508712-AA	20888	546, 576, 605, 658	66820-01W01	16859	530, 572, 600, 798	67868-02020	19749	471, 514, 834	693005370	21584	491, 518, 813
6508727-AA	21257	459, 517	67771-01010	14144	499, 510, 838	67868-02020	19749	471, 514, 834	6995.A3	21871	481, 519, 805, 808
6508746-AA	14010	564, 570, 602, 657	67771-02030	15709	498, 511, 838	67868-89101	18692	471, 512, 763, 834	69951-12180	18113	439
6508863-AA	20988	544, 576, 605, 658	67771-02030	15709	498, 511, 838	67869-12050	21551	479, 518, 834	6E0-837-732	22717	854
6508947-AA	21153	654	67771-02030	15709	498, 511, 838	67869-20030	21548	449, 518, 752, 834	6E5Z-13466-AC	B4157K	290
6509049-AA	20880	545, 576, 605	67771-02030	15709	498, 511, 838	67869-20030	21548	449, 518, 752, 834	6E5Z-7850980-AAA	21024	541, 576, 641, 766
6509103-AA	19801	534, 573, 640	67771-02030	15709	498, 511, 838	67869-22010	22357	834	6GIZ-5410182-A	20977	636
6509106-AA	21019	664	67771-02030	15709	498, 511, 838	67869-22010	22357	834	6GIZ-5410182-C	20979	633
6509135-AA	22543	526, 579	67771-02030	15709	498, 511, 838	67869-22030	21548	449, 518, 752, 834	6KO-868-243-C	21398	507, 517, 856
6509288-AA	21223	654	67771-02030	15709	498, 511, 838	67869-22030	21548	449, 518, 752, 834	6NO-809-966A	21816	852
6509432-AA	22289	616, 644, 663	67771-03030	15707	499, 511, 839	67921-32010	19719	482, 514, 835	6NO-867-276	22216	853
6509539-AA	21865	44, 56, 92, 100	67771-04040	19210	501, 513, 839	68003844-AA	20889	558, 576, 607, 641	6Q0-807-643	22399	854
6509590-AA	21679	455, 518	67771-06010	18844	497, 512, 837	68003844-AA	20889	558, 576, 607, 641	6Q0-853-147	22447	860
6509599-AA	22578	116, 150	67771-06030	19109	494, 512, 836	68004187-AA	21187	613	6Q0-867-333	22718	451, 521, 854
6509673-AA	21601	536, 578, 660				68009867-AA	21105	479, 516, 773	6Q0-868-243	21251	563, 577, 859
						68028049-AA	20377	592	6U2Z-14S411-AA	23061	244
						68033045-AA	22209	479, 520	6U2Z-14S411-AB	23061	244
									6U2Z-14S411-CA	23058	243
									6U2Z-14S411-TA	23076	264
									6W1Z-5422008-A	18890	647

O.E.M. INTERCHANGE BY NUMERICAL ORDER

OEM No.	Auveco No.	Page No.	OEM No.	Auveco No.	Page No.	OEM No.	Auveco No.	Page No.	OEM No.	Auveco No.	Page No.
701-867-299	21479	547, 577, 859	75521-611-000	14274	700, 761, 789, 824	76882-0M000	21017	112, 732, 804	80850-89916	22769	467, 731, 794
703-867-299	21450	482, 517, 855	75522-611-000	14255	699, 761, 782, 824	76882-0M060	21619	786	80850-CA003	21588	477, 518, 794
71144-SR3-A00	18415	701	75545-0E020	25429	746, 824	76882-1KA1A	22523	788	80850-JM01A	22107	468, 520, 798
71144-SR3-A00	18415	701	75545-0E020	25429	746, 824	76882-57A00	18265	537, 573, 799	80866-01A00	16822	18141
71592-S5D-000	20603	692	75545-0E020	25429	746, 824	76882-6P000	20886	728	80871-SN7-003	18141	423
71598-S30-013	20677	692	75545-16020	14751	823	76882-6P010	22076	728, 786	80871-ST7-000	18141	423
71728806	22432	484, 521, 691, 805	75545-30170	25429	746, 824	76882-EG01A	21285	787	80872-SN7-003	18140	423
71728806	22432	484, 521, 691, 805	75545-30170	25429	746, 824	76882-EW00B	21683	787	80872-ST7-000	18140	423
72-11-1-917-406	25406	688	75545-30170	25429	746, 824	76882-JG10A	22061	728, 787	80873-ST7-000	18137	423
72-11-1-950-829	25406	688	75545-53010	21255	746	76906-T3000	14353	478, 510, 795	80874-AX000	21646	732, 803
72311-S10-003	19673	451, 513, 709, 769, 848	75545-53011	21255	746	76913-N9900	23752	474, 522, 794	80875-85E00	18166	473, 511, 798
72311-S5S-003	21704	471, 518, 671, 709	75545-53011	21505	746	76923-47010	22072	568, 578, 757, 845	80897-7J100	22767	486, 787
72311-S5S-003	21704	471, 518, 671, 709	75545-53011	16942	823	76923-47010	22072	568, 578, 757, 845	80915-29A66	14369	550, 570, 767
72431-S2X-003	21639	668, 694	75545-53011	16821	823	76923-47010	22072	568, 578, 757, 845	80999-05N07	16784	542, 572, 799, 842
72431-S2X-003	21639	668, 694	75546-12030	16821	823	76923-52021	22502	567, 578, 757, 845	80999-VE000	21414	496, 731, 797
72826-01P00	15468	788	75546-12050	14746	823	76923-52021	22509	567, 578, 757, 845	81124-89101	16951	817
73154-TOA-003	22857	669, 698	75546-12060	19204	823	76924-02010	20578	588, 821	81126-37010	20543	479, 515, 724, 737
73154-TOA-003	22857	669, 698	75546-14080	16821	823	76924-02020	20578	588, 821	81137-22530	21628	824
73156-TOA-003	22165	699	75547-51021	21082	350	76924-02020	20578	588, 821	8-11519-408-0	21047	314
7368261	16801	195	75548-60021	22427	746, 823	76924-12030	22166	829	8-11562-588-0	21047	314
73858-AUI00	25154	351	75791-0W010	15707	499, 511, 839	76924-13020	22457	821	81174-21010	22507	727, 740
73862-672-003	14299	467, 510, 709	75819-33010	21748	745, 818	76924-47010	21217	822	81174-21010	22507	727, 740
73862-672-0030	14299	467, 510, 709	75867-02010	21226	483, 516, 835	76924-47020	22073	479, 519, 749, 829	81174-21010	22507	727, 740
73998-3TA0A	22574	787	75867-06030	21596	556, 578, 757, 845	76924-52021	20578	588, 821	81174-21010	22507	727, 740
7440A	B7440A	290	75867-06030	21596	556, 578, 757, 845	7693140	9639	436	81174-2L000	22506	727, 740
7443A	B7443A	290	75867-21010	20576	481, 515, 835	76988-3DN0A	22032	788	811-807-557-C	21510	851
7444NA	22887	287	75867-30110	19842	455, 514, 832	76988-4N000	21291	786	811-807-577-C	21510	851
74798-S9000	14695	700, 761, 782, 790, 826	75867-30120	21123	545, 576, 842	76988-JM00A	22159	822	811-807-577-C	21399	852
74816-AX000	22851	802	75867-30130	22056	483, 752, 835	76988-976	9633	436	81199-33000	25199	727, 740
74842-659-003	16779	479, 511, 705, 832	75867-30130	22056	483, 752, 835	76996-01P02	16776	454, 511, 704, 796	81199-33000	25199	727, 740
74842-659-0030	16779	479, 511, 705, 832	75867-33030	21538	483, 518, 835	76997-P7100	14723	478, 510, 795	81199-38000	25198	727, 740
74849-JD00A	22904	802	75867-33050	21596	556, 578, 757, 845	77-03-077-111	21871	481, 519, 805, 808	81199-38000	25198	727, 740
74849-JD00B	22919	803	75867-52020	22478	484, 521, 835	77-03-077-225	21806	461, 518, 807	812893	12600	216, 267
75103-SJ4-003	23818	613, 630, 768, 817	75867-52020	22478	484, 521, 835	77-03-077-435	21805	461, 518, 807	81496-0E020	22488	818
75-22-709	20454	307	75867-52020	22478	484, 521, 835	7724826	4447	429	81496-50010	22127	744
75305-S0A-003	20783	694	75867-68010	22571	484, 521, 835	77259-71B00	20744	816	81496-52020	22488	818
75305-S0A-003	20783	694	75867-AA010	21012	483, 516, 753, 836	7730788	9749	436	81496-52020	22488	818
75305-SH2-003	20784	694	75867-AA010	21012	483, 516, 753, 836	7731589	9850	446, 587	81496-52020	22488	818
75305-SH2-003	20784	694	75867-AA010	21538	483, 518, 835	7731589	10632	446	81496-60010	22398	744, 818
75305-SH4-003	20785	694	75867-AC020	21653	819	7743519	23754	625, 626	821240	18952	186
75305-SH4-003	20785	694	75891-SA7-000	25254	676, 717	77553-65D00	20743	816	82132-27100	22337	472, 521, 724
75305-SH4-003	20785	694	76222-SPI-003	21772	668, 695	77553-65D10	22079	816	82133-37000	22526	468, 521, 723
75305-SHJ-003	21186	693	76222-SPI-003	21772	668, 695	78856-R4301	14690	700, 792	82134-22000	22558	723
75306-SV1-A01	20602	694	7634583	9275	436	79101900	25196	810	82134-22000	22558	723
75306-SZA-A01	21470	693	7637192	4441	429	791084000	23971	650	82134-3L000	22591	723
75307-SN7-000	20570	110, 717, 781	7642589	13467	466, 509	796255	11349	505, 509	82134-3L000	22591	723
75315-S9A-004	22136	710	76519-60010	25430	748, 826	79796-71E00	17349	788	82135-22000	22004	498, 519, 725
75315-STK-A01	21204	668	76519-60010	25430	748, 826	79916-JD00A	25412	798, 528	82135-27000	21188	492, 516, 726, 738
75315-TG7-A01	22465	669, 694	76817-68010	22454	745, 819	7L0-839-069	21512	850	82135-27000	21188	492, 516, 726, 738
75315-TP6-A01	22465	669, 694	76817-68010	22454	745, 819	7L5-853-994	21495	482, 517, 807, 856	82315-2P000	21070	494, 516, 725, 738
75315-TP6-A01	22465	669, 694	76829-60020	25337	480, 523, 752, 835	7L6-868-243	21708	507, 518, 857	82315-2P000	22003	496, 519, 725, 738
75316-S9A-004	21557	668, 694	76829-60020	25337	480, 523, 752, 835	7L6-868-307	21875	528, 578, 806, 808	82315-2P000	22003	496, 519, 725, 738
75316-S9A-004	21557	668, 694	76847-1JB0A	22055	787	7M0-867-299-K	21853	485, 519, 742, 855	82315-2W000	22313	492, 520, 725, 738
75316-TP6-A01	22464	694	76847-JG00A	22281	788	7M3867299	21853	485, 519, 742, 855	82315-2W000	22313	492, 520, 725, 738
75329-SH4-013	21109	694	76848-35F00	22261	728, 791	7U2Z-14S411-AA	23062	248	82315-33020	22005	498, 519, 726, 739
75392-04010	21016	822	76848-54C00	22059	792	7U2Z-14S411-FA	17621	254	82315-33020	22005	498, 519, 726, 739
75392-0R010	21016	822	76848-5HA0A	22257	792	800843	12935	171	82315-33020	22005	498, 519, 726, 739
75392-35200	21016	822	76848-71S00	21622	792	801471	12922	172	82315-36000	22006	501, 519, 725
75392-35220	21857	746, 822	76848-ED000	22255	730, 793	80287-37F00	22286	476, 520, 730, 795	82315-38000	21070	494, 516, 725, 738
75392-35220	21857	746, 822	76848-JG00A	22257	792	8-03536-966-0	18665	303	823-867-299	20252	505, 514, 856
75392-42030	21841	44, 58, 92, 101	76853-10010	21586	822	803716-S	14018	546, 570, 641	823-867-299	20252	505, 514, 856
75392-60030	20877	745	76876-W5000	14352	475, 510, 794	803916010	21677	309	82711-2200	21553	299, 847
75392-60031	20877	745	76879-44010	21611	847	807016160	21326	318			
75394-60060	20875	745	76881-5HA0A	22239	790	80850-1FA0B	22875	470, 521, 798			
75395-0T010	21453	818	76881-JG00A	22239	790	80850-89900	21633	518, 731, 798			
75395-33030	19900	744									
75395-35070	20688	820									
75396-35020	20687	819									
75397-33010	20661	744									
75397-33010	20688	820									
75397-42010	22215	820									
75494-42010	22255	821									
75495-35010	20687	819									
75498-42010	19843	820									
75521-611-000	14274	700, 761, 789, 824									

O.E.M. INTERCHANGE BY NUMERICAL ORDER

OEM No.	Auveco No.	Page No.	OEM No.	Auveco No.	Page No.	OEM No.	Auveco No.	Page No.	OEM No.	Auveco No.	Page No.
88861017	5225	214	88862274	19555	237	88987992	22936	233,	8-94226-492-0	14269	498,
88861018	8759	214	88862279	23198	271,			278		510, 733, 764,	838
88861020	8761	214,			273	88987993	23016	234,	8942-431-900	14369	550,
		241	88862280	23081	231			257			570, 767
88861022	17690	237	88862281	23260	230,	88988117	23059	244	89427-98070	16775	458,
88861047	5196	141			240	88988139	23061	244		511, 704,	796
88861048	23111	281	88862282	23187	285	88988301	18527	232,	894-298-119-0	14696	531,
88861049	23220	282	88862283	23050	229			256		570, 713, 733,	798
88861050	8764	214	88862284	23124	224,	88988447	19582	251	8-94328-493-2	14727	569,
88861067	23155	275			235, 239	88988609	21212	228		571, 733,	801
88861068	23263	285	88862285	23264	285	88988620	18529		8-94467-458-4	17355	437,
88861069	23125	284	88862286	23259	231	88988963	24202	223,			733
88861070	23189	285	88862287	23053	226,			249, 260	8955-022-134	15042	571
88861071	23188	285			234	8900524	11948	191	8-97084-563-0	24208	329
88861072	23119	259	88862288	23261	240	8901283	11166	241,	8-97134-978-0	17355	437,
88861073	13548	223	88862290	23054	231			280			733
88861073	23141	224	88862292	23190	220,	8902487	11446	215	8-97214-872-0	18661	288
88861075	20561	263			230, 235	89025539	20485	621	8-97286-997-0	16897	288
88861076	23193	255	88862295	23265	230	89025546	21072	621	8D0-805-121	21889	859
88861078	20843	251	88862296	19813	262	8903202	11154	215	8E0-821-989-A	22824	850
88861079	23215	246	88862300	23219	246	8903202	11475	215	8E0-837-485-D	25415	854
88861080	23216	246	88862301	20846	250	8903203	11476	215	8E0-864-229-9B9	22444	860
88861082	23217	246	88862302	17463	221	8903283	11446	215	8E0-868-243	21144	507,
88861083	23218	246	88862303	16968	221,	8903489	12628	202			516, 856
88861084	20845	257			248, 269, 277	8904437	11156	215	8K0-805-121	21887	859
88861085	23202	259	88891731	19424	623	89046837	23211	224	8K0-805-922A	22260	861
88861087	23195	245	88891787	21047	314	89057707	18218	250	8K0-821-213A	22308	853
88861089	20853	253	88891787	24265	315	89057711	17620	251	8K0-837-199	22719	851
88861090	23269	249,	88891791	18889	357	89057714	13548	223	8K0-868-307	22420	536,
	255, 260, 270, 272,	273	88909758	12548	213	89057715	23196	231,			579, 858
88861091	20851	250	88909760	12536	213			255, 272	8L3-837-199-B	22397	569,
88861092	23203	266	88909760	12550	213	89057717	20838	250			579, 858
88861093	23201	246,	88909761	12551	213	89057718	19887	262	8R0-853-909	22414	850
		259, 266	88909762	12552	213	89057721	11440	231,	8T0-853-909-A	22426	849
88861094	20842	248	88909763	12553	213			272	8U0-853-909	22417	485,
88861094	23199	249	88909764	12554	213	89057722	11442	223			521, 855
88861095	20848	242	88909765	12555	213	89057794	20471	298,	8V0-853-585	22823	849
88861096	20852	251	88909766	12556	213			611	8V0-868-243	22442	857
88861099	23126	284	88909769	12547	213	8909518	11156	215	8W0-805-121	21887	859
88861101	5226	214	88909770	15505	213	8909908	11446	215	8Z0-857-784	21875	528,
88861106	23196	231,	88909771	15506	213	8911472	14546	298,			578, 806, 808
		255, 272	88909772	15507	213			611	900.123.003.20	23914	118
88861107	23096	222,	88909773	15508	213	8911473	14544	298,	900.123.004.20	23915	118
		248, 269, 277	88909774	15509	213			611	900.123.028.20	23911	118
88861108	23109	281	8891030	15673	620,	8911497	14545	298	900.123.101.30	23926	118
88861353	12552	213			662	8912698	11157	215,	900.123.104.30	23927	118
88862211	16514	224	8891031	15673	620,			267	90001-SG0-003	14291	474,
88862213	18217	253,			662	8912750	13540	216			510, 703
		261	88938226	14921	449,	8913369	14885	197	90009-PHI-000	21353	315
88862214	14580	232			510	8914822	11154	215	90009-PHI-000	21353	315
88862215	17112	226,	88953146	23134	220,	8914822	11475	215	90009-PY3-000	22205	317
		253			276	8914823	11476	215	90009-R70-A00	22205	317
88862216	17109	223	88953267	22776	224,	8915135	23010	202	90009-R70-A00	22205	317
88862217	16694	217,			228, 238, 270, 274	8915136	12628	202	90012300730	23927	118
		242, 276	88961517	12669	116,	8917283	17002	192	90058568	23859	522
88862218	17107	232			151	8917320	14547	298,	90066-PC8-010	24222	321
88862219	18918	221	88969790	20576	481,			612	90075-10004	21628	824
88862220	16693	232,			515, 835	8917444	11083	205	90075-10801	19783	631,
		256	88970345	20559	493,	8918527	9883	215,			747, 825
88862221	23079	226			515, 753, 836			241, 280	90075-10805	19783	631,
88862222	23145	235	88970493	17481	819	8918527	11166	241,			747, 825
88862223	16967	220,	88970494	20577	549,			280	90075-60060	25291	276
		227, 284			575, 599, 755, 843	8919916	13543	216	90080-46010	21296	474,
88862226	17110	232,	88970495	20578	588,	8933059	10318	588			517, 831
		254, 266			821	8933059	11288	587	90080-46269	19797	819
88862227	18917	233	88970656	20575	496,	8934-201-262	11855	583,	90080-46294	21325	537,
88862228	17111	227			515, 753, 837			807			577, 842
88862229	17114	221	88970747	19729	476,	8934-201-263	9377	649,	90080-46327	22221	476,
88862230	17113	224			514, 751, 833			807			520, 832
88862232	16964	232	88970766	21687	759,	8934201287	16826	63,	90080-81041	16897	288
88862233	23158	225			848			67, 80, 84	90080-82014	12540	213
88862235	17683	256	88970767	20869	463,	8934-201-287	16826	63,	90080-82050	21603	213
88862238	18527	232,			516, 540, 576,			67, 80, 84	90080-82051	21436	213
		256			604, 750, 755	8934-201-602	12713	585,	90080-82051	21436	213
88862238	23034	234,	88973654	20578	588,			650, 807	90080-82052	21437	213
		257			821	8934-201-621	14007	539,	90080-82052	21437	213
88862241	13644	237,	88973676	20577	549,			570, 602, 657	90080-82053	21166	213
		261			575, 599, 755, 843	8934-201-631	13750	342	90080-82055	21438	213
88862247	17690	237	88974848	20575	496,	8934-201-681	13475	505,	90080-82055	21438	213
88862254	23196	231,			515, 753, 837			509, 808, 856	90084-26001	17420	346
		255, 272	88981030	15674	620,	8934-201-767	13966	141,	90084-26002	20383	351
88862255	18674	232			662			807	90084-26008	17411	346
88862257	23179	229	88981031	15673	620,	8934-201-835	17496	341	90084-46020	21071	821
88862260	18870	233,			662	8934-202-293	16251	140	90084-98033	18661	288
		253, 256	88986416	23127	219,	8934-202-599	17102	488,	90099-14044	18136	423
88862261	23045	277,			276			511	90099-14045	18143	423
		283	88986451	18868	233	894-133-167-0	23807	522,	90101-SHJ-A01	25064	670,
88862262	17199	228	88986460	25210	227,			733			702
88862264	21490	218,			236, 278, 279	8-94134-027-0	14739	733,	90101-SHJ-A01	25064	670,
		237, 243, 263, 268, 274	88987184	23053	226,			825			702
88862267	19882	237,			234	8-94145-515-0	17076	459,	90101-TRO-000	22941	83,
		257, 262	88987185	23262	240			511, 733			676, 717
88862269	23256	221,	88987187	21220	218,	8-94218-027-0	17195	630,	90101-TRO-000	22941	83,
		230			276			651, 692, 733, 782			676, 717
88862270	23092	231	88987962	17109	223	8-94221-150-0	14727	569,	90103-SDA-A00	22203	44,
88862271	18925	221						571, 733, 801			57, 92, 100

O.E.M. INTERCHANGE BY NUMERICAL ORDER

OEM No.	Auveco No.	Page No.	OEM No.	Auveco No.	Page No.	OEM No.	Auveco No.	Page No.	OEM No.	Auveco No.	Page No.
90103-SDA-A00	22203	44, 57, 92, 100	90189-06028	19194	584, 827	90430-12031	22134	310	90467-06192	22487	752, 832, 833
90103-TA0-000	22203	44, 57, 92, 100	90189-06029	19505	827	90430-12031	24347	310	90467-06192	22487	752, 832, 833
90105-06037	21840	80, 83	90189-06042	14695	700, 826	90430-18023	24371	304	90467-06205-C0	22495	751
90105-TBA-A00	25224	84, 676	90189-06065	761, 782, 790, 20440	828	90430-24003	25084	307	90467-06205-C0	22495	751
90105-TBA-A00	25224	84, 676	90189-06066	25433	617, 826	90430-C0005	22134	310	90467-07041	17162	532, 841
90106-SW3-003	19650	701	90189-06066	651, 747, 25433	617, 826	90441-PK4-000	24320	306	90467-07041-B0	17162	532, 841
90106-SW3-003	19650	701	90189-06076	22213	827	90450482	25222	558, 777	90467-07041-B0	19162	147
90107-SOX-A01	21521	670, 701	90189-06084	19505	827	90467 10168	18950	497, 512, 837	90467-07041-B2	17162	532, 841
90107-SOX-A01	21521	670, 701	90189-06104	19742	747, 827	90467-04023	23945	113, 848	90467-07041-C0	17162	532, 841
90107-S10-003	19533	701	90189-06111	19783	631, 825	90467-04032	22214	474, 520, 831	90467-07042-C0	21560	454, 763
90108-S00-003	20331	692	90189-06114	20412	828	90467-04034	21552	469, 518, 523, 752, 834	90467-07043	16784	542, 842
90108-S00-003	20331	692	90189-06116	19505	827	90467-05020	19506	452, 513, 672, 704	90467-07043-II	16784	542, 842
90108-SW3-003	19470	454, 513, 704	90189-06145	21625	747, 827	90467-05020	19506	452, 513, 672, 704	90467-07043-C0	16784	542, 842
90108-SW3-003	19470	454, 513, 704	90189-06157	19721	828	90467-05020-01	19506	452, 513, 672, 704	90467-07044	19128	550, 844
90109-SW3-003	19470	454, 513, 704	90189-06172	19505	827	90467-05045-22	19686	449, 514, 830	90467-07045-22	23948	828
901108-994-00	23918	118	90189-06177	21411	828	90467-05063-C0	21218	525, 577, 840	90467-07050	14737	475, 831
90111-SM4-003	22942	83, 676, 717	90189-06193	20895	825	90467-05081	21615	114, 759, 849	90467-07059-22	19013	531, 841
90111-SM4-003	22942	83, 676, 717	90189-06211	21331	826	90467-05090-B1	21103	525, 576, 840	90467-07066	17383	526, 840
90114-SE0-000	20259	44, 55, 92, 99	90189-06214	19756	827	90467-05096-22	19312	452, 513, 830	90467-07066-14	17383	526, 840
90114-SZ3-000	20259	44, 55, 92, 99	90189-06228	20412	828	90467-05114	20956	114, 147, 759, 848	90467-07066-14	17383	526, 840
90116-S82-A01	19439	555, 767, 845	90189-06236	21792	827	90467-05114	20956	114, 147, 759, 848	90467-07066-22	17383	526, 840
90118-WB048	22424	555, 767, 845	90189-06237	20895	825	90467-05125	21693	452, 518, 750	90467-07066-22	17383	526, 840
90159-50316	21839	44, 58, 92, 101	90189-06238	22566	826	90467-05125	21693	452, 518, 750	90467-07071-22	21249	526, 840
90159-60303	22106	45, 59, 92, 103	90189-09002	22939	826	90467-05128	21614	114, 848	90467-07072	14697	529, 765
90159-60488	21838	45, 60, 93, 105	90189-A0002	20440	828	90467-05136	21849	528, 578, 754, 840	90467-07072-22	14697	529, 765
90159-60498	25078	45, 61, 93, 105	90189-A0002	21605	747, 827	90467-05138	21687	759, 848	90467-07076	17162	532, 841
90159-60498	25078	45, 61, 93, 105	90189-A0008	21625	747, 827	90467-05138	21687	759, 848	90467-07076-C0	17162	532, 841
90159-60525	21837	45, 62, 93, 105	90189-A0011	19742	747, 827	90467-05162-C0	25075	450, 522, 750, 830	90467-07085	23943	541, 842
90159-A0001	21839	44, 58, 92, 101	90189-A0011	19742	747, 827	90467-05162-C0	25075	450, 522, 750, 830	90467-07096	19124	478, 832
90159-A0030	21838	45, 60, 93, 105	90189-A0011	19742	747, 827	90467-05164	21332	517, 830	90467-07117	18270	538, 755
90159-A0030	21838	45, 60, 93, 105	90189-A0011	19742	747, 827	90467-05164-B6	21253	454, 517, 830	90467-07121	19908	549, 843
90179-05060	17993	113	90189-A0011	19742	747, 827	90467-05164-E2	21332	517, 830	90467-07121-B2	19907	549, 843
90183-03001	16306	847	90189-A0011	19742	747, 827	90467-05170	22125	524, 579, 754, 840	90467-07121-B2	19908	549, 843
90185-06006	14265	826	90189-A0011	19742	747, 827	90467-05170	22125	524, 579, 754, 840	90467-07121-C0	19908	549, 843
90189-04007	23729	825	90189-A0011	19742	747, 827	90467-06005	22472	846	90467-07121-C0	19908	549, 843
90189-04008	14277	825	90189-A0011	19742	747, 827	90467-06005	22472	846	90467-07126	19535	748, 828
90189-04011	14271	824	90189-A0011	19742	747, 827	90467-06015-C0	22214	520, 831	90467-07138	17992	552, 572
90189-04013	14268	700, 826	90189-A0011	19742	747, 827	90467-06017	14260	532, 570, 599, 766, 841	90467-07138-C0	17992	552, 572
90189-04014	14256	824	90189-A0011	19742	747, 827	90467-06017-41	14260	532, 570, 599, 766, 841	90467-07138-C0	17992	552, 572
90189-04019	14263	826	90189-A0011	19742	747, 827	90467-06017-C0	14260	532, 570, 599, 766, 841	90467-07164	19552	535, 841
90189-04057	14271	824	90189-A0011	19742	747, 827	90467-06128	21626	474, 518, 831	90467-07164	20908	551, 844
90189-04066	14281	700, 827	90189-A0011	19742	747, 827	90467-06133	20196	529, 575, 840	90467-07166	18888	550, 844
90189-04102	21544	747, 825	90189-A0006	20788	348	90467-06133-C0	20196	529, 575, 840	90467-07168	20577	549, 843
90189-04176	19840	825	90189-A0006	20788	348	90467-06150	19490	540, 573, 842	90467-07168-C1	20577	549, 843
90189-04231	25431	747, 825	90189-A0006	20788	348	90467-06158-C0	25434	758, 849	90467-07188	21011	534, 841
90189-04231	25431	747, 825	90189-A0006	20788	348	90467-06161-01	14736	475, 510, 831	90467-07190-B2	21104	529, 840
90189-05012	14739	733, 825	90189-A0006	20788	348	90467-06175	21560	454, 518, 763	90467-07192	21120	533, 841
90189-05013	13932	782, 824	90189-A0006	20788	348	90467-06183	25435	758, 848	90467-07195	23958	534, 841
90189-05105	20431	825	90189-A0006	20788	348	90467-06183	25435	758, 848	90467-07195	23959	550, 841
90189-05105	23560	825	90189-A0006	20788	348	90467-06183	25435	758, 848			
90189-05142	21191	826	90189-A0006	20788	348						
90189-06001	14275	783, 790, 827	90189-A0006	20788	348						
90189-06005	14273	748, 828	90189-A0006	20788	348						
90189-06006	14265	826	90189-A0006	20788	348						
90189-06010	14274	700, 761, 789, 824	90189-A0006	20788	348						
90189-06013	14267	748, 828	90189-A0006	20788	348						
90189-06018	14258	825	90189-A0006	20788	348						
90189-06027	25432	747, 828	90189-A0006	20788	348						
90189-06027	25432	747, 828	90189-A0006	20788	348						
			90189-06028	19194	584, 827						
			90189-06029	19505	827						
			90189-06042	14695	700, 826						
			90189-06065	761, 782, 790, 20440	828						
			90189-06066	25433	617, 826						
			90189-06076	22213	827						
			90189-06084	19505	827						
			90189-06104	19742	747, 827						
			90189-06111	19783	631, 825						
			90189-06114	20412	828						
			90189-06116	19505	827						
			90189-06145	21625	747, 827						
			90189-06157	19721	828						
			90189-06172	19505	827						
			90189-06177	21411	828						
			90189-06193	20895	825						
			90189-06211	21331	826						
			90189-06214	19756	827						
			90189-06228	20412	828						
			90189-06236	21792	827						
			90189-06237	20895	825						
			90189-06238	22566	826						
			90189-09002	22939	826						
			90189-A0002	20440	828						
			90189-A0002	21605	747, 827						

O.E.M. INTERCHANGE BY NUMERICAL ORDER

OEM No.	Auveco No.	Page No.	OEM No.	Auveco No.	Page No.	OEM No.	Auveco No.	Page No.	OEM No.	Auveco No.	Page No.
90467-07201	20955	756, 844	90467-09051	25076	478, 522, 751, 833	90467-12078	16779	479, 511, 705, 832	90565-TZ5-003	25065	470, 522, 671, 710
90467-07201	20955	756, 844	90467-09093	17439	535, 572, 754	90467-12078-01	16779	479, 511, 705, 832	90601-S30-003	22926	670, 702
90467-07208	22598	453, 521, 750	90467-09096	19219	535, 573, 755, 845	90467-12080	21549	744, 817	90601-S30-003	22926	670, 702
90467-07211	21201	547, 577, 756	90467-09101	18939	546, 573, 754	90467-12096	14277	825	90601-SH3-014	17442	696
90467-07211	21201	547, 577, 756	90467-09127	19739	559, 573, 704, 845	90467-13005	17194	817	90601-SMG-003	22242	693
90467-07214	21294	550, 577, 844	90467-09128	23891	560, 580	90467-13008	17194	817	90601-SNV-P01	25267	670, 701
90467-07215	22439	844	90467-09139	19416	544, 573, 713, 766, 842	90467-13011	17195	630, 651, 692, 733, 782	90602-S2A-003	21696	480, 518, 705
90467-07217	22400	755, 843, 845	90467-09143	17988	548, 572	90467-13075	21623	782, 817	90602-S5A-003	21059	501, 516, 674, 708
90467-07217	22400	755, 843, 845	90467-09145	17206	532, 572, 841	90467-14053	22708	757, 847	90602-S7S-003	20611	480, 515, 705
90467-07220	22567	553, 579, 756	90467-09166	21010	551, 576, 844	90467-17004	17438	817	90602-SAA-003	21087	499, 516, 707
90467-07222	25338	548, 580, 756, 843	90467-09169-C0	22395	751, 832	90467-22014	22569	821	90602-SEP-A00	21131	503, 516, 674
90467-07222	25338	548, 580, 756, 843	90467-09169-C0	22395	751, 832	90467-22017	25346	479, 523, 749, 829	90602-SJK-003	22560	695
90467-08004	18297	474, 512, 750, 831	90467-09185	21547	542, 577, 755, 842	90467-22017	25346	479, 523, 749, 829	90602-SLJ-003	23978	673, 706
90467-08008	14737	475, 510, 795, 831	90467-09185	21547	542, 577, 755, 842	90467-A0002-C0	22473	750, 830	90602-SX0-003	21107	483, 516, 673, 706
90467-08011	18297	474, 512, 750, 831	90467-09204	21546	744, 817	90467-A0002-C0	22473	750, 830	90602-SX0-003	21107	483, 516, 673, 706
90467-08011-83	18297	474, 512, 750, 831	90467-09206	20437	496, 515, 837	90467-A0002-C4	22473	750, 830	90602-TA0-003	21417	673, 706
90467-08014	19121	458, 513, 831	90467-09212	21410	491, 517, 836	90467-A0003	19113	476, 512, 751, 833	90602-TA0-003	21417	673, 706
90467-08014-01	19121	458, 513, 831	90467-09227	21366	562, 577, 845	90467-A0003	19113	476, 512, 751, 833	90617-TBA-A01	22262	692
90467-08045	21695	474, 518, 831	90467-09232	22845	501, 754, 840	90467-A0004	22350	746, 820	90650-T2A-003	25067	692
90467-08063	21695	474, 518, 831	90467-09237	22353	749, 829	90467-A0004	22350	746, 820	90651-S4N-003	19749	471, 514, 834
90467-08081	18878	477, 512, 833	90467-09237	22353	749, 829	90467-A0004	22350	746, 820	90651-T2M-003	22553	467, 521, 709
90467-08101	21643	475, 518, 751, 831	90467-09242	22568	562, 579, 757	90467-A0005	21102	497, 516, 753, 838	90651-T3L-003	22469	501, 521, 674, 708
90467-08108	21643	475, 518, 751, 831	90467-10018	14347	478, 510, 795, 832	90467-A0005	21102	497, 516, 753, 838	90651-T3L-003	22469	501, 521, 674, 708
90467-08124	19113	476, 512, 751, 833	90467-10077	19797	819	90467-A0006	18876	498, 512, 837	90651-TA0-003	22551	472, 521, 671, 709
90467-08136	21254	479, 517, 832	90467-10107	19123	476, 513, 833	90467-A0007	22471	752	90651-TG7-000	22586	449, 521, 709
90467-08145	16000	550, 571, 714, 767, 800	90467-10146	19728	472, 514, 834	90467-A0008	20878	458, 516, 750, 830	90651-TP8-003	21705	471, 518, 671, 709
90467-08155	19140	558, 573, 599, 656, 676, 785, 845	90467-10161	18876	498, 512, 837	90467-A0008	20878	458, 516, 750, 830	90652-SB2-023	16949	715
90467-08179	19910	499, 514, 837	90467-10162	18861	481, 512, 835	90467-A0009	18297	474, 512, 750, 831	90653-HC4-900	17222	534, 572, 603, 640
90467-08185	20349	542, 575, 666, 755, 799, 842	90467-10167	20559	497, 515, 753, 836	90467-A0009	18297	474, 512, 750, 831	90655-SA0-003	14288	699
90467-08186	20184	453, 514, 830	90467-10168	18950	497, 515, 753, 836	90467-A0016-C0	17162	532, 572, 601, 841	90655-SA0-0030	14288	699
90467-08186-C0	20184	453, 514, 830	90467-10170-C0	21702	543, 578, 755, 843	90467-A0016-C0	17162	532, 572, 601, 841	90656-671-6310MI	14287	700
90467-08186-C3	20184	453, 514, 830	90467-10170-C0	21702	543, 578, 755, 843	90467-A0018	21615	114, 759, 849	90657-SA5-003	22199	532, 579, 674, 710
90467-08188	22369	750, 830	90467-10173	19123	476, 513, 833	90467-A0032	22455	752	90657-SA6-003	14697	529, 570, 599, 713, 765
90467-08188	22369	750, 830	90467-10181	22351	744, 818	90468-04030	16671	847	90657-SB0-003	19186	525, 573, 674, 710
90467-08188	22369	750, 830	90467-10181	22351	744, 818	90468-04038	16306	847	90661-SC7-003	14695	700
90467-08196	21846	745, 820	90467-10183	20869	463, 516, 540, 576, 604, 750, 755	90471-PX4-000	16955	306	90662-671-003	14313	700, 761, 782, 790, 826
90467-08217	19239	552, 580, 606, 675, 711, 756, 785	90467-10183	20869	463, 516, 540, 576, 604, 750, 755	90501-SDR-003	22419	558, 676, 712	90662-693-003	14281	700, 827
90467-08217	19239	552, 580, 606, 675, 711, 756, 785	90467-10186	21634	476, 518, 751, 837	90501-SDR-003	22419	558, 676, 712	90662-SB2-003	14313	700, 761, 789
90467-08224	22396	745, 819	90467-10188	20633	492, 515, 666, 838	90501-SJA-A01	25115	671, 702	90664-671-003	14328	510, 709
90467-08224	22396	745, 819	90467-10190	21537	745	90501-SJA-A01	25115	671, 702	90664-SB3-003	20303	701
90467-08225	22217	819	90467-10192	20558	492, 515, 753, 836	90505-SLO-003	19140	558, 573, 599, 656, 676, 785, 845	90665-S47-003	21414	496, 731, 797
90467-09004	19112	477, 512, 833	90467-10206	21624	535, 578, 754, 841	90505-SM4-003	17057	546, 572, 714	90665-S47-003	21414	496, 731, 797
90467-09004-01	19112	477, 512, 833	90467-10216	25259	554, 756, 848	90505-SX0-003	19453	574, 666	90665-SM4-000	19646	700
90467-09006	18842	477, 512, 833	90467-11005	14353	478, 510, 795	90520-01002	2288	435	90666-SA0-003	14289	451, 510, 704
90467-09008	14738	477, 510, 833	90467-11063	17481	819	90520-01274	2288	435	90666-SA0-0030	14289	451, 510, 704
90467-09008-01	14738	477, 510, 833	90467-11099	21550	819	90520-01274	23785	435, 491, 521	90666-SA0-003A3	14289	451, 510, 704
90467-09008-01	14738	477, 510, 833	90467-11100	20429	820	90541-09069	22413	820	90666-SA0-003A9	14289	451, 510, 704
90467-09050	19729	476, 514, 751, 833	90467-11117	22051	748, 824	90541-09124	22490	820	90666-SA0-003ZD	14289	451, 510, 704
90467-09051	25076	478, 522, 751, 833	90467-12020	23818	613, 630, 768, 817	90541-09124	22490	820	90666-SA0-003ZD	14289	451, 510, 704
			90467-12075	21642	821	90543942	24355	303	90666-SA7-003ZW	19506	452, 513, 672, 704
						90560163	22336	491, 521	90666-SD9-000	20351	699
						90561-13003	22709	757, 847	90666-SDA-A01	22546	668, 693
						90561-A0001	22843	757, 848	90666-SDA-A01	22546	668, 693
						90565-TZ5-003	25065	470, 522, 671, 710	90666-TA0-A01	25326	668, 693

O.E.M. INTERCHANGE BY NUMERICAL ORDER

OEM No.	Auveco No.	Page No.	OEM No.	Auveco No.	Page No.	OEM No.	Auveco No.	Page No.	OEM No.	Auveco No.	Page No.
90666-TA0-A01	25326	668, 693	906A	B906A	290	909300015	21569	810	91502-SM4-000	19407	560, 573, 715
90667-671-013ZA	20381	476, 515, 703, 783, 795	90700-SB2-003	15998	464, 511, 704	90950-01620	22097	847	91502-SP0-003	18119	559, 573, 715
90667-S0D-003ZC	20334	454, 515, 703	90700-SJ4-000	18746	466, 512, 672, 704	90950-01620	22097	847	91502-SZ5-003	19232	538, 573, 674
90667-SA0-003	16776	454, 511, 704, 796	90713-SB0-003	14705	698	90950-08004	22159	822	91502-TZ5-A01	21421	464, 517, 812
90667-SA0-0030	16776	454, 511, 704, 796	90814FC001	21322	811	90959-01136	17631	846	91503-S0K-A01	20608	555, 575, 712
90667-SA7-003	16775	458, 511, 704, 796	90820-SNA-003	25068	677, 716	90980-11875	25160	223, 249, 277	91503-S3Y-003	21419	695
90667-SA7-003ZB	16775	458, 511, 704, 796	90820-SNA-003	25068	677, 716	90981-11067	16921	286	91503-S7A-003	21297	552, 577, 711
90668-SB0-003	14698	542, 570, 714	90825-T2A-003	25327	677, 716	90981-11069	B7443	290	91503-S7A-003	21297	552, 577, 711
90669-SP0-003ZA	19744	454, 514	90825-T2A-003	25327	677, 716	90981-13018	20600	288	91503-SP0-003	17267	556, 572, 676
90669-SP0-003ZB	19744	454, 514	90825-T2A-003	25327	677, 716	90981-13046	B9005	291	91503-SP0-003	17267	556, 572, 676
90670-SG0-003	19741	700	90825-T2A-003	25327	677, 716	90981-13046	16897	288	91503-SWA-A01	22466	669, 696
90671-S0D-003YU	21303	452, 517, 703	90825-T2A-003	25327	677, 716	90981-13046	B9005	291	91503-SZ3-003	19233	554, 573, 675, 711
90671-S0D-003ZK	21303	452, 517, 703	90825-T2A-003	25327	677, 716	90981-13047	B9006	292	91503-SZ3-003	19233	554, 573, 675, 711
90671-SDA-A01	20740	355	90825-T2A-003	25327	677, 716	90981-13055	18661	288	91503-SZ5-003	20564	557, 575, 675, 712
90672-671-003	18157	475, 511, 703	90825-T2A-003	25327	677, 716	90981-13063	BH7	292	91503-SZ5-003	20564	557, 575, 675, 712
90672-671-8110M1	14268	700, 826	90825-T2A-003	25327	677, 716	90981-13075	BH11	292	91503-SZ5-003	20564	557, 575, 675, 712
90672-SA0-003	14298	299, 716, 769	90825-T2A-003	25327	677, 716	90981-13075	BH11	292	91503-T1W-003	22446	554, 579, 711
90672-SA0-0030	14298	299, 716, 769	90825-T2A-003	25327	677, 716	90981-13082	15926	211	91503-T2A-A01	21796	696
90672-SNA-A01	22548	715	90825-T2A-003	25327	677, 716	90981-13082	15926	211	91503-TK8-A01	22587	696
90673-SC6-003	14703	698	90825-T2A-003	25327	677, 716	90981-13082	15926	211	91503-TLY-H01	25255	696
90673-SC6-0030	14703	698	90825-T2A-003	25327	677, 716	90981-13082	15926	211	91503-TR0-A01	25329	696
90673-TY2-A01	25262	676, 717	90825-T2A-003	25327	677, 716	90981-13082	15926	211	91504-SDA-003	22518	715
90673-TY2-A01	25262	676, 717	90825-T2A-003	25327	677, 716	90981-13082	15926	211	91504-SM4-000	17144	559, 572, 714
90674-SB0-000	14268	700, 826	90825-T2A-003	25327	677, 716	90981-13082	15926	211	91504-SM4-000	19408	559, 573, 714
90674-TY2-A01	22943	676, 717	90825-T2A-003	25327	677, 716	90981-13082	15926	211	91504-SPI-003	21558	668, 695
90674-TY2-A01	22943	676, 717	90825-T2A-003	25327	677, 716	90981-13082	15926	211	91504-SPI-003	21558	668, 695
90675-SA5-003	22105	116, 152, 717	90825-T2A-003	25327	677, 716	90981-13082	15926	211	91504-TBA-A01	22263	476, 520, 703
90675-SA5-003	22105	116, 152, 717	90825-T2A-003	25327	677, 716	90981-13082	15926	211	91505-S9A-003	20986	554, 576, 711
90675-SB0-003	16000	550, 571, 714, 767, 800	90825-T2A-003	25327	677, 716	90981-13082	15926	211	91505-S9A-003	20986	554, 576, 711
90675-SB3-003	16000	550, 571, 714, 767, 800	90825-T2A-003	25327	677, 716	90981-13082	15926	211	91505-SL0-003	19231	544, 573, 675
90676-SA7-003	17058	699	90825-T2A-003	25327	677, 716	90981-13082	15926	211	91505-SL0-003	19231	544, 573, 675
90676-SR4-003	18115	702	90825-T2A-003	25327	677, 716	90981-13082	15926	211	91505-T5A-003	25268	717
90677-671-003	14687	715	90825-T2A-003	25327	677, 716	90981-13082	15926	211	91505-TM8-003	21706	555, 578, 675, 712
90677-693-003	14687	715	90825-T2A-003	25327	677, 716	90981-13082	15926	211	91505-TM8-003	21706	555, 578, 675, 712
90682-SB0-003	17058	699	90825-T2A-003	25327	677, 716	90981-13082	15926	211	91505-TM8-003	21706	555, 578, 675, 712
90682-SDA-A01	21205	701	90825-T2A-003	25327	677, 716	90981-13082	15926	211	91505-TY2-003	22703	567, 580, 715
90682-SDA-A01	21205	701	90825-T2A-003	25327	677, 716	90981-13082	15926	211	91506-S9A-003	21173	556, 577, 675, 712
90682-SEA-003	20954	670, 701	90825-T2A-003	25327	677, 716	90981-13082	15926	211	91506-S9A-003	21173	556, 577, 675, 712
90682-SEA-003	20954	670, 701	90825-T2A-003	25327	677, 716	90981-13082	15926	211	91507-SH3-003	17632	542, 572, 638, 726, 766
90683-693-000	14690	700, 792	90825-T2A-003	25327	677, 716	90981-13082	15926	211	91508-S50-003	19547	538, 573, 710
90683-SA5-003	19311	533, 573, 713	90825-T2A-003	25327	677, 716	90981-13082	15926	211	91508-SM4-003	17192	543, 572, 711
90684-SA5-003	14696	531, 570, 713, 733, 798	90825-T2A-003	25327	677, 716	90981-13082	15926	211	91508-SR3-000	18165	538, 573, 711
90685-SA5-003	14356	479, 510, 795	90825-T2A-003	25327	677, 716	90981-13082	15926	211	91512-S50-003	21555	668, 695
90687-671-003	14319	479, 510, 705	90825-T2A-003	25327	677, 716	90981-13082	15926	211	91512-S50-003	21555	668, 695
90687-671-003	14319	479, 510, 705	90825-T2A-003	25327	677, 716	90981-13082	15926	211	91512-S50-003	21555	668, 695
90687-SA5-003	14282	475, 510, 703	90825-T2A-003	25327	677, 716	90981-13082	15926	211	91512-SED-003	22514	706
90687-SA5-0030	14282	475, 510, 703	90825-T2A-003	25327	677, 716	90981-13082	15926	211	91512-SED-003	22514	706
90687-SB0-003	17287	528, 572, 713	90825-T2A-003	25327	677, 716	90981-13082	15926	211	91512-SJ6-J01	21559	668, 694
90687-SB0-013	17287	528, 572, 713	90825-T2A-003	25327	677, 716	90981-13082	15926	211	91512-SJ6-J01	21559	668, 694
90687-SB2-901ZF	17287	528, 572, 713	90825-T2A-003	25327	677, 716	90981-13082	15926	211	91512-SJK-003	22069	554, 578, 675, 712
90688-SB0-003	14698	542, 570, 714	90825-T2A-003	25327	677, 716	90981-13082	15926	211	91512-SJK-003	22069	554, 578, 675, 712
90688-SB0-013	14698	542, 570, 714	90825-T2A-003	25327	677, 716	90981-13082	15926	211	91512-SM4-003	17379	551, 572, 714
90688-SB0-013	14698	542, 570, 714	90825-T2A-003	25327	677, 716	90981-13082	15926	211	91512-SR3-004	20472	110, 671, 702
90688-SB0-013	14698	542, 570, 714	90825-T2A-003	25327	677, 716	90981-13082	15926	211	91512-STK-A01	22112	554, 578, 675, 712
90688-SB0-013	14698	542, 570, 714	90825-T2A-003	25327	677, 716	90981-13082	15926	211	91512-STK-A01	22112	554, 578, 675, 712
90688-SB0-013	14698	542, 570, 714	90825-T2A-003	25327	677, 716	90981-13082	15926	211	91512-STK-A01	22112	554, 578, 675, 712
90688-SB0-013	14698	542, 570, 714	90825-T2A-003	25327	677, 716	90981-13082	15926	211	91512-SX0-003	19239	552, 580, 606, 675, 711, 756, 785

O.E.M. INTERCHANGE BY NUMERICAL ORDER

OEM No.	Auveco No.	Page No.	OEM No.	Auveco No.	Page No.	OEM No.	Auveco No.	Page No.	OEM No.	Auveco No.	Page No.
9441866	17999	286	9669486	11855	583,	9928-90-753	14376	298,			
9441941	2808	21			807			768			
9441956	18005	286	96706-89901	14366	761,	9928-91-053	14298	299,			
9442003	17996	286			790			716, 769			
9442081	17997	286	96706-B0700	13930	761,	9956-41-400	19621	306			
9442361	17641	355			789	9956-41-400	23442	118			
9442486	18001	286	96706-H2500	14724	790	9956-41-800	24317	306			
9442492	18478	287	96706-H9400	14335	782,	9957-83-000	25114	762			
9442879	20633	288			790	99604-H1400	16780	802,			
9442881	20599	288	96706-K1300	14335	782,			846			
94467458	17355	437,			790	9991-00-402	14366	761,			
		733	96706-K1351	14335	782,			790			
94530387	25054	611			790	9991-00-412	13930	761,			
94530438	21112	533,	96706-N8000	14334	789			789			
		576, 600	96706-P0105	14274	700,	9991-00-503	14313	700,			
94530438	23822	580,			761, 789, 824			761, 789			
		600, 637	96706-W1000	14267	748,	9991-00-601	14274	700,			
94530565	21070	494,			828			761, 789, 824			
		516, 725, 738	96706-W1099	14267	748,	9CF6-00-516B	22294	44,			
94530623	17267	556,			828			56, 92, 100			
		572, 676	9685057	11678	506,	9GG6-00-616T	22293	80,			
94530624	18119	559,			509			83			
		573, 715	97084563	24208	329	9N7Z-13N021-A	16897	288			
94530742	21316	590	9711304	15759	620	9N7Z-13N021-A	16898	288			
946-418	13220	115,	97134978	17355	437,	9N7Z-13N021-A	B9005	291			
		779, 805, 863			733	9T4Z-13466-A	B3157	290			
947-098	13230	524,	9716926	14549	624	9XGO-75-93X0	20190	503,			
		570, 775, 863	9721917	14550	624,			514			
94748652	22161	589			647	9XGI-10-37X0	20190	503,			
94841130	14277	825	972724	4244	430			514			
94841226	14750	113,	9731301	11152	436,						
		114, 147, 769, 848			437						
94841764	13932	782,	97519-22000	22557	723						
		824	97606-B0700	13930	761,						
94842841	18297	474,			789						
		512, 750, 831	977751	24317	306						
94847334	17383	526,	977751-7	24317	306						
		572, 601, 816, 840	9786454	9354	37						
94848834	15695	818	9786454	9355	37						
94849113	18297	474,	9786454	9356	37						
		512, 750, 831	9792217	23608	451,						
94852368	19140	558,			521						
		573, 599, 656,	9796223	10714	45,						
		676, 785, 845			62						
94853733	18939	546,	979878	19376	352						
		573, 754	979878-6	19376	352						
94854203	19194	584,	9806723	23761	623						
		827	9808241	10630	436						
94858299	18876	498,	9815325	14967	619,						
		512, 837			647, 662, 665						
94858338	19312	452,	9818648	10621	506,						
		513, 830			509						
94858343	19726	529,	9822198	14548	624						
		573, 599	982547	24262	319						
94858343	23935	580,	9828421	23676	588						
		840	9838109	10318	588						
94858509	19729	476,	9838109	11288	587						
		514, 751, 833	9854717	10631	436						
94858560	18873	547,	9854717	23956	436						
		573, 843	986833	24262	319						
94858864	19645	529,	9879002	23619	23						
		573, 599	9882774	8853	469,						
95005064	14144	499,			509						
		510, 838	9883583	10621	506,						
95008221	19129	502,			509						
		513, 839	9883583	11774	506,						
95022AC040ML	21630	454,			509						
		518, 811	9883583	16260	506,						
95188	15011	130			511						
95230842	21529	546,	9895598	10701	436						
		577, 605	989750	BH9	292						
95290	13173	850,	989826	B9005	291						
		862	989829	BH7	292						
95550-07000	25330	677,	989838	BH11	292						
		716	99045AE03AMA	21589	452,						
95550-07000	25330	677,			518, 811						
		716	99045SG000	22429	812						
95551-11000	25331	846	99132-12050	B168	290						
95551-15000	25332	847	9924-90-512B	14367	449,						
95551-15000	25332	847			510, 762						
95551-20000	25070	716	9926-40-531B	18271	475,						
9590477	12675	129			512, 763						
9591699	12695	129	9926-40-543	14349	474,						
9601750	20562	619			510, 763, 794						
96057293	23961	522,	9926-50-625	14260	532,						
		590, 816			570, 599, 766, 841						
96057846	17162	532,	9926-50-635	14369	550,						
		572, 601, 841			570, 767						
96057847	17383	526,	9927-40-821	14363	505,						
		572, 601, 816, 840			510, 765						
96061699	14367	449,	9927-40-822	16778	505,						
		510, 762			511, 765, 835						
96064506	19128	550,	9927-40-825	14269	498,						
		573, 844			510, 733, 764, 838						
9616231	23610	42	9927-80-404	14365	768						
9662950	11067	436	9927-80-405	14359	768						

BODY HARDWARE DEFINITIONS AND USAGE

Barrel Nuts: They are used with either stud-type or threaded fasteners where the other side of the panel is inaccessible. Typical applications include automotive nameplates on fenders, trunks, etc. The nut snaps into a pre-drilled hole and the metal tabs lock it into place. Also called tubular nuts.



Body Bolts: Usually either a hex washer head or hex head Sems® with the most common thread types being USS coarse or metric regular pitch. They are used for attachment of fenders, radiators, hoods, trunks and general purpose fastening.



Bumper Bolts: Used to attach bumpers. They have either a USS coarse or metric regular pitch thread. Bumper bolts are usually zinc plated with a stainless steel capped head.



Cable Straps (Releasable): Made of either natural or black nylon. Used to bundle wires or harnesses. With a releasable tab that allows you to loosen or tighten the strap as needed.



Door Hinge Pins & Bushings: Components of the vehicle's door hinge assembly. Pins are made of steel or stainless steel. The bushings are made of bronze. The critical dimensions of the pins are the length, the diameter and the shoulder diameter (if applicable). The critical dimensions of the bushings are the inside diameter and the outside diameter. Some bushings have a splined outside diameter.



Door Lock Rod Clips: Used to attach the door lock rod to the door lock cylinder. The clips are made of either steel or nylon.

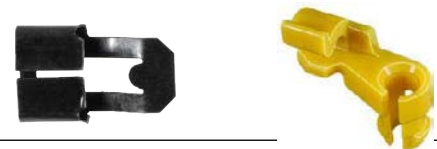

Door & Window Crank Handle Retaining Clip:

Usually made of copper plated spring steel, they are used to attach interior door and window crank handles.



Double End Drill Bits: For drilling holes for rivets or removing rivets. The double end feature gives you twice the "life" of the bit.



Extruded U-Nuts: Used on the edge of a panel so that the throat of the nut lines up with a hole in the panel. They allow for a certain degree of alignment before installation. The multi-thread feature gives it more strength and retention than a regular single thread U or J-nut. They have either a USS coarse thread or metric regular pitch thread. Extruded U-nuts are used with body bolts on door panels, hood hinges, fenders, radiators and for general purpose fastening.



Flat Nuts: Made of spring steel and used where the other side of the panel is easy to reach. They can be for either stud type or threaded fasteners. They are used throughout the car under the dashboard, in door panels, trunk area, fenders, etc.



Free Spinning Washer Nut: A hex nut with a captive free spinning washer. As the nut is tightened against a surface, a "wedging action" is produced to create a tight friction locking action. Some nuts may have grounding "teeth" on the underside of the washer. These nuts are available in both standard USS coarse and SAE fine thread as well as metric regular pitch. They are used with body bolts.



Headlight Adjusting Screw Assemblies: Two assemblies are usually required for each vehicle headlight. One assembly controls the vertical aiming and the other controls the horizontal aiming.



Headlight Component Retaining Clip: Used in the retention of Ford vehicle headlight components starting in 1989



Hex Flange Nuts: A standard hex nut with a "washer" permanently attached. Provides for greater retention than a standard hex nut because of the larger load bearing area.



Hood Adjusting Bolt & Bumper: A threaded steel bolt with a “captive” rubber bumper head. The bolt screws into the vehicle body and the rubber bumper portion softens the impact when the vehicle hood is closed.



J-Nuts: Shaped like the letter J. They are used the same as extruded U-nuts on the edge of a panel. Depending upon the thread size, they can be used with tapping screws or body bolts in instrument panels, under the hood for light-duty applications and door panels.



Expansion Nuts: For attaching outside rear view mirrors, roof racks, etc. They are installed into the sheet metal and then as a bolt is tightened, the body of the expansion nut collapses to form legs which grip the inside of the sheet metal. Auveco has a installation tool available for installing multiple nuts in a short period of time. Sometimes they have a plastisol sealer around the exposed part to form a water-tight seal.



License Plate Screws: Used to attach license plates. Can have either a tapping screw thread or a machine screw thread. Made of either steel (plated) or nylon.



Miscellaneous (Grille, Fascias, etc.) Fasteners: Usually made of steel and plated. There are numerous types of these fasteners that are used to attach radiator grilles, fascias, garnish moulding etc.



Moulding Clips: Used for attaching mouldings on doors, quarter panels, trunks, etc. They are made of nylon and are sometimes attached with a rivet or with a special tapping screw.

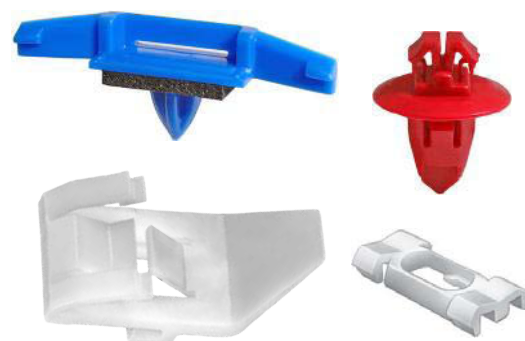

Nylon Nuts: Used with metal tapping screws throughout the car (interior & exterior) for attachment. As a tapping screw is installed, it cuts its own thread and spreads the bottom part of the nut apart securing it in place. Nylon nuts can be found in door panels, headlight/front-end applications, license plate brackets, arm rests, instrument panels and many other areas.



Push-On Retainers: A spring steel fastener that is pushed onto a non-threaded stud to grip it firmly.



Push-Type Retainers: They work by pushing in the center pin which spreads the prongs. They are used for retaining bumper guards, various fascia, splash shields, shrouds, etc. While they are designed to be reusable, they are made of nylon and are usually destroyed in a collision. They are sometimes referred to as rivet retainers or drive-type retainers.



Plug Buttons: Made of black polyethylene. They are used to plug holes in body panels.



Pushnut Bolt Retainers: A spring steel fastener that is pushed onto a screw or bolt to temporarily hold it in place until final assembly. They slide down smoothly on either fine, coarse or regular pitch threads and hold firmly at any point.



Retaining Clips: Used for retaining door panels, interior trim, hood insulation, weatherstrip, splash guards, headliners and various fascia. Although OEM interior retainers come in a large variety of colors, the aftermarket parts are usually black or natural nylon. The body shop paints them to match the application as needed. There are several different variations of design. These parts are usually destroyed when removed.



Reveal Moulding Clips: Used for attaching reveal moulding around windshields, back and side windows. Clips are held in place with a tapping screw, stud or rivet. The moulding snaps onto the clip.



Rivets: Used for attachment in many different areas. The critical dimensions are the diameter of the rivet body and the grip range or panel thickness. There's no way to determine what the grip range is by measuring the rivet. That's an engineered specification that has to be given. Rivets can be made of steel, stainless steel, aluminum or nylon (usually black). The mandrel is the part that breaks off when the rivet is installed.



Rubber Caps: Made of special heat resistant EPDM rubber. Used for capping lines and hoses when testing carburetors, emission control systems, vacuum lines, etc. and to cover exposed threads.



Screw Grommets: A variation of the nylon nut. They are used with metal tapping screws throughout the vehicle (interior and exterior). They're installed in a pre-punched hole or slot in sheet metal. The tapping screw cuts its own thread as it's installed. They are mostly found in Japanese cars.



Sems®: A screw/bolt with a free spinning washer attached to it. As the screw is tightened a "wedging action" is produced to create a tight friction locking action. The Sems® feature is found on both body bolts and tapping screws.



Shims: Made of low carbon, non-heat treated steel. They are used for wheel alignment as well as spacers in the alignment of hoods, panels, etc. The critical dimensions are the thickness (1/64", 1/32", 1/16", 1/8") and the slot width.



Speed Nut: A term for a variety of types of nuts. Refer to flat nuts, barrel nuts, U-nuts, J-nuts, tubular nuts and extruded U-nuts.



Spin Lock Nuts: A hex flange nut with serrations under the flange for locking purposes. The serrations or grooves dig into the bearing surface during final tightening. They are used with body bolts.



Tapping or Trim Screws: Generally used for retention of interior and exterior mouldings, trim, dash panels, etc. Can be used with nylon nuts, screw grommets or installed directly into sheet metal. They cut or form a thread when driven into a performed hole. There are many varieties available - Phillips flat top washer head, pan head, Phillips oval head, hex head, hex washer head, etc. you can have Phillips oval head screws with undersized heads such as a #8 screw with a #6 head. Such a screw is used where the original fasteners was a #6 screw but now needs to be replaced with a #8 screw yet the application still requires a #6 head.



Teks®: A screw with a drill point that drills its own hole as it is installed. Most Auveco Teks® screws have a #2 point which is recommended for material up to .110" thick. The higher the drill point number, the thicker that material it can drill through. Once the metal is penetrated, the Teks® fastener functions as a conventional tapping screws.

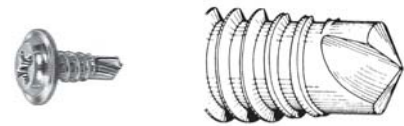

Thread Cutting Nuts: A flanged type fastener nut with a hex drive that cuts its own thread when installed on a mild steel, brass, aluminum or plastic stud. Because of their prevailing torque, they provide excellent vibration resistance. They can be found on instrument panels, trunk area, fenders, door panels, etc.



Torx®: A drive system on screws and bolts that features six points. Can be either an internal or external Torx®. The Torx® system is a more positive drive system than a Phillips or slotted.



Trim Panel Clips & Fasteners: Can be made of metal or nylon. Used for retaining door and interior trim panels. The head of the fastener slides into a slit in the trim panel and then the fastener stem is pushed into a hole in the sheet metal. These parts are often damaged when removed.



Tubular Nuts: They are used with either stud-type or threaded fasteners where the other side of the panel is inaccessible. Typical applications include automotive nameplates on fenders, trunks, etc. The nut snaps into a pre-drilled hole and the metal tabs lock it into place. They are also called barrel nuts.



U-Nuts: Used the same as extruded U-nuts, on the edge of a panel, but do not possess the same “retention power” due to the lack of the extruded feature. Depending upon the thread size, can be used with tapping screws or body bolts in door panels, under the dash and light duty under the hood applications.



Universal Moulding Fasteners: A universal type of fastener for attaching older style mouldings that have lips or curls on the underside. The spring steel arm provides the tension holding the moulding strip. With the perforated plate type, you can break off the plate at 1/16” intervals to fit the moulding. You need to be able to access the back of the panel so you can install a hex nut.



Washer Head: A screw/bolt with the washer permanently attached to it. Also called flanged head. The washer head eliminates the need for a separate washer while increasing the load bearing area of the head. Used under the hood, on fenders, doors, front end applications, etc.



Washer Lock Nuts: Integral washers on these fasteners span slots or clearance holes. The spring locking action and the resilience of the washer provides a firm fastening when assembled with a screw or bolt. They are used in instrument panels, doors, trunks, etc.



Well Nuts: Primarily used to attach luggage racks but ideal for many other applications. Consists of a flanged neoprene rubber bushing with a brass machine nut molded into one end. Tightening a conventional machine screw threaded in the brass nut causes the insert to expand, making a secure fastening.



Wire Loom Clips: Used to hold wire loom (split flexible tubing) in place on underhood applications.



“Xmas Tree” Retainers: Used for retaining door panels, interior trim, hood insulation, weatherstrip, splash guards, headliners and various fascia. Although OEM interior retainers come in a large variety of colors, the aftermarket parts are usually black or natural nylon. The body shop paints them to match the application as needed. There are several different variations of design. The multi-head type twists into a slit on the trim panel and then the stem gets popped into a hole in the sheet metal. These parts are usually destroyed when removed.



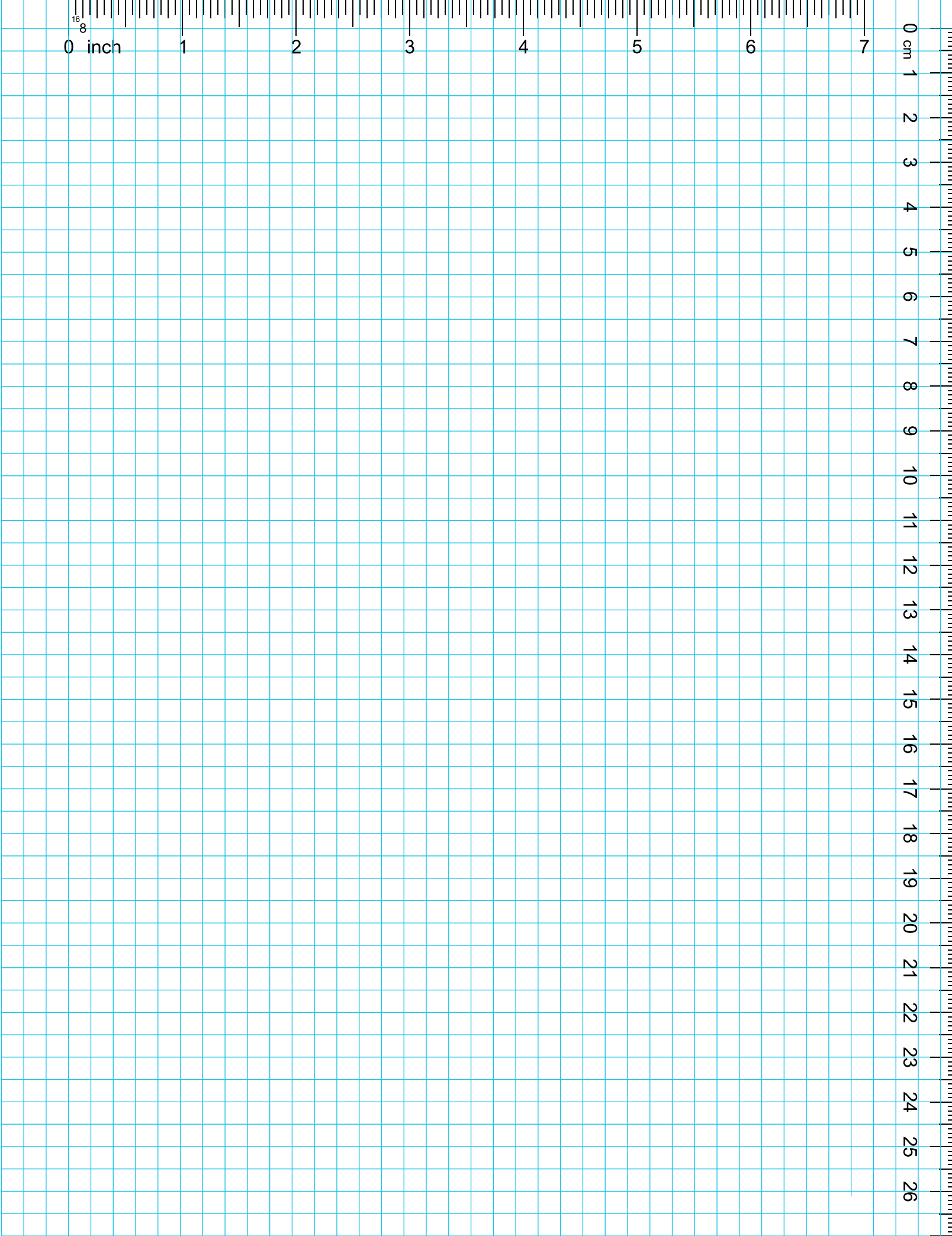
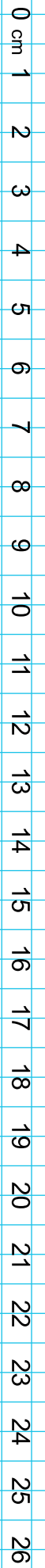
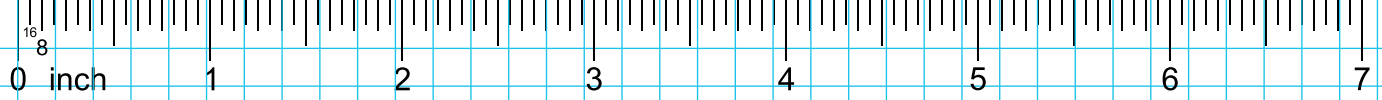

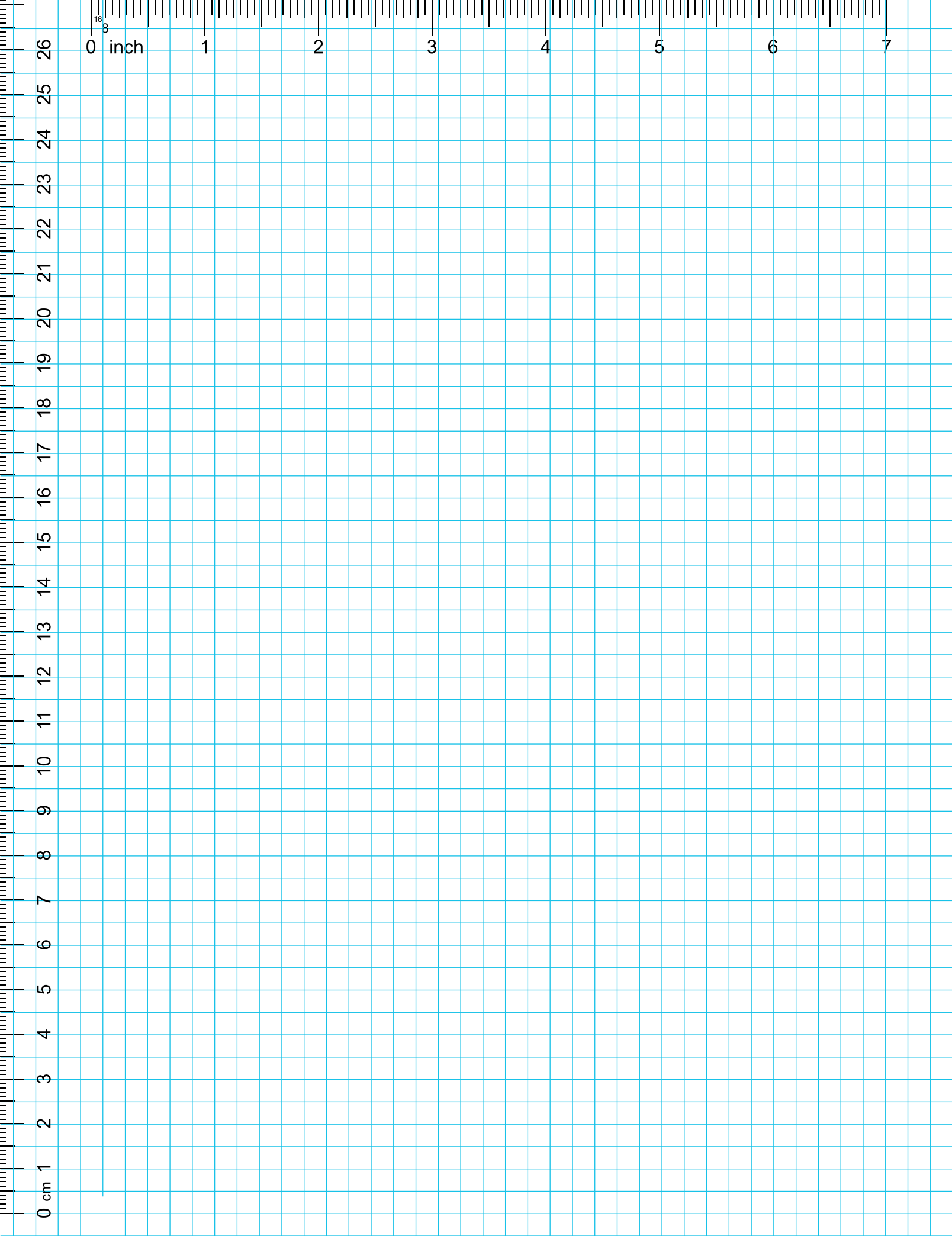

0 cm

1

2

3

4

5

6

7

8

9

10

11

12

13

14

15

16

17

18

19

20

21

22

23

24

25

26

0 inch

1

2

3

4

5

6

7

0 ¹⁶/₈ inch 1 2 3 4 5 6 7

0 cm 1 2 3 4 5 6 7 8 9 10 11 12 13 14 15 16 17 18 19 20 21 22 23 24 25 26

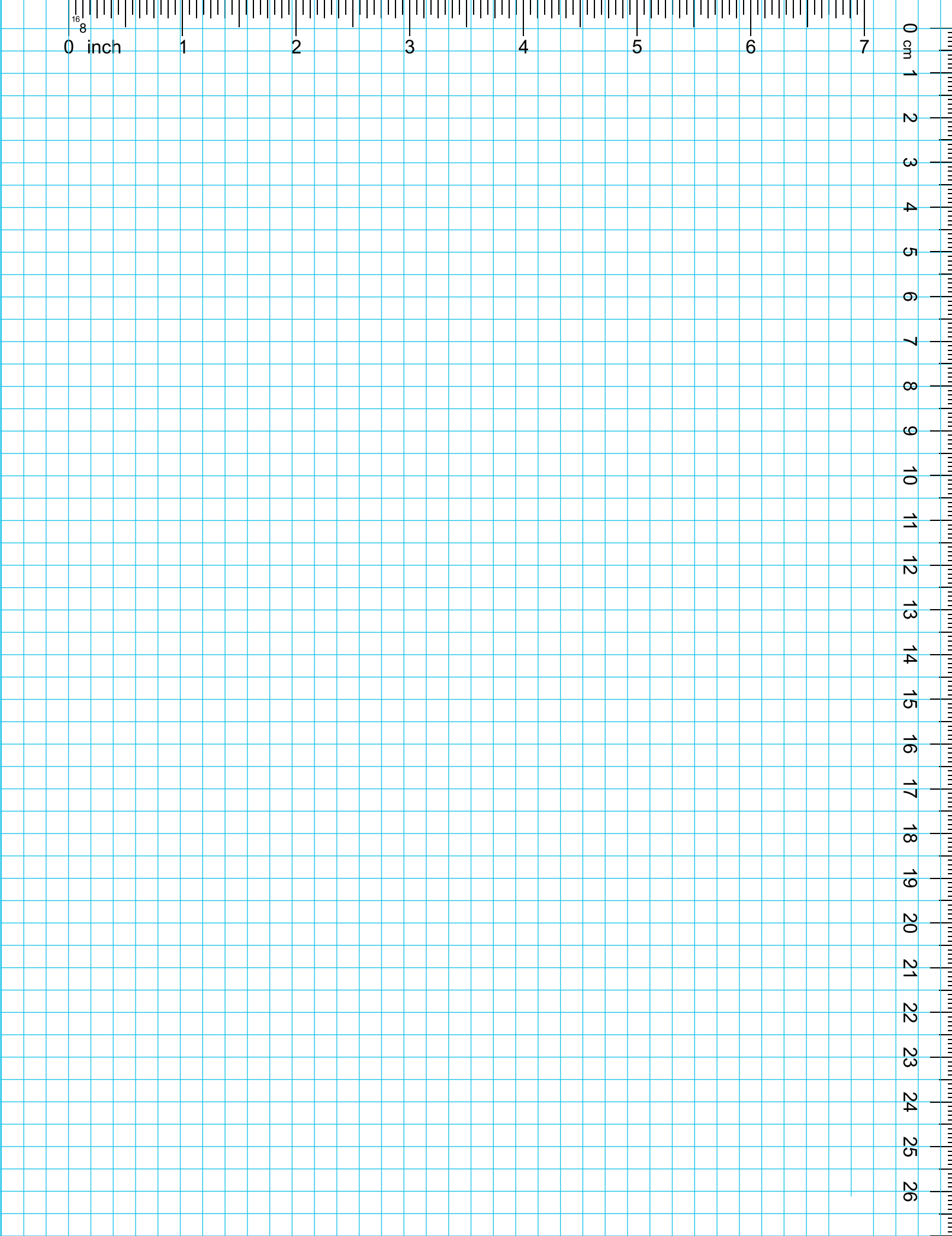

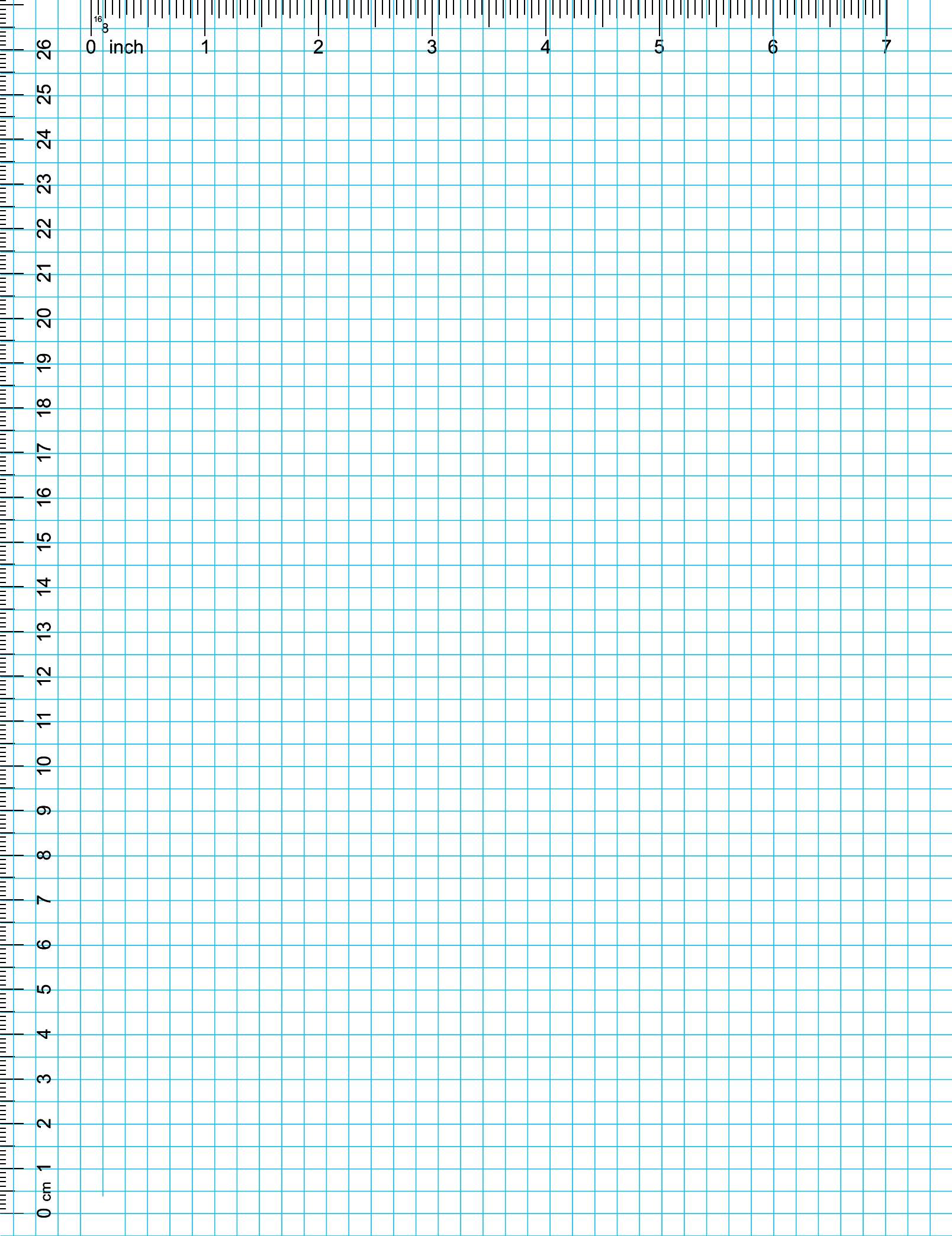

0 cm

1

2

3

4

5

6

7

8

9

10

11

12

13

14

15

16

17

18

19

20

21

22

23

24

25

26

0 inch

1

2

3

4

5

6

7

0 ¹⁶/₈ inch 1 2 3 4 5 6 7

0 cm 1 2 3 4 5 6 7 8 9 10 11 12 13 14 15 16 17 18 19 20 21 22 23 24 25 26

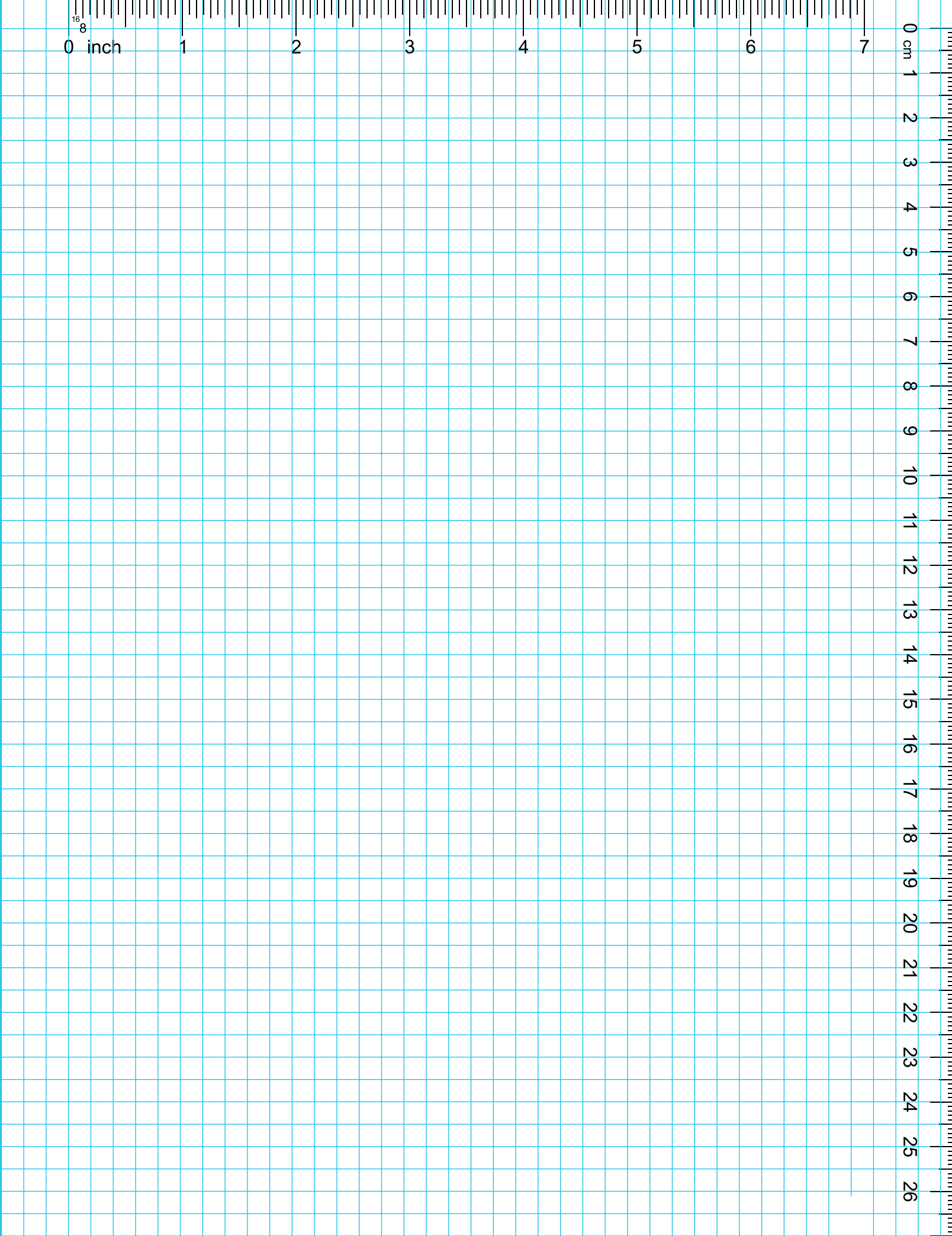

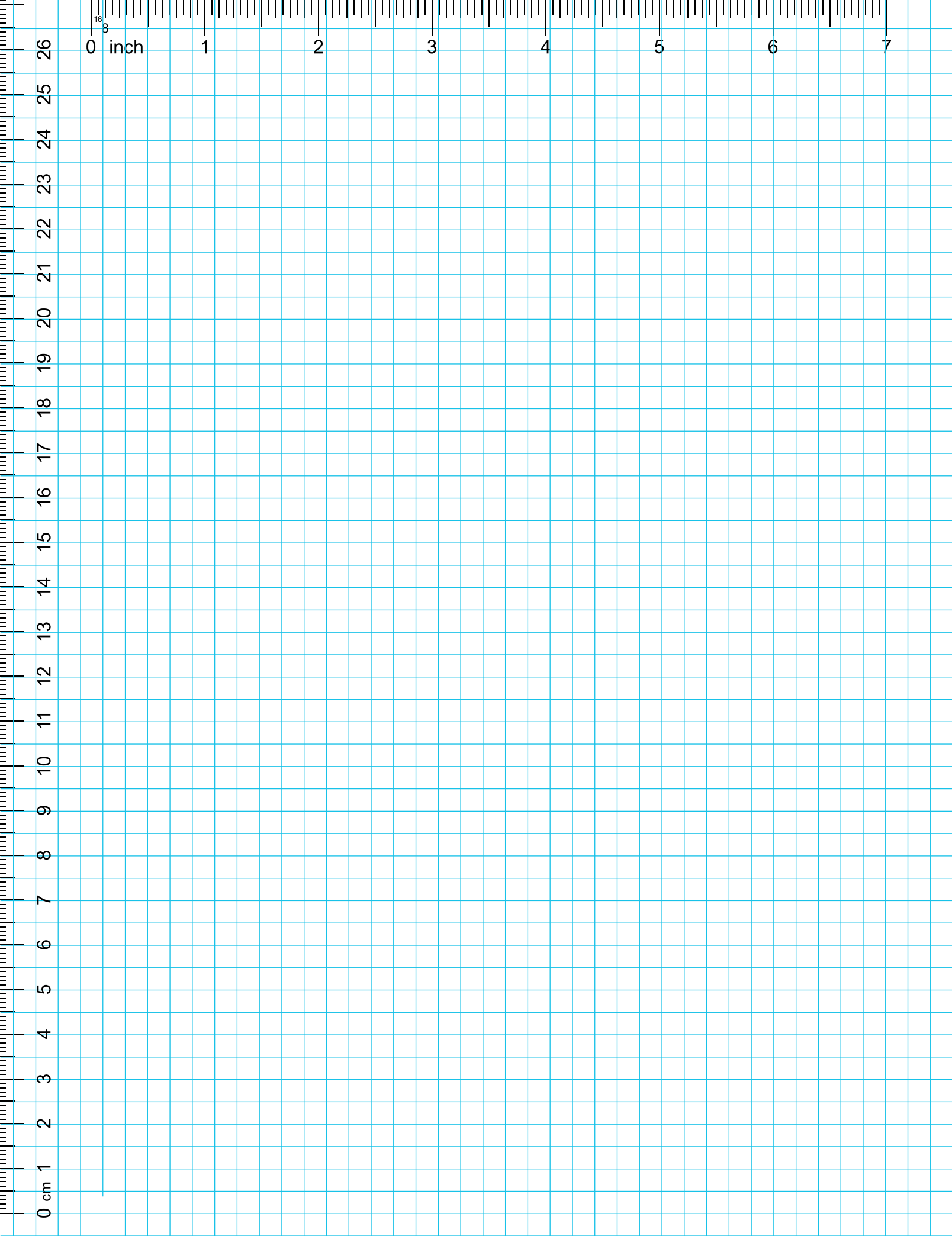

0 cm

1

2

3

4

5

6

7

8

9

10

11

12

13

14

15

16

17

18

19

20

21

22

23

24

25

26

0 inch

1

2

3

4

5

6

7

¹⁶/₃

Your Body Hardware and Specialty Fastener Solutions

Packaging



Unit Box Quantities



Bulk Quantities



AuvecoPak Retail Packs

Kits and Storage



Quik-Select Kits



Body Hardware Master
Kits and Storage Cabinet



Fix-Kits

Check out the Green Section 15 of our catalog for our full line of Body Hardware Master Kits, Quik-Select kits, Fix-Kits, and other assortments, where you'll also find our full AuvecoPak line and merchandiser. We also have several bins, cabinets, and other accessories to organize all your kits and fasteners.

FasTrack: Cost Recovery System

An easy-to-use, web-based system designed to assist body shops and dealerships in recovering the cost of body repair clips and fasteners used in daily collision repairs.

FasTrack is the ONLY supplemental invoicing system on the market using the OEM pricing structure that is widely accepted and requested by insurance companies across the country.

Start your free two-month trial today by visiting auveco.com

The Auveco logo consists of the word "Auveco" in a white, sans-serif font, centered within a green hexagonal shape. The background of the entire page is dark gray with a repeating pattern of lighter gray, stylized hexagonal shapes that resemble interlocking clips or fasteners.

Auveco

**SUPPLYING THE
LARGEST SELECTION
OF SPECIALTY CLIPS
AND FASTENERS.**

ESTABLISHED IN 1916
CINCINNATI, OHIO

 100 Homan Drive
Cold Spring, KY 41076

 auveco.com